

PLEASE CHECK WWW.MOLEX.COM FOR LATEST PART INFORMATION

Part Number: [0458440004](#)
Status: **Active**
Overview: edge card connectors
Description: 2.50mm (.098") Pitch EXTreme PowerEdge™, Signal Connector, Double Sided, 2 Segments (8 Signal Contacts Per Segment), Through Hole Solder for 1.57mm (.062") Thick PC Board

Documents:

[3D Model](#) [Product Specification PS-45719-001 \(PDF\)](#)
[Drawing \(PDF\)](#) [RoHS Certificate of Compliance \(PDF\)](#)

Agency Certification

CSA LR 19980
 UL E29179

General

Product Family Edge Card Connectors
 Series [45844](#)
 Component Type Edgecard to PCB
 Overview [edge_card_connectors](#)
 Product Name EXTreme PowerEdge™

Physical

Circuits (Loaded) 16
 Circuits (maximum) 16
 Circuits Detail All Signal
 Color - Resin Black
 Durability (mating cycles max) 250
 Entry Angle Vertical (Top Entry)
 Flammability 94V-0
 Keying to Mating Part N/A
 Material - Metal Phosphor Bronze
 Material - Plating Mating Gold
 Material - Plating Termination Tin
 Material - Resin High Temperature Thermoplastic
 PC Tail Length (in) 0.126 In
 PC Tail Length (mm) 3.19 mm
 PCB Thickness Recommended (in) 0.062 In
 PCB Thickness Recommended (mm) 1.60 mm
 Packaging Type Tray
 Pitch - Mating Interface (in) 0.098 In
 Pitch - Mating Interface (mm) 2.50 mm
 Plating min: Mating (µin) 30
 Plating min: Mating (µm) 0.75
 Plating min: Termination (µin) 150
 Plating min: Termination (µm) 3.75
 Temperature Range - Operating -40°C to +105°C
 Termination Interface: Style Through Hole

Electrical

Current - Maximum per Contact 3A
 Voltage - Maximum 250V

Solder Process Data

Duration at Max. Process Temperature (seconds) 5
 Lead-free Process Capability Wave Capable (TH only)
 Max. Cycles at Max. Process Temperature 1

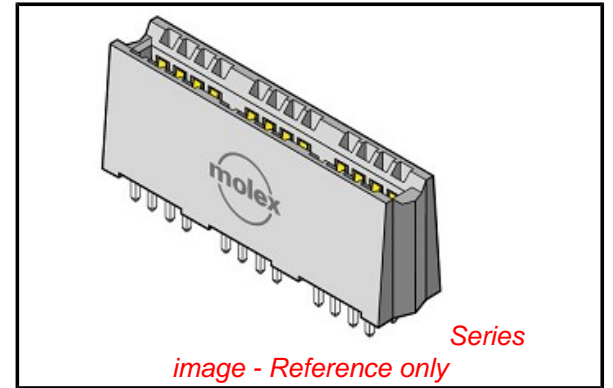

EU RoHS

**ELV and RoHS
 Compliant**
**REACH SVHC
 Contains SVHC: No**
**Halogen-Free
 Status**

China RoHS



**Need more information on product
 environmental compliance?**

Email productcompliance@molex.com
 For a multiple part number RoHS Certificate of
 Compliance, [click here](#)

Please visit the [Contact Us](#) section for any
 non-product compliance questions.

Search Parts in this Series

[45844Series](#)

Mates With

1.58mm (.062") double sided card edge

Process Temperature max. C 250

Material Info

Reference - Drawing Numbers

Packaging Specification	PK-45714-001
Product Specification	PS-45719-001
Sales Drawing	SD-45844-001

This document was generated on 06/04/2010

PLEASE CHECK WWW.MOLEX.COM FOR LATEST PART INFORMATION

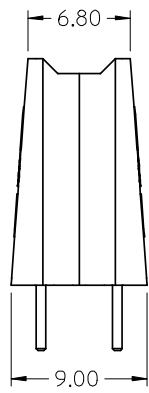
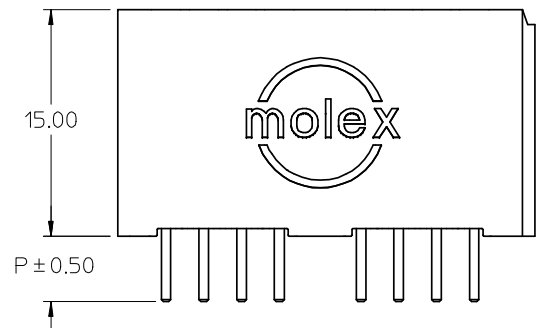
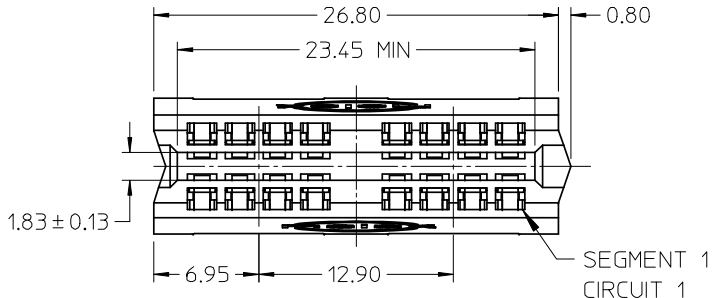

- NOTES:
- HOUSING MATL: LCP, UL94V-0, BLACK
TERMINAL MATL: COPPER ALLOY
 - FINISH: SELECT GOLD: 30 M.I. MIN IN CONTACT AREA
SELECT TIN: 150 M.I. MIN IN SOLDER AREA
BOTH OVER NICKEL: 50 M.I. MIN
 - PRODUCT SPECIFICATION: PS-45719-001.
 - PACKAGING SPECIFICATION: PK-45714-001.
 - PCB THICKNESS: SEE CHART
 - EDGE CARD THICKNESS: 1.57 ± 0.15
 - DIMENSIONS GIVEN ACROSS CENTERLINES ARE SYMMETRICAL ABOUT THOSE CENTERLINES WITHIN HALF THE TOTAL TOLERANCE.
 - 0.50 X 45° CHAMFER ON LEADING EDGE, TYP 4 SIDES.

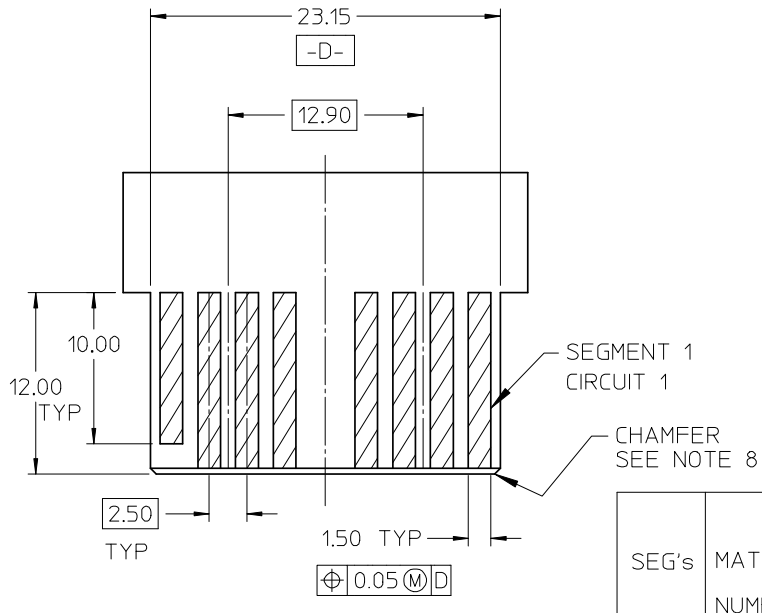
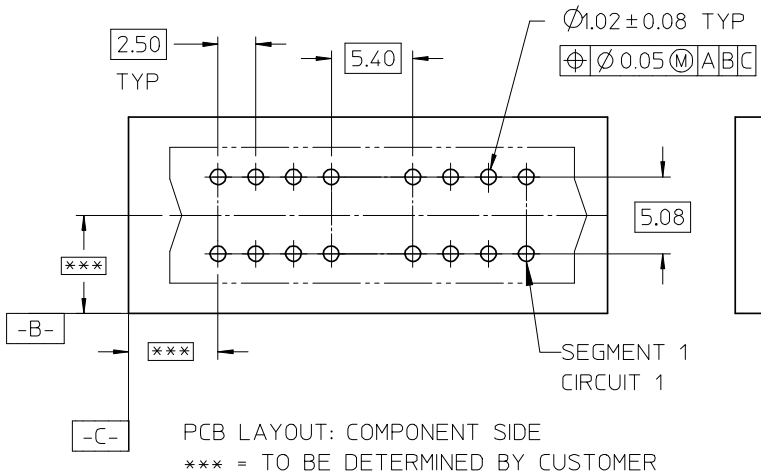

SEG's	MATERIAL NUMBER	DIM P	PCB THK
2	45844-0001	4.33	3.18/2.36
2	45844-0004	3.19	1.57

REVISE SLOT TOL.	2008/04/16
EC NO: UCP2008-2498	2008/04/22
DRWN: JSCHAER	2008/04/25
CHKD: CHKD:	
APPR: APATEL	
REV	DESCRIPTION

GENERAL TOLERANCES (UNLESS SPECIFIED)	
mm	INCH
4 PLACES ± ---	± ---
3 PLACES ± ---	± ---
2 PLACES ± 0.25	± ---
1 PLACE ± ---	± ---
ANGULAR ± 1/2°	
DRAFT WHERE APPLICABLE MUST REMAIN WITHIN DIMENSIONS	

DIMENSION STYLE	
MM ONLY	
DRAWN BY	DATE
MARGUL IS	2004/07/29
CHECKED BY	DATE
MARGUL IS	2004/07/29
APPROVED BY	DATE
MARGUL IS	2004/07/29
SEE CHART	

SCALE	DESIGN UNITS	THIRD ANGLE PROJECTION
2:1	METRIC	
TITLE		
POWER EDGE ASSEMBLY SIGNAL VERTICAL SOLDER TAIL		
MOLEX INCORPORATED		
DOCUMENT NO.	SHEET NO.	
SD-45844-001	1 OF 3	

6

5

4

3

2

1

SEE SHEET ONE FOR NOTES AND DIMENSIONS NOT SHOWN

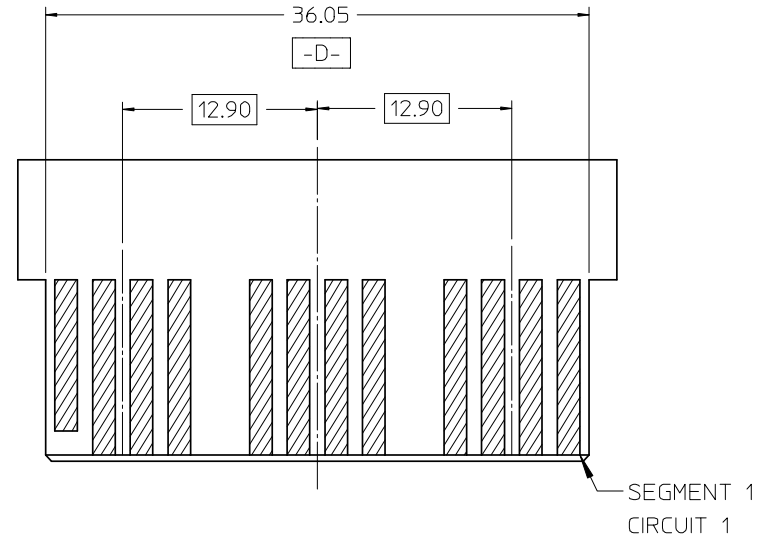
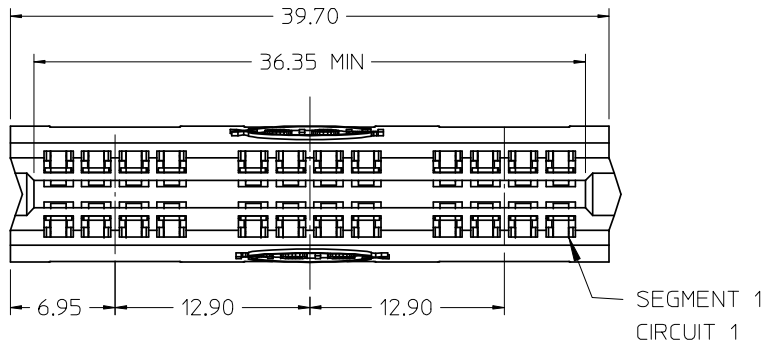

RECOMMENDED EDGE CARD LAYOUT:
TOLERANCE: ±0.05

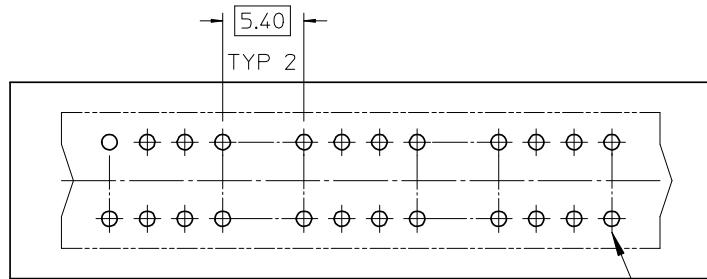
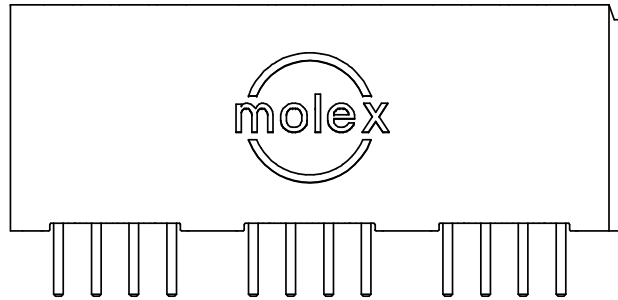

PBC LAYOUT: COMPONENT SIDE

SEG's	MATERIAL NUMBER	DIM P	PCB THK
3	45844-0002	4.33	3.18/2.36
3	45844-0005	3.19	1.57

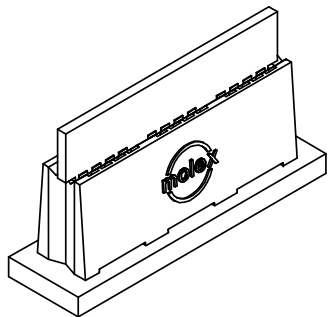

EC NO: UCP2008-2498	2008/04/16
DRWN: JSCHAER	2008/04/22
CHKD:	2008/04/25
APPR: APATEL	
DESCRIPTION	
REV	

GENERAL TOLERANCES (UNLESS SPECIFIED)		
	mm	INCH
4 PLACES	± ---	± ---
3 PLACES	± ---	± ---
2 PLACES	± 0.25	± ---
1 PLACE	± ---	± ---
ANGULAR ±1/2°		
DRAFT WHERE APPLICABLE MUST REMAIN WITHIN DIMENSIONS		

DIMENSION STYLE	
MM ONLY	
DRAWN BY	DATE
MARGULIS	2004/07/29
CHECKED BY	DATE
MARGULIS	2004/07/29
APPROVED BY	DATE
MARGULIS	2004/07/29
MATERIAL NUMBER	SEE CHART

SCALE	DESIGN UNITS	THIRD ANGLE PROJECTION
2:1	METRIC	
TITLE		
POWER EDGE ASSEMBLY SIGNAL VERTICAL SOLDER TAIL		
molex MOLEX INCORPORATED		
DOCUMENT NO.	SHEET NO.	
SD-45844-001	2	
THIS DRAWING CONTAINS INFORMATION THAT IS PROPRIETARY TO MOLEX INCORPORATED AND SHOULD NOT BE USED WITHOUT WRITTEN PERMISSION		

5

4

3

2

1

SEE SHEET ONE FOR NOTES AND DIMENSIONS NOT SHOWN

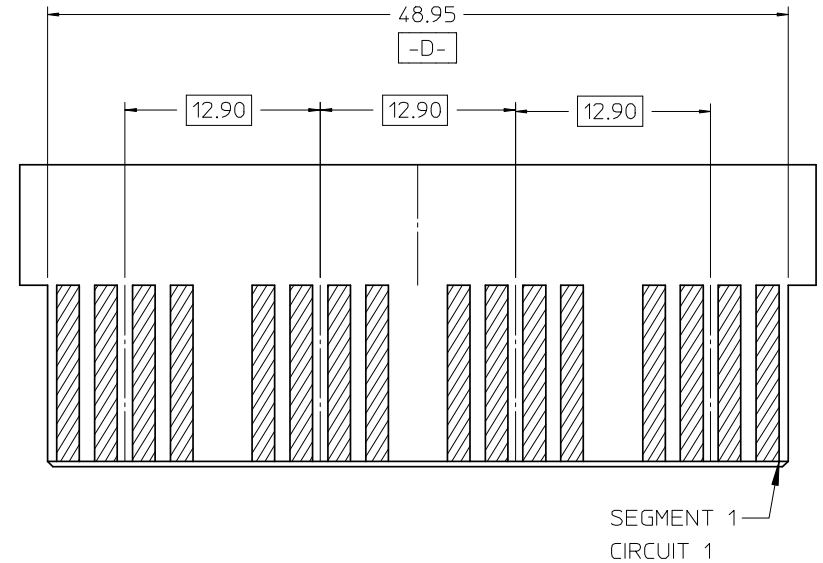

RECOMMENDED EDGE CARD LAYOUT
TOLERANCE: ±0.05

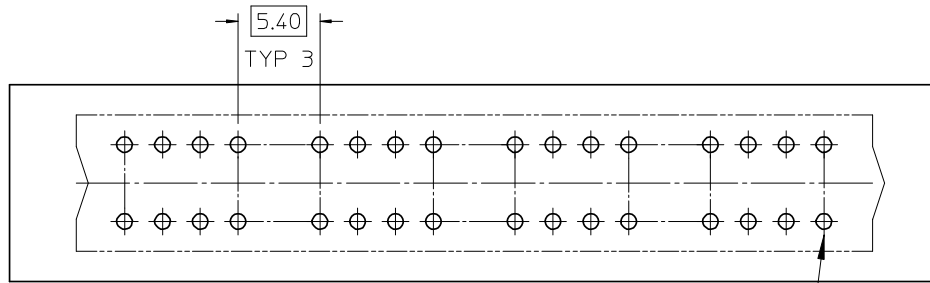
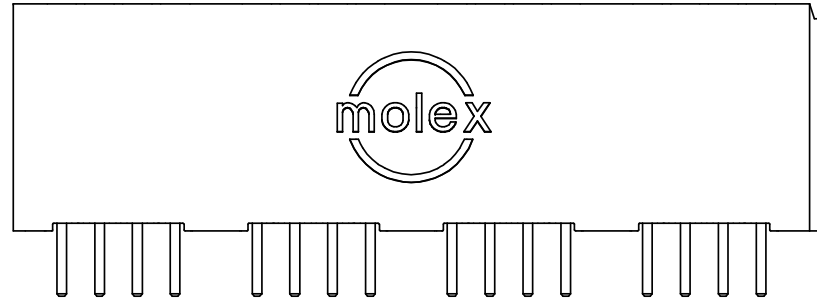

PCB LAYOUT: COMPONENT SIDE

SEG's	MATERIAL NUMBER	DIM P	PCB THK
4	45844-0003	4.33	3.18/2.36
4	45844-0006	3.19	1.57

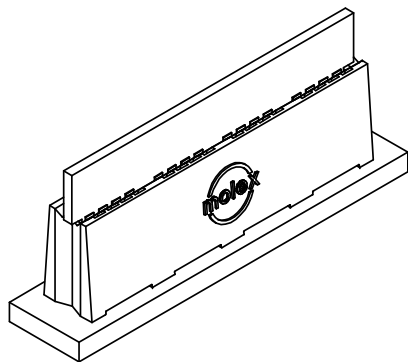

EC NO: UCP2008-2498	DRWN: JSCHAFFER	2008/04/16	2008/04/22
CH'KD: APPR: APATEL	2008/04/25		
REV	DESCRIPTION		
D			

GENERAL TOLERANCES (UNLESS SPECIFIED)

	mm	INCH
4 PLACES	± ---	± ---
3 PLACES	± ---	± ---
2 PLACES	± 0.25	± ---
1 PLACE	± ---	± ---

ANGULAR ±1/2°

DRAFT WHERE APPLICABLE
MUST REMAIN
WITHIN DIMENSIONS

DIMENSION STYLE
MM ONLY

DRAWN BY	DATE
MARGUL IS	2004/07/29
CHECKED BY	DATE
MARGUL IS	2004/07/29
APPROVED BY	DATE
MARGUL IS	2004/07/29
MATERIAL NUMBER	
SEE CHART	

SCALE
2:1

DESIGN UNITS
METRIC

THIRD ANGLE
PROJECTION

TITLE
POWER EDGE ASSEMBLY
SIGNAL VERTICAL
SOLDER TAIL

MoLEX MOLEX INCORPORATED
DOCUMENT NO. SD-45844-001
SHEET NO. 3

THIS DRAWING CONTAINS INFORMATION THAT IS PROPRIETARY TO MOLEX INCORPORATED AND SHOULD NOT BE USED WITHOUT WRITTEN PERMISSION

Компания «Океан Электроники» предлагает заключение долгосрочных отношений при поставках импортных электронных компонентов на взаимовыгодных условиях!

Наши преимущества:

- Поставка оригинальных импортных электронных компонентов напрямую с производств Америки, Европы и Азии, а так же с крупнейших складов мира;
- Широкая линейка поставок активных и пассивных импортных электронных компонентов (более 30 млн. наименований);
- Поставка сложных, дефицитных, либо снятых с производства позиций;
- Оперативные сроки поставки под заказ (от 5 рабочих дней);
- Экспресс доставка в любую точку России;
- Помощь Конструкторского Отдела и консультации квалифицированных инженеров;
- Техническая поддержка проекта, помощь в подборе аналогов, поставка прототипов;
- Поставка электронных компонентов под контролем ВП;
- Система менеджмента качества сертифицирована по Международному стандарту ISO 9001;
- При необходимости вся продукция военного и аэрокосмического назначения проходит испытания и сертификацию в лаборатории (по согласованию с заказчиком);
- Поставка специализированных компонентов военного и аэрокосмического уровня качества (Xilinx, Altera, Analog Devices, Intersil, Interpoint, Microsemi, Actel, Aeroflex, Peregrine, VPT, Syfer, Eurofarad, Texas Instruments, MS Kennedy, Miteq, Cobham, E2V, MA-COM, Hittite, Mini-Circuits, General Dynamics и др.);

Компания «Океан Электроники» является официальным дистрибьютором и эксклюзивным представителем в России одного из крупнейших производителей разъемов военного и аэрокосмического назначения «JONHON», а так же официальным дистрибьютором и эксклюзивным представителем в России производителя высокотехнологичных и надежных решений для передачи СВЧ сигналов «FORSTAR».



JONHON

«JONHON» (основан в 1970 г.)

Разъемы специального, военного и аэрокосмического назначения:

(Применяются в военной, авиационной, аэрокосмической, морской, железнодорожной, горно- и нефтедобывающей отраслях промышленности)

«FORSTAR» (основан в 1998 г.)

ВЧ соединители, коаксиальные кабели, кабельные сборки и микроволновые компоненты:

(Применяются в телекоммуникациях гражданского и специального назначения, в средствах связи, РЛС, а так же военной, авиационной и аэрокосмической отраслях промышленности).



Телефон: 8 (812) 309-75-97 (многоканальный)

Факс: 8 (812) 320-03-32

Электронная почта: ocean@oceanchips.ru

Web: <http://oceanchips.ru/>

Адрес: 198099, г. Санкт-Петербург, ул. Калинина, д. 2, корп. 4, лит. А