

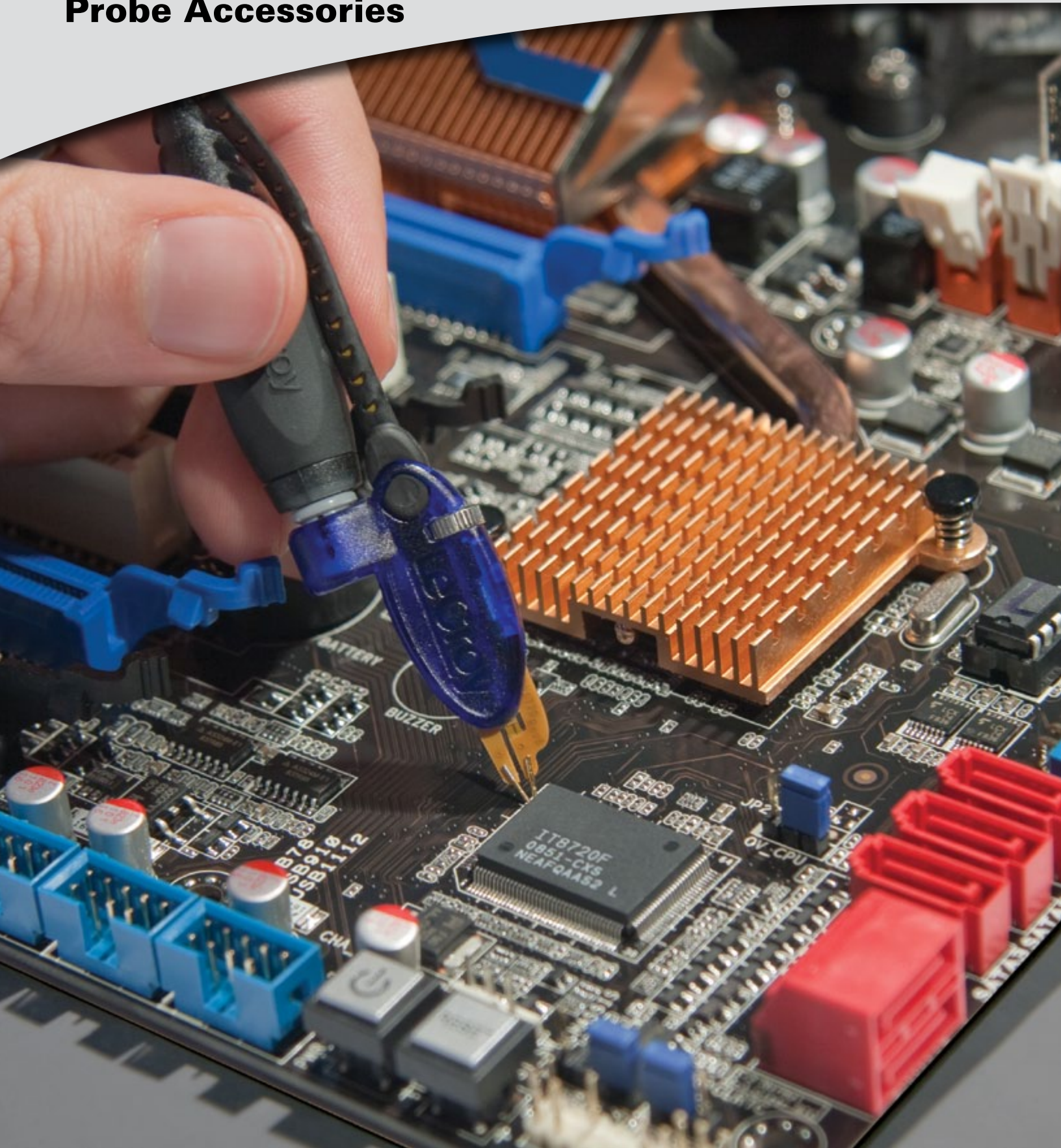

## Oscilloscope Probes and Probe Accessories



# PROBE SELECTION GUIDE

LeCroy has a wide variety of world class probes and amplifiers to compliment its product line. From the ZS high impedance active probes to the WaveLink differential probing system which offers bandwidths up to 25 GHz, LeCroy probes and probe accessories provide optimum mechanical connections for signal measurement.

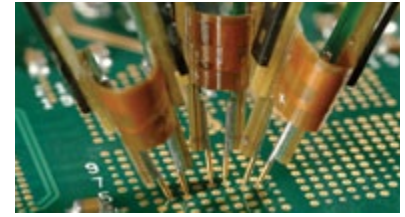

Front Cover:  
Dxx10-PT Differential Positioner Tip for the WaveLink 4-6 GHz Probes.

	<i>WaveAce Oscilloscopes</i>	<i>WaveJet 300A Oscilloscopes</i>	<i>WaveSurfer MIXs-B / MSO MIXs-B Oscilloscopes</i>	<i>HRO 12-bit Oscilloscopes</i>	<i>WaveRunner 6 Zi Oscilloscopes</i>	<i>WaveRunner Xi-A / MXi-A Oscilloscopes</i>	<i>Vehicle Bus Analyzers</i>	<i>WavePro/SDA/DDA/7 Zi/7 Zi-A Oscilloscopes</i>	<i>WaveMaster/SDA/DDA/8 Zi/Zi-A Oscilloscopes</i>	<i>LabMaster 9 Zi-A Oscilloscopes</i>	<i>LabMaster 10 Zi Oscilloscopes</i>
<b>Active Voltage Probes - p. 4 - 7</b>											
ZS1000		✓	✓	✓	✓	✓	✓	✓	✓	✓	✓
ZS1500		✓	✓	✓	✓	✓	✓	✓	✓	✓	✓
ZS2500				✓	✓	✓	✓	✓	✓	✓	✓
<b>Current Probes - p. 8 - 11</b>											
AP015		✓	✓	✓	✓	✓	✓	✓	✓	✓	✓
CP030		✓	✓	✓	✓	✓	✓	✓	✓	✓	✓
CP031		✓	✓	✓	✓	✓	✓	✓	✓	✓	✓
CP150		✓	✓	✓	✓	✓	✓	✓	✓	✓	✓
CP500		✓	✓	✓	✓	✓	✓	✓	✓	✓	✓
<b>Differential Probes - p. 12 - 23</b>											
ZD200		✓	✓	✓		✓	✓	✓	✓	✓	✓
ZD500		✓	✓	✓	✓	✓	✓	✓	✓	✓	✓
ZD1000		✓	✓	✓	✓	✓	✓	✓	✓	✓	✓
ZD1500		✓	✓	✓	✓	✓	✓	✓	✓	✓	✓
AP033		✓	✓	✓	✓	✓	✓	✓	✓	✓	✓
AP034		✓	✓	✓	✓	✓	✓	✓	✓	✓	✓
D410				✓	✓	✓	✓	✓	✓	✓	✓
D410-PT				✓	✓	✓	✓	✓	✓	✓	✓
D420				✓	✓	✓	✓	✓	✓	✓	✓
D420-PT				✓	✓	✓	✓	✓	✓	✓	✓
D500PT				✓			✓	✓	✓	✓	✓
D300A-AT				✓	✓	✓	✓	✓	✓	✓	✓
D600A-AT				✓			✓	✓	✓	✓	✓
D610				✓			✓	✓	✓	✓	✓
D610-PT				✓			✓	✓	✓	✓	✓
D620				✓			✓	✓	✓	✓	✓
D620-PT				✓			✓	✓	✓	✓	✓
Dxx05-PT-KIT								✓	✓		
D830								✓	✓		
D830-PS								✓	✓		
D1030								✓	✓		
D1030-PS								✓	✓		
D1330								✓	✓		
D1330-PS								✓	✓		
WL-PLink-A								✓	✓	✓	✓
LPA-2.92								✓	✓	✓	✓
WL-2.92MM								✓	✓	✓	✓
D1305-A								✓	✓	✓	✓
D1305-A-PS								✓	✓	✓	✓
D1605-A								✓	✓	✓	✓
D1605-A-PS								✓	✓	✓	✓
D2005-A								✓	✓	✓	✓

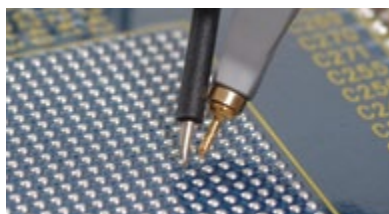

*WaveAce Oscilloscopes*  
*WaveJet 300A Oscilloscopes*  
*WaveSurfer MXs-B / MSO MXs-B Oscilloscopes*  
*HRO 12-bit Oscilloscopes*  
*WaveRunner 6 Zi Oscilloscopes*  
*WaveRunner Xi-A / MXi-A Oscilloscopes*  
*Vehicle Bus Analyzers*  
*WavePro/SDA/DDA/7 Zi/7 Zi-A Oscilloscopes*  
*WaveMaster/SDA/DDA/8 Zi/Zi-A Oscilloscopes*  
*LabMaster 9 Zi-A Oscilloscopes*  
*LabMaster 10 Zi Oscilloscopes*

<b>Differential Probes - p. 12 - 23 (cont'd)</b>											
D2005-A-PS									✓	✓	✓
D2505-A									✓	✓	✓
D2505-A-PS									✓	✓	✓
<b>High Voltage Differential Probes - p. 24 - 27</b>											
ADP300			✓	✓	✓	✓	✓	✓	✓	✓	✓
ADP305			✓	✓	✓	✓	✓	✓	✓	✓	✓
AP031	✓	✓	✓	✓	✓	✓	✓	✓	✓	✓	✓
<b>Differential Amplifiers - p. 28 - 31</b>											
DXC200			✓	✓	✓	✓	✓	✓	✓	✓	✓
DA101			✓	✓	✓	✓	✓	✓	✓	✓	✓
DA1855A			✓	✓	✓	✓	✓	✓	✓	✓	✓
DA1855A-PR2			✓	✓	✓	✓	✓	✓	✓	✓	✓
DA1855A-PR2-RM			✓	✓	✓	✓	✓	✓	✓	✓	✓
DA1855A-RM			✓	✓	✓	✓	✓	✓	✓	✓	✓
DXC-5100			✓	✓	✓	✓	✓	✓	✓	✓	✓
DXC100A			✓	✓	✓	✓	✓	✓	✓	✓	✓
<b>High Voltage Probes - p. 32 - 35</b>											
PPE1.2KV	✓	✓	✓	✓	✓	✓	✓	✓	✓	✓	✓
PPE20KV	✓	✓	✓	✓	✓	✓	✓	✓	✓	✓	✓
PPE2KV	✓	✓	✓	✓	✓	✓	✓	✓	✓	✓	✓
PPE4KV	✓	✓	✓	✓	✓	✓	✓	✓	✓	✓	✓
PPE5KV	✓	✓	✓	✓	✓	✓	✓	✓	✓	✓	✓
PPE6KV	✓	✓	✓	✓	✓	✓	✓	✓	✓	✓	✓
<b>Optical Probes - p. 36 - 39</b>											
OE425				✓	✓	✓	✓	✓	✓	✓	✓
OE455				✓	✓	✓	✓	✓	✓	✓	✓
OE525								✓	✓	✓	✓
OE555								✓	✓	✓	✓
OE695G									✓	✓	✓
<b>Passive Probes - p. 40 - 43</b>											
PP005A									✓		
PP006A		✓									
PP-007-WR-1							✓				
PP008-1				✓	✓						
PP009-1			✓	✓	✓						
PP010-1		✓									
PP011-1			✓								
PP016	✓										
<b>Transmission Line Probes - p. 44 - 47</b>											
PP065			✓		✓	✓	✓	✓	✓	✓	✓
PP066								✓	✓	✓	✓

Note: Some probes require purchase of the amplifier and platform/cable assembly separately – Reference detailed literature for more information.

# ACTIVE VOLTAGE PROBES

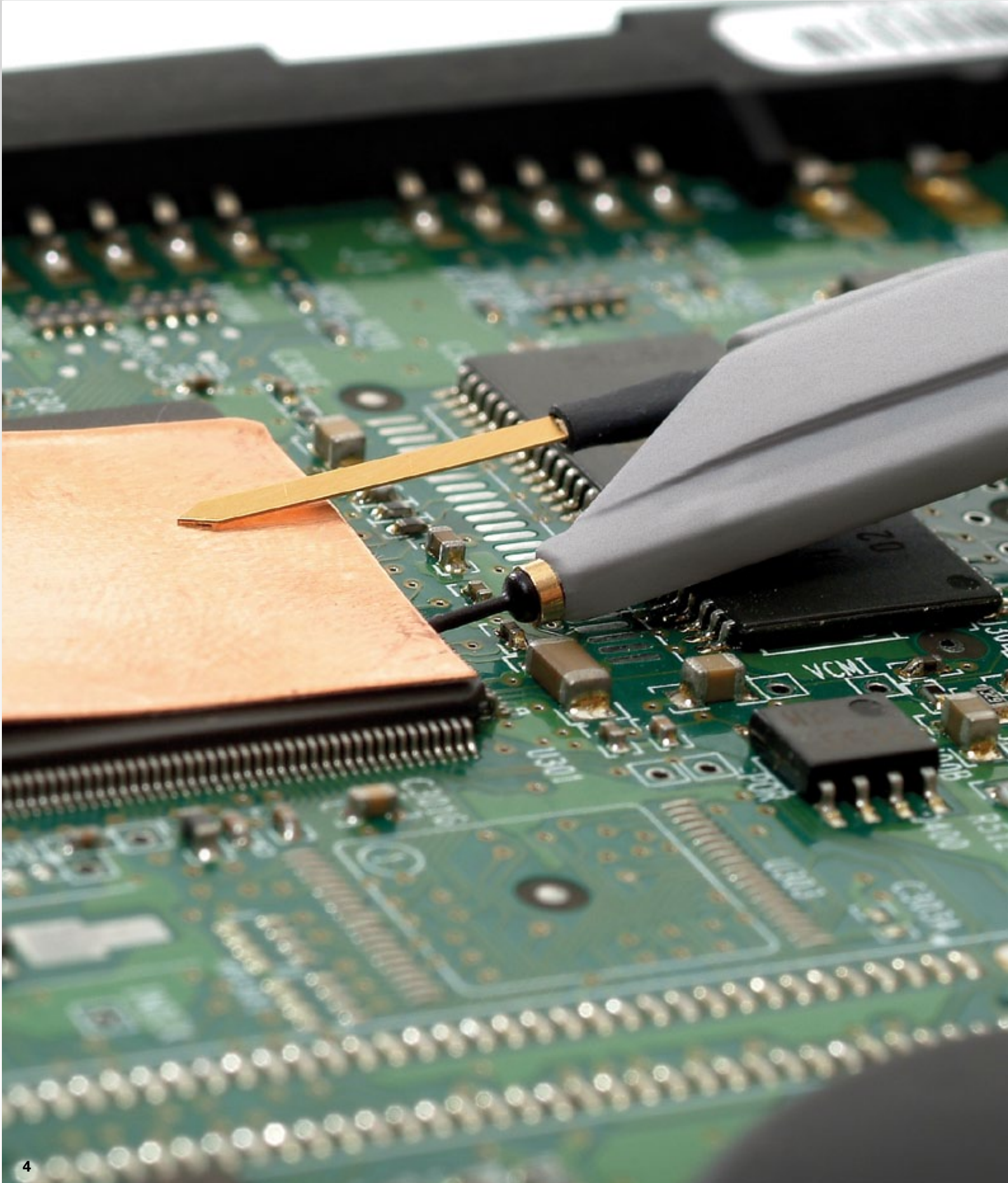

# ACTIVE VOLTAGE PROBES

**Engineers must commonly probe high-frequency signals with high signal fidelity. Typical passive probes with high input R and C provide good response at lower frequencies, but inappropriately load the circuit, and distort signals, at higher frequencies. Active voltage probes feature both high input R and low input C to reduce circuit loading across the entire probe/oscilloscope bandwidth. With low circuit loading, and a form factor that allows probing in confined areas, the active voltage probe becomes the everyday probe for all different types of signals and connection points.**

LeCroy Active  
Voltage Probes  
Model Numbers:

**ZS1000**

**ZS1500**

**ZS2500**

*Opposite page:  
ZS Series High Impedance Active Probe*

# ZS SERIES ACTIVE PROBES



LeCroy  
Active Voltage Probe  
Model Numbers:

**ZS1000**  
**ZS1500**  
**ZS2500**

The ZS Series probes provide high impedance and an extensive set of probe tips and ground accessories to handle a wide range of probing scenarios. The high 1 M $\Omega$  input resistance and low 0.9 pF input capacitance mean this probe is ideal for all frequencies. The ZS Series probes provide full system bandwidth for all LeCroy oscilloscopes having bandwidths of 2 GHz and lower.

## High Impedance Reduces Circuit Loading Across Full Oscilloscope Bandwidth

Engineers must commonly probe high frequency signals with high signal fidelity. Typical passive probes with high input R and C provide good response at lower frequencies, but inappropriately load the circuit, and distort signals, at higher frequencies. The ZS Series features both high input R (1 M $\Omega$  and low input C (0.9 pF) to reduce circuit loading across the entire probe/oscilloscope bandwidth. With low circuit loading, and a form factor that allows probing in confined areas, the ZS Series becomes the everyday probe for all different types of signals and connection points. The ZS1000 is ideal for 200–600 MHz oscilloscopes. The ZS1500 is ideal for 1 GHz oscilloscopes and the ZS2500 is ideal for 2 GHz oscilloscopes.

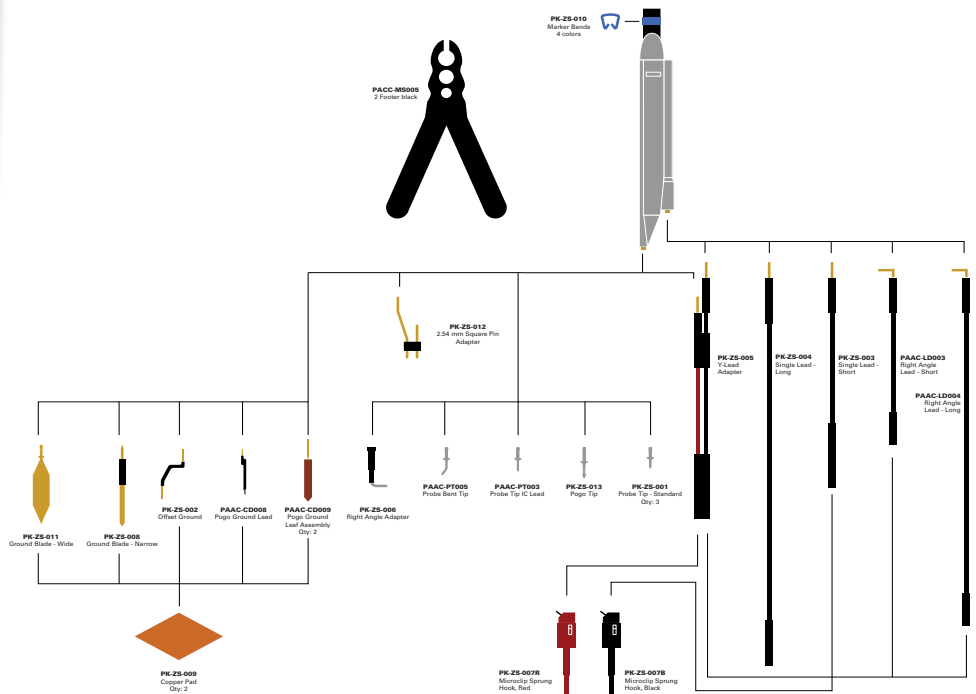

# ZS SERIES ACTIVE PROBES

## Specifications

### ZS1000

### ZS1500

### ZS2500

#### Electrical Characteristics

Bandwidth (Probe Only)	1 GHz	1.5 GHz	2.5 GHz
Bandwidth (System)	600 MHz at probe tip with 600 MHz oscilloscope	1 GHz at probe tip with 1 GHz oscilloscope	2 GHz at probe tip with 2 GHz oscilloscope
Input Capacitance	0.9 pF		
DC Input Resistance	1 M $\Omega$		
Probe Offset Range	N/A	$\pm 12$ V	
Attenuation	$\div 10$		
Input Dynamic Range	$\pm 8$ V		
Non-destruct Voltage	20 V		

#### General Characteristics

Cable Length	1.3 m
--------------	-------

## Ordering Information

#### Product Description

#### Product Code

Set of 4 ZS2500, 2.5 GHz, 0.9 pF, 1 M $\Omega$ High Impedance Active Probes	ZS2500-QUADPAK
Set of 4 ZS1500, 1.5 GHz, 0.9 pF, 1 M $\Omega$ High Impedance Active Probes	ZS1500-QUADPAK
Set of 4 ZS1000, 1 GHz, 0.9 pF, 1 M $\Omega$ High Impedance Active Probes	ZS1000-QUADPAK
2.5 GHz, 0.9 pF, 1 M $\Omega$ High Impedance Active Probe	ZS2500
1.5 GHz, 0.9 pF, 1 M $\Omega$ High Impedance Active Probe	ZS1500
1 GHz, 0.9 pF, 1 M $\Omega$ High Impedance Active Probe	ZS1000

#### Included with Standard Configuration

Instruction Manual, English	
Certificate of Calibration	
1-Year Warranty	
Straight Pin Lead – Short (Qty 1)	PK-ZS-003
Straight Pin Lead – Long (Qty 1)	PACC-LD004
Right Angle Pin Lead – Short (Qty 1)	PACC-LD003
Right Angle Pin Lead – Long (Qty 1)	PACC-LD004
Y Lead Adapter (Qty 1)	PK-ZS-005
Micro-Grabber Pair	PK-ZS-007R and PK-ZS-007B
Ground Blade – Wide	PK-ZS-011
Probe Tip – Standard (Qty 3)	PK-ZS-001
Right Angle Socket (Qty 1)	PK-ZS-006
Offset Ground – Z lead (Qty 1)	PK-ZS-002
Ground Blade – Narrow (Qty 1)	PK-ZS-008

#### Product Description

#### Product Code

#### Included with Standard Configuration (cont'd)

Copper Tape (Qty 2)	PK-ZS-009
Pogo Tip (Qty 1)	PK-ZS-013
2.54mm Square Pin Adapter	PK-ZS-012
Channel ID Clips (Set of 4 Colors)	PK-ZS-010
Freehand Probe Holder	PACC-MS005
Bent Tip (Qty 1)	PACC-PT005
IC Tip (Qty 1)	PACC-PT003
Pogo Ground Lead (Qty 1)	PACC-CD008
Pogo Leaf Ground Assembly (Qty 2)	PACC-CD009

#### Available Accessories

Discrete SMD Tip	PACC-PT004
Solder-In Ground	PACC-CD007
Ground Spring Hook	PACC-LD001
Square Pin Ground Spring	PACC-LD002

# CURRENT PROBES

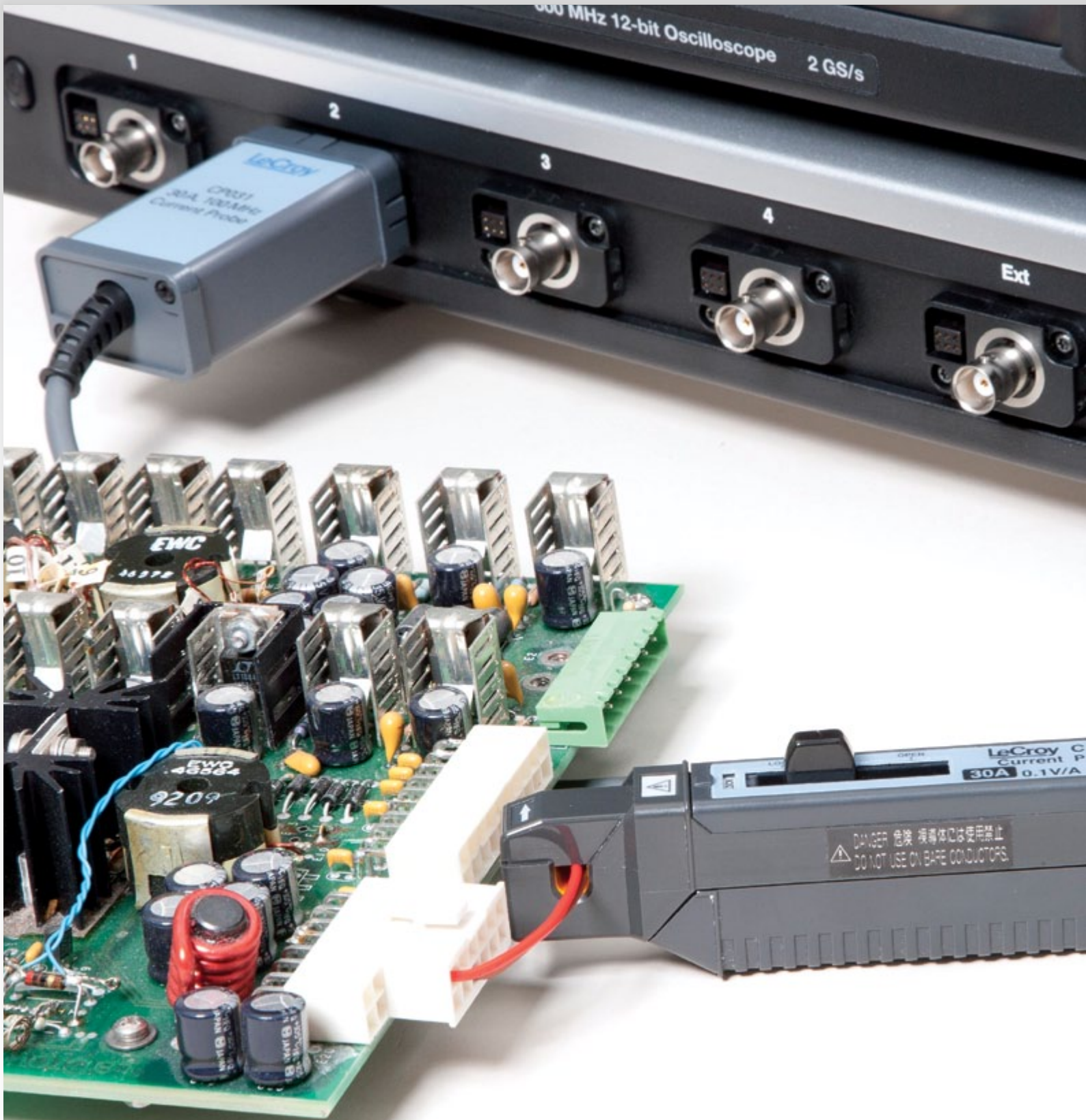



## Measuring AC and DC Currents

LeCroy current probes do not require the breaking of a circuit or the insertion of a shunt to make accurate and reliable current measurements. Based on a combination of Hall effect and transformer technology, LeCroy current probes are ideal for making accurate AC, DC, and impulse current measurements.

## Fully Integrated with Oscilloscope

Many current probes require external power supplies or amplifiers to display a waveform on the oscilloscope screen. All LeCroy current probes are powered through the LeCroy ProBus connection and require no additional hardware. Along with providing power, the ProBus connection allows the current probe and oscilloscope to communicate, resulting in current waveforms automatically displayed on screen in Amps, and calculated power traces scaled correctly in Watts. This full integration also allows for Degauss and Autozero functions to be done directly from the oscilloscope with a single button press.

## Applications

LeCroy current probes are available in a wide range of models for a wide range of applications. The full range of LeCroy current probes includes models with bandwidths up to 100 MHz, peak currents up to 700 A and sensitivities to 10 mA/div. Multiple current probes can be used together to make measurements on three-phase systems, or a single current probe can be used with a voltage probe to make accurate instantaneous power measurements. LeCroy current probes are often used in applications such as the design and test of switching power supplies, motor drives, electric vehicles, and uninterruptible power supplies.

LeCroy  
Current Probes  
Model Numbers:

**AP015**  
**CP030**  
**CP031**  
**CP150**  
**CP500**

*Opposite page:  
CP031, 30A, 100 MHz Current Probe.*

# CURRENT PROBES



LeCroy Current Probes  
Model Numbers:

- CP031**
- CP030**
- AP015 / DCS015**
- CP150**
- CP500**



## **CP031 – 30A, 100 MHz**

The CP031 is LeCroy's highest bandwidth current probe. Along with the high 100 MHz bandwidth the CP031 can probe continuous currents of 30  $A_{rms}$  and peak currents up to 50 A. The CP031 features a small form factor making it easier to probe on a crowded, compact board.



## **CP030 – 30 A, 50 MHz**

The CP030 was designed with a small form factor for today's crowded boards. The small jaw can probe currents in tight spaces and still clamp onto conductors up to 5 mm in diameter. Continuous currents of 30  $A_{rms}$  and peak currents of 50 A can be measured by the CP030, which also features a 50 MHz bandwidth.



## **AP015 – 30 A, 50 MHz**

The AP015 current probe can measure continuous current of 30  $A_{rms}$  and peak pulses of up to 50 A for durations up to 10 seconds. This probe also features an over-heating protection circuit, which will display an on-screen warning to the user to prevent damage. A probe unlock detection feature is also built in to the AP015 to ensure accurate measurements.



## **DCS015 – Deskew Calibration Source for AP015**

The DCS015 calibration source has both voltage and current time-aligned signals, which enables the precise deskew of voltage and current probes. Most voltage probes along with the CP031, CP030 and AP015 are compatible with the DCS015.

# CURRENT PROBES



## CP150 – 150 A, 10 MHz

Features:

- 150 Arms continuous current
- 500 A<sub>peak</sub>
- 10 MHz bandwidth

## CP500 – 500 A, 2 MHz

Features:

- 500 Arms continuous current
- 700 A<sub>peak</sub>
- 2 MHz bandwidth

## Specifications

	CP031**	CP030**	AP015	CP150	CP500
<b>Electrical Characteristics</b>					
Max. Continuous Input Current	30 A			150A	500 A
Bandwidth	100 MHz	50 MHz	50 MHz	10 MHz	2 MHz
Max. Peak Current at Pulse Width	50 A ≤ 10 μs		50 A ≤ 10 s	500 A ≤ 30 μs	700 A
Rise Time (typical)	≤ 3.5 ns	≤ 7 ns		< 35 ns	< 175 ns
Minimum Sensitivity	20 mA/div		10 mA/div	20 0mA/div	
Max. In-Phase Current				500 A	1150 A
Low-Frequency Accuracy	1%				
AC Noise	≤ 2.5 mA		-	≤ 25 mA	25 mA
Coupling	AC, DC, GND				

## General Characteristics

Cable Length	1.5 m		2 m		6 m
Weight	240 g		300 g		500 g
Max. Conductor Size (diameter)	5 mm		20 mm		
Interface	ProBus, 1 MΩ only†				
Usage Environment	Indoor				
Operating Temperature	0° C to 40° C				
Max. Relative Humidity	80%				
Max. Altitude	2000 m				
Maximum Insulated Wire Voltage	300 VCAT I, 150 V CAT II	300 VCAT I		600 VCAT I, 300 V CAT II	

\* Guaranteed at 23 °C ±3 °C

† The CP031 and CP030 are compatible with LeCroy X-Stream oscilloscopes running firmware version 4.3.1.1 or greater.

‡ Requires AP-1M for use with 50 Ω input only oscilloscopes

## Ordering Information

Product Description	Product Code	Product Description	Product Code
30 A; 100 MHz Current Probe - AC/DC; 30 A <sub>rms</sub> ; 50 A <sub>peak</sub> Pulse	CP031	150 A; 10 MHz Current Probe - AC/DC; 150 A <sub>rms</sub> ; 500 A <sub>peak</sub> Pulse	CP150
30 A; 50 MHz Current Probe - AC/DC; 30 A <sub>rms</sub> ; 50 A <sub>peak</sub> Pulse	CP030	500 A; 2 MHz Current Probe - AC/DC; 500 A <sub>rms</sub> ; 700 A <sub>peak</sub> Pulse	CP500
30 A; 50 MHz Current Probe - AC/DC; 30 A <sub>rms</sub> ; 50 A <sub>peak</sub> Pulse	AP015	Deskew Calibration Source for AP015	DCS015

# DIFFERENTIAL PROBES

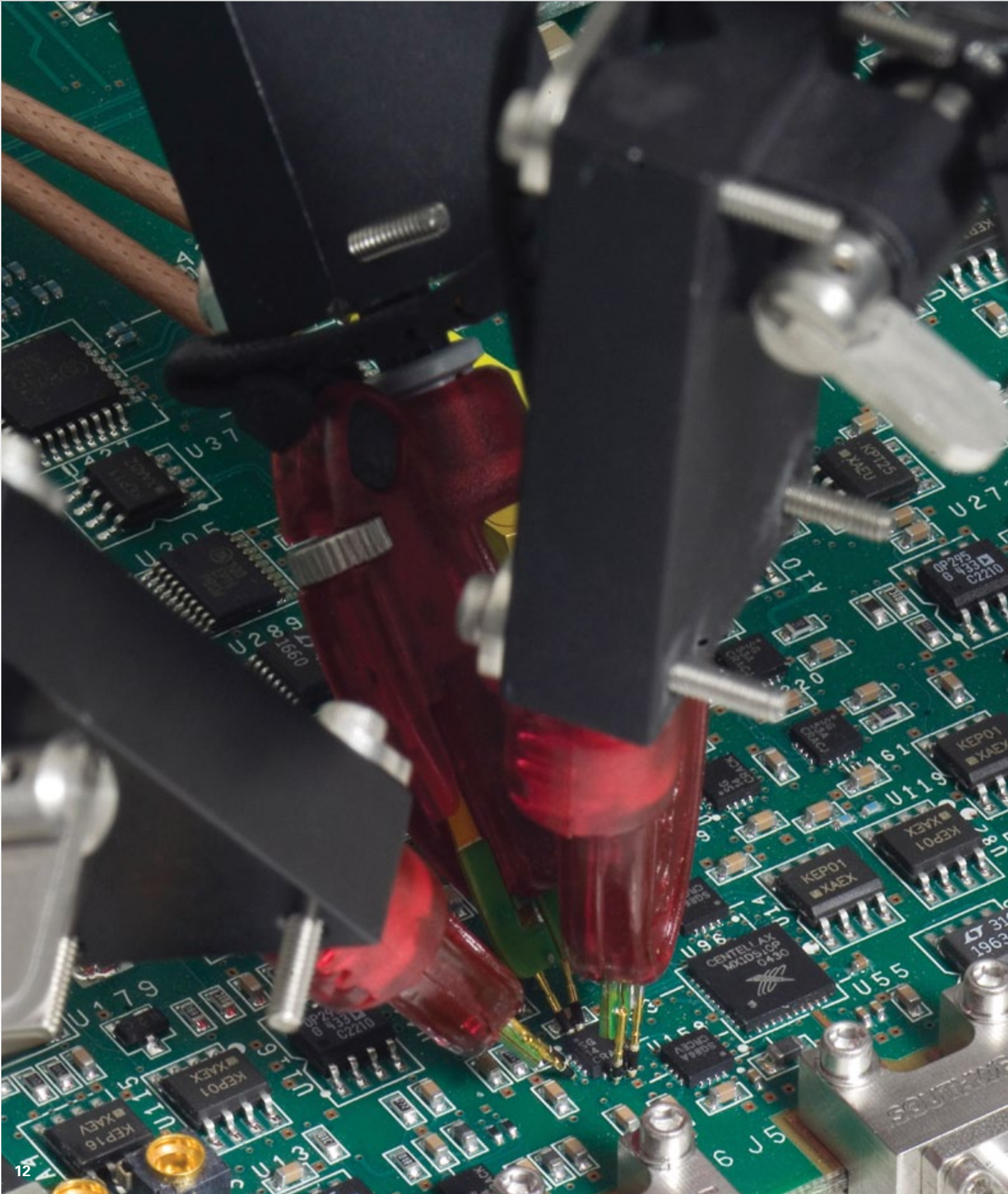

# DIFFERENTIAL PROBES

**Differential active probes are like two probes in one. Instead of measuring a test point in relation to a ground point (like single-ended active probes), differential probes measure the difference in voltage of a test point in relation to another test point.**

LeCroy  
Differential Probes  
Model Numbers:

**200 MHz - 1.5 GHz**

**ZD200**

**ZD500**

**ZD1000**

**ZD1500**

**AP033**

**AP034**

**3 GHz - 6 GHz**

**D300A-AT**

**D410**

**D420**

**D500PT**

**D600A-AT**

**D610**

**D620**

**8 GHz - 13 GHz**

**D830**

**D1030**

**D1330**

**11 GHz - 25 GHz**

**D1305-A**

**D1605-A**

**D2005-A**

**D2505-A**

*Opposite page:  
WaveLink® High Bandwidth Differential Probing System  
(13 GHz – 25 GHz)*

# ZD SERIES DIFFERENTIAL PROBES



LeCroy  
Differential Probe  
Model Numbers:

**ZD200**  
**ZD500**  
**ZD1000**  
**ZD1500**

The ZD Series probes provide wide dynamic range, excellent noise and loading performance and an extensive set of probe tips, leads, and ground accessories to handle a wide range of probing scenarios. The low 1 pF capacitance means this probe is ideal for all frequencies. The ZD Series differential probes provide full system bandwidth for all LeCroy Oscilloscopes 1.5 GHz and lower.

## Fully Integrated

With the ProBus interface, the ZD500, 1000, and 1500 becomes an integral part of the oscilloscope. All probe gain and offset controls are transparent to the user, making it easier to probe the circuit without concern for which gain setting to choose. When used with a LeCroy digital oscilloscope, no external power supply is required.

## Wide Dynamic Range

The ZD500, 1000, 1500 probes provides transparent probe attenuation so signals are always optimized for the display. The differential range is 18 V<sub>p-p</sub> with a differential offset of  $\pm 8$  and common mode range of  $\pm 10$  V, making this versatile for every probing application.

## Wide Applications

The wide dynamic range of 16 V<sub>p-p</sub> and offset range of  $\pm 8$  suit this probe to a wide range of applications and signal types. The ZD differential probes are ideally suited for Automotive, Serial Data, power, and general purpose use.

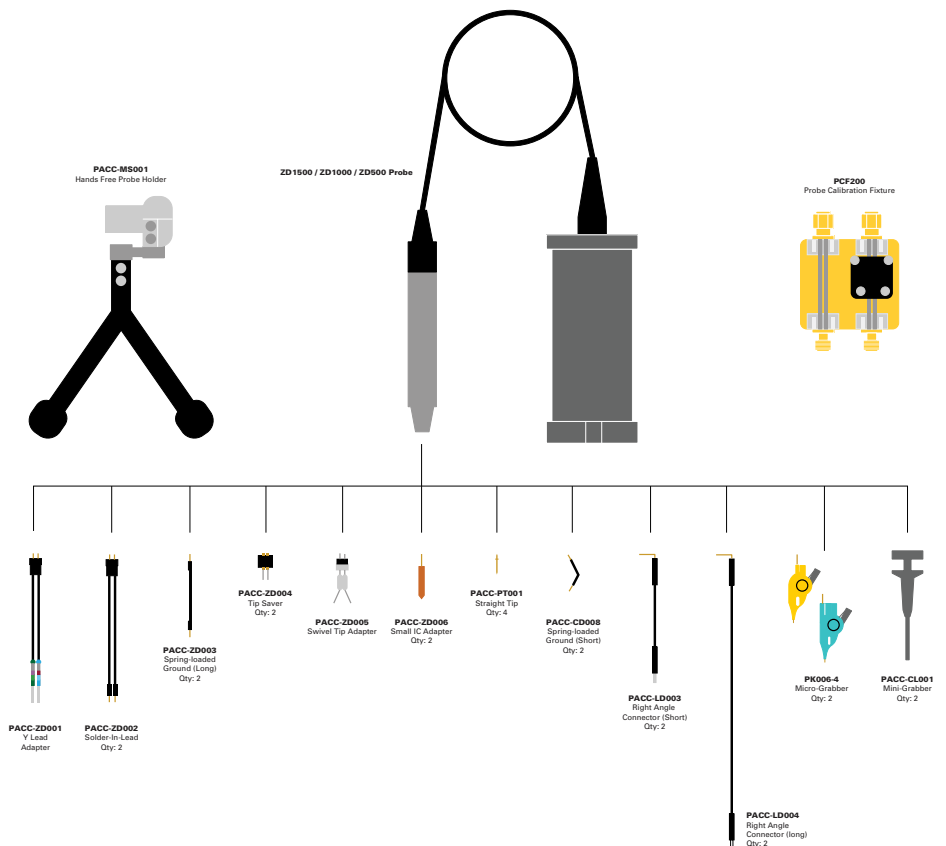

# ZD SERIES DIFFERENTIAL PROBES

## Specifications

	ZD1500	ZD1000	ZD500	ZD200
<b>Electrical Characteristics</b>				
Bandwidth (Warranted)	1500 MHz	1000 MHz	500 MHz	200 MHz
Bandwidth (Typical)	1700 MHz	1200 MHz	650 MHz	-
Risetime 10–90% (Typical)	270 ps	375 ps	650 ps	1.75 ns
Risetime 20–80% (Typical)	200 ps	280 ps	500 ps	-
LF Attenuation Accuracy (Warranted)		2%		1%
Zero Offset (Typical) (within 15 minutes after autozero)		5 mV		-
System Noise (Typical)	1.75 mV <sub>rms</sub>	1.75 mV <sub>rms</sub>	1.3 mV <sub>rms</sub>	-
Probe Noise Density (Typical)		38 nV/rt (Hz)		3 mV <sub>rms</sub>
Input Differential Range (Nominal)		±8 V (16 V <sub>p-p</sub> )		± 20 V
Differential Offset Range (Nominal)		±18 V		-
Offset Gain Accuracy (Typical)		2%		-
Common Mode Range (Nominal)		±10 V		± 60 V
Maximum Non-destruct Voltage (Nominal)		30 V		-
CMRR (Typical)	60 dB 50/60 Hz 30 dB 20 MHz 25 dB @ 1500 MHz	60 dB 50/60 Hz 30 dB 20 MHz 25 dB @ 1000 MHz	60 dB 50/60 Hz 30 dB 20 MHz 25 dB 500 MHz	80 dB @ 60 Hz 50 dB@10 MHz
DC Input Resistance (Nominal)		50 kΩ (Common Mode) 120 kΩ (Differential Mode)		250 kΩ (Common Mode) 1 MΩ (Differential Mode)
Differential Input Capacitance (Typical)		< 1.0 pF		3.5 pF

## Ordering Information

Product Description	Product Code	Product Description	Product Code
200 MHz, 3.5 pF, 1 MΩ Active Differential Probe	ZD200	Right Angle Connector Long, Qty 2	PACC-LD004
500 MHz, 1.0 pF, 1 MΩ Active Differential Probe	ZD500	Micrograbber, Qty 2	PK006-4
1 GHz, 1.0 pF, 1 MΩ Active Differential Probe	ZD1000	Minigrabber, Qty 2	PACC-CL001
1.5 GHz, 1.0 pF, 1 MΩ Active Differential Probe	ZD1500	Short Spring Loaded Bendable Ground, Qty 2	PACC-CD008
		Probe Calibration Fixture, Qty 1	PCF200
		ZD Replacement Kit	PK111
		Hands Free Probe Holder, Qty1	PACC-MS001

## Standard Accessories

Y Lead Adapter, Qty 1	PACC-ZD001
Solder-In Lead, Qty 2	PACC-ZD002
Long Spring Loaded Bendable Ground, Qty 2	PACC-ZD003
Tip Saver, Qty 2	PACC-ZD004
Swivel Tip Adapter	PACC-ZD005
Small IC Adapter, Qty 2	PACC-ZD006
Replacement Accessory Kit for ZD200	PACC-ZD007
Replacement Leadset for ZD200	PACC-ZD008
Straight Tip, Qty 4	PACC-PT001
Right Angle Connector Short, Qty 2	PACC-LD003

# WAVELINK LOW BANDWIDTH DIFFERENTIAL PROBES



LeCroy WaveLink  
Low Bandwidth Differential  
Probe and Accessory  
Model Numbers:

**D410**  
**D410-PT**  
**D420**  
**D420-PT**  
**D500PT**  
**D300A-AT**  
**D600A-AT**  
**D610**  
**D610-PT**  
**D620**  
**D620-PT**  
**WL-PBus**  
**WL-PLink**

WaveLink® probes provide industry leading technology for wideband signal connection to test instruments. The first differential probes to employ SiGe technology, they deliver full system bandwidth when used with WaveRunner®, WavePro®, WaveMaster®, DDA and SDA oscilloscopes up to 6 GHz.

WaveLink probes:

- Maintain good loading characteristics across the frequency span
- Optimized for gain, noise and bandwidth for optimal performance
- Offer broad range of dynamic range and noise over gain settings by incorporating automatic probe attenuation changes

WaveLink is the first differential probe to use a unique calibration process to achieve superb waveform fidelity for routine voltage measurements. Calibration coefficients “fine tune” the frequency response of each WaveLink probe and are individually determined during factory calibration and programmed into the probe. The SDA, DDA, WaveMaster, WaveRunner, or WavePro Series oscilloscopes read this data and use it to digitally compensate the entire system response for superior fidelity.

*4 GHz–6 GHz WaveLink configurations  
(compatible with oscilloscopes  
from 4 GHz to 6 GHz)*

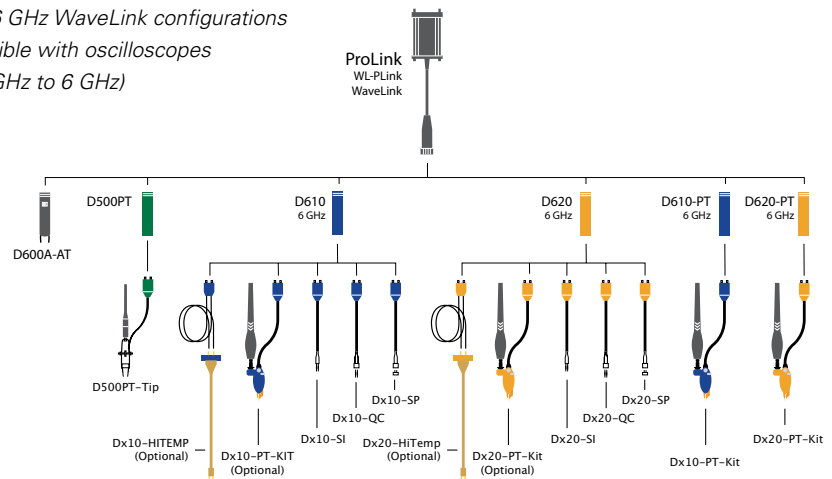

*≤ 4 GHz WaveLink configurations  
(compatible with oscilloscopes  
up to and including 4 GHz)*

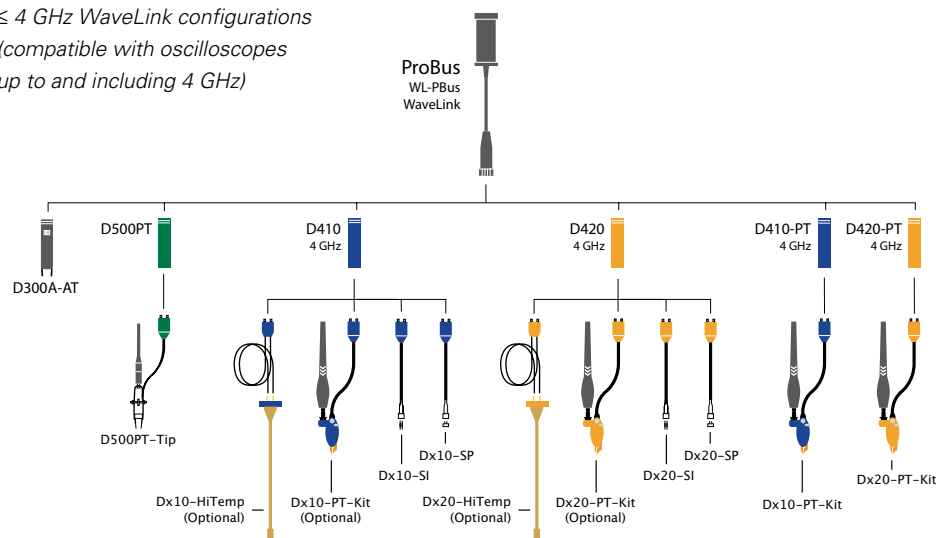



# WAVELINK LOW BANDWIDTH DIFFERENTIAL PROBES

Specifications	D610	D620	D410	D420	D600A-AT	D300A-AT	D500PT
Bandwidth, System DC to -3 dB							
PT Positioner Lead	6 GHz <sup>1</sup>		4 GHz <sup>1</sup>		6 GHz	3 GHz	5 GHz
SI Solder-In Lead	6 GHz <sup>1</sup>		4 GHz <sup>1</sup>			N/A	
QC Interconnect Lead	4 GHz				N/A		
SP Interconnect Lead		3 GHz				N/A	
HiTemp Solder-In Lead	6 GHz		4 GHz		N/A	N/A	N/A
Rise Time (10–90)							
PT Positioner Lead	< 75 ps		< 112 ps		< 75 ps <sup>1</sup>	< 130 ps <sup>1</sup>	< 90 ps <sup>1</sup>
SI Solder-In Lead	< 75 ps		< 112 ps			N/A	
QC Interconnect Lead	< 122.5 ps				N/A		
SP Interconnect Lead		< 150 ps				N/A	
HiTemp Solder-In Lead	< 75 ps		< 112 ps		N/A	N/A	N/A
LF Attenuation Accuracy <sup>1</sup>	2% < 1.25 V <sub>pp</sub> 5% 1.25 V <sub>pp</sub> to 2.5 V <sub>pp</sub>	2% < 2.25 V <sub>pp</sub> 5% 2.5 V <sub>pp</sub> to 5 V <sub>pp</sub>	2% < 1.25 V <sub>pp</sub> 5% 1.25 V <sub>pp</sub> to 2.5 V <sub>pp</sub>	2% < 2.25 V <sub>pp</sub> 5% 2.5 V <sub>pp</sub> to 5 V <sub>pp</sub>	2% 0±1.2 V (with 0 V common mode) 5% ±1.2 V ±2.4 V (with 0 V common mode)		
Zero Offset (within 15 minutes after autozero)	< 2.5 mV <sup>1</sup>	< 5 mV <sup>1</sup>	< 2.5 mV <sup>1</sup>	< 5 mV <sup>1</sup>		< 10 mV <sup>1</sup>	
Offset Gain Accuracy	1% of offset value <sup>1</sup>					N/A	
Input Differential Range	2.5 V <sub>pp</sub>	5 V <sub>pp</sub>	2.5 V <sub>pp</sub>	5 V <sub>pp</sub>		4.8 V <sub>pp</sub>	
Differential Offset Range	±3 V					0 V	
Common Mode Range (max. peak voltage either input to ground)	±4 V					±2.4 V	
DC Input Resistance	100 kΩ differential 50 kΩ single-ended					4 kΩ differential 2 kΩ single-ended	
AC Loading (differential Z <sub>in</sub> )	200 Ω	200 Ω	200 Ω	200 Ω	120 Ω	600 Ω	200 Ω
CMRR	> 30 dB@10 MHz > 26 dB@6 GHz		> 30 dB@10 MHz > 26 dB@3.5 GHz		> 40 dB@1 MHz > 30 dB@3 GHz > 20 dB@6 GHz (D600A-AT only)		> 25 dB@1 GHz > 19 dB@3 GHz > 16 dB@5 GHz
Differential Input Capacitance@1 GHz							
SI Solder-In Lead	210 fF	120 fF	210 fF	120 fF		N/A	
PT Positioner Lead	290 fF	290 fF	290 fF	290 fF		170 fF	
QC Interconnect Lead	550 fF	530 fF	550 fF	530 fF		N/A	
SP Interconnect Lead	980 fF	980 fF	980 fF	980 fF		N/A	
HiTemp Solder-In Lead	210 fF	120 fF	210 fF	120 fF		N/A	
Noise (System referred to probe input)	2.8 mV <sub>rms</sub>	4.8 mV <sub>rms</sub>	2.3 mV <sub>rms</sub>	4.3 mV <sub>rms</sub>	5.8 mV <sub>rms</sub>	5.0 mV <sub>rms</sub>	5.8 mV <sub>rms</sub>

<sup>1</sup> Warranted specification.

## Ordering Information

Product Description	Product Code	Product Description	Product Code
<b>Probe Tip Modules</b>			
WaveLink 6 GHz 2.5 V <sub>pp</sub> Differential Amplifier Small Tip Module	D610*	Differential Positioner Tip with Accessories (for use with D610 or D410)	Dx10-PT-Kit
WaveLink 4 GHz 2.5 V <sub>pp</sub> Differential Amplifier Small Tip Module	D410*	Differential Positioner Tip with Accessories (for use with D620 or D420)	Dx20-PT-Kit
WaveLink 6 GHz 5 V <sub>pp</sub> Differential Amplifier Small Tip Module	D620*	WaveLink Temperature Extension Cables for Dx10. Includes (1) Set of Matched 30" High Temperature Cables, (1) Solder-In Lead Set	Dx10-HiTemp
WaveLink 4 GHz 5 V <sub>pp</sub> Differential Amplifier Small Tip Module	D420*	WaveLink Temperature extension cables for Dx20. Includes (1) Set of Matched 30" High Temperature Cables, (1) Solder-In Lead Set	Dx20-HiTemp
WaveLink 6 GHz Differential Amplifier Module with Adjustable Tip	D600A-AT*		
WaveLink 3 GHz Differential Amplifier Module with Adjustable Tip	D300A-AT*		
WaveLink 5 GHz Differential Amplifier Module with Positioner Tip	D500PT*		
WaveLink 6 GHz, 2.5 V <sub>pp</sub> Differential Positioner Tip	D610-PT*		
WaveLink 6 GHz, 5 V <sub>pp</sub> Differential Positioner Tip	D620-PT*		
WaveLink 4 GHz, 2.5 V <sub>pp</sub> Differential Positioner Tip	D410-PT*		
WaveLink 4 GHz, 5 V <sub>pp</sub> Differential Positioner Tip	D420-PT*		
<b>Service Options</b>			
* For a complete probe, order a WL-PLink, or WL-PBus Platform/Cable Assembly with the probe tip module.		NIST Traceable Calibration with Test Data <sup>†</sup> (one module)	D600A-AT-CCNIST D300A-AT-CCNIST D500PT-CCNIST
		<sup>†</sup> CCNIST NIST traceable calibration with test data is an available option for D610, D620, D410, D420, D500PT, D600A-AT, or D300A-AT only when ordered with either a WL-PLink or WL-PBus.	D610-CCNIST D620-CCNIST D410-CCNIST D420-CCNIST
<b>Probe Bodies</b>			
WaveLink ProLink Platform/Cable Assembly (4 – 6 GHz)	WL-PLink		
WaveLink ProBus Platform/Cable Assembly (4 GHz)	WL-PBus		

# WAVELINK MEDIUM BANDWIDTH DIFFERENTIAL PROBES



LeCroy WaveLink  
Medium Bandwidth Differential  
Probe and Accessory  
Model Numbers:

**D830**

**D1030**

**D1330**

**Dxx30-PT-KIT**

**Dxx30-SMA-SMP-LEADS**

**WL-PLINK-CASE**

## General Purpose Probe with Range of Capabilities

LeCroy's WaveLink 8-13 GHz Differential Probes are a medium bandwidth, general purpose probing solution with high input dynamic range and offset range capability. These probes support solder-in, positioner (browser), square pin and SMA/SMP cabled tip/lead connections. The range of capabilities is ideal for a variety of high speed DDR signals where high dynamic range and large offset requirements are common.

## Features and Benefits

- Choice of 8, 10, or 13 GHz bandwidth models
- 3.5 Vpk-pk dynamic range
- $\pm 4$  V offset range
- Ideal for DDR3, DDR4, LPDDR3
- Deluxe soft carrying case
- Wide variety of tips and leads
  - Solder-In Lead
  - Positioner (Browser) Tip
  - SMA/SMP Lead
  - Square Pin Lead
- SMA/SMP lead set accessory does not require purchase of a different amplifier
- Deluxe Soft Carrying Case

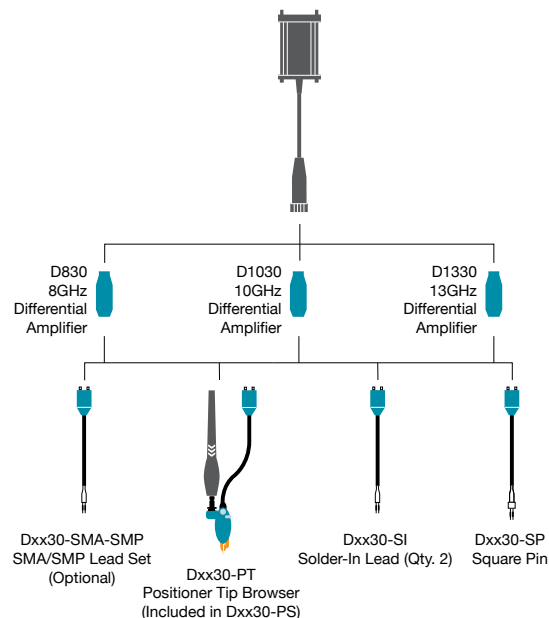

# WAVELINK MEDIUM BANDWIDTH DIFFERENTIAL PROBES

## Specifications

	D830, D830-PS	D1030, D1030-PS	D1330, D1330-PS
<b>Bandwidth</b>	<b>Dxx30-SI, Dxx30-SMA-SMP, and Dxx30-PT Tips</b> 8 GHz (probe only, guaranteed) 8 GHz (system bandwidth, when used with 808Zi/Zi-A, typical)  <b>Dxx30-SP Tip</b> 3 GHz (probe only, guaranteed) 3 GHz (system bandwidth, when used with 808Zi/Zi-A, typical)	<b>Dxx30-SI, Dxx30-SMA-SMP, and Dxx30-PT Tips</b> 10 GHz (probe only, guaranteed) 10 GHz (system bandwidth, when used with 813Zi/Zi-A, typical)  <b>Dxx30-SP Tip</b> 3 GHz (probe only, guaranteed) 3 GHz (system bandwidth, when used with 813Zi/Zi-A, typical)	<b>Dxx30-SI and Dxx30-SMA-SMP Tips</b> 13 GHz (probe only, guaranteed) 13 GHz (system bandwidth, when used with 813Zi/Zi-A, typical)  <b>Dxx30-PT Tip</b> 10 GHz (probe only, guaranteed) 10 GHz (system bandwidth, when used with 813Zi/Zi-A, typical)  <b>Dxx30-SP Tip</b> 3 GHz (probe only, guaranteed) 3 GHz (system bandwidth, when used with 813Zi/Zi-A, typical)
<b>Rise Time (10–90%)</b>	<b>Dxx30-SI, Dxx30-SMA-SMP, and Dxx30-PT Tips</b> 50 ps (typical) System rise time measured with ≥8 GHz oscilloscope  <b>Dxx30-SP Tip</b> 132 ps (typical) System rise time measured with ≥8 GHz oscilloscope	<b>Dxx30-SI, Dxx30-SMA-SMP, and Dxx30-PT Tips</b> 40 ps (typical) System rise time measured with ≥13 GHz oscilloscope  <b>Dxx30-SP Tip</b> 132 ps (typical) System rise time measured with ≥13 GHz oscilloscope	<b>Dxx30-SI and Dxx30-SMA-SMP Tips</b> 35 ps (typical) System rise time measured with ≥13 GHz oscilloscope  <b>Dxx30-PT Tip</b> 40 ps (typical) System rise time measured with ≥13 GHz oscilloscope  <b>Dxx30-SP Tip</b> 132 ps (typical) System rise time measured with ≥13 GHz oscilloscope
<b>Rise Time (20–80%)</b>	<b>Dxx30-SI, Dxx30-SMA-SMP, and Dxx30-PT Tips</b> 37.5 ps (typical) System rise time measured with ≥8 GHz oscilloscope  <b>Dxx30-SP Tip</b> 100 ps (typical) System rise time measured with ≥8 GHz oscilloscope	<b>Dxx30-SI, Dxx30-SMA-SMP, and Dxx30-PT Tips</b> 30 ps (typical) System rise time measured with ≥13 GHz oscilloscope  <b>Dxx30-SP Tip</b> 100 ps (typical) System rise time measured with ≥13 GHz oscilloscope	<b>Dxx30-SI and Dxx30-SMA-SMP Tips</b> 26 ps (typical) System rise time measured with ≥13 GHz oscilloscope  <b>Dxx30-PT Tip</b> 30 ps (typical) System rise time measured with ≥13 GHz oscilloscope  <b>Dxx30-SP Tip</b> 100 ps (typical) System rise time measured with ≥13 GHz oscilloscope
<b>Noise (Probe)</b>	<48 nV/√Hz (4.3 mVrms) (typical) Referred to input, 8 GHz bandwidth.	<48 nV/√Hz (4.8 mVrms) (typical) Referred to input, 10 GHz bandwidth.	<48 nV/√Hz (5.5 mVrms) (typical) Referred to input, 13 GHz bandwidth.
<b>Noise (System)</b>	<52 nV/√Hz (4.6 mVrms) (typical) Referred to input, 8 GHz bandwidth.	<52 nV/√Hz (5.2 mVrms) (typical) Referred to input, 10 GHz bandwidth.	<52 nV/√Hz (5.9 mVrms) (typical) Referred to input, 13 GHz bandwidth.

## Input

<b>Input Dynamic Range</b>	3.5Vpk-pk, ±1.75V (nominal)
<b>Input Common Mode Voltage Range</b>	±5 V (nominal)
<b>Input Offset Voltage Range</b>	±4 V Differential (nominal)
<b>Non-destructive Input Range</b>	±15 V (nominal)
<b>Attenuation</b>	3.75x (nominal)
<b>DC Input Resistance (nominal)</b>	200 kΩ Differential, 50 kΩ Common mode
<b>Impedance (Zmin, typical)</b>	>250 Ω Differential through entire frequency range using SI tip

## Product Description

### Complete Probe Systems

Product Description	Product Code
8 GHz Complete Probe System with Dxx30-SI Solder-In Tip (Qty. 2), Dxx30-SP Square Pin (Qty. 1), and Dxx30-PT-KIT Positioner Tip Browser (Qty. 1)	D830-PS
10 GHz Complete Probe System with Dxx30-SI Solder-In Tip (Qty. 2), Dxx30-SP Square Pin (Qty. 1), and Dxx30-PT-KIT Positioner Tip Browser (Qty. 1)	D1030-PS
13 GHz Complete Probe System with Dxx30-SI Solder-In Tip (Qty. 2), Dxx30-SP Square Pin (Qty. 1), and Dxx30-PT-KIT Positioner Tip Browser (Qty. 1)	D1330-PS

### Amplifier and Probe Tip Modules

WaveLink D830 8 GHz/3.5V <sub>p-p</sub> Differential Probe Amplifier with Dxx30-SI Solder-In Tip (Qty. 2) and Dxx30-SP Square Pin (Qty. 1)	D830
WaveLink D1030 10 GHz/3.5V <sub>p-p</sub> Differential Probe Amplifier with Dxx30-SI Solder-In Tip (Qty. 2) and Dxx30-SP Square Pin (Qty. 1)	D1030
WaveLink D1330 13 GHz/3.5V <sub>p-p</sub> Differential Probe Amplifier with Dxx30-SI Solder-In Tip (Qty. 2) and Dxx30-SP Square Pin (Qty. 1)	D1330

### Positioner Tip (Browser) Kits

WaveLink Dxx30-PT (up to 10 GHz rating) Adjustable Positioner Tip Kit. For use with Dxx30 amplifiers.	Dxx30-PT-KIT
---	--------------

### Probe Platform/Cable Assemblies and Adapters

WaveLink ProLink Platform/Cable Assembly Kit with complete soft carrying case for all probe items.	WL-PLink-CASE
--	---------------

## Product Description

### SMA/SMP Lead Set

Lead set for use with Dxx30 amplifiers.	Dxx30-SMA-SMP-LEADS
---	---------------------

### Accessories

Cascade Microtech EZ-Probe Positioner	EZ PROBE
Probe Deskew and Calibration Test Fixture	TF-DSQ

### Calibration Options

NIST Calibration for D830. Includes test data.	D830-CCNIST
NIST Calibration for D1030. Includes test data.	D1030-CCNIST
NIST Calibration for D1330. Includes test data.	D1330-CCNIST

### Replacement Parts

Replacement Dxx30-SI 8-13 GHz Solder-In Lead with Qty. 5 Spare Resistors.	Dxx30-SI
Replacement SI Resistor Kit for Dxx05-SI and Dxx30-SI Solder-In Tip - Kit of 5	Dxx05-SI-RESISTORS
Quantity 4 Replacement Pogo Pin Tips and Qty. 2 Replacement Sockets for Dx10-PT, Dx20-PT, and Dxx30-PT Adjustable Positioner Tips.	Dxx0-PT-TIPS
Replacement Probe Tip Holder Kit	PK600ST-3
Replacement Platform/Cable Assembly Mounting Kit	PK600ST-4
Quantity 1 Package of Black Adhesive Pads (10/pkg) and Quantity 1 Package of White Adhesive Pads (10/pkg)	Dxx0-PT-TAPE
Quantity 1 Package of Adhesive Probe Connection Guides (200 individual guides/package)	Dxx05-PT-GUIDES

# WAVELINK HIGH BANDWIDTH DIFFERENTIAL PROBES



LeCroy WaveLink  
High Bandwidth Differential  
Probe and Accessory  
Model Numbers:

**D1305-A**  
**D1605-A**  
**D2005-A**  
**D2505-A**  
**LPA-2.92**  
**WL-2.92MM**  
**WL-PLINK-A**

## Ultra-wideband Architecture for Superior Signal Fidelity

LeCroy's WaveLink® high bandwidth differential probes utilize advanced differential traveling wave (distributed) amplifier architecture to achieve superior high frequency true analog broadband performance. Traveling wave (distributed) amplifiers are commonly used in ultra high frequency broadband amplifiers. This multi-stage amplifier architecture maximizes gain per stage and minimizes probe attenuation, which provides very low probe noise and fast rise times.

## Features & Benefits

- Up to 25 GHz bandwidth (probe + oscilloscope)
- System rise time as fast as 13 ps (20–80%)
- Highest bandwidth Solder-In solution (25 GHz)
- Ultra-compact browsertip (22 GHz)
- Superior probe impedance minimizes AC loading on device under test (DUT)
- Carbon-composite browser tips optimize signal fidelity and loading
- Probe noise as low as 14 nV/ $\sqrt{\text{Hz}}$  (1.6 Vrms)
- Low probe attenuation
- Large operating voltage range  
±4 V common mode range  
±2.5 V offset range  
2.0 V<sub>pk-pk</sub> dynamic range
- Long length Solder-In tip with field replaceable resistors

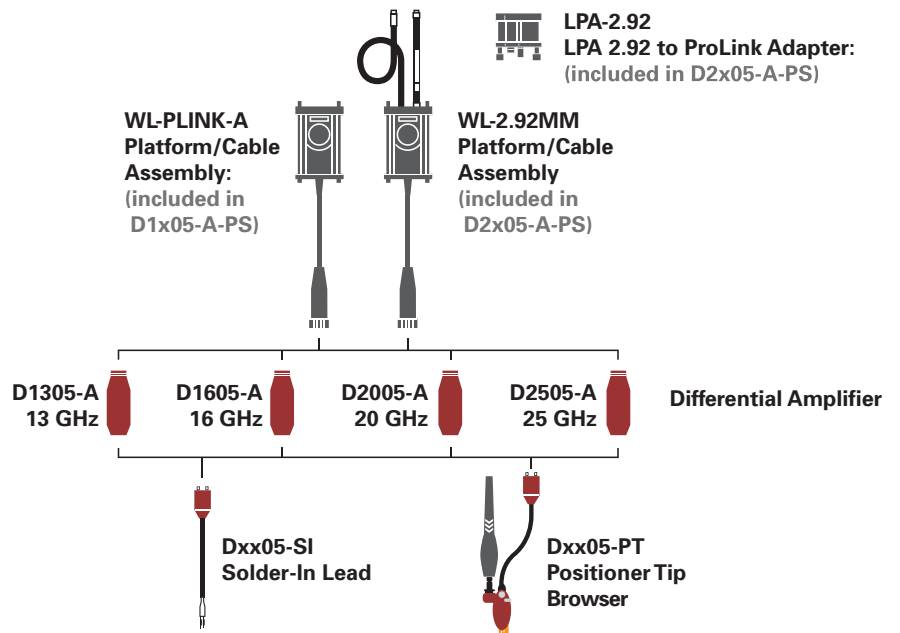

# WAVELINK HIGH BANDWIDTH DIFFERENTIAL PROBES

Specifications	D1305-A, D1305-A-PS	D1605-A, D1605-A-PS	D2005-A, D2005-A-PS	D2505-A, D2505-A-PS
<b>Bandwidth</b>	<b>Dxx05-SI and Dxx05-PT Tips</b> 13 GHz (probe only, guaranteed) 13 GHz (system bandwidth, when used with 813Zi, typical)	<b>Dxx05-SI and Dxx05-PT Tips</b> 16 GHz (probe only, guaranteed) 16 GHz (system bandwidth, when used with 816Zi, typical)	<b>Dxx05-SI and Dxx05-PT Tips</b> 20 GHz (probe only, guaranteed) 20 GHz (system bandwidth, when used with 820Zi, typical)	<b>Dxx05-SI Lead</b> 25 GHz (probe only, guaranteed) 25 GHz (system bandwidth, when used with 825Zi, typical) <b>Dxx05-PT Tip</b> 22 GHz (system bandwidth, when used with 825Zi, typical) 20 GHz (probe only, guaranteed)
<b>Rise Time (10–90%)</b>	<b>Dxx05-SI and Dxx05-PT Tips</b> 32.5 ps (typical) System rise time measured with $\geq 13$ GHz oscilloscope	<b>Dxx05-SI and Dxx05-PT Tips</b> 28 ps (typical) System rise time, measured with $\geq 16$ GHz oscilloscope	<b>Dxx05-SI and Dxx05-PT Tips</b> 20 ps (typical) System rise time measured with $\geq 20$ GHz oscilloscope	<b>Dxx05-SI Lead</b> 17.5 ps (typical) System rise time measured with $\geq 25$ GHz oscilloscope <b>Dxx05-PT Tip</b> 19 ps (typical) System rise time measured with $\geq 25$ GHz oscilloscope
<b>Rise Time (20–80%)</b>	<b>Dxx05-SI and Dxx05-PT Tips</b> 24.5 ps (typical) System rise time measured with $\geq 13$ GHz oscilloscope	<b>Dxx05-SI and Dxx05-PT Tips</b> 21 ps (typical) System rise time measured with $\geq 16$ GHz oscilloscope	<b>Dxx05-SI and Dxx05-PT Tips</b> 15 ps (typical) System rise time measured with $\geq 20$ GHz oscilloscope	<b>Dxx05-SI Lead</b> 13 ps (typical) System rise time measured with $\geq 25$ GHz oscilloscope <b>Dxx05-PT Tip</b> 14 ps (typical) System rise time measured with $\geq 25$ GHz oscilloscope
<b>Noise (Probe)</b>	$< 14$ nV/ $\sqrt{\text{Hz}}$ (1.6 mV <sub>rms</sub> ) (typical) Referred to input, 13 GHz bandwidth	$< 14$ nV/ $\sqrt{\text{Hz}}$ (1.8 mV <sub>rms</sub> ) (typical) Referred to input, 16 GHz bandwidth	$< 18$ nV/ $\sqrt{\text{Hz}}$ (2.5 mV <sub>rms</sub> ) (typical) Referred to input, 20 GHz bandwidth	$< 18$ nV/ $\sqrt{\text{Hz}}$ (2.8 mV <sub>rms</sub> ) (typical) Referred to input, 25 GHz bandwidth
<b>Noise (System)</b>	$< 23$ nV/ $\sqrt{\text{Hz}}$ (2.7 mV <sub>rms</sub> ) (typical) Referred to input, 13 GHz bandwidth	$< 23$ nV/ $\sqrt{\text{Hz}}$ (2.9 mV <sub>rms</sub> ) (typical) Referred to input, 16 GHz bandwidth	$< 28$ nV/ $\sqrt{\text{Hz}}$ (4.0 mV <sub>rms</sub> ) (typical) Referred to input, 20 GHz bandwidth	$< 28$ nV/ $\sqrt{\text{Hz}}$ (4.5 mV <sub>rms</sub> ) (typical) Referred to input, 25 GHz bandwidth

Input	
<b>Input Dynamic Range</b>	2.0 V <sub>pk-pk</sub> , $\pm 1$ V (nominal)
<b>Input Common Mode Voltage Range</b>	$\pm 4$ V (nominal)
<b>Input Offset Voltage Range</b>	$\pm 2.5$ V Differential (nominal)
<b>Non-destructive Input Range</b>	$\pm 10$ V (nominal)
<b>Attenuation</b>	3.5x (nominal) 4.5x (nominal)
<b>DC Input Resistance (nominal)</b>	1.1 k $\Omega$ Differential 100 k $\Omega$ Common mode

## Product Description Product Code

### Complete Probe Systems

13 GHz Complete Probe System with Solder-In Tip (13 GHz) and Positioner Tip Browser (13 GHz)	D1305-A-PS
16 GHz Complete Probe System with Solder-In Tip (16 GHz) and Positioner Tip Browser (16 GHz)	D1605-A-PS
20 GHz Complete Probe System with Solder-In Tip (20 GHz) and Positioner Tip Browser (20 GHz)	D2005-A-PS
25 GHz Complete Probe System with Solder-In Tip (25 GHz) and Positioner Tip Browser (22 GHz)	D2505-A-PS

### Amplifier and Probe Tip Modules

WaveLink D1305 13 GHz/1.6 V <sub>pk-pk</sub> Differential Probe Amplifier with Dxx05-SI Solder-In Tip (Qty. 2)	D1305-A
WaveLink D1605 16 GHz/1.6 V <sub>pk-pk</sub> Differential Probe Amplifier with Dxx05-SI Solder-In Tip (Qty. 2)	D1605-A
WaveLink D2005 20 GHz/1.6 V <sub>pk-pk</sub> Differential Probe Amplifier with Dxx05-SI Solder-In Tip (Qty. 2)	D2005-A
WaveLink D2505 25 GHz/1.6 V <sub>pk-p</sub> Differential Probe Amplifier with Dxx05-SI Solder-In Tip (Qty. 2)	D2505-A

### Probe Platform/Cable Assemblies and Adapters

WaveLink ProLink Platform/Cable Assembly Kit for $\geq 13$ GHz WaveLink Probes	WL-PLINK-A
WaveLink 2.92 mm Platform/Cable Assembly Kit for $\geq 20$ GHz WaveLink Probes	WL-2.92MM
ProLink to 2.92 mm Adapter with Probe Power and Communication Pass Through	LPA-2.92

## Product Description Product Code

### Positioner Tip (Browser) Kits

WaveLink Dxx05-PT (Up to 22 GHz Rating) Adjustable Positioner Tip Kit. For use with Dxx05 Amplifiers	Dxx05-PT-KIT
--	--------------

### Accessories

Cascade Microtech EZ-Probe Positioner	EZ PROBE
Probe Deskew and Calibration Test Fixture	TF-DSQ

### Calibration Options

NIST Calibration for D1305. Includes Test Data	D1305-A-CCNIST
NIST Calibration for D1605. Includes Test Data	D1605-A-CCNIST
NIST Calibration for D2005. Includes Test Data	D2005-A-CCNIST
NIST Calibration for D2505. Includes Test Data	D2505-A-CCNIST

### Replacement Parts

Replacement Dxx05-SI 13–25 GHz Solder-In Lead with Qty. 5 Spare Resistors	Dxx05-SI
Replacement SI Resistor Kit for Dxx05-SI Solder-In Tip	Dxx05-SI-RESISTORS
Replacement Dxx05-PT Positioner Tip	Dxx05-PT
Qty. 4 Replacement Carbon Composite Pogo-pin Tips	Dxx05-PT-TIPS
Replacement Probe Tip Holder Kit	PK600ST-3
Replacement Platform/Cable Assembly Mounting Kit	PK600ST-4
Qty. 1 Package of Black Adhesive Pads (10/pkg.) and Qty. 1 Package of White Adhesive Pads (10/pkg.)	Dxx05-PT-TAPE
Qty. 1 Package of Adhesive Probe Connection Guides (200 individual guides/package)	Dxx05-PT-GUIDES

# DIFFERENTIAL PROBES

LeCroy  
Differential Probes  
Model Numbers:

**AP033**

**AP034**



**AP033**



**AP034**

## **AP033 and AP034**

High bandwidth, excellent common-mode rejection ratio (CMRR) and low noise make these active differential probes ideal for applications such as disk drive design and failure analysis, as well as wireless and data communication design. With the ProBus interface, the AP034 and AP033 become an integral part of the oscilloscope, allowing sensitivity, offset and common-mode range to be displayed on the scope screen. Common mode sensing and input protection capabilities of the AP033 add additional functionality.

## **Features for both probes:**

- 500 MHz bandwidth (AP033)
- 1 GHz bandwidth (AP034)
- x10 gain to ÷ 10 attenuation range (AP033)
- 10,000:1 DC CMRR
- Low 9 nV/ $\sqrt{\text{Hz}}$  noise (AP033)
- 1.5 pF/side input C (AP034)
- 200  $\mu\text{V}/\text{div}$  (AP033)
- Input ESD protection
- Autozero feature

# DIFFERENTIAL PROBES

## Specifications

	<b>AP034</b>	<b>AP033</b>
Bandwidth	1 GHz	500 MHz
Gain	x1 ( $\div 10$ and $\div 20$ with plug-on attenuators)	x10, x1, $\div 10$ ( $\div 100$ with plug-on $\div 10$ attenuator)
DC Accuracy	2% typical (probe only)	1% in x1 without external attenuator
Input Resistance	1 M $\Omega$    1.5 pF each input to ground 2 M $\Omega$    0.85 pF between inputs	1 M $\Omega$ each input to ground 2 M $\Omega$ differential between inputs
Differential Mode Range	$\pm 400$ mV (x1) $\pm 4$ V ( $\div 10$ ) $\pm 8$ V ( $\div 20$ )	$\pm 400$ mV (x1) $\pm 40$ mV (x10) $\pm 4$ V ( $\div 10$ ) $\pm 40$ V ( $\div 100$ )
Offset Range	$\pm 1.6$ V (x1) $\pm 16$ V ( $\pm 10$ ) $\pm 32$ V ( $\pm 20$ )	$\pm 400$ mV (x1, x10) $\pm 4$ V ( $\pm 10$ ) $\pm 40$ V ( $\pm 100$ )
Common-Mode Range	$\pm 16$ V (x1) $\pm 42$ V ( $\pm 10$ ) $\pm 42$ V ( $\pm 20$ )	$\pm 42$ V peak ( $\pm 10$ ) $\pm 4.2$ V peak ( $\pm 100$ )
CMRR	70 Hz 10,000:1 (80 dB) 1 MHz 100:1 (40 dB) 100 MHz 18.1 (25 dB) 500 MHz 9:1 (19 dB)	70 Hz 10,000:1 (80 dB) 100 kHz 10,000:1 (80 dB) 1 MHz 1000:1 (60 dB) 10 MHz 100:1 (40 dB) 250 MHz 5:1 (14 dB)

## Ordering Information

Product Description	Product Code
500 MHz Differential Probe	AP033
1 GHz Differential Probe	AP034

# HIGH VOLTAGE DIFFERENTIAL PROBES

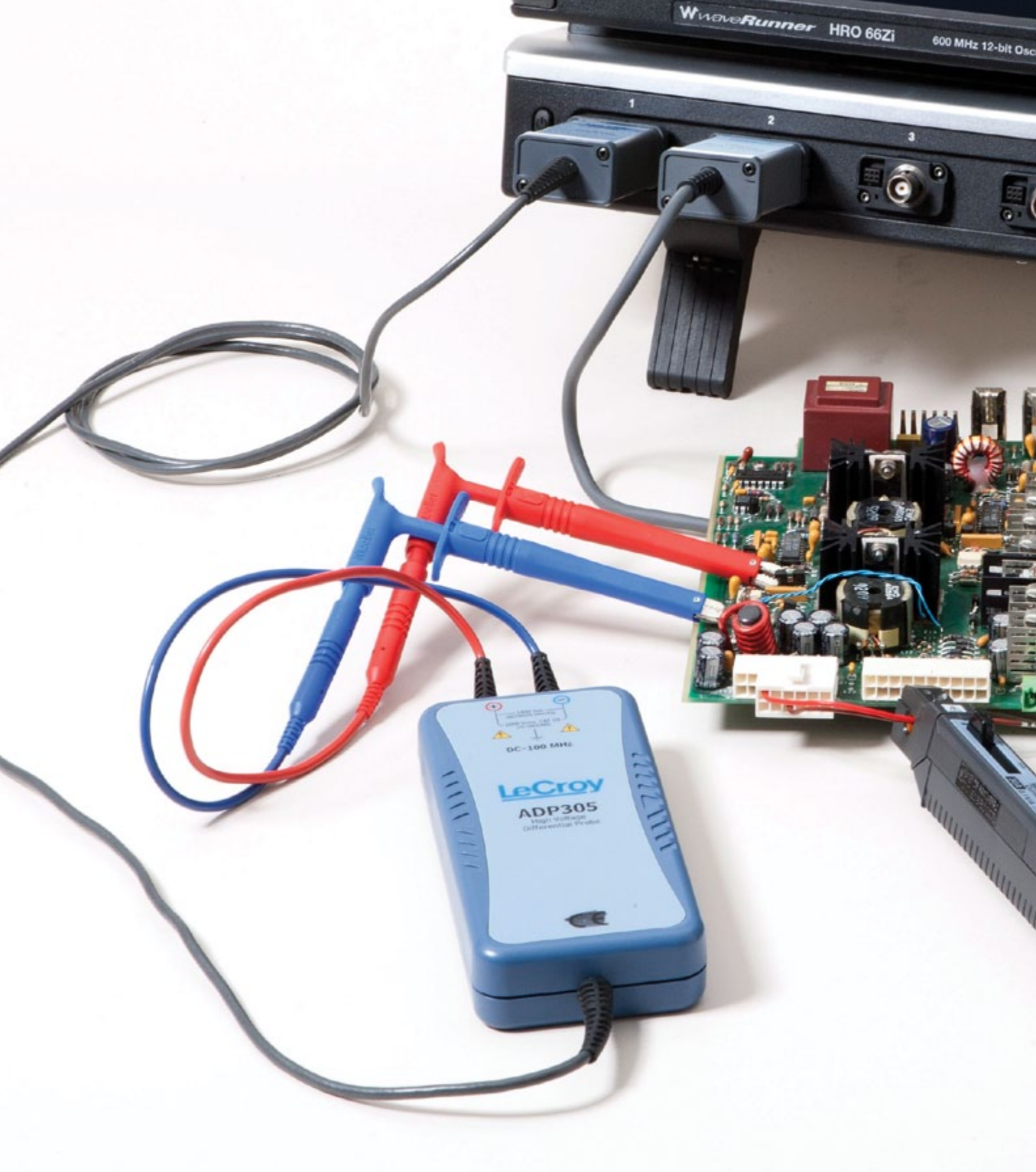



# HIGH VOLTAGE DIFFERENTIAL PROBES

**Differential active probes are like two probes in one. Instead of measuring a test point in relation to a ground point (like single-ended active probes), differential probes measure the difference in voltage of a test point in relation to another test point.**

LeCroy  
High Voltage  
Differential Probe  
Model Numbers:

**AP031**  
**ADP300**  
**ADP305**

*Opposite page:  
ADP305 High Voltage Differential Probe*

# HIGH VOLTAGE DIFFERENTIAL PROBES



LeCroy  
High Voltage  
Differential Probes  
Model Numbers:

**AP031**  
**ADP300**  
**ADP305**

The AP031 is a low cost, battery operated active differential probe intended for measuring higher voltages. The differential techniques employed permit measurements to be taken at two points in a circuit without reference to the ground, allowing the oscilloscope to be safely grounded without the use of opto-isolators or isolating transformers.

## Features

- Safe floating measurements
- 15 MHz bandwidth
- 700 V maximum input voltage
- Works with any 1 M $\Omega$  input oscilloscope

## AP031 Specifications

Attenuation	$\div 10 / \div 100$
Bandwidth	15 MHz
Input R	4 M $\Omega$
Differential Mode Range	$\pm 70 \text{ V} / \pm 700 \text{ V DC} + \text{Peak AC}$
Common Mode Range	$\pm 700 \text{ V DC} + \text{Peak AC}$
CMRR	86 dB @ 50 Hz 56 dB @ 200 kHz

Power Requirements: four AA batteries

# HIGH VOLTAGE DIFFERENTIAL PROBES

ADP30X high-voltage active probes are safe, easy-to-use, and ideally suited for measuring power electronics. The ADP300 is designed for troubleshooting low-frequency power devices and other circuits where the reference potential is elevated from the ground or the location of the ground is unknown. The ADP305 is designed for measuring the high-speed floating voltages found in today's power electronics.



## Features

- 20 MHz and 100 MHz bandwidth
- 1,000 V rms common mode voltage
- 1,400 V peak differential voltage
- EN 61010 CAT III
- 80 dB CMRR at 50/60 Hz
- ProBus system
- Full remote control

## ADP30X Specifications

### Electrical Characteristics

Bandwidth	20 MHz (ADP300)
	100 MHz (ADP305)
Differential Voltage	1,400 V peak
Common Mode Voltage	1,000 V rms CAT III
Low-Frequency Accuracy (probe only)	1% of Reading
CMRR	50/60 Hz 80 dB (10,000:1) 100 kHz 50 dB (300:1)
Max. Slew Rate (referenced to input)	60,000 V/ $\mu$ s (ADP300)
	300,000 V/ $\mu$ s (ADP305)
AC Noise (referenced to input)	50 mV rms
Attenuation	$\div 100/\div 1000$ (automatically selected by scope)
Input Impedance	Between inputs 8 M $\Omega$ , 6 pF Each input to ground 4 M $\Omega$ , 1 pF
Sensitivity	1 V/div to 350 V/div (ADP300)
	200 mV/div to 350 V/div (ADP305)
Interface	ProBus, 1 M $\Omega$ *

### General Characteristics

Overall Length	2 m
Input Connectors	4 mm Shrouded Banana Plug
Operating Temperature	0 °C to 50 °C
Warranty	1 year

\*Requires AP-1M for oscilloscopes with 50  $\Omega$  only inputs

## Ordering Information

### Product Description

Product Description	Product Code
700 V, 15 MHz Differential Probe ( $\div 10$ , $\div 100$ )	AP031
1,400 V, 100 MHz High-Voltage Differential Probe	AP305
1,400 V, 20 MHz High-Voltage Differential Probe	AP300

# DIFFERENTIAL AMPLIFIERS



# DIFFERENTIAL AMPLIFIERS

Differential amplifiers are intended to act as signal conditioning preamplifiers for oscilloscopes and network and spectrum analyzers, providing differential measurement capability to instruments having only a single-ended input. The "-PR2" version of each amplifier is a dual channel unit. The DXC series differential input cables are matched to the characteristics of the amplifier.

LeCroy  
Differential Amplifier  
and Accessory  
Model Numbers:

**DA1855A**  
**DA1855-PR2**  
**DA1855A-PR2-RM**  
**DA1855A-RM**  
**DSC5100**  
**DXC100A**  
**DXC200**  
**DA101**

*Opposite page:  
The DA1855A Differential Amplifier can be  
used for a complete PowerMeasure System.*

# DIFFERENTIAL AMPLIFIERS

LeCroy  
Differential Amplifier  
and Accessory  
Model Numbers:

**DA1855A**  
**DA1855-PR2**  
**DA1855A-PR2-RM**  
**DA1855A-RM**  
**DSC5100**  
**DXC100A**  
**DXC200**  
**DA101**



## DXC-5100

$\div 100$ , 2.5KV Passive High Voltage Probe Pair. Requires DA101 for full performance



## DXC100A

$\div 100$  or  $\div 10$  Selectable, 250 MHz Passive Differential Probe Pair

- DC to 100 MHz Bandwidth with DA1855A DC to 10 MHz Bandwidth with DA1822
- Max Input Voltage 500 V
- Selectable 10 or 100 Attenuation Factor
- 1.2 Meter Cable Length



## DXC200

$\div 1$ , 50 MHz, Passive Differential Probe Pair

- DC to 50 MHz with DA1855A DC to 10MHz with DA1822A
- Max Input Voltage 500 V (Limited to Amplifier Max Input Voltage)
- x1 Differential Probe Pair
- 0.7 Meter Cable Length



## DA101

$\div 10$ , 1MOhm Passive Attenuator for DXC series probes

# DIFFERENTIAL AMPLIFIERS



## DA1855A

The DA1855A is a stand-alone, high-performance 100 MHz differential amplifier. It is intended to act as a signal conditioning preamplifier for oscilloscopes, digitizers and spectrum analyzers, providing differential measurement capability to instruments having only a single-ended input. When used with a DA1855A, oscilloscopes can obtain Common Mode Rejection Ratio (CMRR) and overdrive recovery performance levels previously unobtainable.

Amplifier gain can be set to 1 or 10. A built-in input attenuator can be separately set to attenuate signals by a factor of 10, providing gains of 10, 1, or 0.1 and common mode dynamic range of  $\pm 15.5$  V ( $\div 1$ ) or  $\pm 155$  V ( $\div 10$ ). Optional probes increase the maximum input signal and common mode ranges in proportion to their attenuation ratio but do not exceed their maximum input voltage rating.

Effective gain of the DA1855A, including probe attenuation, amplifier gain and attenuator settings, is automatically displayed.

## DA1855A-PR2

2 Ch, 100 MHz Differential Amplifier with fast over drive recovery, calibrated offset, and selectable LP filters.

## Ordering Information

### Product Description

Product Description	Product Code
1 Ch, 100 MHz Differential Amplifier with Precision Voltage Source	DA1855A
$\div 100$ or $\div 10$ Selectable, 250 MHz Passive Differential Probe Pair	DXC100A*
$\div 1$ , 50 MHz Passive Differential Probe Pair	DXC200*
$\div 100$ , 250 MHz 2.5kv, High Voltage Probe Pair (requires DA101 for full performance)	DXC-5100*
$\div 10$ 1 M $\Omega$ Passive Attenuator for DXC Series Probes	DA101*
2 Ch, 100 MHz Differential Amplifier with Precision Voltage Source	DA1855A-PR2
DA1855A with Rackmount	DA1855A-RM
DA1855A with Rackmount (must be ordered at time of purchase, no retrofit)	DA1855A-PR2-RM

\*Must be used with DA Series Differential Amplifiers

# HIGH VOLTAGE PROBES

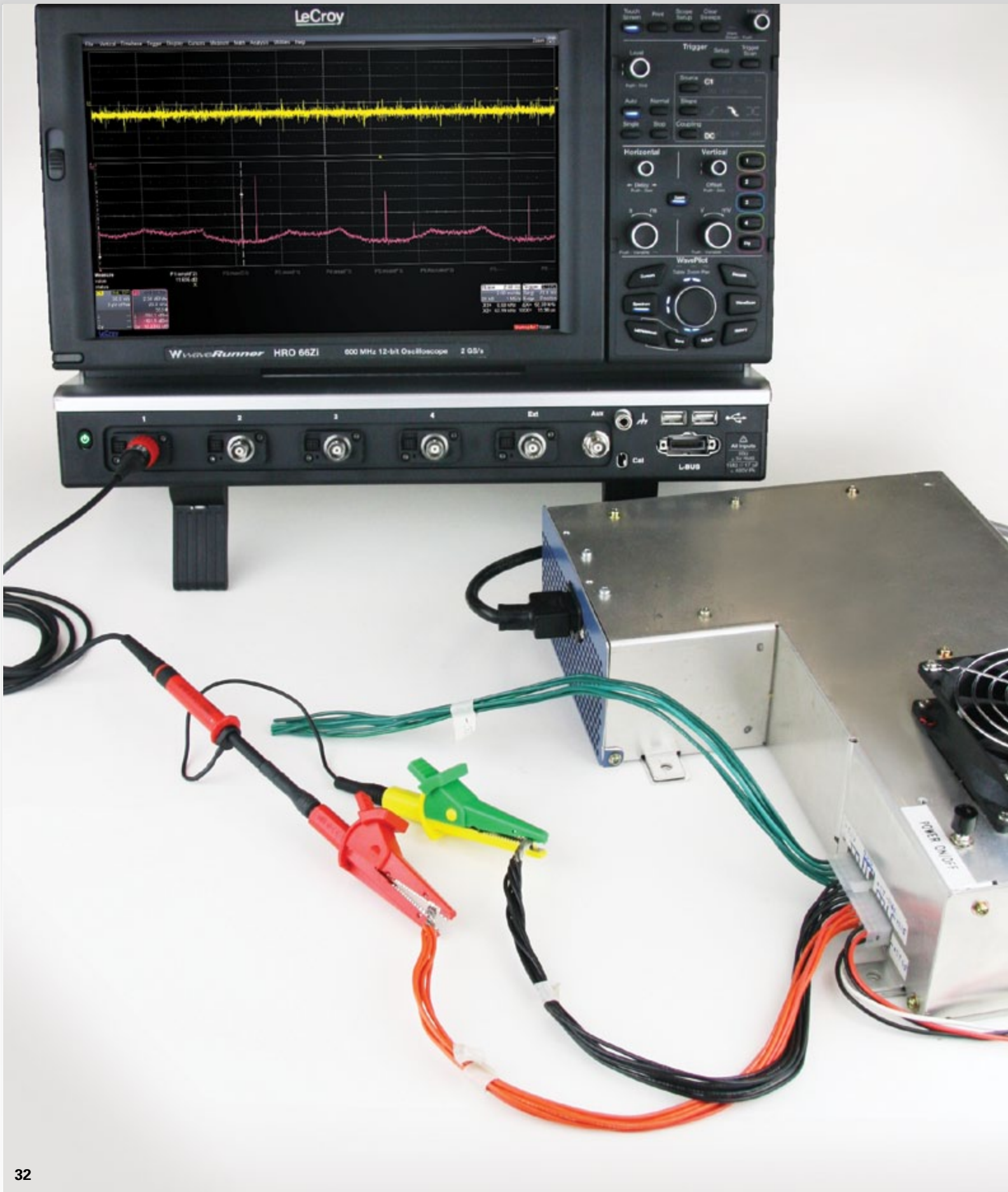



# HIGH VOLTAGE PROBES

The PPE series of probes are suitable for a wide range of applications where high-voltage measurements must be made safely and accurately. There are five fixed-attenuation probes covering a range from 2 kV to 20 kV, and one switchable probe providing  $\div 10/\div 100$  attenuation for voltage inputs up to 1.2 kV.

New technology which utilizes hybrid circuitry (and switch reading for probes with switchable gain/attenuation) minimizes ringing and overshoot to provide a precise response.

LeCroy  
High Voltage Probe  
Model Numbers:

**PPE1.2KV**

**PPE2KV**

**PPE4KV**

**PPE5KV**

**PPE6KV**

**PPE20KV**

*Opposite page:  
PPE Series High Voltage Probe*

# HIGH VOLTAGE PROBES



LeCroy  
High Voltage Probe  
Model Numbers:

- PPE1.2KV**
- PPE2KV**
- PPE4KV**
- PPE5KV**
- PPE6KV**
- PPE20KV**

The PPE series includes five fixed-attenuation probes covering a range from 2 kV to 20 kV, and one switchable probe providing  $\div 10/\div 100$  attenuation for voltage inputs up to 1.2 kV. All fixed-attenuation, standard probes automatically rescale compatible LeCroy oscilloscopes for the appropriate attenuation of the probe.

## Features

- Safe, accurate high-voltage measurement
- 1.2 kV to 20 kV

## High-Voltage Probes Selection Guide Specifications

Types	Bandwidth (MHz)	Input R ( $\Omega$ )	Input C (pF)	Attenuation	Maximum Voltage	Probe Encoding	Cable
PPE1.2kV*	400	50 M	< 6	$\div 10 / \div 100$	600 V/1.2 kV	No	2 m
PPE2kV*	400	50 M	< 6	$\div 100$	2 kV	Yes	2 m
PPE4kV*	400	50 M	< 6	$\div 100$	4 kV	Yes	2 m
PPE5kV*	400	50 M	< 6	$\div 100$	5 kV	Yes	2 m
PPE6kV*	400	50 M	< 6	$\div 1000$	6 kV	Yes	2 m
PPE20kV <sup>†</sup>	100	50 M	< 2	$\div 1000$	20 kV	Yes	3 m

(40 KV peak)

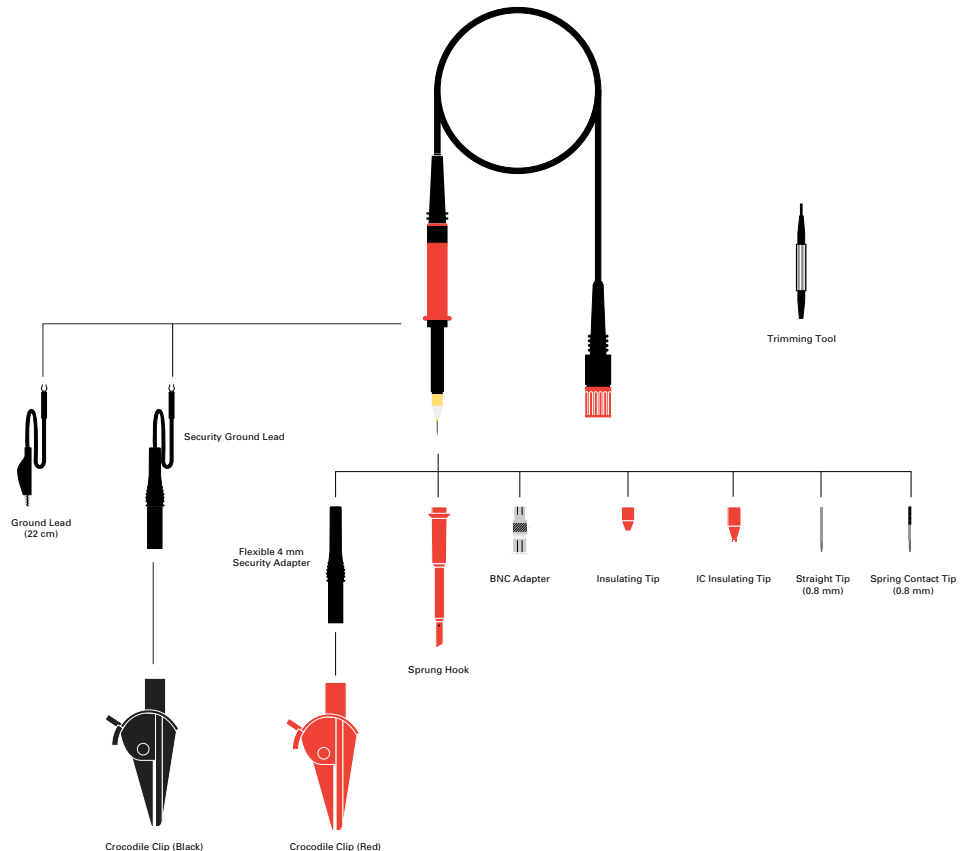

# HIGH VOLTAGE PROBES

## Ordering Information

Product Description	Product Code
÷10/÷100; 200/300 MHz; 5 MΩ/50 MΩ High-Voltage Probe 600 V/1.2 kV max. Voltage DC	PPE1.2KV
÷1000; 100 MHz; 50 MΩ High-Voltage Probe 20 kV (40 kV Peak) max. Voltage DC and Peak AC	PPE20KV
÷100; 400 MHz; 50 MΩ High-Voltage Probe 2 kV max. Voltage DC and Peak AC	PPE2KV
÷100; 400 MHz; 50 MΩ High-Voltage Probe 4 kV max. Voltage DC and Peak AC	PPE4KV
÷100; 400 MHz; 50 MΩ High-Voltage Probe 5 kV max. Voltage DC and Peak AC	PPE5KV
÷1000; 400 MHz; 50 MΩ High-Voltage Probe 6 kV max. Voltage DC and Peak AC	PPE6KV
Accessory Kit for PPE1.2kV, 2kV, 4kV, 5kV, and 6kV	PK103
Standard Probe Accessory Kit for PPE20kV	PK104
Ground Lead (15 cm)	PK104-1
Hook	PK104-2
Standard Probe Accessory Kit for PPE1.2kV, PPE2kV	PK103
Sprung Hook (red)	PK103-1
Ground Lead (22 cm)	PP005-G22
Crocodile Clip	PK30x-2
Probe Tip to BNC Adapter	PP005-BNC
IC Insulating Tip	
Screw Driver	
Probe Tip to Banana Plug Adapter	
Ground Lead with Banana Plug	
Spring Tip (0.8 mm)	PP005-ST8
Rigid Tip V2A	PP005-RT

### Standard Accessory Kit for PPE20KV

Ground Lead (15 cm)	PK104-1
Hook	PK104-2

#### Supplied with probe:

\*Probe Kit: Trimming tool, ground lead, rigid tip, IC insulator, BNC adapter, tip insulator, sprung hook, red crocodile clip.  
4 mm safety ground lead, and green/yellow crocodile clip.

† Probe Kit: trimming tool, and ground lead with a crocodile clip.

# OPTICAL PROBES

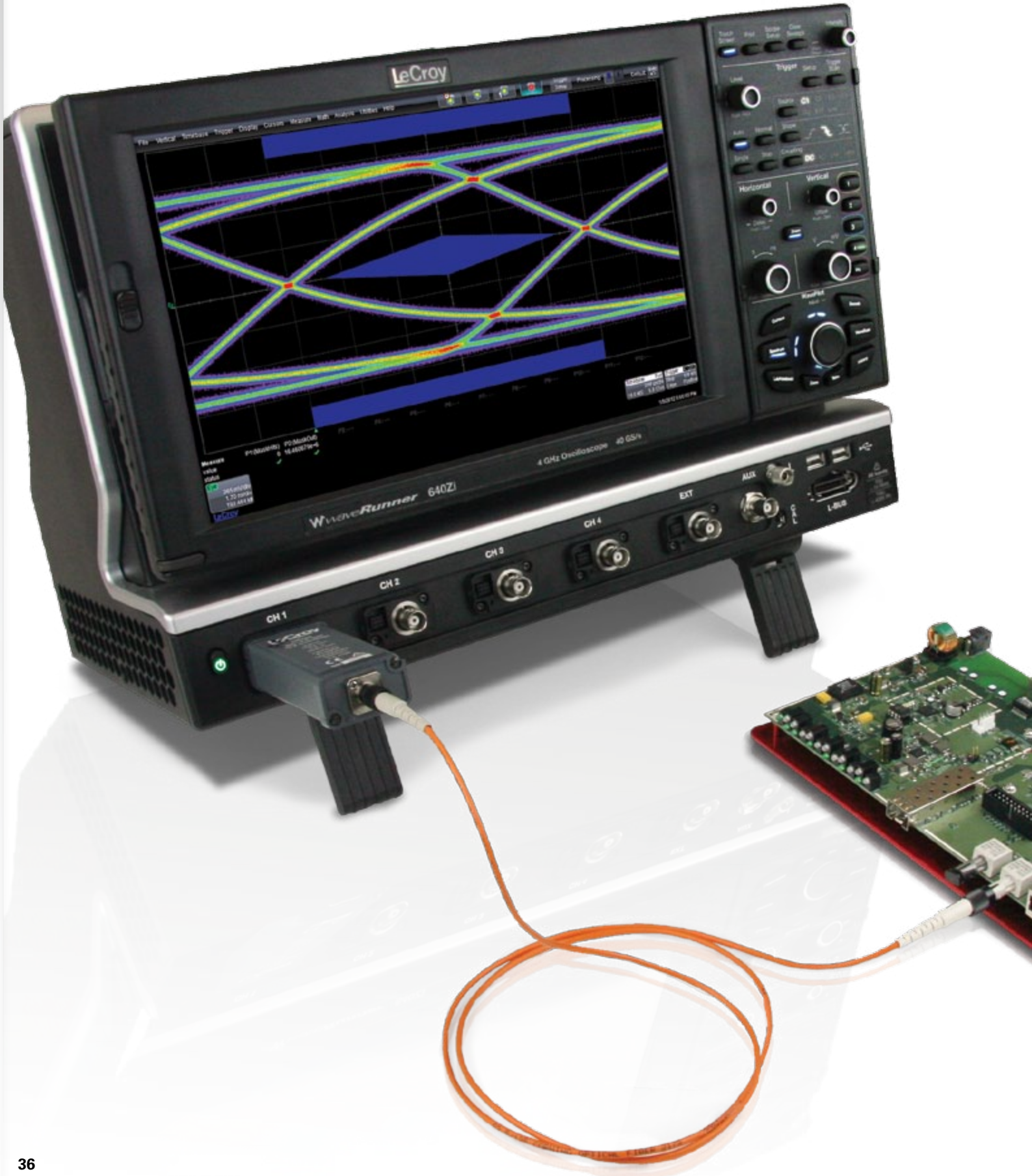

LeCroy's wide-band multi-mode optical-to-electrical converters are designed for measuring optical communications signals. Their broad wavelength range and multi-mode input optics make these devices ideal for applications including Gigabit Ethernet, Fibre Channel, and ITU telecom standards.

The OE695G is compatible with WaveMaster 8 Zi/Zi-A, LabMaster 9 Zi-A, and LabMaster 10 Zi oscilloscopes. Connection to a real-time LeCroy oscilloscope is through the 2.92mm interface, with a provided adapter to connect to ProLink interfaces.

The OE425 and OE455 are ProBus modules compatible with WaveRunner Xi/Xi-A, WaveRunner 6 Zi, WavePro 7 Zi/Zi-A oscilloscopes, as well as WaveMaster 8 Zi/Zi-A and LabMaster 9 Zi-A when used with an LPA-BNC adapter. The OE525 and OE555 are ProLink modules compatible with WavePro 7 Zi/Zi-A, WaveMaster 8 Zi/Zi-A, and LabMaster 9 Zi-A oscilloscopes.

LeCroy  
Optical Probe  
Model Numbers:

**OE695G**  
**OE425**  
**OE455**  
**OE525**  
**OE555**

*Opposite page:  
OE455 Optical Probe.*

# OPTICAL PROBES



LeCroy  
Optical Probe  
Model Numbers:

**OE695G**  
**OE425**  
**OE455**  
**OE525**  
**OE555**

## OE695G

LeCroy's OE695G wide-band optical-to-electrical converter is ideal for measuring optical datacom and telecom signals with data rates from 622 Mb/s to 12.5+ Gb/s. Connection to a real-time LeCroy oscilloscope is through the 2.92mm interface, with a provided adapter to connect to ProLink interfaces.

## Features

- Compatible with LeCroy WaveMaster 8 Zi/Zi-A, LabMaster 9 Zi-A, and LabMaster 10 Zi oscilloscopes
- Frequency range DC to 9.5 GHz (electrical, -3 dB)
- Reference receiver support from 8GFC to 10GFC FEC, or Custom (<12.5Gb/s)
- Full bandwidth mode (no reference receiver applied)
- 62.5/125  $\mu\text{m}$  multi-mode or single-mode fiber input
- +7 dBm (5 mW) max peak optical power
- Low noise (as low as 25 pW/ $\sqrt{\text{Hz}}$ )
- Ideal for Eye Mask, Extinction Ratio, and Optical Modulation Amplitude (OMA) testing

## Specifications

Optical Wavelength Range	780 to 1550 nm (calibrated range) 750 to 1650 nm (usable range)
Maximum Modulation Bandwidth	DC to 8.625 GHz (-3 dB, electrical) DC to 11.64 GHz (-3 dB, optical) (Reference Receiver Applied) DC to 9.5 GHz (-3 dB) DC to 12 GHz (-6 dB) DC to 17 GHz (-14 dB) ( $\pm 1$ dB passband variations typical, no Reference Receiver Applied)
Reference Receiver Uncertainty	$\pm 1.6$ dB up to $F_{\text{ref}} = 0.75 \times \text{bit rate}$ $\pm 4$ dB $2 \times \text{bit rate}$ setting (typical) $\pm 0.85$ dB up to $F_{\text{ref}} = 0.75 \times \text{bit rate}$ $\pm 4$ dB $2 \times \text{bit rate}$ setting (on matched oscilloscope input channel 4 with 11, 17, 20, 30, 39, 50, 75, 90, or 100 mV/div gain ranges) with purchase of OE695G-REFCAL)
Reference Receiver Settings	8GFC, OC192/STM64, 10GBASE-W, 10GBASE-R, 10GFC, ITU-T G.975 FEC, ITU-T G.709 FEC, 10GbE FEC, 10GFC FEC, Custom (622 Mb/s to 12.5 Gb/s), None (Maximum Bandwidth)
Noise Equivalent Power	25 pW/ $\sqrt{\text{Hz}}$ @ 1310 nm (typical) 50 pW/ $\sqrt{\text{Hz}}$ @ 850 nm (typical) Average noise spectral density 0-10 GHz using most sensitive vertical scale
Rise Time (10-90%)	33 ps (typical, no reference receiver applied)
Connector Type	FC/PC, compatible with 62.5/125 $\mu\text{m}$ Multi-Mode fiber, or mechanically compatible Single-Mode fiber
Maximum Optical Linear Input (1 dB compression point)	-2 dBm (typical), -3 dBm (minimum) at 1550/1310 nm +4 dBm (typical), +3 dBm (minimum) at 850 nm
Maximum Optical Power	+7 dBm (5 mW) Peak

## OE425/OE455/OE525/OE555

The O/E converters contain calibration data that can be used to create optical reference receivers for SONET/SDH (up to OC48/STM16), Fibre Channel, Gigabit Ethernet, and other optical standards. This feature is available when the O/E is used on a supported oscilloscope. The universal reference receiver supports any data rate up to 3 GHz and remains calibrated on any channel of the oscilloscope.

### Features

- Frequency range to 5 GHz (6 GHz optical)
- 62.5  $\mu\text{m}$  or narrower multi-mode or single-mode fiber input
- Broad wavelength range:
  - 500–870 nm (OE425, OE525)
  - 950–1630 nm (OE455, OE555)
- High responsivity
- Low noise
- Included Accessories:
  - Multi-mode optical fiber jumper FC-FC
  - FC to ST adapter
  - FC to SC adapter



### Specifications

	OE425/OE525	OE455/OE555
Wavelength Range	500 – 870 nm 460 – 870 nm (0.1 V/mW)	950 – 1630 nm 800 – 1630 nm (0.1 V/mW)
Conversion Gain	0.5 V/mW	1.1 V/mW
Bandwidth	5 GHz (6 GHz optical)	3.5 GHz (4.5 GHz optical)
Equivalent Noise	2.2 $\mu\text{W}$ rms	1.0 $\mu\text{W}$ rms
Maximum Optical Power (at 5% saturation)	2.2 mW	1.0 mW
Rise Time	90 ps	108 ps
Maximum Safe Input	5.5 mW	2.5 mW
Temperature Drift	0.00275 dB / $^{\circ}\text{C}$	0.00275 dB / $^{\circ}\text{C}$
Frequency Response Ripple	1.1 dB	1.1 dB
Connector Type	FC/PC	FC/PC

### Ordering Information

#### Product Description

#### Product Code

Optical-to-Electrical Converter, 785 to 1550 nm, 2.92 mm connector with ProLink adapter	OE695G
Optical-to-Electrical Converter, 500–870 nm ProBus BNC Connector	OE425
Optical-to-Electrical Converter, 950–1630 nm ProBus BNC Connector	OE455
Optical-to-Electrical Converter, 500–870 nm ProLink BMA Connector	OE525
Optical-to-Electrical Converter, 950–1630 nm ProLink BMA Connector	OE555

# PASSIVE PROBES

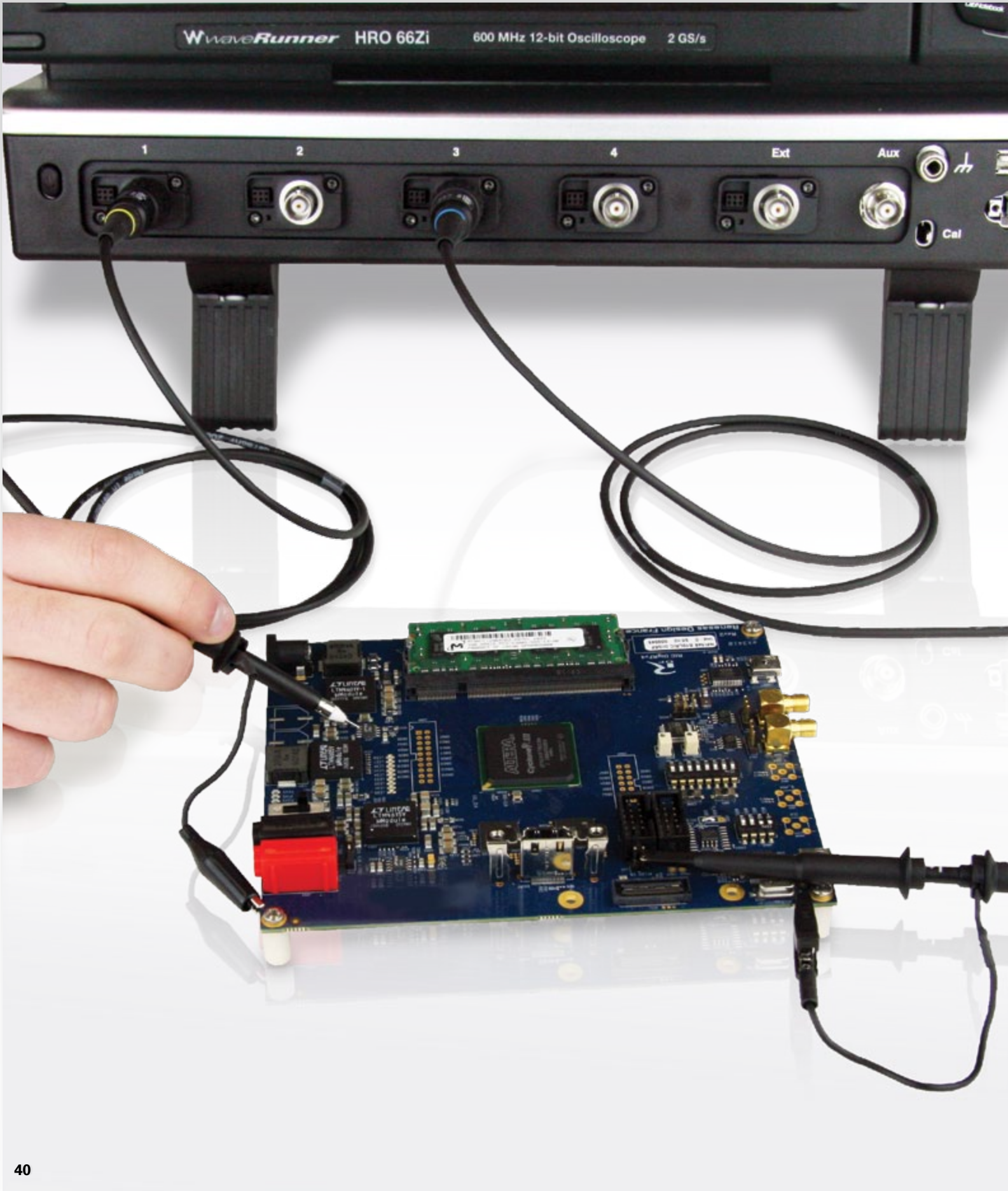



# PASSIVE PROBES

Passive probes are the standard probe provided with most oscilloscopes. Typical passive probes provide a  $\times 10$  attenuation and feature a high input resistance of 10 M $\Omega$ . This high input resistance means that passive probes are the ideal tool for low frequency signals since circuit loading at these frequencies is minimized. Passive probes are designed to handle voltages of at least 400 V, some as high as 600 V. LeCroy passive probes feature an attenuation sense pin which tells the oscilloscope to scale the waveforms automatically requiring no user input.

LeCroy  
Passive Probe  
Model Numbers:

**PP005A**  
**PP006A**  
**PP007-WR-1**  
**PP008-1**  
**PP009-1**  
**PP010-1**  
**PP011-1**  
**PP016**

# PASSIVE PROBES



LeCroy  
Passive Probe  
Model Numbers:

**PP005A**  
**PP006A**  
**PP007-WR-1**  
**PP008-1**  
**PP009-1**  
**PP010-1**  
**PP011-1**  
**PP016**

Each passive probe is recommended for a certain oscilloscope, using the right passive probe with the right oscilloscope means that the probe can be properly compensated across the entire bandwidth. Using probes with a different oscilloscope will only let you compensate for low frequencies.

## Features

- Bandwidth from 200 MHz to 500 MHz
- Probe encoding ring for automatic scale factor readout on LeCroy oscilloscopes

## Passive Probes Selection Guide Specifications

Types	Bandwidth (MHz)	Input R ( $\Omega$ )	Input C (pF)	Attenuation	Maximum Voltage	Diameter (mm)
PP005A	500	10 M	11	$\div 10$	500 V	5
PP006A	500	10 M	12	$\div 10$	600 V	5
PP007-WR-1	500	10 M	9.5	$\div 10$	400 V	2.5
PP008-1	500	10 M	9.5	$\div 10$	400 V	2.5
PP009-1	500	10 M	9.5	$\div 10$	400 V	2.5
PP010-1	500	10 M	9.5	$\div 10$	400 V	2.5
PP011-1	50	10 M	9.5	$\div 10$	400 V	5
PP016	300 MHz/ 10 MHz	10 M $\Omega$ / 1 M $\Omega$	12 pF/ 46 pF	$\div 10$ / $\div 1$	600 V	5 mm

## Ordering Information

Product Description	Product Code
$\div 10$ , 500 MHz 10 M $\Omega$ Passive Probe	PP005A
$\div 10$ , 500 MHz 10 M $\Omega$ Passive Probe	PP006A
$\div 10$ , 500 MHz 10 M $\Omega$ Passive Probe	PP007-WR-1
$\div 10$ , 500 MHz 10 M $\Omega$ Passive Probe	PP008-1
$\div 10$ , 500 MHz 10 M $\Omega$ Passive Probe	PP009-1
$\div 10$ , 200 MHz 10 M $\Omega$ Passive Probe	PP010-1
$\div 10$ , 500 MHz 10 M $\Omega$ Passive Probe	PP011-1
$\div 10$ , 300 MHz 10 M $\Omega$ Passive Probe	PP016

# PASSIVE PROBES

## Passive Probe Accessories for PP005, PP009, and PP011 Series

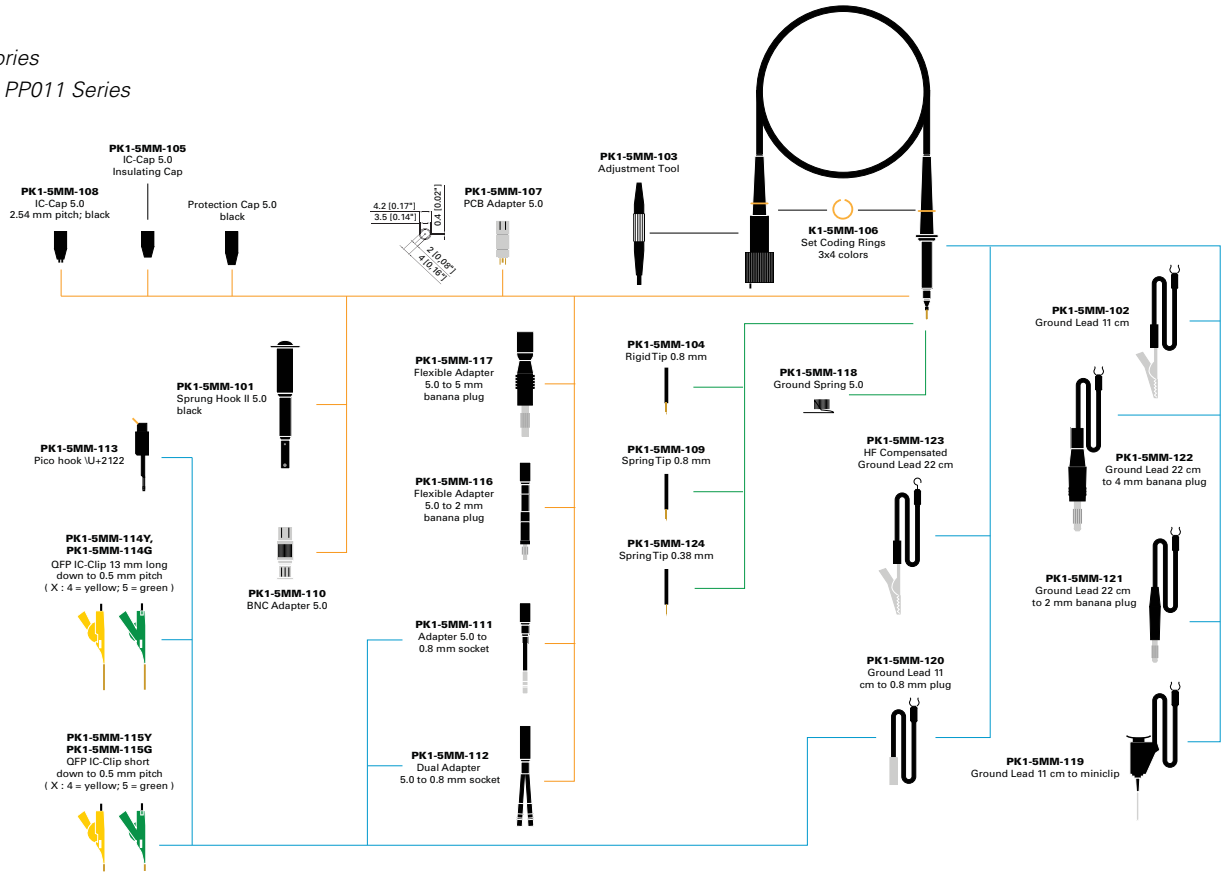

## Passive Probe Accessories for PP007 and PP008 Series

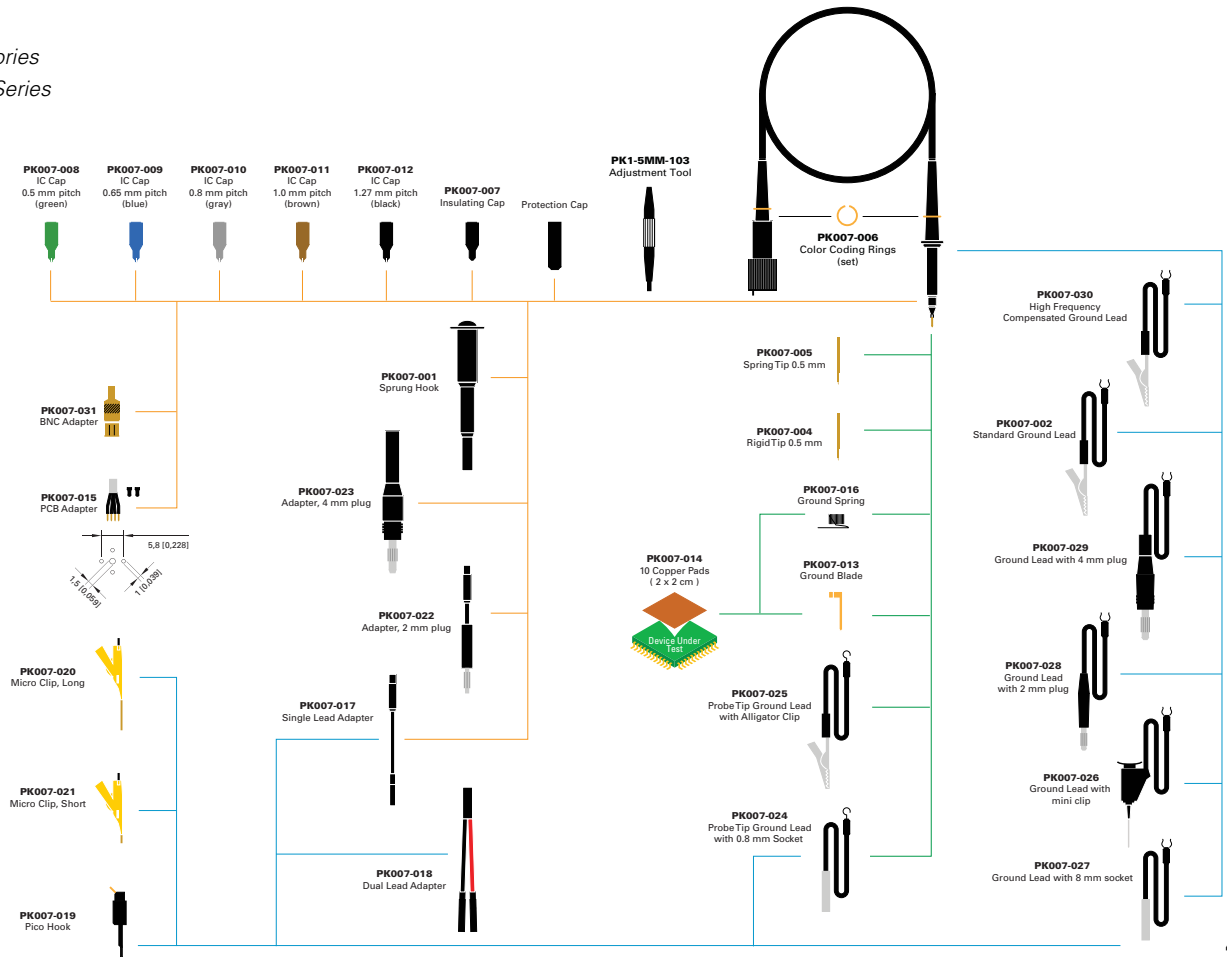

# TRANSMISSION LINE PROBES

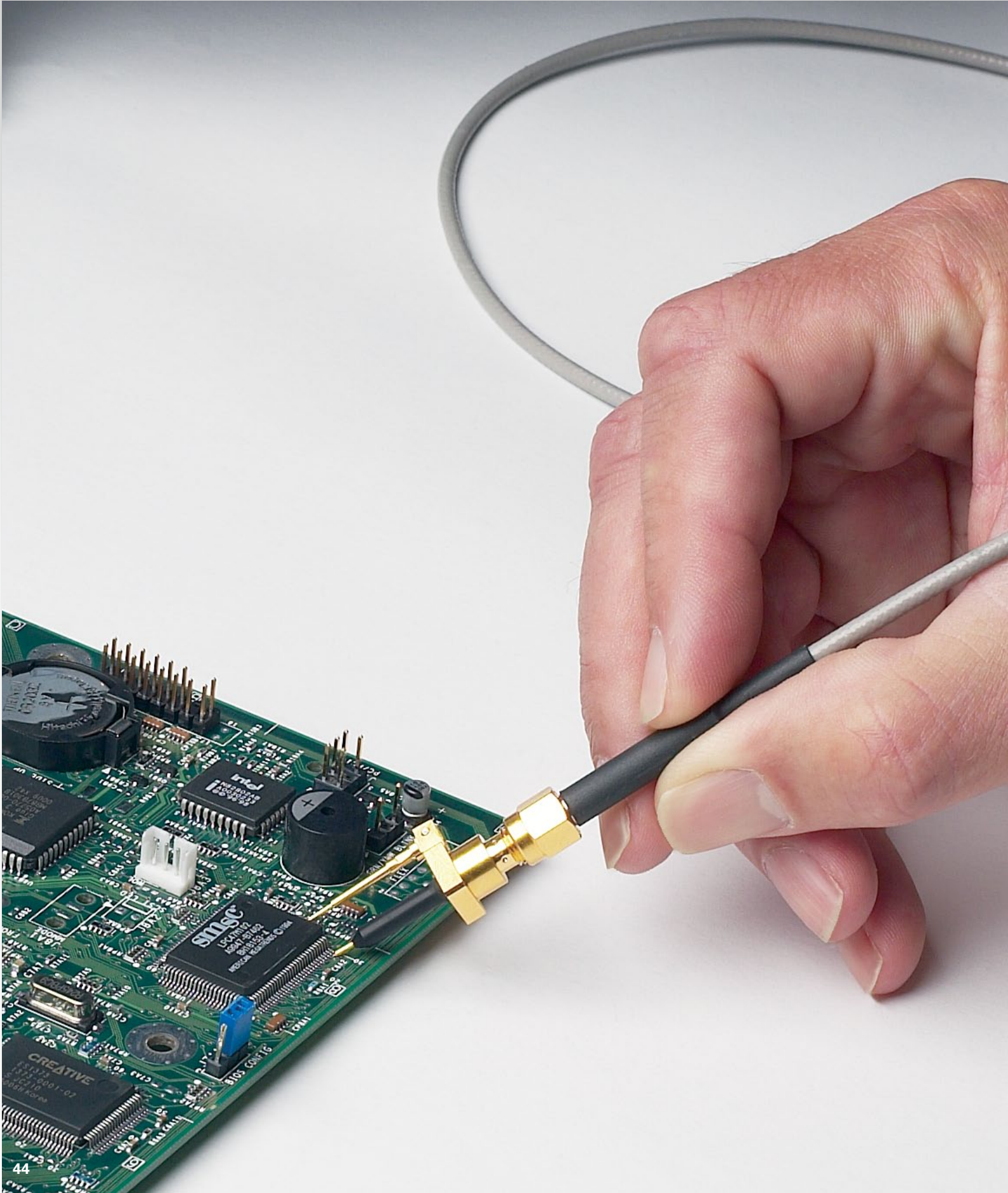

# TRANSMISSION LINE PROBES

LeCroy  
Transmission Line Probe  
Model Numbers:

**PP066**  
**PP065**

Transmission line probes are a special type of passive probe designed for use at very high frequencies. They replace the high impedance probe cable found in a traditional passive probe with a precision transmission line, with a characteristic impedance that matches the oscilloscope input ( $50\ \Omega$ ). This greatly reduces the input capacitance to a fraction of a picofarad, minimizing the loading of high frequency signals. A matching network at the tip increases the DC input resistance. While they have lower DC input resistance than a traditional passive probe (usually  $500\ \Omega$  to  $5\ \text{k}\Omega$ ), the input impedance of these probes remains nearly constant over their entire frequency range. A traditional  $\div 10$  passive probe will have a  $10\ \text{M}\Omega$  input impedance at DC, however this impedance drops rapidly with frequency, passing below the input impedance of a transmission line probe at less than 100 MHz.

In some applications, transmission line probes offer advantages over active probes. In addition to being less expensive, their passive design is more robust to over voltage and ESD exposure. They are useful in applications producing fast rising, narrow pulses with amplitudes which exceed the dynamic range of active probes. They also tend to have less parasitic effects on frequency response. A high BW transmission line probe driving a sampling oscilloscope can be used as a "golden standard" in situations when the response of an active probe measurement is questioned.

*Opposite page:  
PP066 Transmission Line Probe*

# TRANSMISSION LINE PROBES

LeCroy  
Transmission Line Probe  
Model Numbers:

**PP066**

**PP065**



## PP066

The PP066 is a high-bandwidth passive probe designed for use with the WaveMaster and other high-bandwidth oscilloscopes with 50  $\Omega$  input termination. This very low capacitance probe provides an excellent solution for higher frequency applications, especially the probing of transmission lines with 20–100  $\Omega$  impedance. The PP066 accommodates a wide range of applications, including probing of analog and digital ICs commonly found in computer, communications, data storage, and other high-speed designs.

### Features:

- Interchangeable attenuator tips
- Signal integrity at high bandwidth
- Standard SMA cable connection
- Ultra low capacitance

### PP066 Specifications

#### Electrical Characteristics

Bandwidth	DC to 7.5 GHz
Risetime	< 47 ps
Input Capacitance	< 0.20 pF
Input Resistance	500 $\Omega$ ( $\div$ 10 cartridge) 1000 $\Omega$ ( $\div$ 20 cartridge)
Maximum Voltage	15 V rms
Cable Length	1 m

#### Included with PP066

PACC-AD001  
SMA to BNC Adapter

# TRANSMISSION LINE PROBES



## PP065

The PP065 is a transmission line probe designed for use at very high frequencies. The probe's input impedance remains nearly constant over its entire frequency range. Robust to over voltage and ESD exposure, it is particularly useful in applications producing fast rising, narrow pulses with amplitudes, which exceed the dynamic range of active probes.

## Features:

- 1 GHz
- Low capacitance
- $\div 100$  1 GHz 5 k passive probe

## PP065 Specifications

Bandwidth	1 GHz
Input Capacitance	1.5 pF
Input Resistance	500 $\Omega$
Maximum Voltage	22 V
Attenuation	$\div 100$

## Ordering Information

### Product Description

7.5 GHz Low Capacitance Passive Probe  
( $\pm 10$ , 1 k $\Omega$ ;  $\pm 20$ , 500  $\Omega$ )

1 GHz Low Capacitance Passive Probe  
( $\pm 10$ , 5 k $\Omega$ )

### Product Code

PP066

PP065



1-800-5-LeCroy  
[www.lecroy.com](http://www.lecroy.com)

**Local sales offices are located throughout the world.  
Visit our website to find the most convenient location.**

© 2012 by LeCroy Corporation. All rights reserved. Specifications, prices, availability, and delivery subject to change without notice. Product or brand names are trademarks or requested trademarks of their respective holders.



Компания «Океан Электроники» предлагает заключение долгосрочных отношений при поставках импортных электронных компонентов на взаимовыгодных условиях!

Наши преимущества:

- Поставка оригинальных импортных электронных компонентов напрямую с производств Америки, Европы и Азии, а так же с крупнейших складов мира;
- Широкая линейка поставок активных и пассивных импортных электронных компонентов (более 30 млн. наименований);
- Поставка сложных, дефицитных, либо снятых с производства позиций;
- Оперативные сроки поставки под заказ (от 5 рабочих дней);
- Экспресс доставка в любую точку России;
- Помощь Конструкторского Отдела и консультации квалифицированных инженеров;
- Техническая поддержка проекта, помощь в подборе аналогов, поставка прототипов;
- Поставка электронных компонентов под контролем ВП;
- Система менеджмента качества сертифицирована по Международному стандарту ISO 9001;
- При необходимости вся продукция военного и аэрокосмического назначения проходит испытания и сертификацию в лаборатории (по согласованию с заказчиком);
- Поставка специализированных компонентов военного и аэрокосмического уровня качества (Xilinx, Altera, Analog Devices, Intersil, Interpoint, Microsemi, Actel, Aeroflex, Peregrine, VPT, Syfer, Eurofarad, Texas Instruments, MS Kennedy, Miteq, Cobham, E2V, MA-COM, Hittite, Mini-Circuits, General Dynamics и др.);

Компания «Океан Электроники» является официальным дистрибьютором и эксклюзивным представителем в России одного из крупнейших производителей разъемов военного и аэрокосмического назначения «JONHON», а так же официальным дистрибьютором и эксклюзивным представителем в России производителя высокотехнологичных и надежных решений для передачи СВЧ сигналов «FORSTAR».



## JONHON

«JONHON» (основан в 1970 г.)

Разъемы специального, военного и аэрокосмического назначения:

(Применяются в военной, авиационной, аэрокосмической, морской, железнодорожной, горно- и нефтедобывающей отраслях промышленности)

«FORSTAR» (основан в 1998 г.)

ВЧ соединители, коаксиальные кабели, кабельные сборки и микроволновые компоненты:

(Применяются в телекоммуникациях гражданского и специального назначения, в средствах связи, РЛС, а так же военной, авиационной и аэрокосмической отраслях промышленности).



Телефон: 8 (812) 309-75-97 (многоканальный)

Факс: 8 (812) 320-03-32

Электронная почта: [ocean@oceanchips.ru](mailto:ocean@oceanchips.ru)

Web: <http://oceanchips.ru/>

Адрес: 198099, г. Санкт-Петербург, ул. Калинина, д. 2, корп. 4, лит. А