

42 V System Power Supply with Ultra-low Power Window-type Watchdog Timer for Industrial Application

No. EY-409-190711

OVERVIEW

The R5115x is a system power supply IC with an ultra-low power window-type watchdog timer (VR + VD + WDT) that has an input voltage range of 3.5 V to 42 V. This is a high-reliability semiconductor device for industrial application (-Y) that has passed both the screening at high temperature and the reliability test with extended hours.

KEY BENEFITS

- Consists of a voltage regulator, a voltage detector and a watchdog timer that provides a system power supply, a power supply voltage monitoring and a system malfunction monitoring.
- Equipped with an auto monitoring stop⁽¹⁾ to cease the watchdog timer monitoring at light load.
- Outputs a reset signal from watchdog timer when a pulse signal period is too short or too long.

KEY SPECIFICATIONS

- Input Voltage Range (Absolute Maximum Rating): 3.5 V to 42.0 V (50.0 V)
- Supply Current: Typ. 8.5 μ A
- Protections: Thermal Shutdown, Output Current Limiting, Short-circuit Current Limiting

Voltage Regulator (VR) Section

- Output Voltage Range: 3.3 V to 5.0 V
- Output Voltage Accuracy: $\pm 1.6\%$ ($-40^{\circ}\text{C} \leq T_a \leq 125^{\circ}\text{C}$)
- Output Current: 250 mA

Voltage Detector (VD) Section

- Detection Voltage Threshold Range: 2.5 V to 4.8 V
- Detection Voltage Accuracy: $\pm 1.6\%$ ($-40^{\circ}\text{C} \leq T_a \leq 125^{\circ}\text{C}$)

Watchdog Timer (WDT) Section

- Watchdog Timer Accuracy (tow): -17.8% to 21.7% ($-40^{\circ}\text{C} \leq T_a \leq 125^{\circ}\text{C}$)

PACKAGES

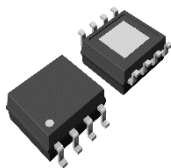

HSOP-8E

5.2 x 6.2 x 1.6* mm
*maximum dimension

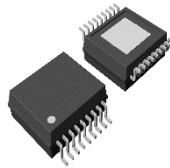

HSOP-18

5.2 x 6.2 x 1.6* mm
*maximum dimension

APPLICATIONS

- Factory Automation Equipment, Smart meters
- Surveillance Camera, Vending Machines

TYPICAL APPLICATION

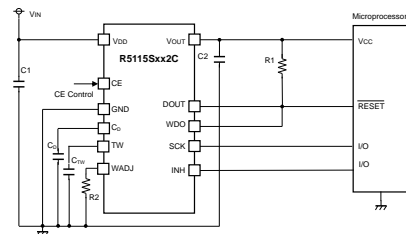

C_{IN} , C_{OUT} : 0.1 μ F, Ceramic capacitor
 C_{TW} : Capacitor for setting watchdog timer
 C_D : Capacitor for setting reset delay time

SELECTION GUIDE

Product Name	Package	Quantity per Reel
R5115Sxx1*-E2-YE	HSOP-8E	1,000 pcs
R5115Sxx2*-E2-YE	HSOP-18	1,000 pcs

xx: Set output voltage (V_{SET}) and set detection voltage ($-V_{DSET}$) options. Assign a code starting from 01 to designate a desired combination of V_{SET} and $-V_{DSET}$.

*: Other functional options

*	Package	WADJ	WDO Pin	RESETB/DOUT Pin
A	HSOP-8E	Fixed ⁽²⁾	No	RESETB
B	HSOP-8E	No	No	RESETB
C	HSOP-18	Adjustable ⁽³⁾	Yes	DOUT

⁽¹⁾ R5115Sxx1A, R5115Sxx2C only

⁽²⁾ Internally fixed

⁽³⁾ Adjustable using the WADJ pin

R5115x-Y

No. EY-409-190711

SELECTION GUIDE

A set detection voltage, a package type, a WADJ function, a WDO pin and a RESETB/DOUT pin are user-selectable options.

Selection Guide

Product Name	Package	Quantity per Reel	Pb Free	Halogen Free
R5115Sxx1*-E2-YE	HSOP-8E	1,000 pcs	Yes	Yes
R5115Sxx2*-E2-YE	HSOP-18	1,000 pcs	Yes	Yes

xx: Set output voltage (V_{SET}) and set detection voltage ($-V_{DSET}$) options

Assign a code starting from 01 to designate a desired combination of V_{SET} and $-V_{DSET}$.

*: Other functional options

*	Package	WDT Type	WADJ Function	WDO Pin	RESETB/DOUT Pin
A	HSOP-8E	Window	Fixed ⁽¹⁾	No	RESETB
B	HSOP-8E	Window	No	No	RESETB
C	HSOP-18	Window	Adjustable ⁽²⁾	Yes	DOUT

⁽¹⁾ internally fixed

⁽²⁾ adjustable using the WADJ pin

BLOCK DIAGRAMS

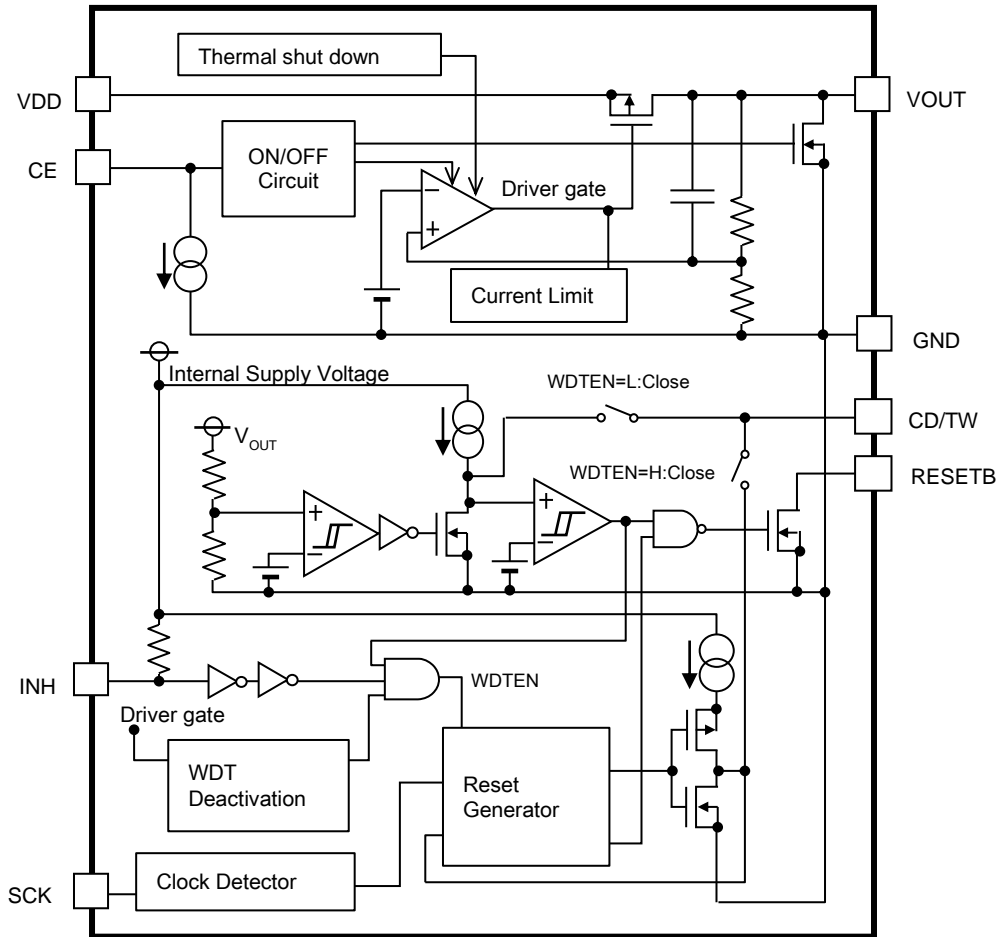

R5115Sxx1A Block Diagram

R5115x-Y

No. EY-409-190711

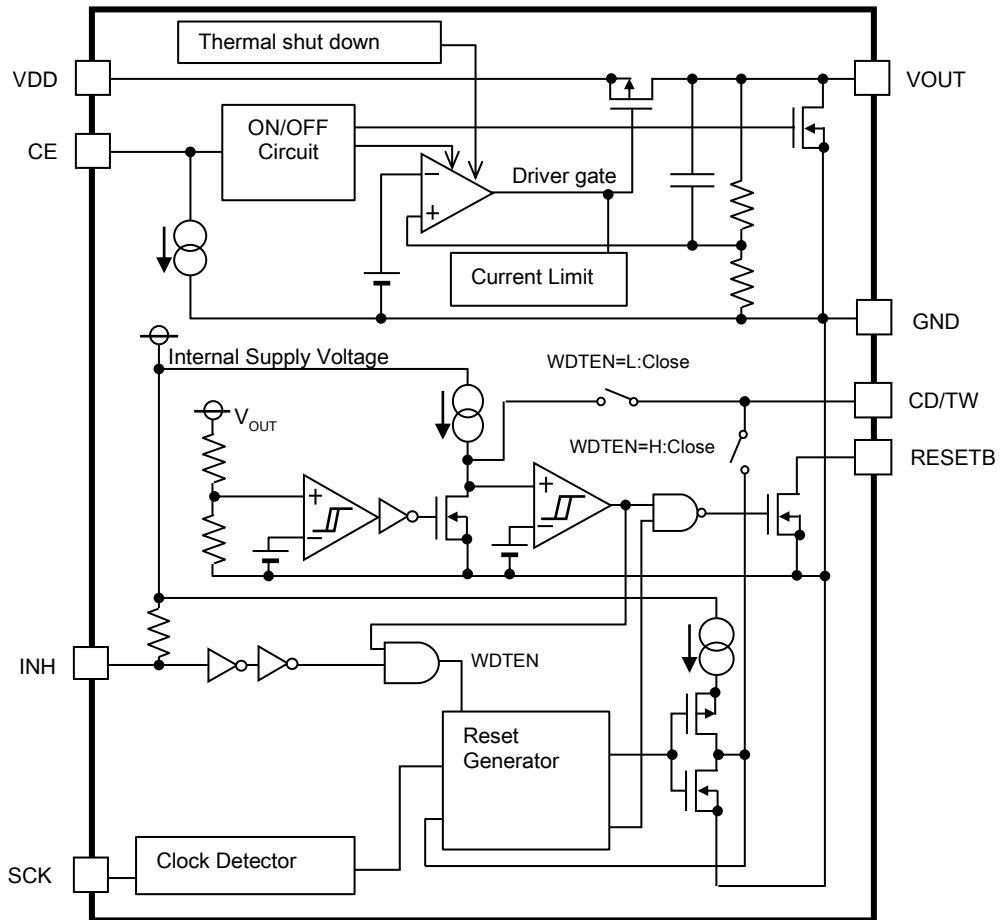
**R5115Sxx1B Block Diagram**

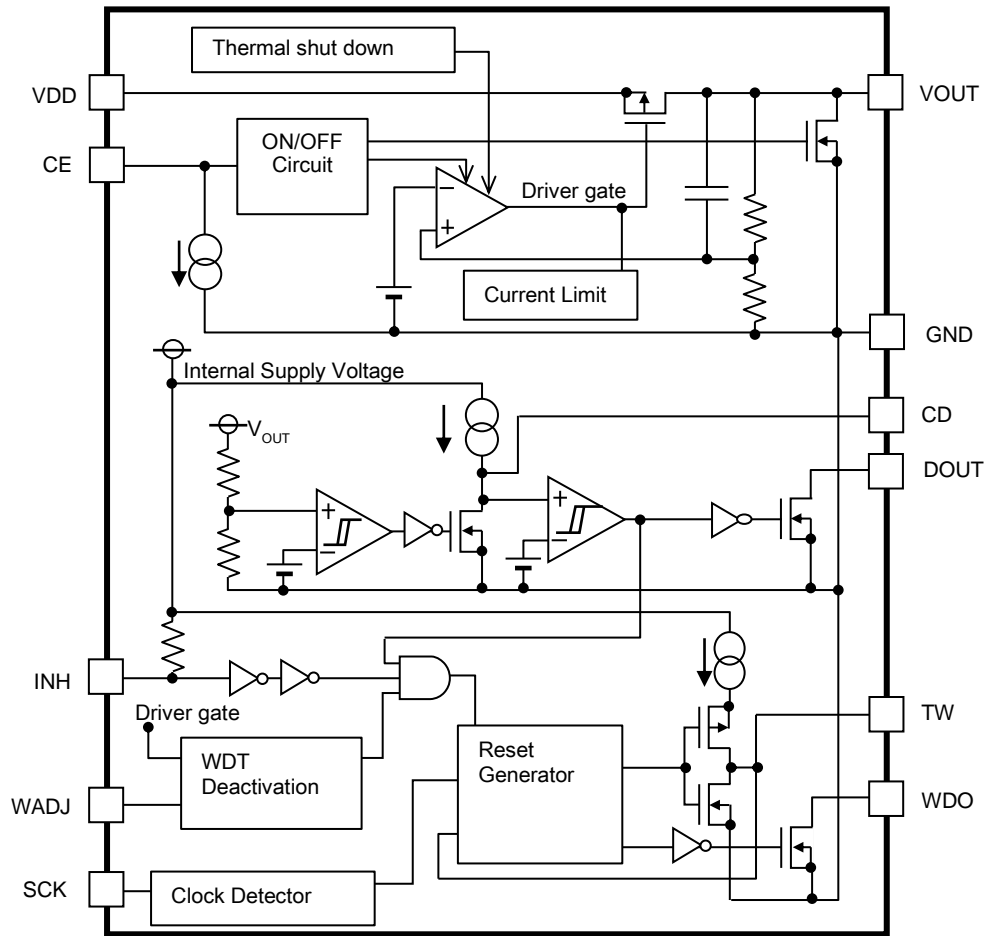

R5115Sxx2C Block Diagram

PIN DESCRIPTION

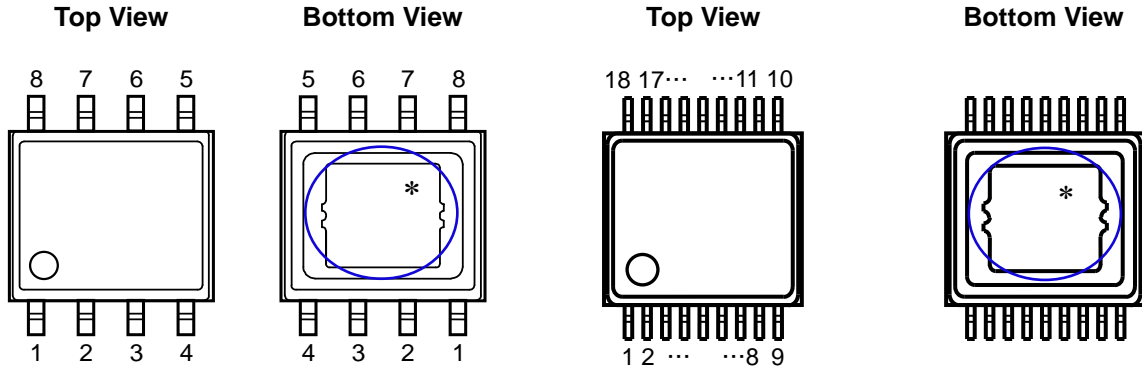

HSOP-8E Pin Configuration

HSOP-18 Pin Configuration

* The tab on the bottom of the package shown by blue circle is a substrate potential (GND). It is recommended that this tab be connected to the ground plane on the board but it is possible to leave the tab floating.

HSOP-8E Pin Description, R5115Sxx1A/R5115Sxx1B

Pin No.	Pin Name	Description
1	VDD	Power Supply Pin
2	CD/TW	Watchdog Timer Monitoring Time Setting Pin/ Voltage Detector Reset Delay Time (Power-on Reset Time) Setting Pin
3	CE	Chip Enable Pin, Active-high
4	GND	Ground Pin
5	INH	Inhibit Pin, Active-low
6	SCK	Watchdog Timer Pulse Inputting Pin
7	RESETB ⁽¹⁾	Reset Output Pin, Active-low, Nch Open Drain Output
8	VOUT	Voltage Regulator Output Pin

⁽¹⁾ The RESET pin voltage should be pulled up to the appropriate level using an external resistor.

HSOP-18 Pin Description, R5115Sxx2C

Pin No.	Pin Name	Description
1	VDD	Power Supply Pin
2	NC	No Connection
3	CD	Voltage Detector Reset Delay Time (Power-on Reset Time) Setting Pin
4	NC	No Connection
5	TW	Watchdog Timer Monitoring Time Setting Pin
6	NC	No Connection
7	CE	Chip Enable Pin, Active-high
8	NC	No Connection
9	GND	Ground Pin
10	WADJ	Watchdog Timer Operating Threshold Pin
11	INH	Inhibit Pin, Active-low
12	NC	No Connection
13	SCK	Watchdog Timer Pulse Input Pin
14	NC	No Connection
15	WDO ⁽¹⁾	Watchdog Timer Output Pin, Nch Open Drain Output
16	DOUT ⁽²⁾	RESET Output Pin, Active-low, Nch Open Drain Output
17	NC	No Connection
18	VOOUT	Voltage Regulator Output Pin

⁽¹⁾ The WDO pin voltage should be pulled up to the appropriate level using an external resistor.

⁽²⁾ The DOUT pin voltage should be pulled up to the appropriate level using an external resistor.

R5115x-Y

No. EY-409-190711

Equivalent Circuits of Individual Pins

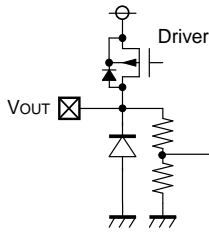

Equivalent Circuit for VOUT Pin

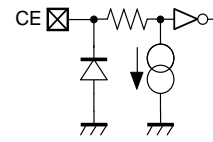

Equivalent Circuit for CE Pin

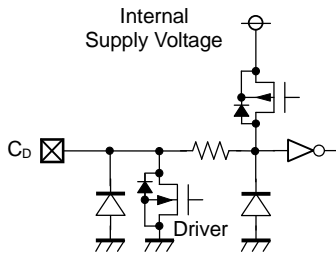

Equivalent Circuit for CD Pin

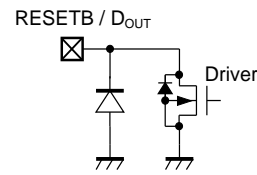

**Equivalent Circuit for RESETB Pin (R5115Sxx1x)/
Equivalent Circuit for DOUT Pin (R5115Sxx2C)**

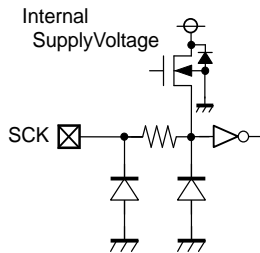

Equivalent Circuit for SCK Pin

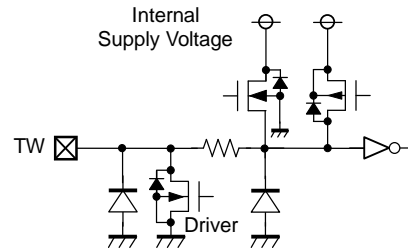

Equivalent Circuit for TW Pin

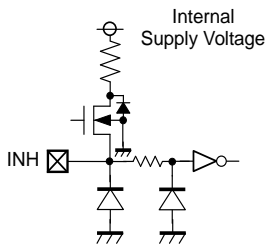

Equivalent Circuit for INH Pin

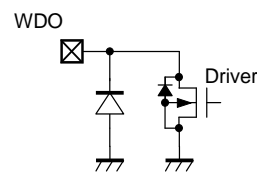

Equivalent Circuit for WDO Pin (R5115Sxx2C)

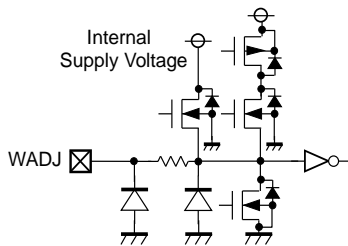

Equivalent Circuit for WADJ Pin (R5115Sxx2C)

ABSOLUTE MAXIMUM RATINGS

Absolute Maximum Ratings

Symbol	Parameter		Rating	Unit	
V _{IN}	Input Voltage		-0.3 to 50	V	
	Peak Voltage ⁽¹⁾		60	V	
V _{CE}	CE Pin Input Voltage		-0.3 to 50	V	
V _{OUT}	VOUT Pin Output Voltage		-0.3 to V _{IN} + 0.3 ≤ 50	V	
V _{CD}	CD Pin Output Voltage		-0.3 to 7.0	V	
V _{TW}	TW Pin Output Voltage		-0.3 to 7.0	V	
V _{RESETB}	RESETB Pin Output Voltage		-0.3 to 7.0	V	
V _{DOUT}	DOUT Pin Output Voltage		-0.3 to 7.0	V	
V _{WDO}	WDO Pin Output Voltage		-0.3 to 7.0	V	
V _{SCK}	SCK Pin Input Voltage		-0.3 to 7.0	V	
V _{INH}	INH Pin Input Voltage		-0.3 to 7.0	V	
V _{WADJ}	WADJ Pin Output Voltage		-0.3 to 7.0	V	
I _{RESETB}	RESETB Pin Current		16	mA	
I _{DOUT}	DOUT Pin Current		16	mA	
I _{WDO}	WDO Pin Current		16	mA	
P _D	Power ⁽²⁾ Dissipation	HSOP-8E	JEDEC STD. 51-7	3600	mW
		HSOP-18	JEDEC STD. 51-7	3900	
T _j	Junction Temperature Range		-40 to 150	°C	
T _{stg}	Storage Temperature Range		-55 to 150	°C	

ABSOLUTE MAXIMUM RATINGS

Electronic and mechanical stress momentarily exceeded absolute maximum ratings may cause permanent damage and may degrade the life time and safety for both device and system using the device in the field. The functional operation at or over these absolute maximum ratings are not assured.

⁽¹⁾ Application time is 200 ms or less.

⁽²⁾ Refer to *POWER DISSIPATION* for detailed information

R5115x-Y

No. EY-409-190711

RECOMMENDED OPERATING CONDITIONS**Recommended Operating Conditions**

Symbol	Parameter	Rating	Unit
V_{IN}	Input Voltage	3.5 to 42.0	V
V_{CE}	CE Pin Input Voltage	0 to 42.0	V
V_{SCK}	SCK Pin Input Voltage	0 to 5.5	V
V_{INH}	INH Pin Input Voltage	0 to 5.5	V
T_a	Operating Temperature Range	-40 to 125	°C

RECOMMENDED OPERATING CONDITIONS

All of electronic equipment should be designed that the mounted semiconductor devices operate within the recommended operating conditions. The semiconductor devices cannot operate normally over the recommended operating conditions, even if they are used over such conditions by momentary electronic noise or surge. And the semiconductor devices may receive serious damage when they continue to operate over the recommended operating conditions.

ELECTRICAL CHARACTERISTICS

$C_{IN} = C_{OUT} = 0.1\mu\text{F}$, $V_{IN} = 14\text{ V}$, unless otherwise noted.

The specifications surrounded by are guaranteed by design engineering at $-40^{\circ}\text{C} \leq T_a \leq 125^{\circ}\text{C}$.

R5115Sxxxx-YE Electrical Characteristics

($T_a = 25^{\circ}\text{C}$)

Symbol	Parameter	Test Conditions/Comments	Min.	Typ.	Max.	Unit
I_{SS}	Supply Current	$I_{OUT} = 0\text{ mA}$ R5115Sxx1A/ R5115Sxx2C		8.5	18	μA
		$I_{OUT} = 0\text{ mA}$ R5115Sxx1B		13.5	23	μA
$I_{standby}$	Standby Current	$V_{IN} = 42\text{ V}$, $V_{CE} = 0\text{ V}$		0.2	1.0	μA
I_{PD}	CE Pull-down Constant Current	$V_{CE} = 42\text{ V}$		0.2	0.6	μA
V_{CEH}	CE Input Voltage, High		2.2		42	V
V_{CEL}	CE Input Voltage, Low				1.0	V

VR Section

($T_a = 25^{\circ}\text{C}$)

Symbol	Parameter	Test Conditions/Comments	Min.	Typ.	Max.	Unit	
V_{OUT}	Output Voltage	$I_{OUT} = 1\text{ mA}$	$T_a = 25^{\circ}\text{C}$		×0.994	×1.006	V
			$-40^{\circ}\text{C} \leq T_a \leq 125^{\circ}\text{C}$		×0.984	×1.016	V
$\frac{\Delta V_{OUT}}{\Delta I_{OUT}}$	Load Regulation	$V_{IN} = V_{SET} + 3.0\text{ V}$ $1\text{ mA} \leq I_{OUT} \leq 250\text{ mA}$	-20	0	50	mV	
V_{DIF}	Dropout Voltage	$I_{OUT} = 250\text{ mA}$	$V_{SET} = 3.3$		1.0	2.0	V
			$V_{SET} = 5.0$		0.80	1.5	V
$\frac{\Delta V_{OUT}}{\Delta V_{IN}}$	Line Regulation	$3.5\text{ V} \leq V_{SET} + 0.5\text{ V} \leq V_{IN} \leq 42\text{ V}$ $I_{OUT} = 1\text{ mA}$		0.01	0.02	%/V	
I_{LIM}	Output Current Limit	$V_{IN} = V_{SET} + 3.0\text{ V}$	320	440	530	mA	
I_{SC}	Short-circuit Current Limit	$V_{IN} = 5\text{ V}$, $V_{OUT} = 0\text{ V}$	70	95	135	mA	
T_{TSD}	Thermal Shutdown Temperature Threshold, rising	Junction Temperature	150	170		$^{\circ}\text{C}$	
T_{TSR}	Thermal Shutdown Temperature Threshold, falling	Junction Temperature	125	140		$^{\circ}\text{C}$	

R5115x-Y

No. EY-409-190711

$C_{IN} = C_{OUT} = 0.1\mu F$, $V_{IN} = 14 V$, unless otherwise noted.

The specifications surrounded by are guaranteed by design engineering at $-40^{\circ}C \leq T_a \leq 125^{\circ}C$.

R5115Sxxxx-YE Electrical Characteristics (Continued)

VD Section

($T_a = 25^{\circ}C$)

Symbol	Parameter	Test Conditions/Comments	Min.	Typ.	Max.	Unit
$-V_{DET}$	Detection Voltage	$V_{DD} = V_{OUT}$ (V_{OUT} Detection)	$T_a = 25^{\circ}C$	x0.994	x1.006	V
		$-40^{\circ}C \leq T_a \leq 125^{\circ}C$	x0.984		x1.016	
V_{HYS}	Detection Threshold Hysteresis		$\frac{-V_{DSET}}{x0.015}$	$-V_{DSET} \times 0.02$	$\frac{-V_{DSET}}{x0.025}$	V
t_{RESET}	Reset Delay Time (Power-on Reset)	$C_D = 0.22 \mu F$	184	220	253	ms
V_{RESETB}	RESETB Pull-up Voltage	R5115Sxx1A / R5115Sxx1B			5.5	V
V_{DOUT}	DOUT Pull-up Voltage	R5115Sxx2C			5.5	V
$I_{OUTRSTB}$	Nch Driver Output Current (RESETB Output Pin)	R5115Sxx1A / R5115Sxx1B $V_{IN} = 3.5 V$, $V_{RESETB} = 0.1 V$	0.3	0.6		mA
$I_{LEAKRSTB}$	Nch Driver Leakage Current (RESETB Output Pin)	R5115Sxx1A / R5115Sxx1B $V_{RESETB} = 5.5 V$			0.3	μA
$I_{OUTDOUT}$	Nch Driver Output Current (DOUT Output Pin)	R5115Sxx2C $V_{IN} = 3.5 V$, $V_{DOUT} = 0.1 V$	0.3	0.6		mA
$I_{LEAKDOUT}$	Nch Driver Leakage Current (DOUT Output Pin)	R5115Sxx2C $V_{DOUT} = 5.5 V$			0.3	μA
R_{LCD}	CD Auto-discharge (Nch Tr. On-resistance)	$V_{CE} = 0 V$, $V_{CD} = 0.1 V$		7.5	20	k Ω

$C_{IN} = C_{OUT} = 0.1\mu\text{F}$, $V_{IN} = 14\text{ V}$, unless otherwise noted.

The specifications surrounded by are guaranteed by design engineering at $-40^{\circ}\text{C} \leq T_a \leq 125^{\circ}\text{C}$.

R5115Sxxxx-YE Electrical Characteristics (Continued)

WDT Section

($T_a = 25^{\circ}\text{C}$)

Symbol	Parameter	Test Conditions/Comments	Min.	Typ.	Max.	Unit
t_{OW}	Open Window Time	$C_{TW} = 10\text{ nF}$	14.8	18.0	21.9	ms
t_{CW}	Closed Window Time	$C_{TW} = 10\text{ nF}$	3.8	4.5	5.3	ms
t_{OWL}	Long Open Window Time	$C_{TW} = 10\text{ nF}$	37	80	150	ms
t_{IGN}	Pulse Ignoring Time	$C_{TW} = 10\text{ nF}$	14.0	18.0	22.9	ms
t_{WR}	Reset Time	$C_{TW} = 10\text{ nF}$	7.2	9.0	10.7	ms
V_{SCKH}	SCK Input, High		1.5		5.5	V
V_{SCKL}	SCK Input, Low		0		0.65	V
$V_{INH H}$	INH Input, High		1.5		5.5	V
$V_{INH L}$	INH Input, Low		0		0.5	V
I_{INH}	INH Pull-up Current	$V_{INH} = 0\text{ V}$	4.0	8.0	11.5	μA
$I_{OWDTACT}$	WDT Activating Threshold Current	R5115Sxx1A		1.2	2.2	mA
$I_{OWDTDEACT}$	WDT Deactivating Threshold Current	R5115Sxx1A	0.6	1.0		mA
$\frac{I_{OUT}}{I_{WADJ}}$ (1)	WADJ Pin Current Ratio (WDT is not active.)	R5115Sxx2C $V_{WADJ} = 0\text{ V}$, $I_{OUT} = 10\text{ mA}$	1000	1600	3200	-
$\frac{I_{OUT}}{I_{WADJ}}$ (2)	WADJ Pin Current Ratio (WDT is active.)	R5115Sxx2C $V_{WADJ} = 1.0\text{ V}$, $I_{OUT} = 10\text{ mA}$	800	1200	2400	-
V_{WADJ_TH}	WADJ Pin Threshold Voltage	R5115Sxx2C	0.6	0.7	0.8	V
t_{SCKWH}	SCK Minimum Input Pulse Width, High	$V_{SCKL} = 0.5$, $V_{SCKH} = 1.6$	500			ns
t_{SCKWL}	SCK Minimum Input Pulse Width, Low	$V_{SCKL} = 0.5$, $V_{SCKH} = 1.6$	1500			ns
V_{WDO}	WDO Pull-up Voltage				5.5	V
I_{OUTWDO}	Nch Driver Output Current (WDO Output Pin)	R5115Sxx2C $V_{IN} = 3.5\text{ V}$, $V_{WDO} = 0.1\text{ V}$	0.7	1.5		mA
$I_{LEAKWDO}$	Nch Driver Leakage Current (WDO Output Pin)	R5115Sxx2C $V_{WDO} = 5.5\text{ V}$			0.3	μA
R_{LTW}	C_{TW} Auto-discharge (Nch Tr. On-resistance)	$V_{CE} = 0\text{ V}$, $V_{TW} = 0.1\text{ V}$		7.5	20	k Ω

R5115x-Y

No. EY-409-190711

Product-specific Electrical Characteristics: Voltage Regulator Section

Product Name	VR Section					
	V _{OUT}					
	Ta = 25°C			-40 ≤ Ta ≤ 125°C		
	Min.	Typ.	Max.	Min.	Typ.	Max.
R5115S01xx	4.9700	5.000	5.0300	4.9200	5.000	5.0800
R5115S02xx	4.9700	5.000	5.0300	4.9200	5.000	5.0800
R5115S03xx	4.9700	5.000	5.0300	4.9200	5.000	5.0800
R5115S04xx	4.9700	5.000	5.0300	4.9200	5.000	5.0800
R5115S05xx	3.2802	3.300	3.3198	3.2472	3.300	3.3528
R5115S06xx	3.2802	3.300	3.3198	3.2472	3.300	3.3528
R5115S07xx	3.2802	3.300	3.3198	3.2472	3.300	3.3528
R5115S08xx	4.9700	5.000	5.0300	4.9200	5.000	5.0800
R5115S09xx	4.9700	5.000	5.0300	4.9200	5.000	5.0800
R5115S10xx	4.9700	5.000	5.0300	4.9200	5.000	5.0800
R5115S11xx	4.9700	5.000	5.0300	4.9200	5.000	5.0800

Product-specific Electrical Characteristics: Voltage Detector Section

Product Name	VD Section								
	-V _{DET}						V _{HYS}		
	Ta = 25°C			-40 ≤ Ta ≤ 125°C					
	Min.	Typ.	Max.	Min.	Typ.	Max.	Min.	Typ.	Max.
R5115S01xx	4.5724	4.600	4.6276	4.5264	4.600	4.6736	0.0690	0.0920	0.1150
R5115S02xx	3.2802	3.300	3.3198	3.2472	3.300	3.3528	0.0495	0.0660	0.0825
R5115S03xx	3.9760	4.000	4.0240	3.9360	4.000	4.0640	0.0600	0.0800	0.1000
R5115S04xx	4.4730	4.500	4.5270	4.4280	4.500	4.5720	0.0675	0.0900	0.1125
R5115S05xx	2.9820	3.000	3.0180	2.9520	3.000	3.0480	0.0450	0.0600	0.0750
R5115S06xx	2.8826	2.900	2.9174	2.8536	2.900	2.9464	0.0435	0.0580	0.0725
R5115S07xx	2.6838	2.700	2.7162	2.6568	2.700	2.7432	0.0405	0.0540	0.0675
R5115S08xx	4.3736	4.400	4.4264	4.3296	4.400	4.4704	0.0660	0.0880	0.1100
R5115S09xx	4.0754	4.100	4.1246	4.0344	4.100	4.1656	0.0615	0.0820	0.1025
R5115S10xx	4.1748	4.200	4.2252	4.1328	4.200	4.2672	0.0630	0.0840	0.1050
R5115S11xx	2.4850	2.500	2.5150	2.4600	2.500	2.5400	0.0375	0.0500	0.0625

THEORY OF OPERATION

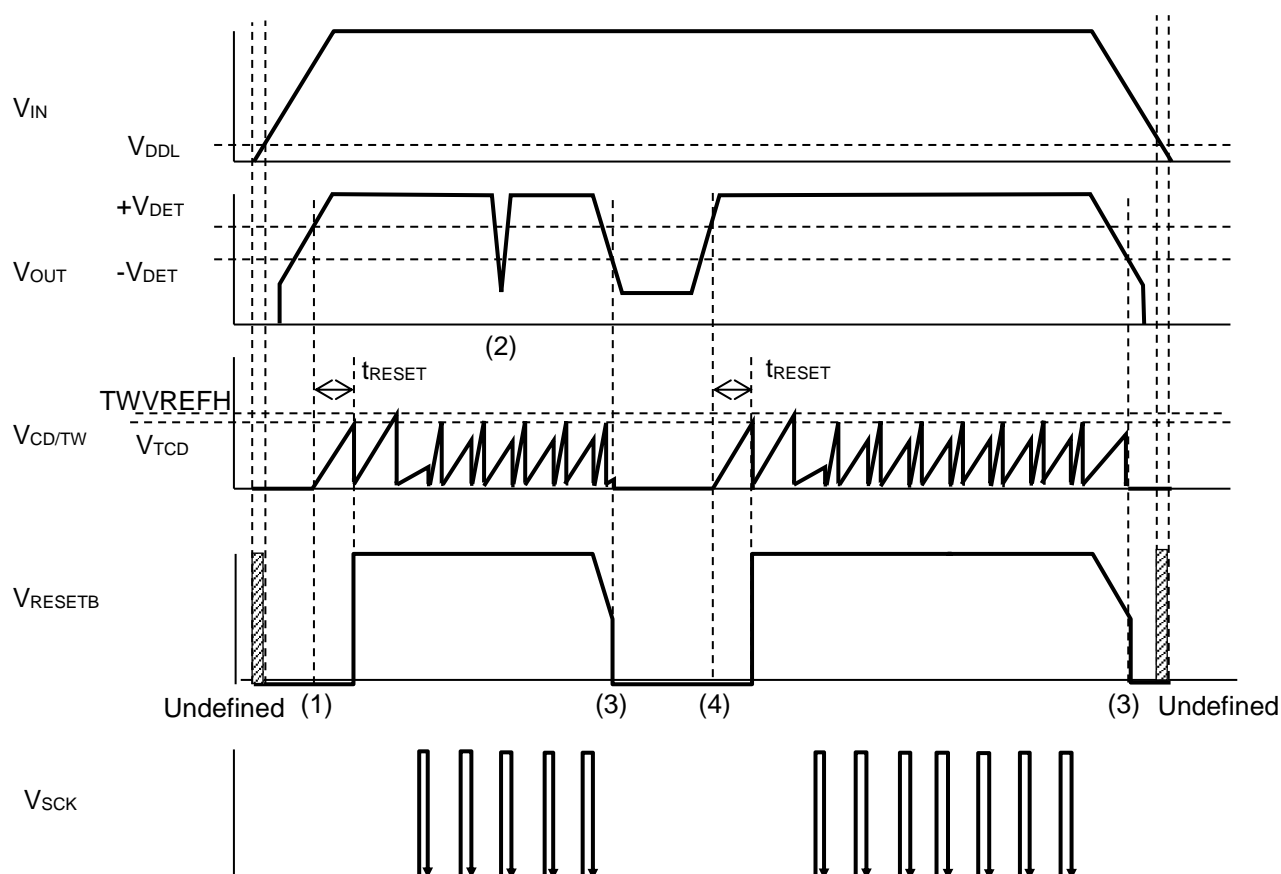

R5115Sxx1A/ R5115Sxx1B VD Timing Chart

- (1) When the output voltage (V_{OUT}) of a voltage regulator (VR) becomes more than the reset voltage ($+V_{DET}$), the RESETB pin voltage (V_{RESETB}) becomes high after the reset delay time (t_{RESET}). During t_{RESET} , the CD/TW pin serves as a rest delay time setting pin. When V_{RESETB} becomes high, the CD/TW pin serves as a watchdog timer setting pin.
- (2) When V_{OUT} becomes lower than the detection voltage ($-V_{DET}$) and when that period is shorter than the delay time (t_{DELAY}), Typ. 30 μ s or lower, V_{RESETB} remains high and does not go into the detecting state.
- (3) When V_{OUT} becomes lower than $-V_{DET}$, V_{RESETB} becomes low after a 30- μ s (Typ.) t_{DELAY} , and the voltage detector (VD) goes into the detecting state.
- (4) When V_{OUT} becomes higher than $+V_{DET}$, V_{RESETB} becomes high after t_{RESET} . ($V_{TCD} = \text{Typ.} 1 \text{ V}$)

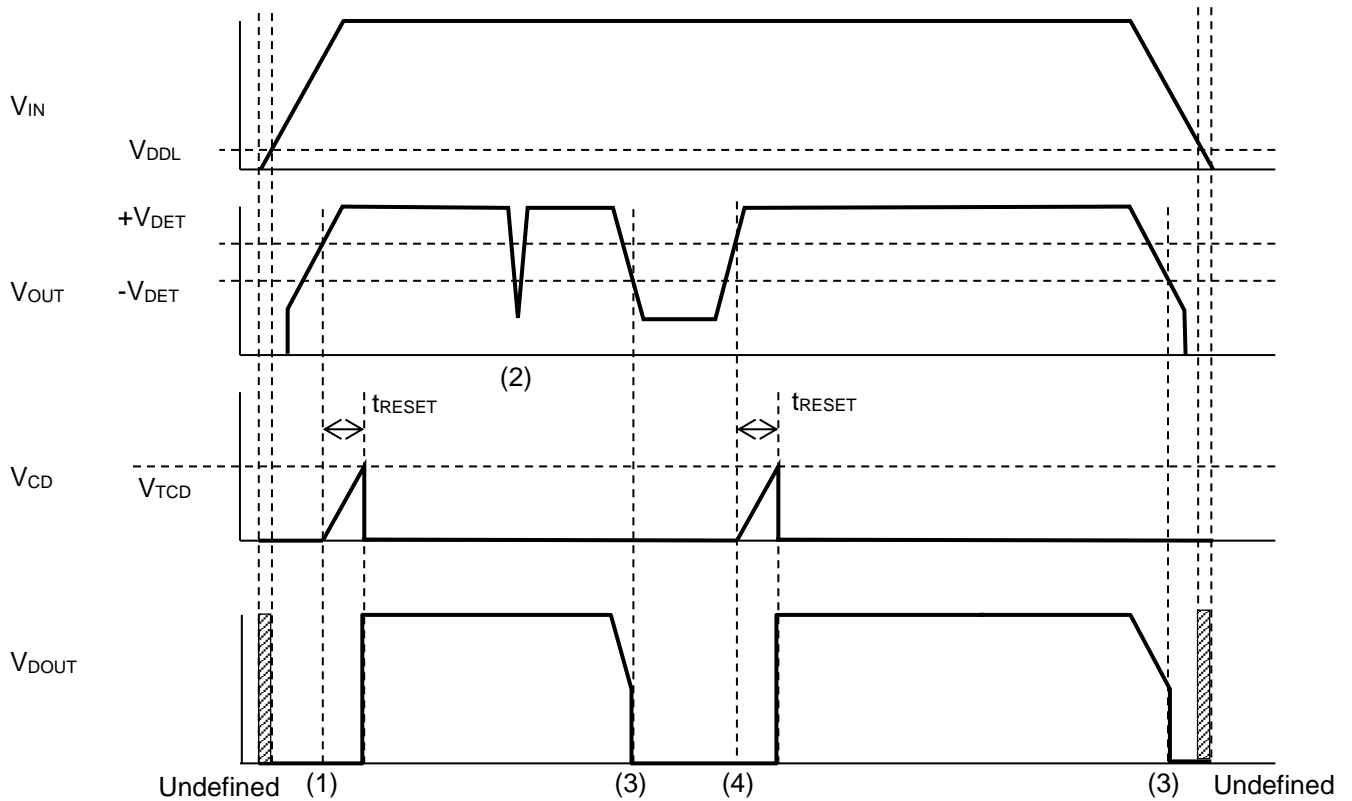

R5115Sxx2C VD Timing Chart

- (1) When the output voltage (V_{OUT}) of a voltage regulator (VR) becomes higher than the reset voltage ($+V_{DET}$), the DOUT pin voltage (V_{DOUT}) becomes high after the reset delay time (t_{RESET}).
- (2) When V_{OUT} becomes lower than the detection voltage ($-V_{DET}$) and when that period is shorter than the delay time (t_{DELAY}), Typ. 30 μ s or lower, V_{DOUT} remains high and does not go into the detecting state.
- (3) When V_{OUT} becomes lower than $-V_{DET}$, V_{DOUT} becomes low after a 30- μ s (Typ.) t_{DELAY} , and the voltage detector (VD) goes into the detecting state.
- (4) When V_{OUT} becomes higher than $+V_{DET}$, V_{DOUT} becomes high after t_{RESET} . ($V_{TCD} = \text{Typ.} 1 \text{ V}$)

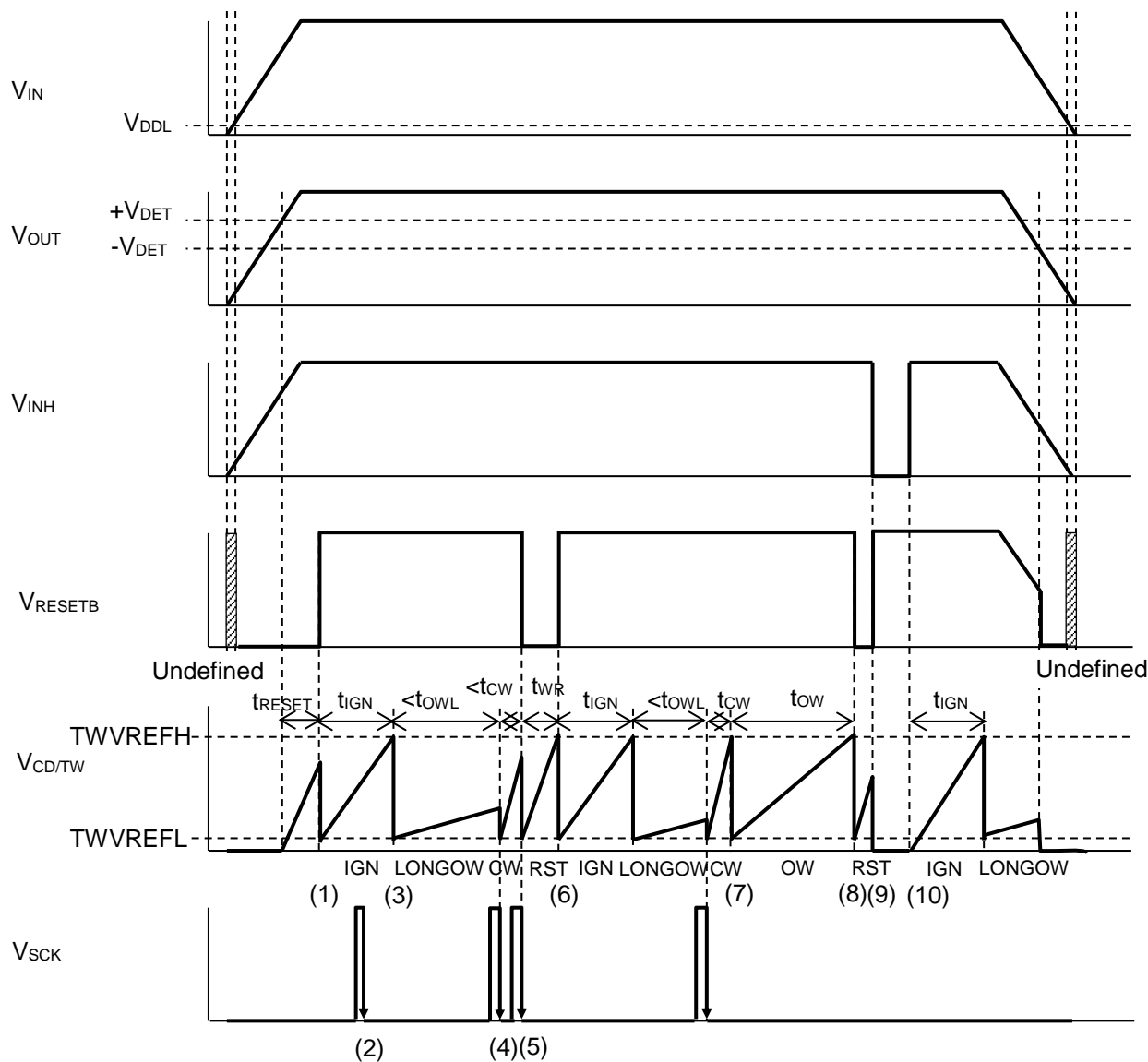

R5115Sxx1A/R5115Sxx1B WDT Timing Chart, Window Type

- (1) When the output voltage (V_{OUT}) of a voltage regulator (VR) becomes higher than the reset voltage ($+V_{DET}$), the RESETB pin voltage (V_{RESETB}) becomes high after the reset delay time (t_{RESET}), and the watchdog timer (WDT) starts monitoring a pulse. After that, the CD/TW pin voltage ($V_{CD/TW}$) repeats charge and discharge. As a result, a sawtooth wave is generated. The WDT has four states: Ignoring, Reset, Open Window and Closed Window. In each state, the CD/TW pin is charged from 0 V or $TWVREFL$ (Typ. 0.08 V).
- (2) After WDT starts, WDT is in an ignoring state until $V_{CD/TW}$ is charged up to $TWVREFH$ (Typ. 2V). So, a pulse to the SCK pin is ignored during the ignoring state.
- (3) When $V_{CD/TW}$ is charged up to $TWVREFH$ during the ignoring state, the CD/TW pin starts discharging and WDT goes into a long open window state. While this long open window state works as an open window state, it is four times longer than the normal open window state.
- (4) When a pulse is sent to the SCK pin before $V_{CD/TW}$ reaches $TWVREFH$ during the open window state, the CD/TW pin starts discharging and WDT goes into a closed window state.
- (5) When a pulse is sent to the SCK pin before $V_{CD/TW}$ reaches $TWVREFH$ during the closed window state, the CD/TW pin starts discharging and WDT goes into a reset state. During the reset state, V_{RESETB} becomes low.
- (6) When $V_{CD/TW}$ reaches $TWVREFH$ during the reset state, the CD/TW pin starts discharging and WDT goes into an ignoring state.
- (7) When a pulse is not sent to the SCK pin before $V_{CD/TW}$ reaches $TWVREFH$ during a closed window state, the CD/TW pin starts discharging and WDT goes into an open window state.
- (8) When a pulse is not sent to the SCK pin before $V_{CD/TW}$ reaches $TWVREFH$ during the open window state, the CD/TW pin starts discharging and WDT goes into a reset state.
- (9) When the INH pin voltage (V_{INH}) is set to low, WDT stops monitoring. So, the voltage detector (VD) determines whether V_{RESETB} is set to high/low, or $V_{CD/TW}$ is charged/discharged.
- (10) When V_{INH} is changed from low to high, WDT goes into the ignoring state and restarts monitoring a pulse.

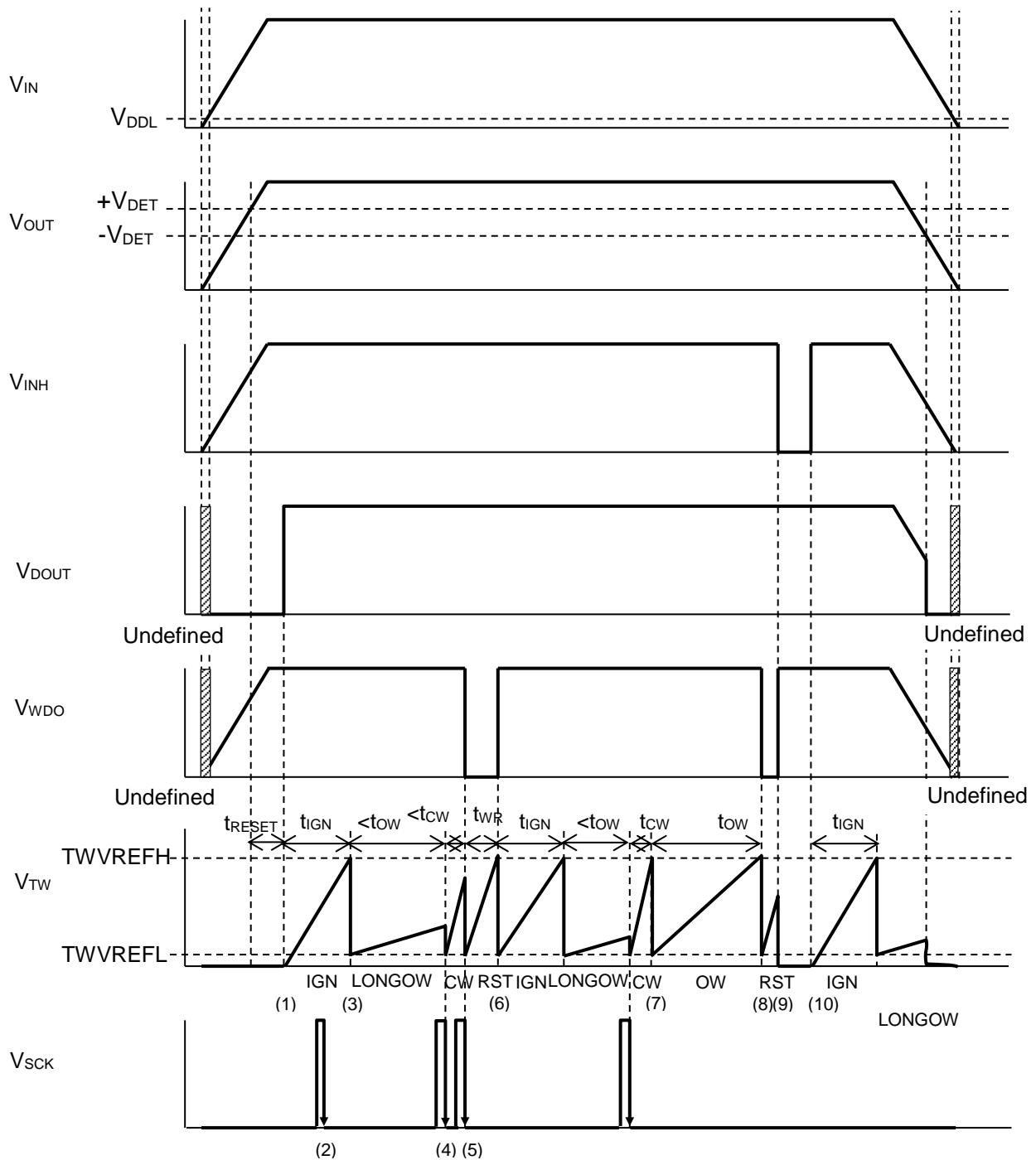

R5115Sxx2C WDT Timing Chart, Window Type

- (1) When the output voltage (V_{OUT}) of a voltage regulator (VR) becomes higher than the reset voltage ($+V_{DET}$), the DOUT pin voltage (V_{DOUT}) becomes high after the reset delay time (t_{RESET}), and the watchdog timer (WDT) starts monitoring a pulse. After that, the TW pin voltage (V_{TW}) repeats charge and discharge. As a result, a sawtooth wave is generated. WDT has four states: Ignoring, Reset, Open Window and Closed Window. In each state, the TW pin is charged from 0 V or $TWVREFL$ (Typ.0.08 V).
- (2) After WDT starts, WDT is in an ignoring state until V_{TW} is charged up to $TWVREFH$. So, a pulse to the SCK pin is ignored during the ignoring state.
- (3) When V_{TW} is charged up to $TWVREFH$ during the ignoring state, the TW pin starts discharging and WDT goes into a long open window state. While this long open window state works as an open window state, it is four times longer than the normal open window state.
- (4) When a pulse is sent to the SCK pin before V_{TW} reaches $TWVREFH$ during the open window state, the TW pin starts discharging and WDT goes into a closed window state.
- (5) When a pulse is sent to the SCK pin before V_{TW} reaches $TWVREFH$ during the close window state, the TW pin starts discharging and WDT goes into a reset state. During the reset state, V_{DOUT} becomes low.
- (6) When V_{TW} reaches $TWVREFH$ during the reset state, the TW pin starts discharging and WDT goes into an ignoring state.
- (7) When a pulse is not sent to the SCK pin before V_{TW} reaches $TWVREFH$ during a closed window state, the TW pin starts discharging and WDT goes into an open window state
- (8) When a pulse is not sent to the SCK pin before V_{TW} reaches $TWVREFH$ during the open window state, the TW pin starts discharging and WDT goes into a reset state
- (9) When the INH pin voltage (V_{INH}) is set to low, WDT stops monitoring. Then, the WDO pin voltage (V_{WDO}) is fixed to high and V_{TW} is fixed to low.
- (10) When V_{INH} is changed from low to high, WDT goes into the ignoring state and restarts monitoring a pulse.

Delay Operation and Reset Delay Time

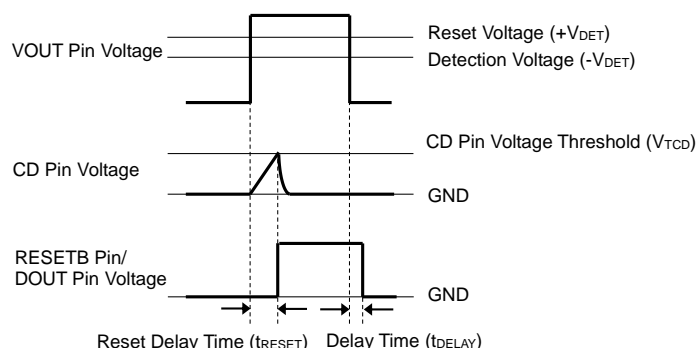

RESETB Pin: R5115Sxx1A/ R5115Sxx1B
DOUT Pin: R5115Sxx2C

Delay Time Operation Timing Chart

When the VOUT pin voltage (V_{OUT}) becomes higher than the reset voltage ($+V_{\text{DET}}$), the CD pin voltage (V_{CD}) increases as the external capacitor starts charging. The RESETB pin voltage (V_{RESETB})/ the DOUT pin voltage (V_{DOUT}) remains low until V_{CD} reaches the CD pin voltage threshold (V_{TCD}). When V_{CD} becomes higher than V_{TCD} , V_{RESETB} or V_{DOUT} changes from low to high. The reset delay time (t_{RESET}) starts when the V_{OUT} becomes higher than $+V_{\text{DET}}$ and ends when $V_{\text{DOUT}}/V_{\text{RESETB}}$ changes from low to high. When $V_{\text{DOUT}}/V_{\text{RESETB}}$ changes from low to high, the electrical charge charged in the external capacitor starts discharging. The delay time (t_{DELAY}) starts when V_{OUT} becomes lower than the detection voltage ($-V_{\text{DET}}$) and ends when $V_{\text{DOUT}}/V_{\text{RESETB}}$ changes from high to low. It is not dependent on the capacitance of the external capacitor.

Method of Calculating the Reset Delay Time

The reset delay time (t_{RESET}) can be calculated by the following equation using an external capacitance (C_{D}):

$$t_{\text{RESET}} (\text{s}) = 1.0 \times C_{\text{D}} (\text{F}) / (1.0 \times 10^{-6})$$

To make the VOUT/ SENSE pin voltage rises slower than 0.1 V/s, place a 100-pF or more capacitor (C_{D}).

t_{RESET} starts when the RESETB/DOUT pin is pulled up to 5 V using a 100-k Ω resistor, and a 1.5-V to ($-V_{\text{DET}}$) + 2.0-V pulse voltage is applied to the VOUT pin. It ends when V_{OUT} reaches 2.5 V.

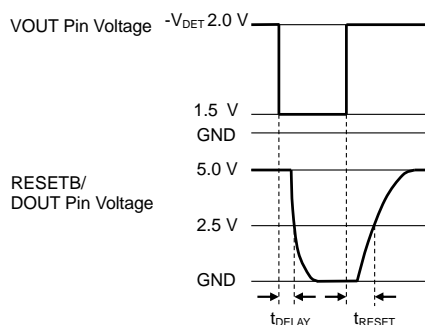

Watchdog Timer State Transition Diagram

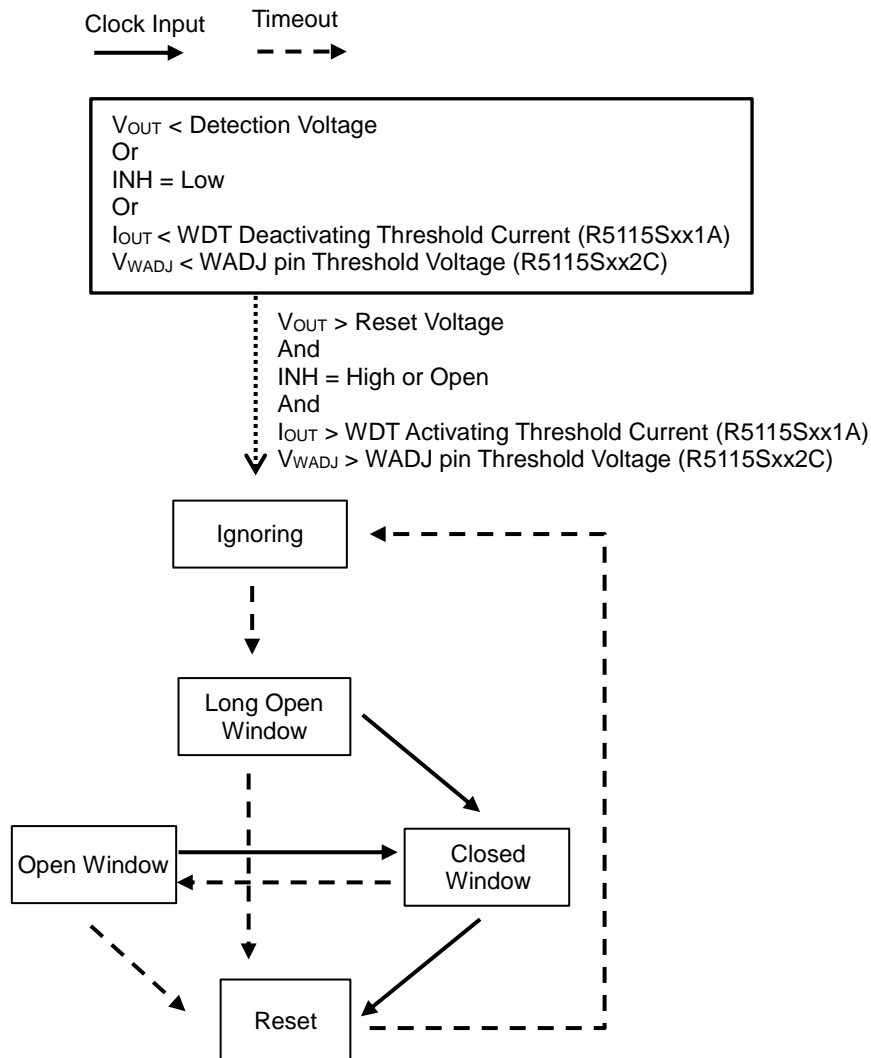

Watchdog Timer Setting

A watchdog timer (t_{OW} , t_{CW} , t_{OWL} , t_{IGN} , t_{WR}) can be set by using a capacitor connected to the TW pin. The relationship between capacitance and time are described as below:

$$t_{OW} (s) = 1.8 \times C(F) / (1.0 \times 10^{-6})$$

$$t_{CW} (s) = 1.8 \times C(F) / (4.0 \times 10^{-6})$$

$$t_{OWL} (s) = 1.8 \times C(F) / (0.225 \times 10^{-6})$$

$$t_{IGN} (s) = 1.8 \times C(F) / (1.0 \times 10^{-6})$$

$$t_{WR} (s) = 1.8 \times C(F) / (2.0 \times 10^{-6})$$

Allowable SCK Pulse Period

To prevent WDT of the R5115x from going into a reset state, the pulse period inputted to the SCK pin has to meet the following condition.

$$t_{cw} \text{ max} < \text{SCK Pulse Period} < (t_{cw} + t_{ow}) \text{ min}$$

The closed window time (t_{cw}) and the open window time (t_{ow}) in Electrical Characteristics may vary, and also the capacitor connected to the TW pin (C_{TW}) or the CD/TW pin (C_D/C_{TW}) may cause variations in t_{cw} or t_{ow} . Those variations are considered in the calculations below.

$$\text{Min. SCK Pulse Period (s)} = 0.53 \times \text{Max. } C_{TW} \text{ (F)} \times 10^6$$

$$\text{Max. SCK Pulse Period (s)} = 1.86 \times \text{Min. } C_{TW} \text{ (F)} \times 10^6$$

The graph below shows the relationship between the SCK pulse period and the external capacitance of C_{TW} . The pulse period inputted to the SCK pin has to be fit within the grayed-out area according to the capacitance of C_{TW} .

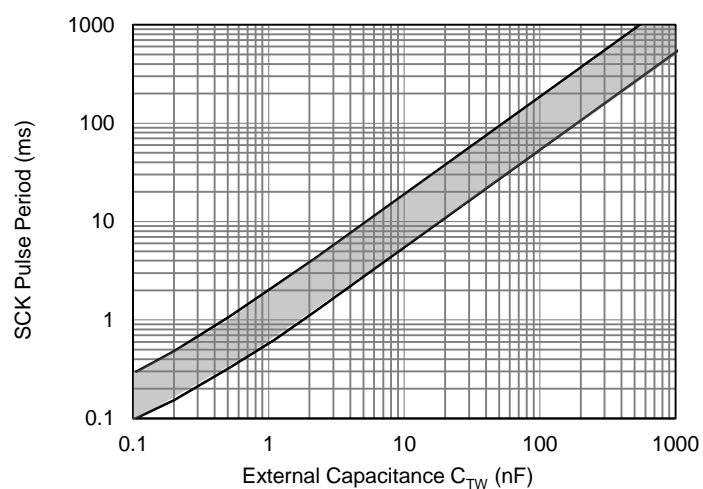

R5115x-Y

No. EY-409-190711

Standby Function

When the CE pin voltage (V_{CE}) is low, the R5115S goes into the standby mode. During the standby mode, the voltage regulator (VR) stops the output, the watchdog timer (WDT) stops the pulse monitoring and the voltage detector (VD) stops the voltage monitoring.

When V_{CE} is low, the outputs of WDT and VD will be as follows regardless of the output voltage (V_{OUT}).

R5115Sxx1A/ R5115Sxx1B: The RESETB pin voltage (V_{RESETB}) is fixed to low.

R5115Sxx2C: The DOUT pin voltage (V_{DOUT}) is low and the WDO pin voltage (V_{WDO}) is fixed to the pull-up voltage.

When the input voltage (V_{IN}) is less than 1.52 V with 5-V pull-up voltage and 100-k Ω pull-up resistance, V_{RESETB}/V_{DOUT} becomes indefinite, which means 0.1 V or more.

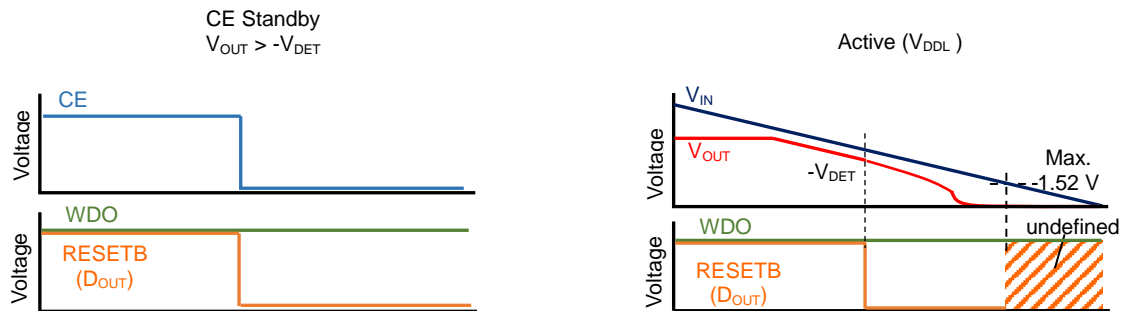

Voltage Regulator Voltage Setting

The voltage detector (VD) detects the output voltage drop of the voltage regulator (VR). If the VD reset voltage ($+V_{DET}$) is set to higher than the VR output voltage (V_{OUT}), VD continuously sends a reset signal even if VR output voltage (V_{OUT}) returns to the normal after detecting the output voltage drop of VR. To prevent this, the following conditions have to be met.

$$(\text{VR Set Output Voltage}) \times 0.985 - 30 \text{ mV} > (\text{VD Set Detection Voltage}) \times 1.018 \times 1.030$$

When using a device that is not meeting the above conditions, careful consideration must be given to the system operation before use.

Inhibit Function

When the INH pin voltage (V_{INH}) is low, the watchdog timer (WDT) stops monitoring a pulse. The WDO pin voltage (V_{WDO}) is fixed to high. The INH pin voltage (V_{INH}) is internally pulled up with a 400-k Ω (Typ.) resistor.

WADJ Function

The R5115Sxx1A/ R5115Sxx2C stops monitoring a pulse when the VR load current, which is a current flowing from the VOUT pin, is small. V_{WDO} is fixed to high. With the R5115Sxx1A, WDT stops monitoring a pulse when the load current is 1.0 mA (Typ.). With the R5115Sxx2C, the load current can be set by using a resistor (R2) connected to the WADJ pin. The relationships between the resistance (R2) and the load current for deactivating the pulse monitoring of WDT ($I_{OWDTDEACT}$), and the resistance (R2) and the load current for activating the pulse monitoring of WDT ($I_{OWDTACT}$) are described as below.

$$I_{OWDTACT} = V_{WADJ_TH} * \frac{I_{OUT}}{I_{WADJ}} (1) / R2$$

$$I_{OWDTDEACT} = V_{WADJ_TH} * \frac{I_{OUT}}{I_{WADJ}} (2) / R2$$

With the R5115Sxx1B, WDT monitors a pulse even when VR is in no-load state.

It is noted that WDT stops its operation regardless of load current of VR in the range of V_{IN} where the stable operation is not ensured owing to low V_{OUT} ; Dropout Voltage (V_{DIF}): $V_{IN} - V_{OUT}$ is < 1.2 V ($V_{SET} = 3.3$ V, $I_{OUT} = 100$ mA). The output voltage from RESETB pin of R5115Sxx1A depends on only VD and WDO pin is hold as "High."

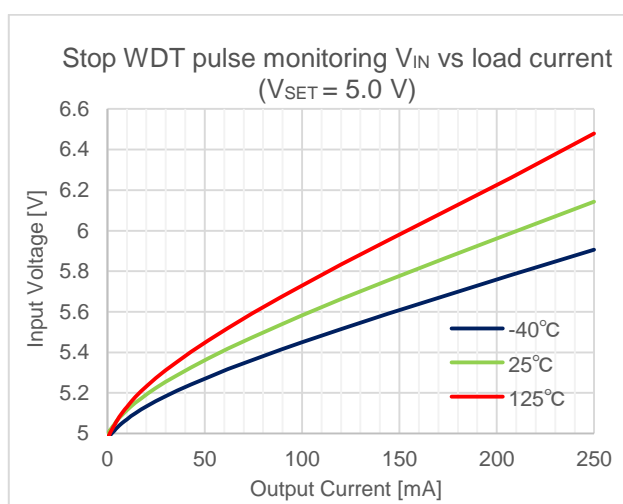
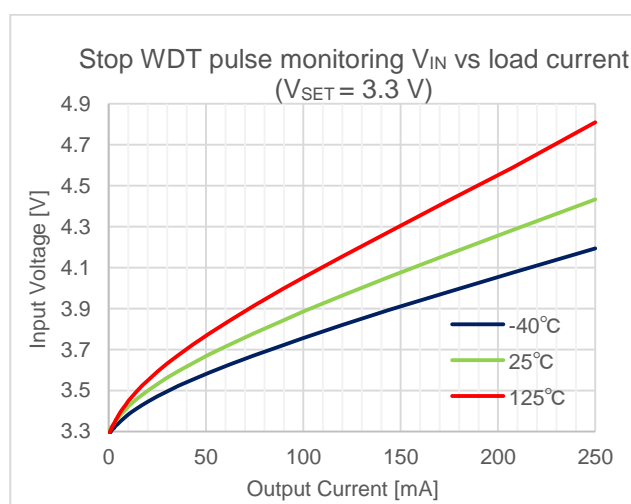

R5115x-Y

No. EY-409-190711

APPLICATION INFORMATION

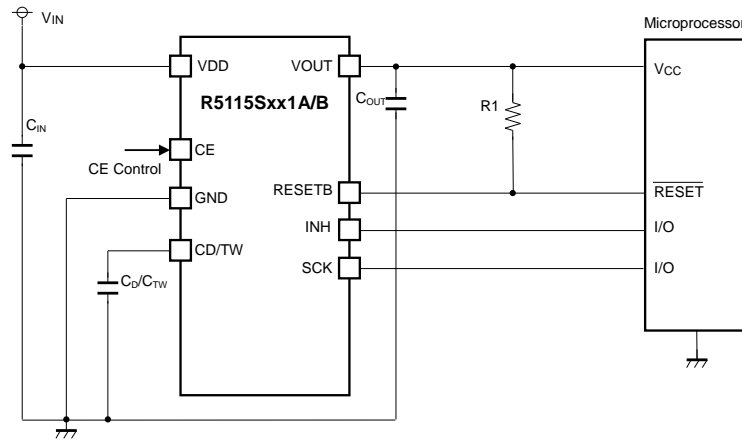

R5115Sxx1A/B Typical Application Circuit

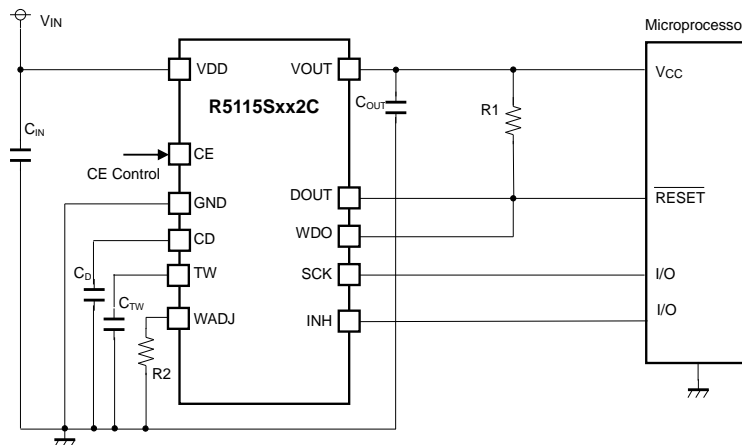

R5115Sxx2C Typical Application Circuit

External Components

Symbol	Description
C _{IN}	0.1 μF, Ceramic Capacitor
C _{OUT}	0.1 μF, Ceramic Capacitor
C _{TW}	Capacitor for setting a WDT Refer to WDT Setting at Theory of Operation.
C _D	Capacitor for setting reset delay time Refer to Delay Operation and Reset Delay Time at <i>THEORY OF OPERATION</i> .
R1	Set the value for R1 considering the output current when the Nch is on and the leakage current when the Nch is off described in the Electrical Characteristics.
R2	Set the value for R2 considering the WADJ pin current ration and the WADJ pin threshold voltage described in the Electrical Characteristics.

TECHNICAL NOTES

The performance of a power source circuit using this device is highly dependent on a peripheral circuit. A peripheral component or the device mounted on PCB should not exceed its rated voltage, rated current or rated power. When designing a peripheral circuit, please be fully aware of the following points.

Phase Compensation

A phase compensation is provided to secure stable operation even when the load current is varied. For this purpose, use a 0.1- μF or more output capacitor (C_{OUT}) with good frequency characteristics and proper ESR (Equivalent Series Resistance). In case of using a tantalum type capacitor with a large ESR, the output might become unstable. Evaluate your circuit including consideration of frequency characteristics. Connect a 0.1- μF or more input capacitor (C_{IN}) between the VDD and GND pins with shortest-distance wiring.

PCB Layout

Ensure that the VDD and GND lines are sufficiently robust. If their impedances are too high, noise pickup or unstable operation may result. Connect a 1.0 μF or more input capacitor (C_{IN}) between the VDD and GND pins with shortest-distance wiring. Also, connect an output capacitor (C_{OUT}) between the VOUT and GND pins with shortest-distance wiring.

Input Voltage Fluctuation Prohibited Area

The input voltage fluctuation in the following area may cause false detection or false detection release, so should not be allowed.

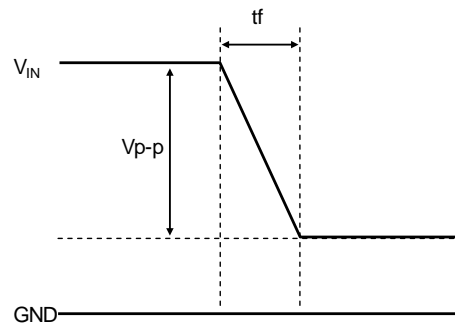
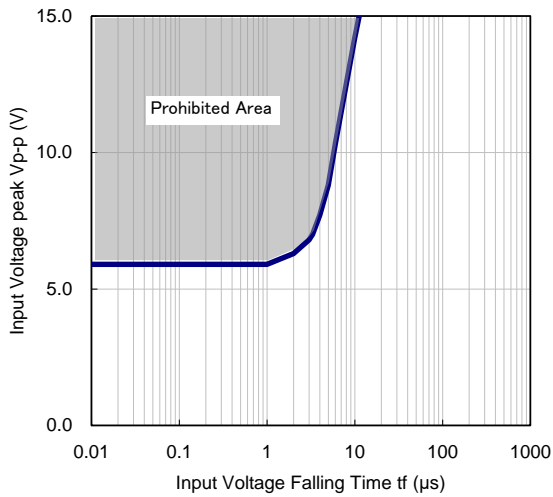
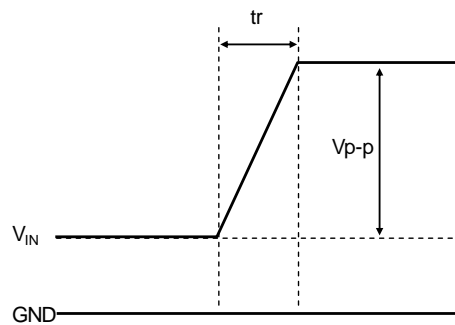
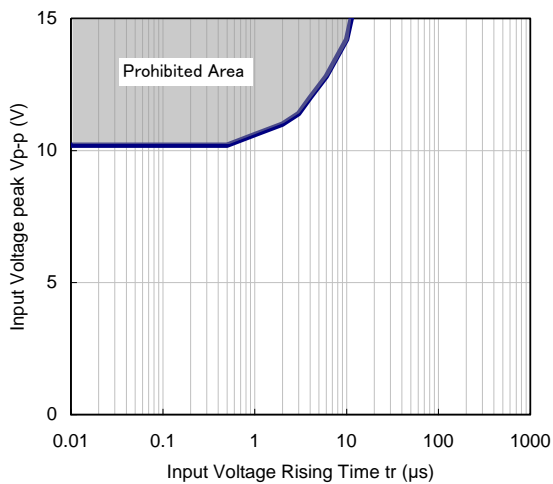
**Input Voltage Falling Fluctuation Prohibited Area****Input Voltage Rising Fluctuation Prohibited Area**

Typical Application Circuit with IC Chip Breakdown Prevention

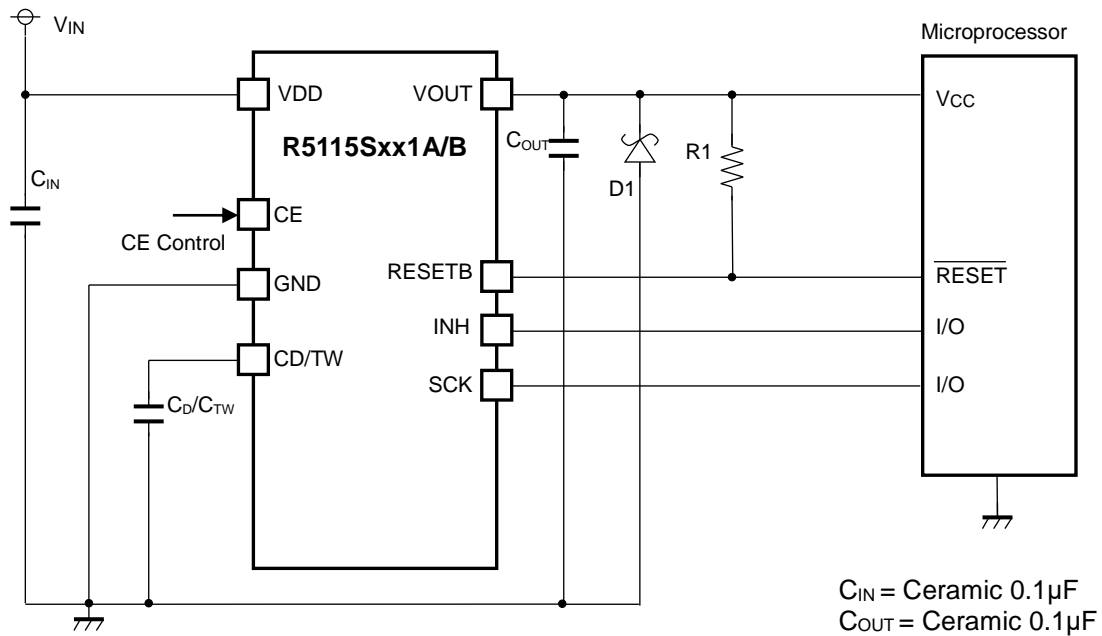

R5115Sxx1A/B Typical Application Circuit with IC Chip Breakdown Prevention

When a sudden surge of electrical current travels along the VOUT pin and GND due to a short-circuit, electrical resonance of a circuit involving an output capacitor (C_{OUT}) and a short circuit inductor generates a negative voltage and may damage the device or the load devices. Connecting a schottky diode (D1) between the VOUT pin and GND has the effect of preventing damage to them.

TYPICAL CHARACTERISTICS

Note: Typical Characteristics are intended to be used as reference data; they are not guaranteed.

1) Supply Current vs. Input Voltage

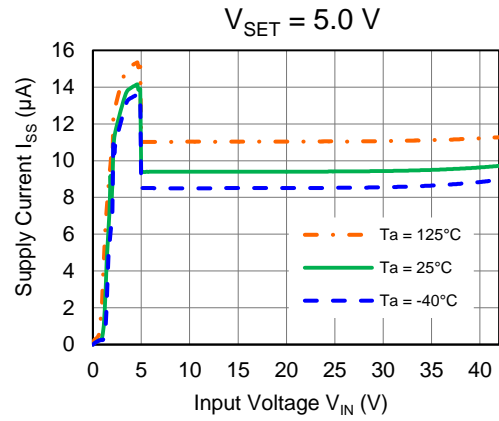
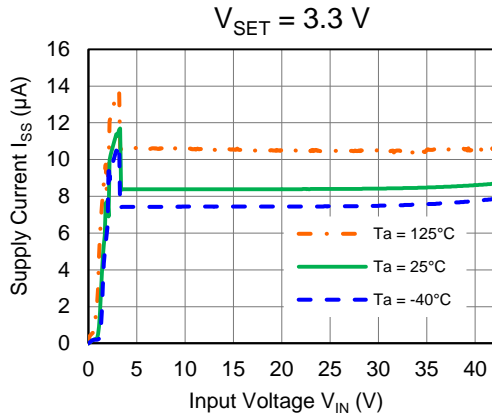

2) GND Pin Current vs. Output Current ($T_a = 25^\circ\text{C}$)

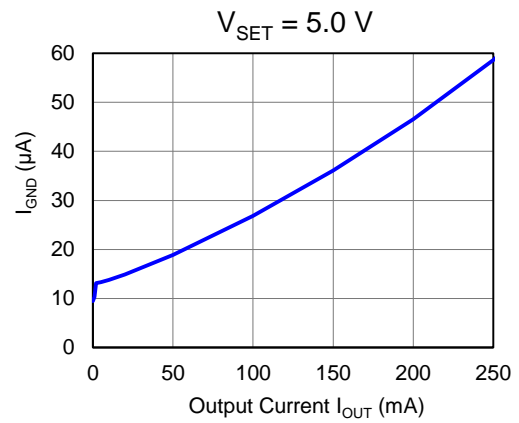
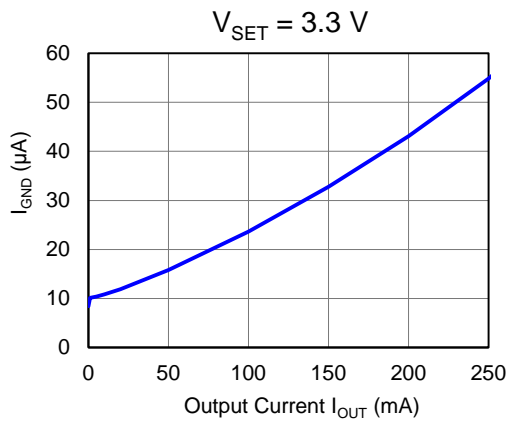

3) Output Voltage vs. Output Current ($T_a = 25^\circ\text{C}$)

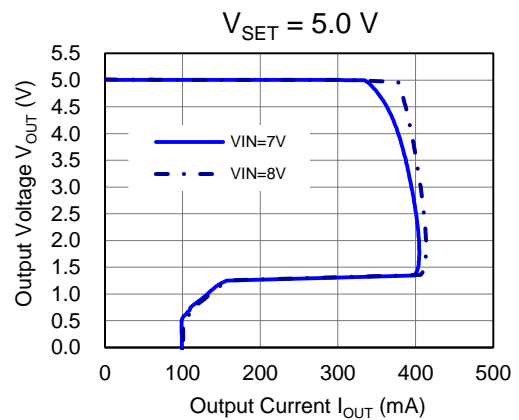
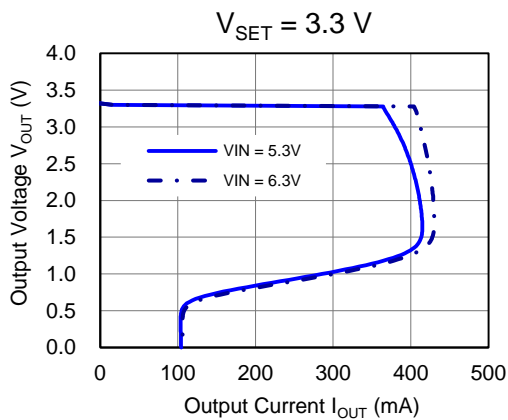

4) Output Voltage vs. Input Voltage (Ta = 25°C)

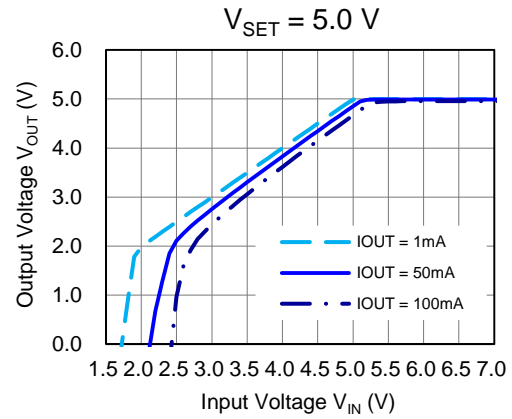
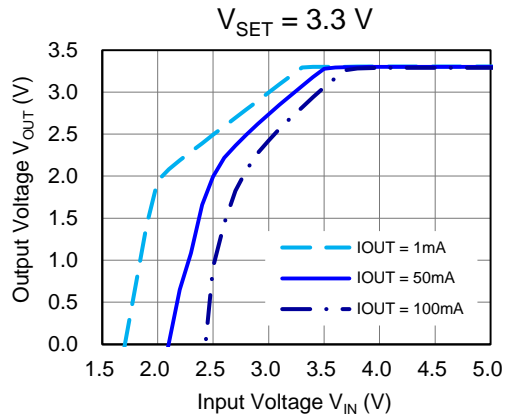

5) Output Voltage vs. Ambient Temperature (VIN = 14 V, IOUT = 1 mA)

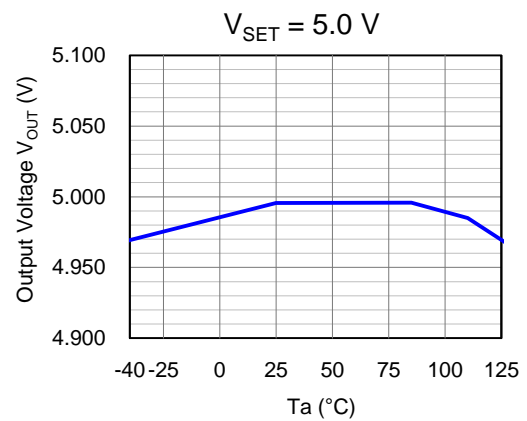
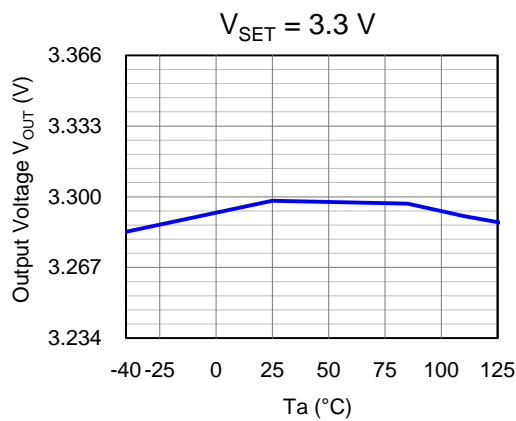

6) Dropout Voltage vs. Output Current

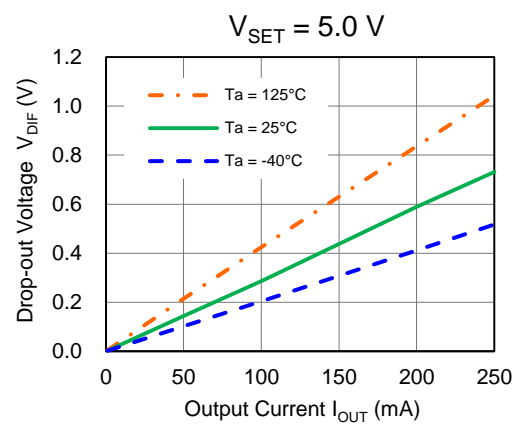
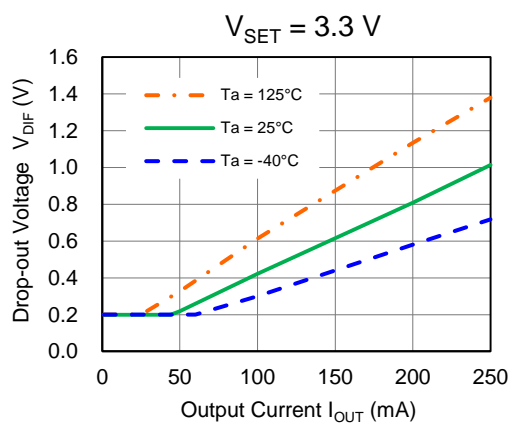

7) Ripple Rejection vs. Frequency ($T_a = 25^\circ\text{C}$, Ripple = 0.2 Vpp)

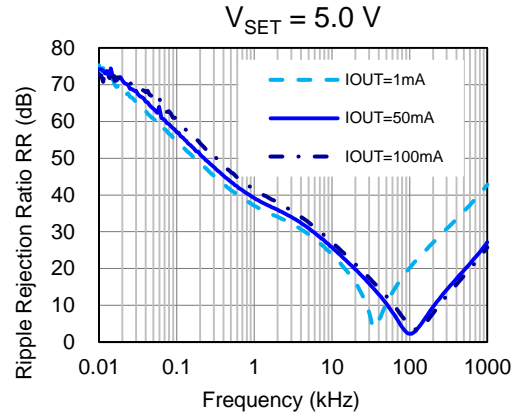
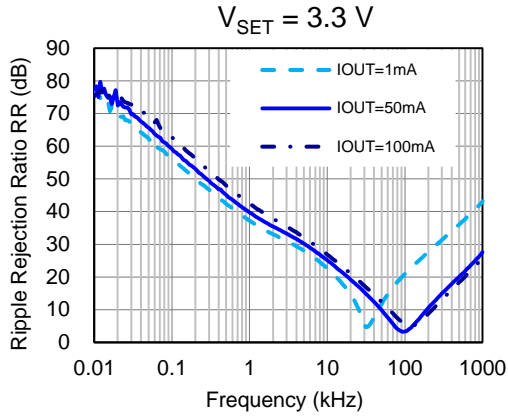

8) Input Transient Response ($T_a = 25^\circ\text{C}$)

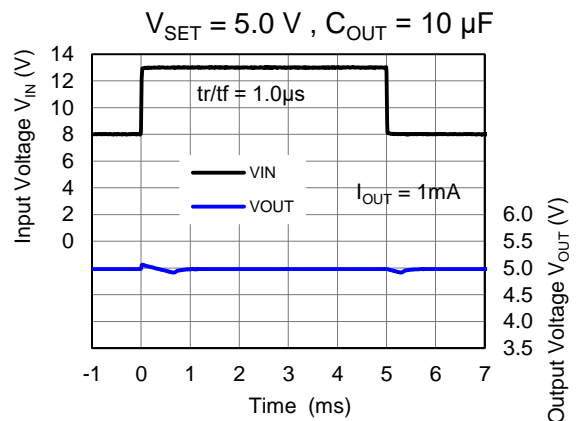
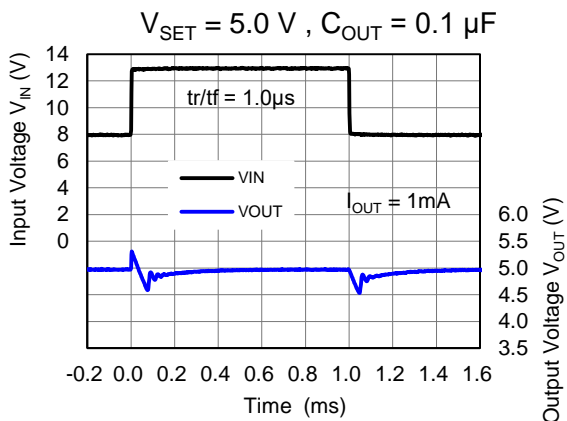
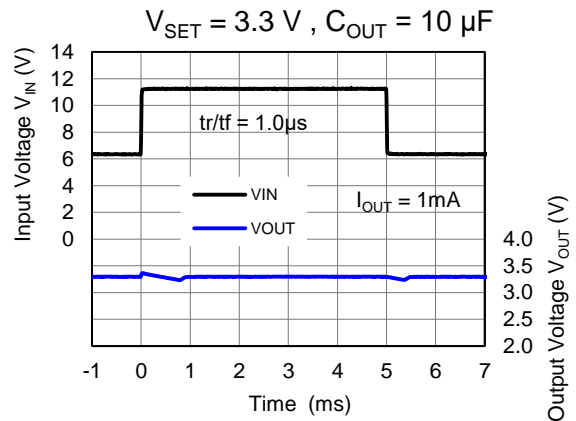
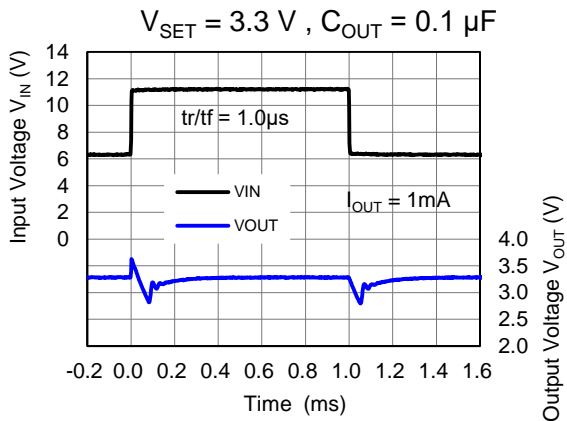

9) Load Transient Response ($T_a = 25^\circ\text{C}$)

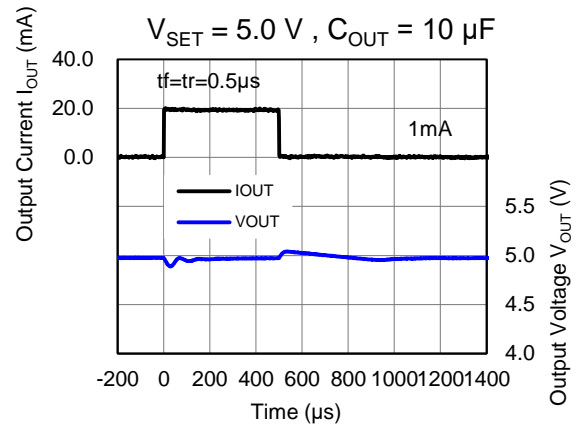
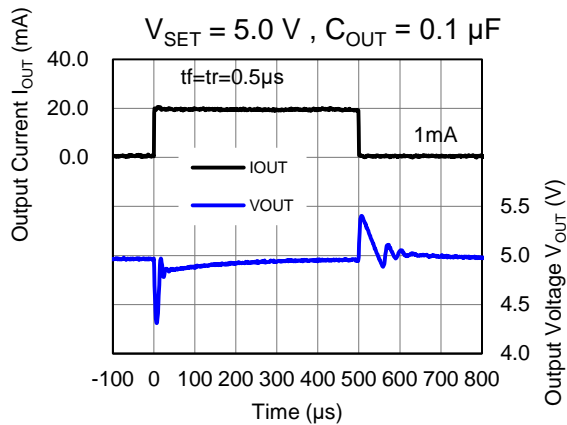
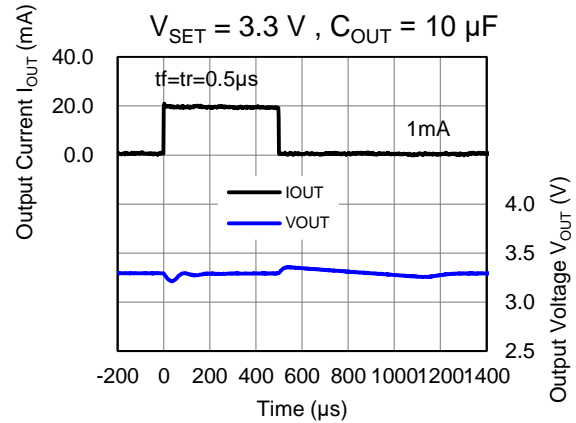
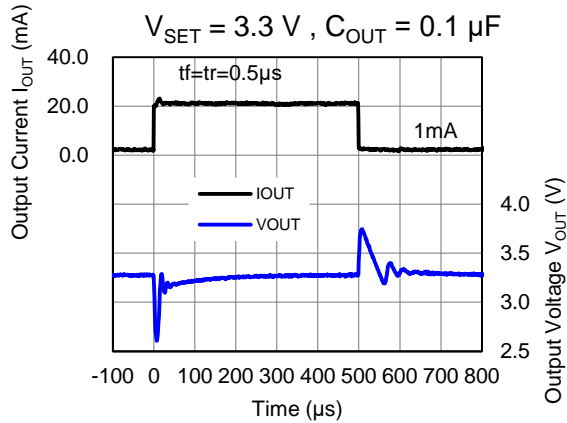

10) CE Transient Response ($T_a = 25^\circ\text{C}, V_{IN} = 14 \text{ V}, I_{OUT} = 1 \text{ mA}, C_{OUT} = 0.1 \mu\text{F}/10 \mu\text{F}$)

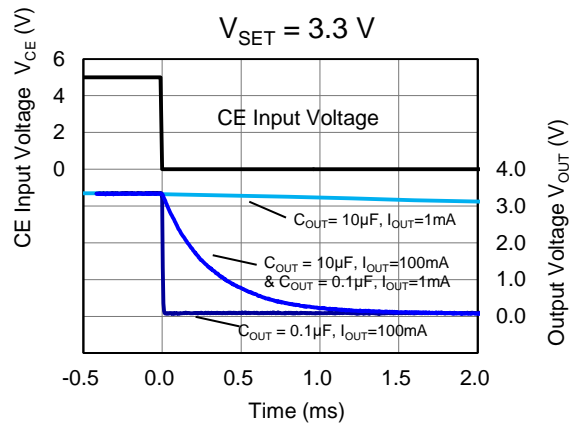
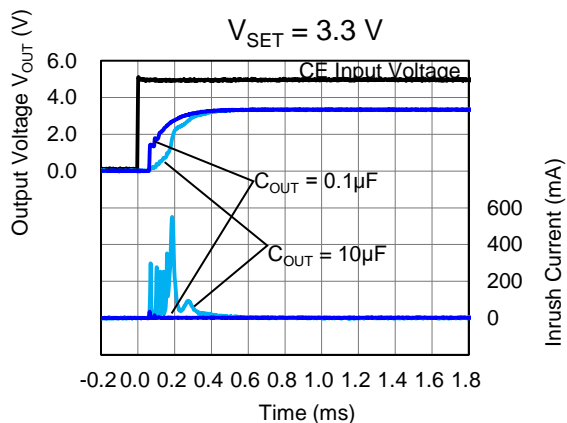

R5115x-Y

No. EY-409-190711

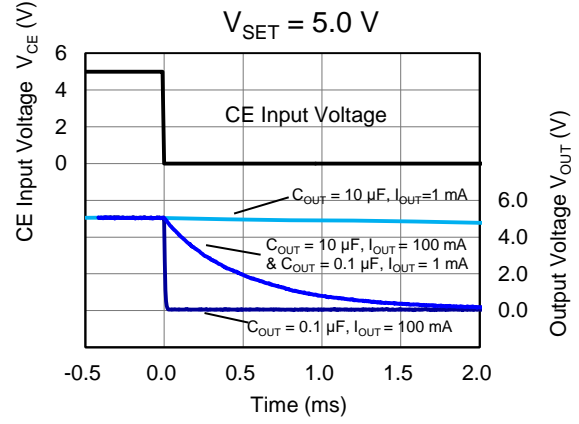
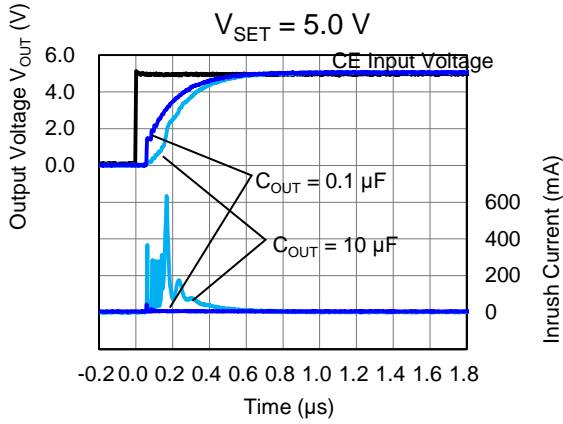

11) Load Dump ($T_a = 25^\circ\text{C}$)

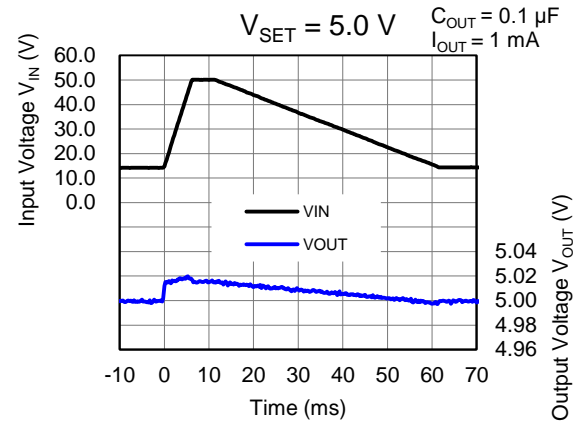
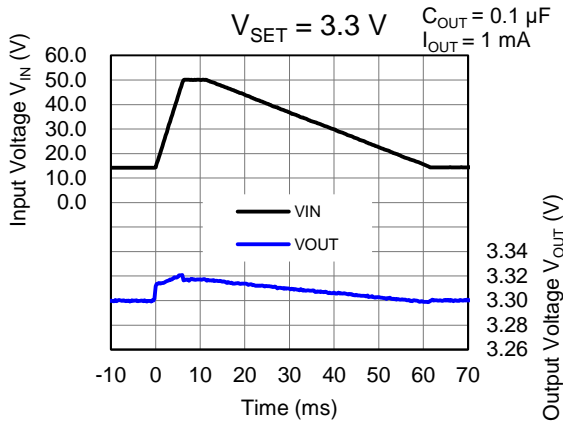

12) Cranking ($T_a = 25^\circ\text{C}$)

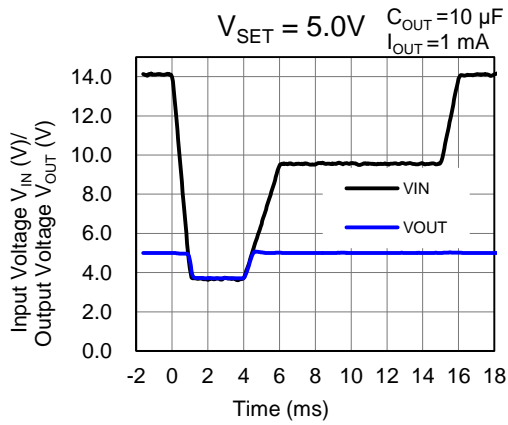

13) Detection Voltage vs. Ambient Temperature

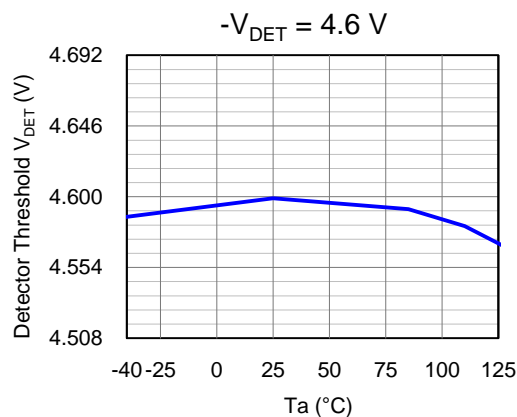
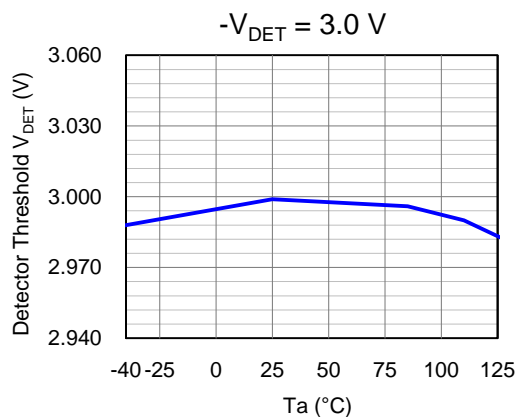

14) Release Delay Time vs. Ambient Temperature 15) Detection Delay Time vs. Ambient Temperature

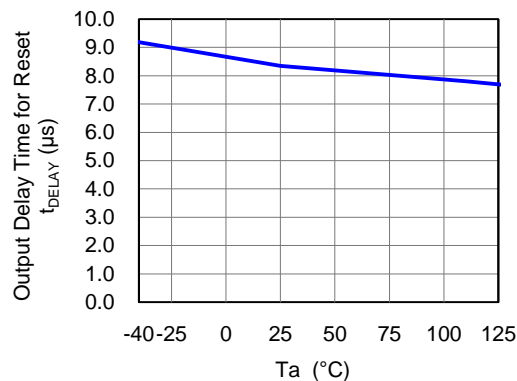
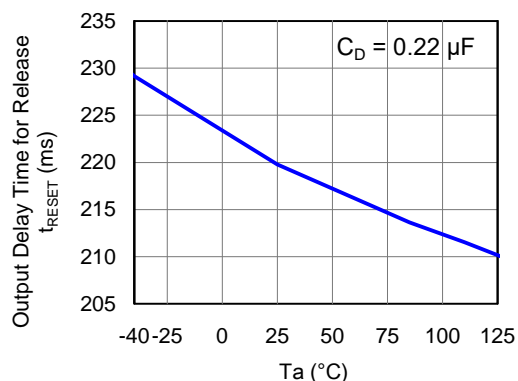

16) Release Delay and Detection Delay Time vs. CD Pin External Capacitance

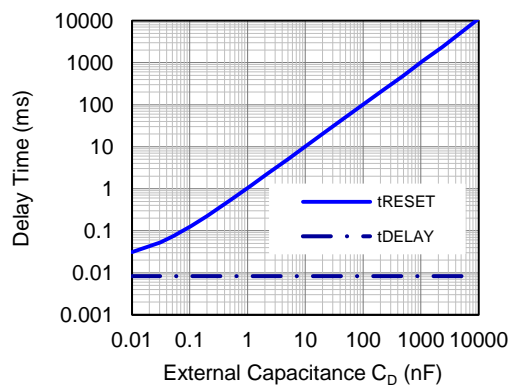

17) DOUT Pin Voltage vs. Input Voltage (DOUT pulled-up to 5 V with 100 kΩ)

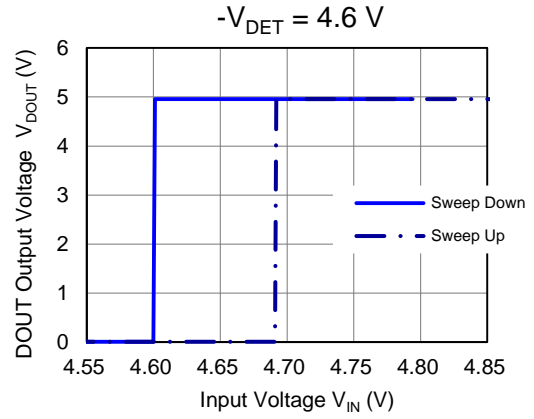
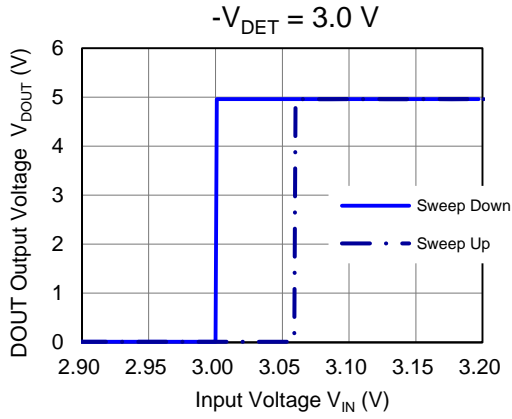

18) RESETB/DOUT Driver Output Current vs. V_{DS} 19) RESETB/DOUT Driver Output Current vs. Input Voltage

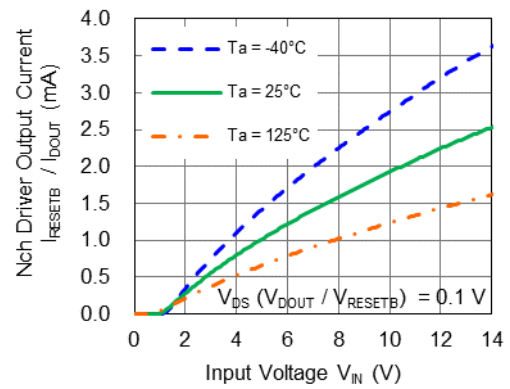
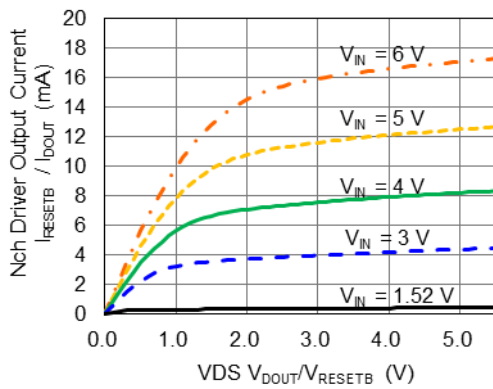

20) Open Window Time/Pulse Ignoring Time vs. Ambient Temperature 21) Closed Window Time vs. Ambient Temperature

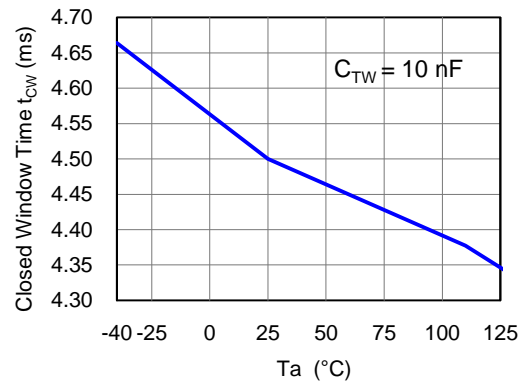
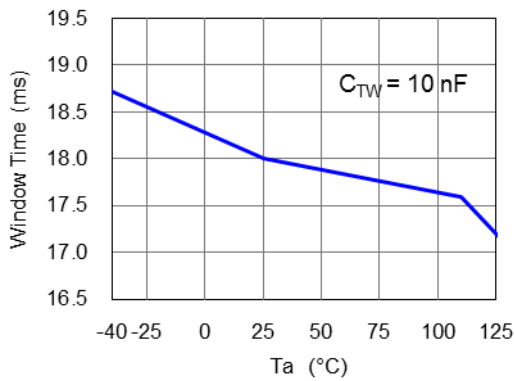

22) Reset Time vs. Ambient Temperature

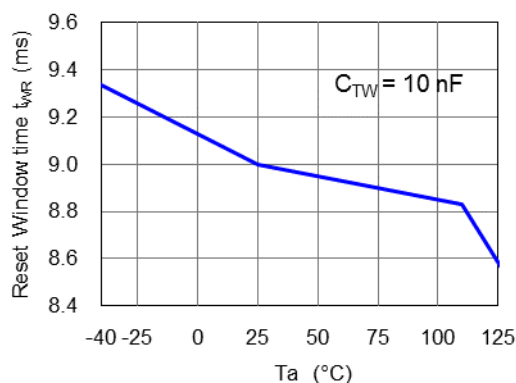

23) Long Open Window Time vs. Ambient Temperature

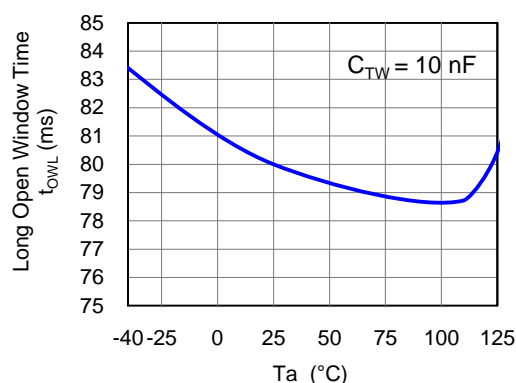

24) WDT t_{WD} / t_{OW} / t_{CW} / t_{IGN} / t_{OWL} / t_{RST} vs. TW Pin External Capacitance

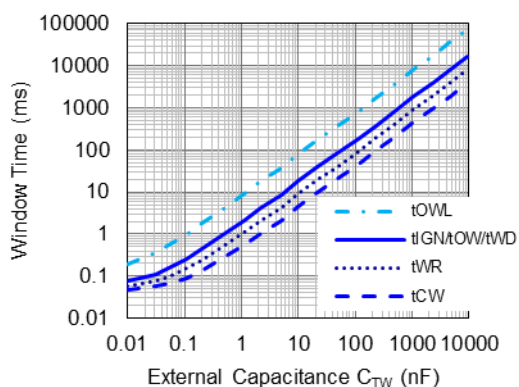

25) WDT Monitoring Threshold Load Current vs. Ambient Temperature

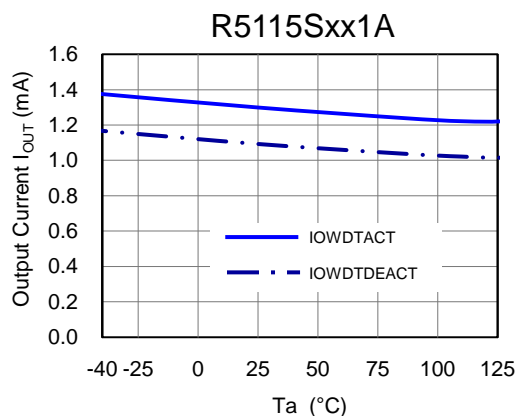

26) WADJ Pin Current Ratio vs. Ambient Temperature

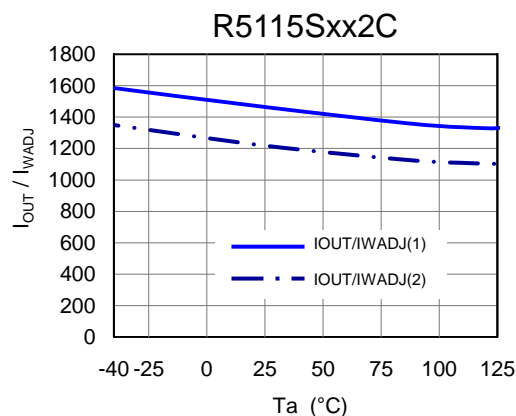

27) WDO Driver Output Current vs. V_{DS}

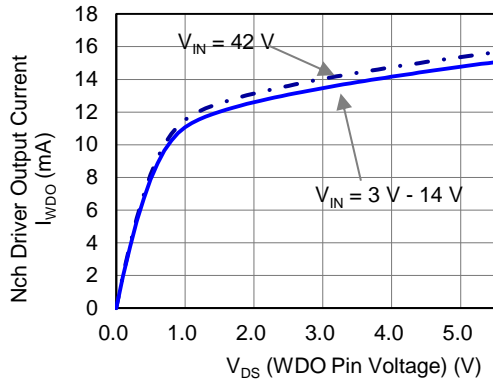

28) WDO Driver Output Current vs. Input Voltage

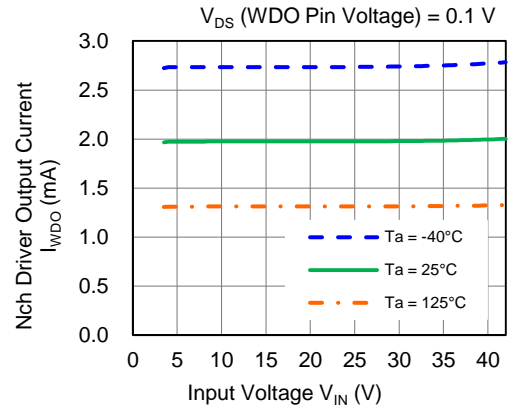

The power dissipation of the package is dependent on PCB material, layout, and environmental conditions. The following measurement conditions are based on JEDEC STD. 51-7.

Measurement Conditions

Item	Measurement Conditions
Environment	Mounting on Board (Wind Velocity = 0 m/s)
Board Material	Glass Cloth Epoxy Plastic (Four-Layer Board)
Board Dimensions	76.2 mm × 114.3 mm × 0.8 mm
Copper Ratio	Outer Layer (First Layer): Less than 95% of 50 mm Square Inner Layers (Second and Third Layers): Approx. 100% of 50 mm Square Outer Layer (Fourth Layer): Approx. 100% of 50 mm Square
Through-holes	φ 0.3 mm × 21 pcs

Measurement Result

(Ta = 25°C, Tjmax = 150°C)

Item	Measurement Result
Power Dissipation	3600 mW
Thermal Resistance (θ_{ja})	$\theta_{ja} = 34.5^{\circ}\text{C/W}$
Thermal Characterization Parameter (ψ_{jt})	$\psi_{jt} = 10^{\circ}\text{C/W}$

θ_{ja} : Junction-to-Ambient Thermal Resistance

ψ_{jt} : Junction-to-Top Thermal Characterization Parameter

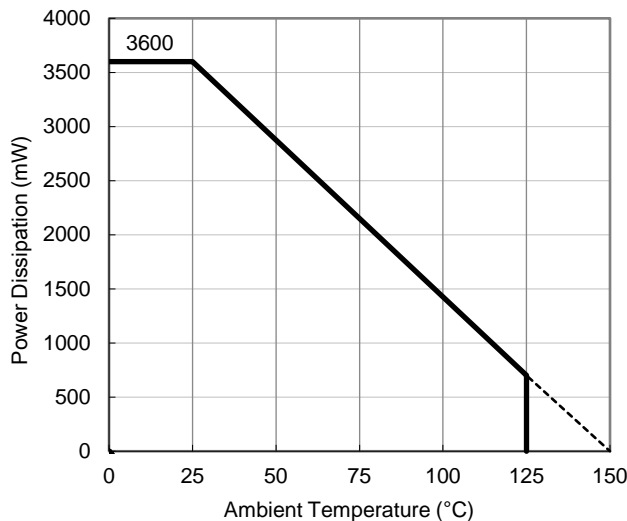

Power Dissipation vs. Ambient Temperature

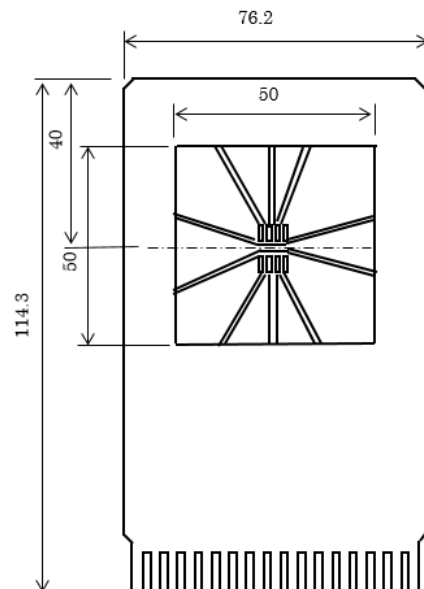

Measurement Board Pattern

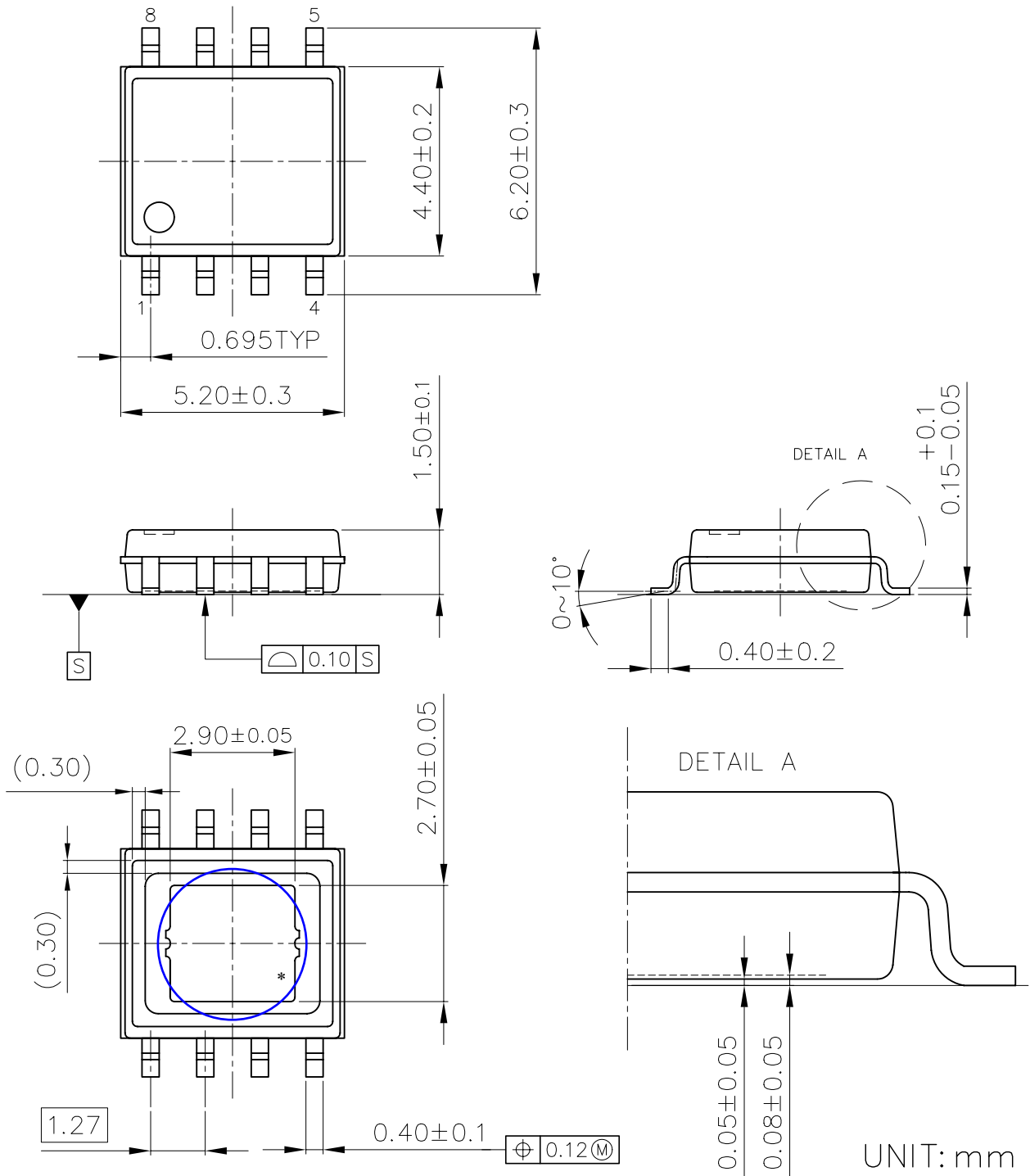

HSOP-8E Package Dimensions

* The tab on the bottom of the package shown by blue circle is substrate potential (GND). It is recommended that this tab be connected to the ground plane on the board but it is possible to leave the tab floating.

The power dissipation of the package is dependent on PCB material, layout, and environmental conditions. The following measurement conditions are based on JEDEC STD. 51-7.

Measurement Conditions

Item	Measurement Conditions
Environment	Mounting on Board (Wind Velocity = 0 m/s)
Board Material	Glass Cloth Epoxy Plastic (Four-Layer Board)
Board Dimensions	76.2 mm × 114.3 mm × 0.8 mm
Copper Ratio	Outer Layer (First Layer): Less than 95% of 50 mm Square Inner Layers (Second and Third Layers): Approx. 100% of 50 mm Square Outer Layer (Fourth Layer): Approx. 100% of 50 mm Square
Through-holes	φ 0.3 mm × 21 pcs

Measurement Result

(Ta = 25°C, Tjmax = 150°C)

Item	Measurement Result
Power Dissipation	3900 mW
Thermal Resistance (θja)	θja = 32°C/W
Thermal Characterization Parameter (ψjt)	ψjt = 8°C/W

θja: Junction-to-Ambient Thermal Resistance

ψjt: Junction-to-Top Thermal Characterization Parameter

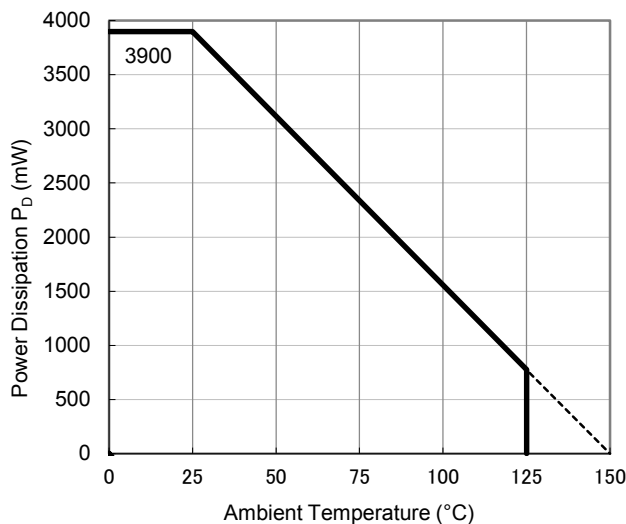

Power Dissipation vs. Ambient Temperature

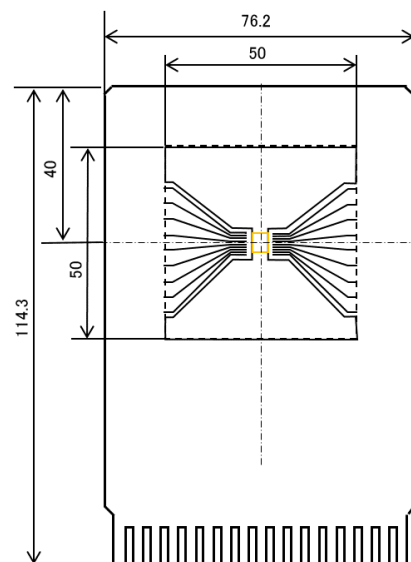

Measurement Board Pattern

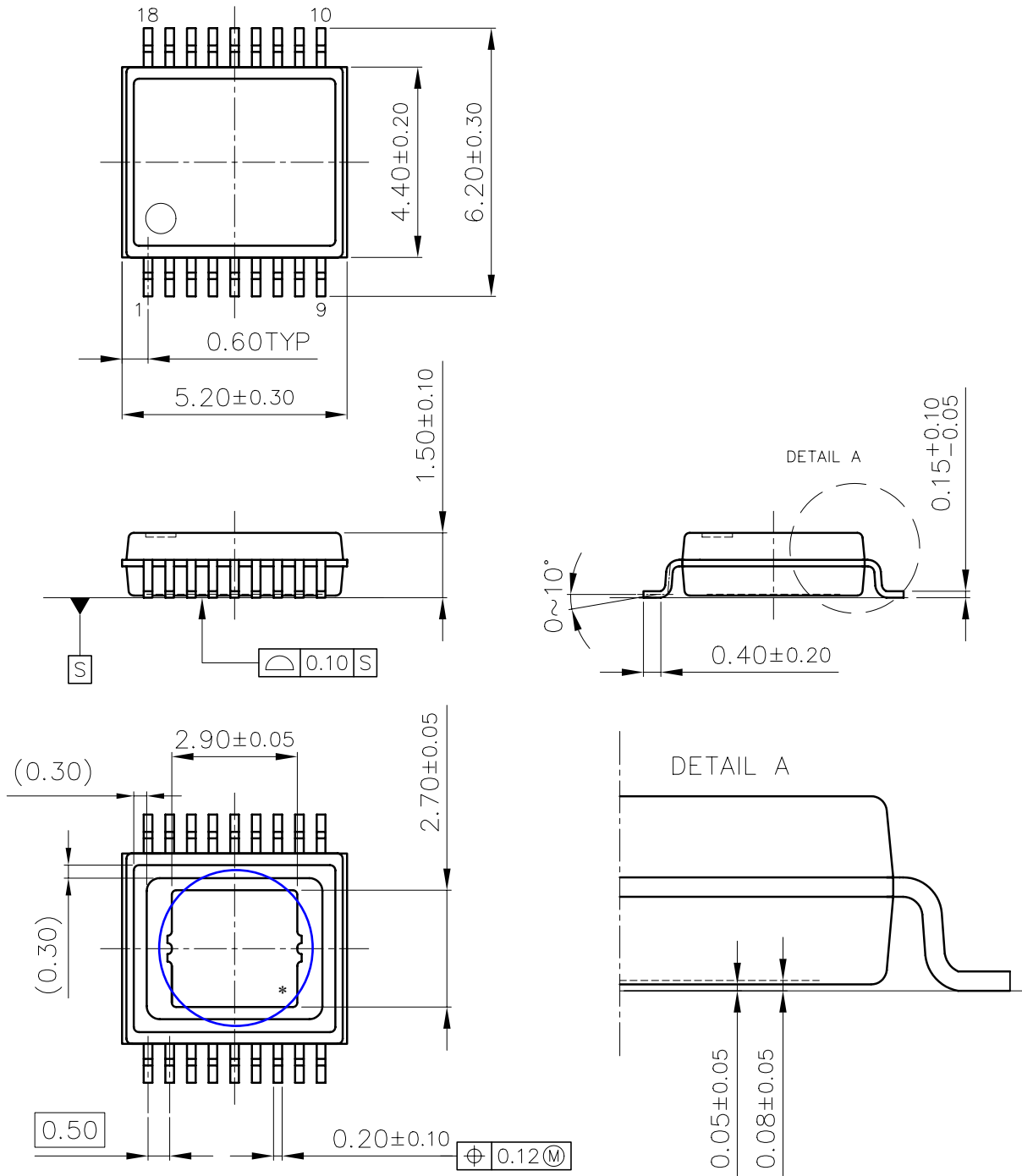

UNIT: mm

HSOP-18 Package Dimensions

* The tab on the bottom of the package shown by blue circle is substrate potential (GND). It is recommended that this tab be connected to the ground plane on the board but it is possible to leave the tab floating.



1. The products and the product specifications described in this document are subject to change or discontinuation of production without notice for reasons such as improvement. Therefore, before deciding to use the products, please refer to Ricoh sales representatives for the latest information thereon.
2. The materials in this document may not be copied or otherwise reproduced in whole or in part without prior written consent of Ricoh.
3. Please be sure to take any necessary formalities under relevant laws or regulations before exporting or otherwise taking out of your country the products or the technical information described herein.
4. The technical information described in this document shows typical characteristics of and example application circuits for the products. The release of such information is not to be construed as a warranty of or a grant of license under Ricoh's or any third party's intellectual property rights or any other rights.
5. The products listed in this document are intended and designed for use as general electronic components in standard applications (office equipment, telecommunication equipment, measuring instruments, consumer electronic products, amusement equipment etc.). Those customers intending to use a product in an application requiring extreme quality and reliability, for example, in a highly specific application where the failure or misoperation of the product could result in human injury or death (aircraft, spacevehicle, nuclear reactor control system, traffic control system, automotive and transportation equipment, combustion equipment, safety devices, life support system etc.) should first contact us.
6. We are making our continuous effort to improve the quality and reliability of our products, but semiconductor products are likely to fail with certain probability. In order to prevent any injury to persons or damages to property resulting from such failure, customers should be careful enough to incorporate safety measures in their design, such as redundancy feature, fire containment feature and fail-safe feature. We do not assume any liability or responsibility for any loss or damage arising from misuse or inappropriate use of the products.
7. Anti-radiation design is not implemented in the products described in this document.
8. The X-ray exposure can influence functions and characteristics of the products. Confirm the product functions and characteristics in the evaluation stage.
9. WLCSP products should be used in light shielded environments. The light exposure can influence functions and characteristics of the products under operation or storage.
10. There can be variation in the marking when different AOI (Automated Optical Inspection) equipment is used. In the case of recognizing the marking characteristic with AOI, please contact Ricoh sales or our distributor before attempting to use AOI.
11. Please contact Ricoh sales representatives should you have any questions or comments concerning the products or the technical information.



Ricoh is committed to reducing the environmental loading materials in electrical devices with a view to contributing to the protection of human health and the environment.

Ricoh has been providing RoHS compliant products since April 1, 2006 and Halogen-free products since April 1, 2012.

RICOH RICOH ELECTRONIC DEVICES CO., LTD.

<https://www.e-devices.ricoh.co.jp/en/>

Sales & Support Offices

Ricoh Electronic Devices Co., Ltd.

Shin-Yokohama Office (International Sales)

2-3, Shin-Yokohama 3-chome, Kohoku-ku, Yokohama-shi, Kanagawa, 222-8530, Japan
Phone: +81-50-3814-7687 Fax: +81-45-474-0074

Ricoh Americas Holdings, Inc.

675 Campbell Technology Parkway, Suite 200 Campbell, CA 95008, U.S.A.
Phone: +1-408-610-3105

Ricoh Europe (Netherlands) B.V.

Semiconductor Support Centre

Prof. W.H. Keesomlaan 1, 1183 DJ Amstelveen, The Netherlands
Phone: +31-20-5474-309

Ricoh International B.V. - German Branch

Semiconductor Sales and Support Centre

Oberrather Strasse 6, 40472 Düsseldorf, Germany
Phone: +49-211-6546-0

Ricoh Electronic Devices Korea Co., Ltd.

3F, Haesung Bldg, 504, Teheran-ro, Gangnam-gu, Seoul, 135-725, Korea
Phone: +82-2-2135-5700 Fax: +82-2-2051-5713

Ricoh Electronic Devices Shanghai Co., Ltd.

Room 403, No.2 Building, No.690 Bibo Road, Pu Dong New District, Shanghai 201203,
People's Republic of China
Phone: +86-21-5027-3200 Fax: +86-21-5027-3299

Ricoh Electronic Devices Shanghai Co., Ltd.

Shenzhen Branch

1205, Block D (Jinlong Building), Kingkey 100, Hongbao Road, Luohu District,
Shenzhen, China
Phone: +86-755-8348-7600 Ext 225

Ricoh Electronic Devices Co., Ltd.

Taipei office

Room 109, 10F-1, No.51, Hengyang Rd., Taipei City, Taiwan
Phone: +886-2-2313-1621/1622 Fax: +886-2-2313-1623

Mouser Electronics

Authorized Distributor

Click to View Pricing, Inventory, Delivery & Lifecycle Information:

[Rico Electronics:](#)

[R5115S012C-E2-YE](#) [R5115S011A-E2-YE](#) [R5115S111A-E2-YE](#)

Компания «Океан Электроники» предлагает заключение долгосрочных отношений при поставках импортных электронных компонентов на взаимовыгодных условиях!

Наши преимущества:

- Поставка оригинальных импортных электронных компонентов напрямую с производств Америки, Европы и Азии, а так же с крупнейших складов мира;
- Широкая линейка поставок активных и пассивных импортных электронных компонентов (более 30 млн. наименований);
- Поставка сложных, дефицитных, либо снятых с производства позиций;
- Оперативные сроки поставки под заказ (от 5 рабочих дней);
- Экспресс доставка в любую точку России;
- Помощь Конструкторского Отдела и консультации квалифицированных инженеров;
- Техническая поддержка проекта, помощь в подборе аналогов, поставка прототипов;
- Поставка электронных компонентов под контролем ВП;
- Система менеджмента качества сертифицирована по Международному стандарту ISO 9001;
- При необходимости вся продукция военного и аэрокосмического назначения проходит испытания и сертификацию в лаборатории (по согласованию с заказчиком);
- Поставка специализированных компонентов военного и аэрокосмического уровня качества (Xilinx, Altera, Analog Devices, Intersil, Interpoint, Microsemi, Actel, Aeroflex, Peregrine, VPT, Syfer, Eurofarad, Texas Instruments, MS Kennedy, Miteq, Cobham, E2V, MA-COM, Hittite, Mini-Circuits, General Dynamics и др.);

Компания «Океан Электроники» является официальным дистрибьютором и эксклюзивным представителем в России одного из крупнейших производителей разъемов военного и аэрокосмического назначения «JONHON», а так же официальным дистрибьютором и эксклюзивным представителем в России производителя высокотехнологичных и надежных решений для передачи СВЧ сигналов «FORSTAR».



JONHON

«JONHON» (основан в 1970 г.)

Разъемы специального, военного и аэрокосмического назначения:

(Применяются в военной, авиационной, аэрокосмической, морской, железнодорожной, горно- и нефтедобывающей отраслях промышленности)

«FORSTAR» (основан в 1998 г.)

ВЧ соединители, коаксиальные кабели, кабельные сборки и микроволновые компоненты:

(Применяются в телекоммуникациях гражданского и специального назначения, в средствах связи, РЛС, а так же военной, авиационной и аэрокосмической отраслях промышленности).



Телефон: 8 (812) 309-75-97 (многоканальный)

Факс: 8 (812) 320-03-32

Электронная почта: ocean@oceanchips.ru

Web: <http://oceanchips.ru/>

Адрес: 198099, г. Санкт-Петербург, ул. Калинина, д. 2, корп. 4, лит. А