

I/O module - AXL F DO16 FLK 1H - 2701813

Please be informed that the data shown in this PDF Document is generated from our Online Catalog. Please find the complete data in the user's documentation. Our General Terms of Use for Downloads are valid (<http://phoenixcontact.com/download>)



Axioline F digital output module, 16 outputs, 24 V DC, 500 mA, FLK20 connection for system cabling (including bus base module and connectors)

Product Description

The module is designed for use within an Axioline F station. It is used to output digital signals. You can connect PLC relays from the INTERFACE product range quickly and conveniently using the FLK connection. This means that you can also use this output module in applications which require relays, e.g., to switch high voltages or currents.

Product Features

- 16 digital outputs
- 24 V DC, 500 mA
-
- Minimum update time of < 100 μ s
- Device rating plate stored
- Diagnostic and status indicators



Key Commercial Data

Packing unit	1 pc
Weight per Piece (excluding packing)	200.0 g
Custom tariff number	85389091
Country of origin	Germany

Technical data

Note

Utilization restriction	EMC: class A product, see manufacturer's declaration in the download area
-------------------------	---

Dimensions

Width	35 mm
Height	126.1 mm

I/O module - AXL F DO16 FLK 1H - 2701813

Technical data

Dimensions

Depth	54 mm
Note on dimensions	The depth is valid when a TH 35-7.5 DIN rail is used (according to EN 60715).

Ambient conditions

Ambient temperature (operation)	-25 °C ... 60 °C
Ambient temperature (storage/transport)	-40 °C ... 85 °C
Permissible humidity (operation)	5 % ... 95 % (non-condensing)
Permissible humidity (storage/transport)	5 % ... 95 % (non-condensing)
Air pressure (operation)	70 kPa ... 106 kPa (up to 3000 m above sea level)
Air pressure (storage/transport)	70 kPa ... 106 kPa (up to 3000 m above sea level)
Degree of protection	IP20

Connection data

Designation	Axioline F connector
Connection method	Push-in connection
Note on connection method	Please observe the information provided on conductor cross sections in the "Axioline F: system and installation" user manual.
Conductor cross section solid min.	0.2 mm ²
Conductor cross section solid max.	1.5 mm ²
Conductor cross section flexible min.	0.2 mm ²
Conductor cross section flexible max.	1.5 mm ²
Conductor cross section AWG min.	24
Conductor cross section AWG max.	16
Stripping length	8 mm

General

Net weight	108 g
Note on weight specifications	with connector and bus base module
Mounting type	DIN rail
Protection class	III, IEC 61140, EN 61140, VDE 0140-1
Test section	5 V communications power (logic), 24 V supply (I/O) 500 V AC 50 Hz 1 min
	5 V supply (logic)/functional earth ground 500 V AC 50 Hz 1 min
	24 V supply (I/O) / functional earth ground 500 V AC 50 Hz 1 min
Conformance with EMC directives	Noise immunity test in accordance with EN 61000-6-2 Electrostatic discharge (ESD) EN 61000-4-2/IEC 61000-4-2 Criterion B; 6 kV contact discharge, 8 kV air discharge
	Noise immunity test in accordance with EN 61000-6-2 Electromagnetic fields EN 61000-4-3/IEC 61000-4-3 Criterion A; Field intensity: 10 V/m
	Noise immunity test in accordance with EN 61000-6-2 Fast transients (burst) EN 61000-4-4/IEC 61000-4-4 Criterion B, 2 kV

I/O module - AXL F DO16 FLK 1H - 2701813

Technical data

General

	Noise immunity test in accordance with EN 61000-6-2 Transient surge voltage (surge) EN 61000-4-5/IEC 61000-4-5 Criterion B; DC supply lines: ± 0.5 kV/ ± 0.5 kV (symmetrical/asymmetrical)
	Noise immunity test in accordance with EN 61000-6-2 Conducted interference EN 61000-4-6/IEC 61000-4-6 Criterion A; Test voltage 10 V
	Noise emission test according to EN 61000-6-3 Radio interference properties EN 55022 Class B
Mechanical tests	Vibration resistance in acc. with EN 60068-2-6/IEC 60068-2-6 5g
	Shock in acc. with EN 60068-2-27/IEC 60068-2-27 30g, 11 ms period, half-sine shock pulse
	Continuous shock according to EN 60068-2-27/IEC 60068-2-27 10g
Diagnostics messages	Short-circuit / overload of the digital outputs Yes

Interfaces

Designation	Axioline F local bus
Connection method	Bus base module
Transmission speed	100 MBit/s

Axioline potentials

Communications power U_{Bus}	5 V DC (via bus base module)
Current consumption from U_{Bus}	max. 120 mA
Supply of digital output modules U_O	24 V DC
Current consumption from U_O	8 A (external fuse)

Digital outputs

Output name	Digital outputs
Connection method	FLK20 pin strip
	FLK connector (20-pos.)
Number of outputs	16
Protective circuit	Short-circuit protection, overload protection of the outputs Electronic
Output voltage	24 V
Nominal output voltage	24 V DC
Maximum output current per channel	500 mA
Maximum output current per module	8 A (external fuse)
Nominal load, inductive	max. 12 VA (1.2 H; 48 Ω ; with nominal voltage)
Nominal load, lamp	max. 12 W (at nominal voltage)
Nominal load, ohmic	max. 12 W (48 Ω ; with nominal voltage)

I/O module - AXL F DO16 FLK 1H - 2701813

Classifications

eCl@ss

eCl@ss 4.0	27240404
eCl@ss 4.1	27240404
eCl@ss 5.0	27242204
eCl@ss 5.1	27242604
eCl@ss 6.0	27242604
eCl@ss 7.0	27242604
eCl@ss 8.0	27242604

ETIM

ETIM 4.0	EC001599
ETIM 5.0	EC001599

UNSPSC

UNSPSC 6.01	43172015
UNSPSC 7.0901	43201404
UNSPSC 11	39121311
UNSPSC 12.01	39121311
UNSPSC 13.2	39121311

Approvals

Approvals

Approvals

UL Listed / cUL Listed / cULus Listed

Ex Approvals

Approvals submitted

Approval details

UL Listed 

I/O module - AXL F DO16 FLK 1H - 2701813

Approvals



Drawings

Connection diagram

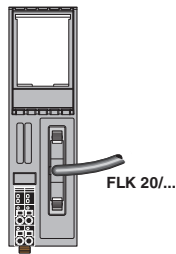

Connection diagram

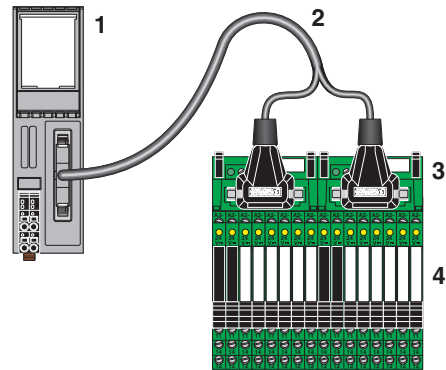

Connection of relay modules

Connection diagram

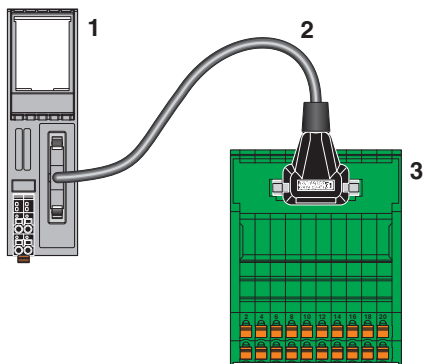

Dimensional drawing

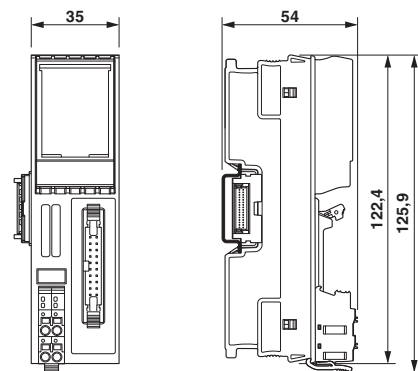

Connection of an interface module

I/O module - AXL F DO16 FLK 1H - 2701813

Block diagram

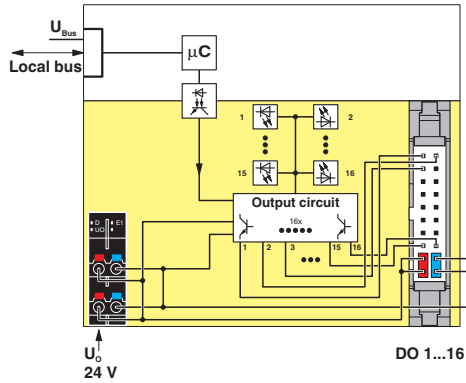

Internal wiring of the terminal points

Diagram

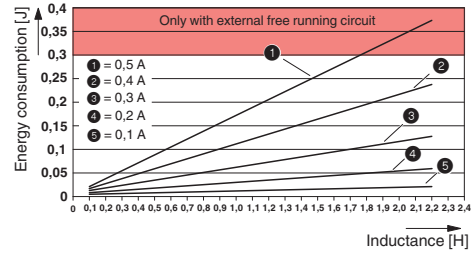

Maximum energy consumption of the outputs when switching off inductive loads
 The diagram shows the maximum amount of energy that may be fed back into the corresponding output groups (outputs 1 to 4, 5 to 8, 9 to 12, 13 to 16) for each switch off procedure when switching off an inductive load without external freewheeling circuit.
 The current data refers to the ohmic DC voltage component of the inductive load.
 Note: Restrict freewheeling voltage to a maximum of -15 V when using an external freewheeling circuit. The external freewheeling circuit has no function in the event of a higher negative voltage.

Компания «Океан Электроники» предлагает заключение долгосрочных отношений при поставках импортных электронных компонентов на взаимовыгодных условиях!

Наши преимущества:

- Поставка оригинальных импортных электронных компонентов напрямую с производств Америки, Европы и Азии, а так же с крупнейших складов мира;
- Широкая линейка поставок активных и пассивных импортных электронных компонентов (более 30 млн. наименований);
- Поставка сложных, дефицитных, либо снятых с производства позиций;
- Оперативные сроки поставки под заказ (от 5 рабочих дней);
- Экспресс доставка в любую точку России;
- Помощь Конструкторского Отдела и консультации квалифицированных инженеров;
- Техническая поддержка проекта, помощь в подборе аналогов, поставка прототипов;
- Поставка электронных компонентов под контролем ВП;
- Система менеджмента качества сертифицирована по Международному стандарту ISO 9001;
- При необходимости вся продукция военного и аэрокосмического назначения проходит испытания и сертификацию в лаборатории (по согласованию с заказчиком);
- Поставка специализированных компонентов военного и аэрокосмического уровня качества (Xilinx, Altera, Analog Devices, Intersil, Interpoint, Microsemi, Actel, Aeroflex, Peregrine, VPT, Syfer, Eurofarad, Texas Instruments, MS Kennedy, Miteq, Cobham, E2V, MA-COM, Hittite, Mini-Circuits, General Dynamics и др.);

Компания «Океан Электроники» является официальным дистрибьютором и эксклюзивным представителем в России одного из крупнейших производителей разъемов военного и аэрокосмического назначения «JONHON», а так же официальным дистрибьютором и эксклюзивным представителем в России производителя высокотехнологичных и надежных решений для передачи СВЧ сигналов «FORSTAR».



JONHON

«JONHON» (основан в 1970 г.)

Разъемы специального, военного и аэрокосмического назначения:

(Применяются в военной, авиационной, аэрокосмической, морской, железнодорожной, горно- и нефтедобывающей отраслях промышленности)

«FORSTAR» (основан в 1998 г.)

ВЧ соединители, коаксиальные кабели,
кабельные сборки и микроволновые компоненты:

(Применяются в телекоммуникациях гражданского и специального назначения, в средствах связи, РЛС, а так же военной, авиационной и аэрокосмической отраслях промышленности).



Телефон: 8 (812) 309-75-97 (многоканальный)

Факс: 8 (812) 320-03-32

Электронная почта: ocean@oceanchips.ru

Web: <http://oceanchips.ru/>

Адрес: 198099, г. Санкт-Петербург, ул. Калинина, д. 2, корп. 4, лит. А