



ON Semiconductor®

November 2016

FDMF3170 Smart Power Stage (SPS) Modules with Integrated Current and Temperature Monitors

Features

- Up to 70 A of Current Handling Capability
- High-Performance, Universal Footprint, Copper-Clip 5 mm x 6 mm PQFN Package
- Fairchild's PowerTrench® MOSFETs for Clean Voltage Waveforms and Reduced Ringing
- 30 V / 25 V Breakdown Voltage MOSFETs for Higher Long Term Reliability
- Optimized FET Pair for Highest Efficiency at 10% ~ 15 % Duty Cycle
- Optimized for Switching Frequencies up to 1 MHz
- Integrated Current Monitor Compliant with Intel's VR13 Accuracy Requirements
- Integrated Temperature Monitor (TMON)
- Catastrophic Fault Detection
 - Thermal Flag (OTP) for Over-Temperature Condition
 - Over-Current Protection FAULT (OCP)
 - High-Side Short Detect FAULT
 - Under-Voltage Lockout (UVLO) on VCC and PVCC
- Fairchild Green Packaging and RoHS Compliance

Applications

- CPU and Memory Voltage Regulators in VR13 Purley Systems
- High-Current Utility Rails in Server Systems
- Communications Infrastructure Systems

Description

The FDMF3170 is ON's next generation of Smart Power Stage (SPS) solutions with fully optimized, ultra-compact, integrated MOSFETs plus driver for high-current, high frequency, and synchronous buck DC-DC converters.

With an integrated approach, the SPS switching power stage is optimized for driver and MOSFET dynamic performance, minimized system inductance, and power MOSFET $R_{DS(ON)}$.

The integration of Power MOSFETs with a driver IC also enables advanced high accuracy module thermal and current monitoring. The FDMF3170 provides an output signal (IMON), which reports the real-time module current. IMON is a very accurate, 5 μ A/A signal representing the real time Power MOSFET drain currents. The IMON signal can be used to replace output filter inductor DCR current sense or resistor sense methods.

The FDMF3170 also includes very accurate module thermal monitor (TMON). TMON is a voltage sourced PTAT signal that is calibrated to provide a 0.8 V output at 25°C with an 8 mV / °C slope.

Ordering Information

Part Number	Rated Output Current	Operating Junction Temperature Range	Package
FDMF3170	70 A	-40°C to 125°C	39-Lead, NON-JEDEC, Smart Power Stage 5 mm x 6 mm, 0.45 mm Pitch (PQFN) Package

FDMF3170 — Smart Power Stage (SPS) Modules with Integrated Current and Temperature Monitors

Application Diagram

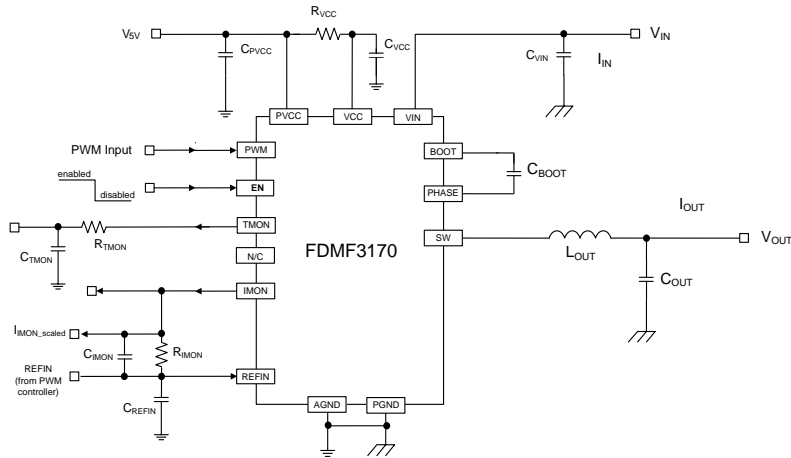

Figure 1. Typical Application Diagram

Functional Block Diagram

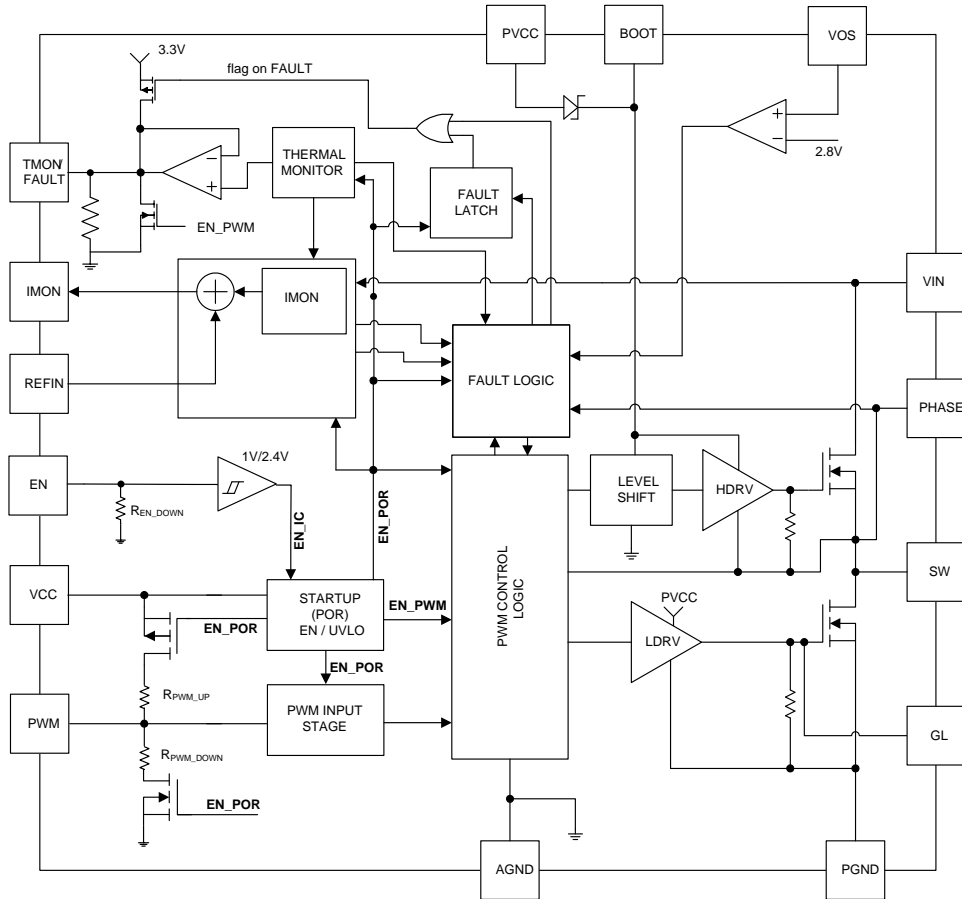

Figure 2. Functional Block Diagram

Pin Configuration

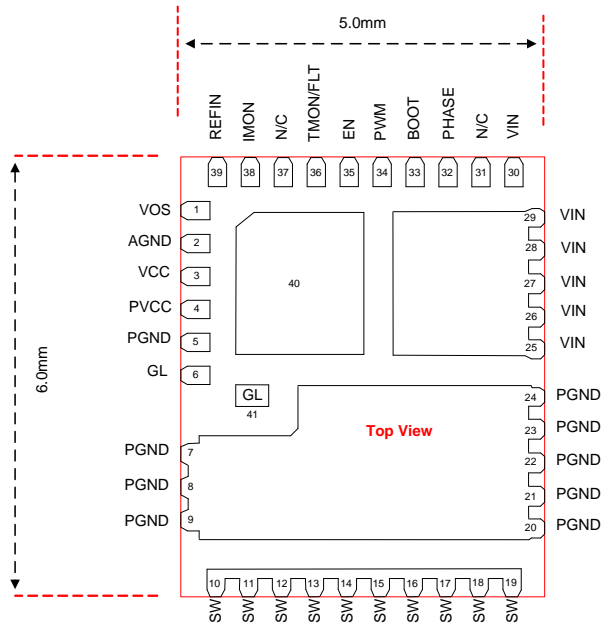

Figure 3. Pin Configuration

Pin Description

Pin #	Name	Function
1	VOS	VR output voltage sensing pin for pre-OVP protection. Leave it floating if not used.
2	AGND	Analog Ground for the analog portions of the IC and for substrate.
3	VCC	Power Supply input for all analog control functions.
4	PVCC	Power Supply input for LS Gate Driver and Boot Diode.
5, 40	PGND	Reserved for PVCC de-coupling capacitor return.
6, 41	GL	Low-Side Gate Monitor.
7-9, 20-24	PGND	Power ground connection for Power Stage high current path.
10-19	SW	Switching node junction between high-and low-side MOSFETs.
25-30	VIN	Input Voltage to Power Stage.
31	N/C	No connect.
32	PHASE	Return Connection for BOOT capacitor.
33	BOOT	Supply for high-side MOSFET gate driver. A capacitor from BOOT to PHASE supplies the charge to turn on the n-channel high side MOSFET. During the freewheeling interval (LS MOSFET on) the high side capacitor is recharged by an internal diode.
34	PWM	PWM input to gate driver IC.
35	EN	EN=LOW disables most blocks inside IC. EN=HIGH enables all blocks inside IC and requires 4 μ s power up time.
36	TMON / FLT	Temperature and FAULT Reporting Pin. Pin sources a (PTAT) voltage of 0.6 V at 0°C with an 8 mV/°C slope when no module FAULT is present. In the event of a module FAULT, this pin pulls HIGH to an internal driver IC rail = 3.0 V typical.
37	N/C	No connect. Some second source options require this pin to be connected.
38	IMON	Current monitor output (output is referenced to REFIN) – 5 μ A/A
39	REFIN	Referenced voltage used for IMON feature. DC input voltage supplied by external source (not generated on SPS driver IC).

Absolute Maximum Ratings

Stresses exceeding the Absolute Maximum Ratings may damage the device. The device may not function or be operable above the recommended operating conditions and stressing the parts to these levels is not recommended. In addition, extended exposure to stresses above the recommended operating conditions may affect device reliability. The absolute maximum ratings are stress ratings only. $T_A = T_J = 25^\circ\text{C}$

Symbol	Parameter		Min.	Max.	Unit
V_{VCC}	Supply Voltage	Referenced to AGND	-0.3	6.0	V
V_{PVCC}	Drive Voltage	Referenced to AGND	-0.3	6.0	V
V_{EN}	Module Enable	Referenced to AGND	-0.3	6.0	V
V_{PWM}	PWM Signal Input	Referenced to AGND	-0.3	VCC +0.3	V
V_{GL}	Low Gate Manufacturing Test Pin	Referenced to AGND	-0.3	6.0	V
V_{IMON}	Current Monitor Output	Referenced to AGND	-0.3	6.0	V
V_{REFIN}	Current Monitor Output Reference	Referenced to AGND	-0.3	6.0	V
$V_{TMON/FAULT}$	Thermal Monitor Output	Referenced to AGND	-0.3	6.0	V
$I_{TMON/FAULT}$	TMON/ FAULT Source Current			5.0	mA
V_{VIN}	Power Input	Referenced to PGND, AGND	-0.3	25.0	V
		Referenced to PGND, AC <20 ns	-0.3	30.0	V
V_{PHASE}	PHASE	Referenced to PGND, AGND (DC Only)	-0.3	25.0	V
		Referenced to PGND, AC <20 ns	-12.0	25.0	V
V_{SW}	Switch Node Input	Referenced to PGND, AGND (DC Only)	-0.3	25.0	V
		Referenced to PGND, AC duration<20 ns	-7.0	25.0	V
V_{BOOT}	Bootstrap Supply	Referenced to AGND (DC Only)	-0.3	30.0	V
		Referenced to AGND, AC duration<20 ns	-0.3	30.0	V
$V_{BOOT-PHASE}$	Boot to PHASE Voltage		-0.3	7.0	V
$I_{O(peak)}$	Output Current	$f_{SW}=300\text{ kHz}, V_{IN}=12\text{ V}, V_{OUT}=1.8\text{ V}$		70	A
		$f_{SW}=1\text{ MHz}, V_{IN}=12\text{ V}, V_{OUT}=1.8\text{ V}$		55	A
θ_{J-A}	Junction-to-Ambient Thermal Resistance			10.5	$^\circ\text{C/W}$
θ_{J-PCB}	Junction-to-PCB Thermal Resistance (Fairchild SPS Evaluation Board)			6.5	$^\circ\text{C/W}$
T_A	Ambient Temperature Range		-40	+125	$^\circ\text{C}$
T_J	Maximum Junction Temperature			+150	$^\circ\text{C}$
T_{STG}	Storage Temperature Range		-55	+150	$^\circ\text{C}$
ESD	Electrostatic Discharge Protection	Human Body Model, JESD22-A114	2000		V
		Charged Device Model, JESD22-C101	1000		V

Recommended Operating Conditions

The Recommended Operating Conditions table defines the conditions for actual device operation. Recommended Operating Conditions are specified to ensure optimal performance to the datasheet specifications. ON does not recommend exceeding them or designing to Absolute Maximum Ratings.

Symbol	Parameter	Min.	Typ.	Max.	Unit
V _{VCC}	Control Circuit Supply Voltage	4.5	5.0	5.5	V
V _{PVCC}	Gate Drive Circuit Supply Voltage	4.5	5.0	5.5	V
V _{VIN}	Output Stage Supply Voltage	4.5	12.0	16.0 ⁽¹⁾	V
V _{REFIN}	REFIN Pin Supply Voltage	0.55	1.2	2.0	V
T _J	Operation Junction Temperature	-40		+125	°C

Note:

- Operating at high VIN can create excessive AC voltage overshoots on the SW-to-GND and BOOT-to-GND nodes during MOSFET switching transient. For reliable SPS operation, SW-to-GND and BOOT-to-GND must remain at or below the Absolute Maximum Ratings shown in the table above.

Electrical Characteristics

Typical value is under VCC=PVCC=5 V and T_A=T_J=+25°C unless otherwise noted. Minimum and maximum values are under VCC=PVCC=5 V±10% and T_J=T_A=0°C to +125°C.

Symbol	Parameter	Condition	Min.	Typ.	Max.	Unit
Basic Operation						
I _{QQ_ENH}	Quiescent Current	I _{QQ} =I _{VCC} + I _{PVCC} , PWM=LOW or HIGH (non-switching), EN=High			9	mA
I _{QQ_ENL}		I _{QQ} =I _{VCC} + I _{PVCC} , PWM=LOW or HIGH (non-switching), EN=Low			2.15	mA
V _{UVLO}	UVLO Threshold	VCC and PVCC Rising	3.50	3.80	4.25	V
V _{UVLO_HYST}	UVLO Hysteresis			0.4		V
t _{D_POR}	POR Delay to Enable IC	VCC UVLO Rising to Internal PWM Enable			125	µs
EN Input						
V _{IH_EN}	High-Level Input Voltage		2.4			V
V _{IL_EN}	Low-Level Input Voltage				1.0	V
R _{PLD_EN}	Pull-Down Resistance			130		kΩ
t _{PD_ENH}	Propagation Delay for EN 0→1	PWM=GND, Delay Between EN from LOW to HIGH to GL from LOW to HIGH	20		32	µs
t _{PD_ENL}	Propagation Delay for EN 1→0	PWM=GND, Delay Between EN from HIGH to LOW to GL from HIGH to LOW			50	ns
PWM Input						
R _{UP_PWM}	Pull-Up Impedance	Typical Values: T _A =T _J =25°C VCC=PVCC=5 V Min./Max. Values: T _A =T _J =-40°C to 150°C VCC=PVCC=5 V ± 10%		23		kΩ
R _{DN_PWM}	Pull-Down Impedance			10		kΩ
V _{IH_PWM}	PWM High Level Voltage		2.35	2.45	2.55	V
V _{TRL_HI}	3-State Upper Threshold		2.1	2.2	2.3	V
V _{TRL_LO}	3-State Lower Threshold		0.9	1.0	1.1	V
V _{IL_PWM}	PWM Low Level Voltage		0.65	0.75	0.85	V
V _{HIZ_PWM}	3-State Open Voltage		1.3	1.5	1.7	V

Electrical Characteristics

Typical value is under VCC=PVCC=5 V and T_A=T_J=+25°C unless otherwise noted. Minimum and maximum values are under VCC=PVCC=5 V±10% and T_J=T_A=0°C to +125°C.

Symbol	Parameter	Condition	Min.	Typ.	Max.	Unit
PWM Propagation Delays and Dead Times (T_A=25°C, VCC / PVCC=5 V, f_{sw}=1 MHz, I_{out}=20 A)						
t _{PD_PHGLL}	PWM HIGH Propagation Delay	PWM Going HIGH to GL going LOW, V _{IH_PWM} to 90% GL		15	20	ns
t _{PD_PLGHL}	PWM LOW Propagation Delay	PWM Going LOW to GH going LOW, V _{IL_PWM} to 90% GH		20	25	ns
t _{PD_TSGHH}	Exiting 3-State Propagation Delay	PWM (from 3-State) going HIGH to GH going HIGH, V _{IH_PWM} to 10% GH			30	ns
t _{PD_TSGLH}	Exiting 3-State Propagation Delay	PWM (from 3-State) going LOW to GL going HIGH, V _{IL_PWM} to 10% GL			30	ns
t _{D_DEADON}	LS Off to HS on Dead Time	GL <= 0.5 V to SW>1.2 V. PWM Transition 0→1	6	9	12	ns
t _{D_DEADOFF}	HS Off to LS on Dead Time	SW <= 1.2 V to GL>=3 V, PWM Transition 1→0	4	6	8	ns
t _{D_HOLD-OFF1}	PWM High to 3-State Hold Off Time	PWM Going High to HS going Off	20		50	ns
t _{D_HOLD-OFF2}	PWM Low to 3-State Hold Off Time	PWM Going Low to LS going Off	20		50	ns
Minimum PWM HIGH / LOW Time						
t _{MIN_PWM_HIGH}	Forced Minimum PWM HIGH	Forced Internal PWM Pulse Required for GH to Charge from 0 to BOOT-SW		30		ns
t _{MIN_PWM_LOW}	Forced Minimum PWM LOW	Forced Internal PWM LOW Pulse Required for GL to Charge from 0 to PVCC		40		ns
High-Side Driver (HDRV, VCC=PVCC=5 V)						
R _{SOURCE_GH}	Output Impedance, Sourcing	Source Current=100 mA		0.9		Ω
I _{SOURCE_GH}	Output Sourcing Peak Current	GH-PHASE=0 V		2		A
R _{SINK_GH}	Output Impedance, Sinking	Sink Current=100 mA		0.5		Ω
I _{SINK_GH}	Output Sinking Peak Current	GH-PHASE=4.5 V		3		A
t _{R_GH}	Rise Time	GH=10% to 90%, C _{LOAD} =1.3 nF		9		ns
t _{F_GH}	Fall Time	GH=90% to 10%, C _{LOAD} =1.3 nF		3		ns
Low-Side Driver (LDRV, VCC=PVCC=5V)						
R _{SOURCE_GL}	Output Impedance, Sourcing	Source Current=100 mA		0.5		Ω
I _{SOURCE_GL}	Output Sourcing Peak current	GL=0 V		3		A
R _{SINK_GL}	Output Impedance, Sinking	Sink Current=100 mA		0.2		Ω
I _{SINK_GL}	Output Sinking Peak current	GL=4.5 V		6		A
t _{R_GL}	Rise Time	GL=10% to 90%, C _{LOAD} =7.0 nF		9		ns
t _{F_GL}	Fall Time	GL=90% to 10%, C _{LOAD} =7.0 nF		6		ns
Thermal Monitor Voltage						
V _{TMON_25C}	Thermal Monitor Voltage	T _A =T _J =25°C	0.776	0.800	0.824	V
V _{TMON_150C}		T _A =T _J =150°C	1.764	1.800	1.836	V
V _{TMON_SLOPE}	Thermal Monitor Voltage Slope	Guaranteed by design	7.8	8.0	8.2	mV/°C
I _{SOURCE_TMON}	TMON Source Current	5 V _{CC} , 25°C		850		μA
I _{SINK_TMON}	TMON Sink Current	5 V _{CC} , 25°C		40		μA

Electrical Characteristics

Typical value is under VCC=PVCC=5 V and T_A=T_J=+25°C unless otherwise noted. Minimum and maximum values are under VCC=PVCC=5 V±10% and T_J=T_A=0°C to +125°C.

Symbol	Parameter	Condition	Min.	Typ.	Max.	Unit	
IMON Block Times							
t _{blank_HSOFF}	HS Off to LS On Blanking Stop Time	IMON Blanking Time for PWM Transition 1→0		70		ns	
T _{blank_HSON}	HS On to LS Off Blanking Stop Time	IMON Blanking Time for PWM Transition 0→1		70		ns	
BW _{IMON}	IMON Amplifier Gain BW	L=150 nH, V _{IN} =12 V, V _{OUT} =1.8 V, f _{SW} =800 kHz	5.0	7.5		MHz	
t _{delay}	IMON Propagation Delay Time	L=150 nH, V _{IN} =12 V, V _{OUT} =1.8 V, f _{SW} =800 kHz, IMON Peak to IL Peak		60	75	ns	
IMON Operating Range (T_A=T_J=-40°C to 125°C, VCC / PVCC=4.5 V to 5.5 V, VIN=5 V to 16 V)							
V _{IMON}	Dynamic Range at IMON Pin		0.5		2.5	V	
IMON Accuracy (T_A=T_J=25°C to 125°C, VCC / PVCC=4.75 V to 5.25 V, VIN=12 V)⁽²⁾							
I _{MON_SLOPE}		I _{OUT} =-20 A to 50 A	4.75	5.00	5.25	µA/A	
V _{IMON_SLOPE}		I _{OUT} =-20 A to 50 A	4.75	5.00	5.25	µA/A	
V _{IMON_10A}	R _{IMON} =1 kΩ – resistor placed from IMON to REFIN and used to measure IMON-REFIN differential voltage Current Monitor Voltage (V _{IMON-REFIN}) V _{REFIN} Range=0.55 V to 2.0 V	I _{OUT} =-10 A, Voltage is Referenced to REFIN Pin	-53.5	-50.0	-46.5	mV	
V _{IMON_10A}		I _{OUT} =10 A, Voltage is Referenced to REFIN Pin	46.5	50.0	53.5	mV	
V _{IMON_20A}		I _{OUT} =20 A, Voltage is Referenced to REFIN Pin	95.5	100.0	105.0	mV	
V _{IMON_30A}		I _{OUT} =30 A, Voltage is Referenced to REFIN Pin	142.5	150.0	157.5	mV	
V _{IMON_40A}		I _{OUT} =40 A, Voltage is Referenced to REFIN Pin	190.0	200.0	210.0	mV	
FAULT Report							
V _{FAULT}	Fault Report Voltage		2.9			V	
T _{D_FAULT}	Fault Report Delay Time				100	ns	
Over-Temperature Protection (OTP) FAULT							
OTP	Over-Temperature Protection Accuracy	Driver IC Temperature	132	136	140	°C	
OTP_hysteresis	OTP Hysteresis	Driver IC Temperature	10	15	20	°C	
HS Cycle-By-Cycle I-Limit							
t _{D_ILimit-COMP}	I-limit Comparator Input-Output Propagation Delay	Input Signal=380 mV, dv/dt=0.2 mV/nsec.		60		ns	
t _{BLANK_ILimit}	I-limit Blanking Time	De-glitch Filter (Blanking) Time for I-Limit Comparator Trip		33		ns	
t _{D_ILimit}	I-limit Detect to TMON/FAULT# Signal=HIGH				100	ns	
I _{LIM1}	Over-Current Protection Accuracy	T _A =T _J =25° to 125°C	74	80	86	A	
I _{LIM_HYS}	OCP Hysteresis			10		A	
Negative Over-Current (NOCP) FAULT							
I _{NOCP_LOW}	NOCP Trip LOW Level		-70	-60	-50	A	
I _{NOCP_HYS}	NOCP Hysteresis			20		A	

Electrical Characteristics

Typical value is under $V_{CC}=PV_{CC}=5\text{ V}$ and $T_A=T_J=+25^\circ\text{C}$ unless otherwise noted. Minimum and maximum values are under $V_{CC}=PV_{CC}=5\text{ V}\pm 10\%$ and $T_J=T_A=0^\circ\text{C}$ to $+125^\circ\text{C}$.

Symbol	Parameter	Condition	Min.	Typ.	Max.	Unit
HS-Short Detect Fault						
V_{HS_SHORT}	HS_short Comparator Reference Voltage			0.2		V
$t_{BLANK_HS-short}$	HS Short Detect Blanking Time	Blanking Time Needed for Noise			50	ns
Pre-OVP						
V_{OVP_H}	OVP Comparator Reference Voltage	Rising Threshold	2.58	2.80	2.92	V
V_{OVP_L}		Falling Threshold		1.6		V
Boot Diode						
V_F	Forward-Voltage Drop	$I_F=10\text{ mA}$		0.4		V
V_R	Breakdown Voltage		30			V

Note:

- Imon performance is guaranteed by independent ATE testing of High-side and Low-side slope and offset.

Typical Performance Characteristics

Test conditions: $V_{IN}=12\text{ V}$, $V_{CC}=P_{VCC}=5\text{ V}$, $V_{OUT}=1.8\text{ V}$, $L_{OUT}=150\text{ nH}$, $T_A=+25^\circ\text{C}$ and natural convection cooling unless otherwise noted.

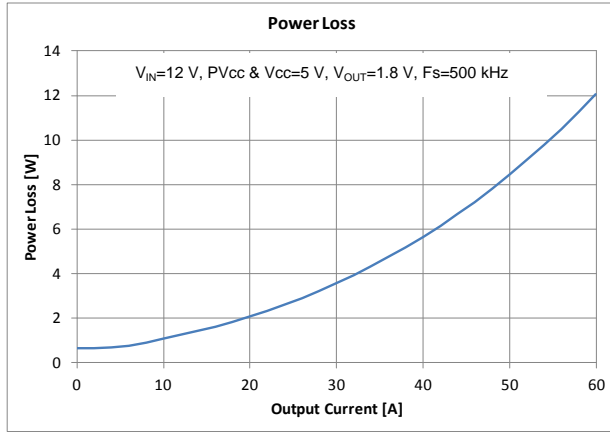

Figure 4. Power Loss vs. Output Current

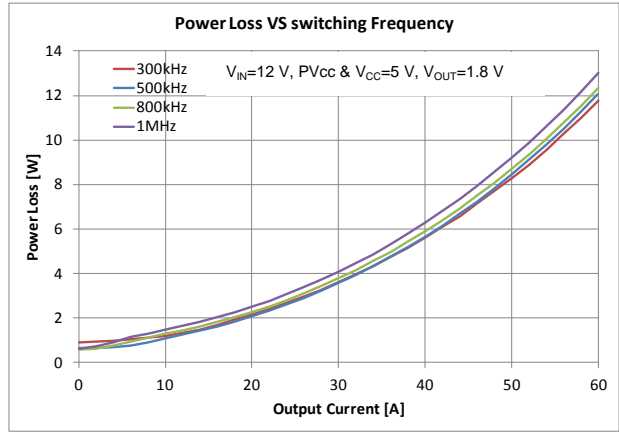

Figure 5. Power Loss vs. Switching Frequency

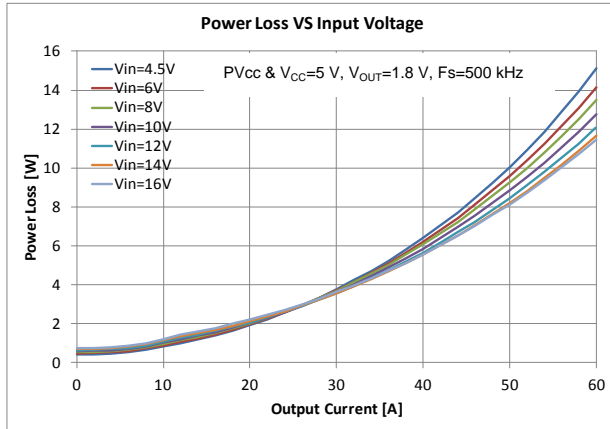

Figure 6. Power Loss vs. Input Voltage

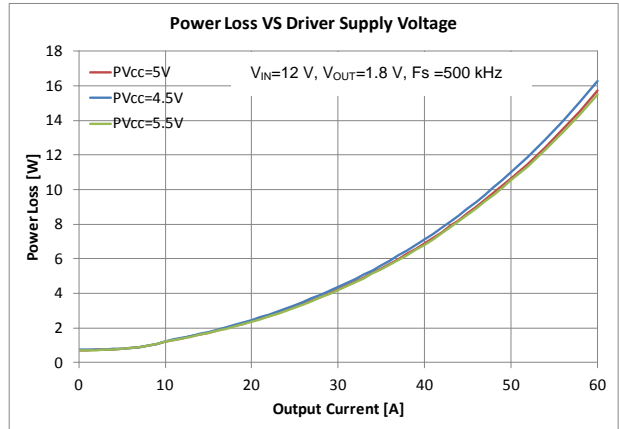

Figure 7. Power Loss vs. Driver Supply Voltage

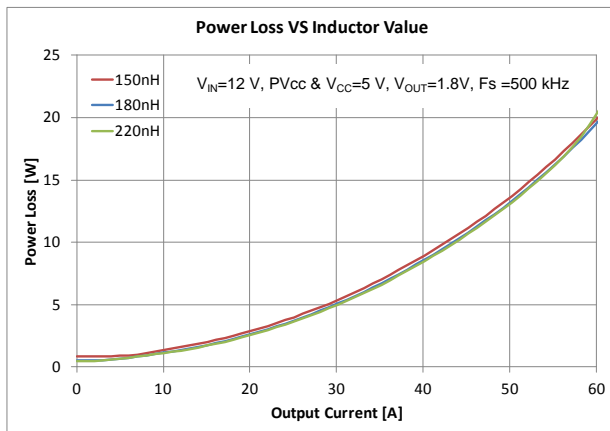

Figure 8. Power Loss vs. Output Inductor

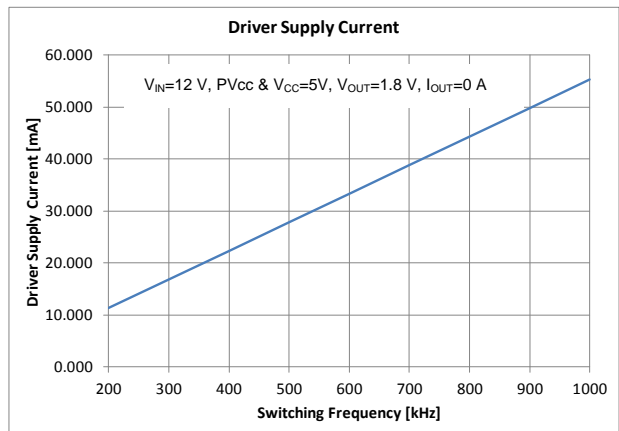

Figure 9. Driver Supply Current vs. Switching Frequency

Typical Performance Characteristics (Continued)

Test Conditions: $V_{IN}=12\text{ V}$, $V_{CC}=P_{VCC}=5\text{ V}$, $V_{OUT}=1.8\text{ V}$, $L_{OUT}=150\text{ nH}$, $T_A=+25^\circ\text{C}$ and natural convection cooling unless otherwise noted.

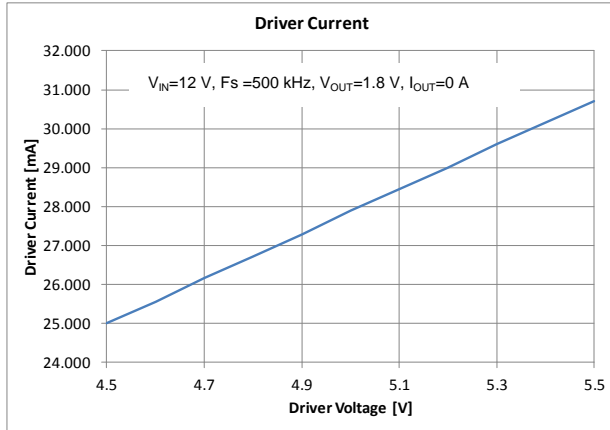

Figure 10. Driver Current vs. Driver Voltage

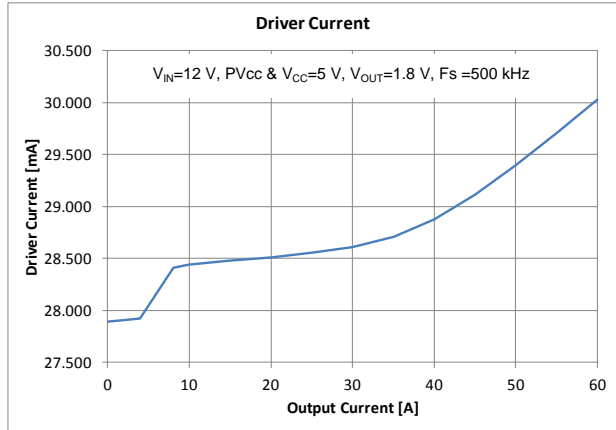

Figure 11. Driver Current vs. Output Current

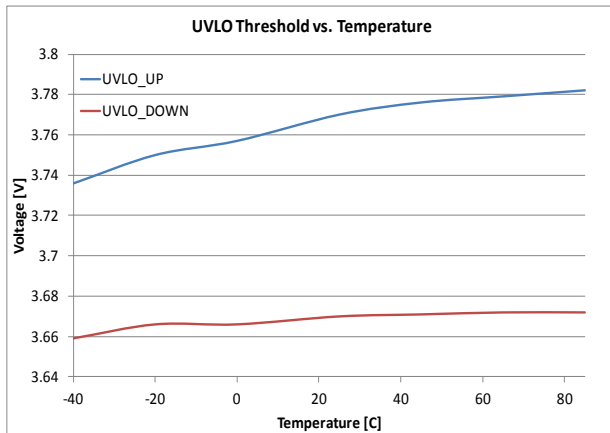

Figure 12. UVLO Threshold vs. Temperature

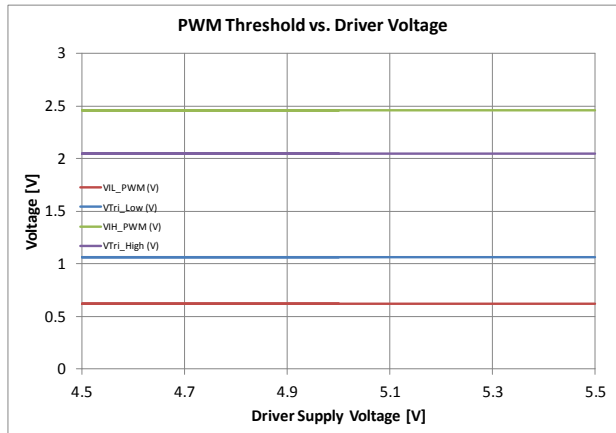

Figure 13. PWM Threshold vs. Driver Voltage

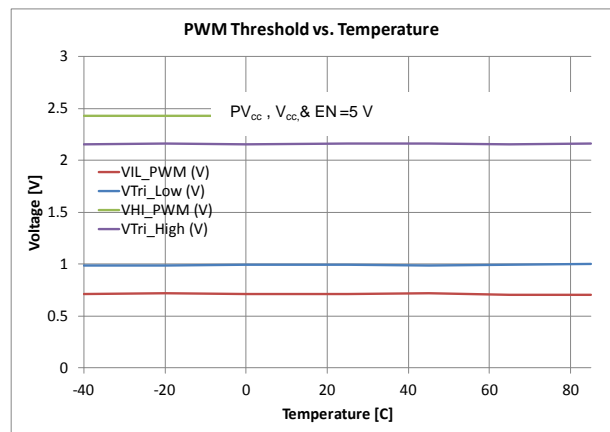

Figure 14. PWM Threshold vs. Temperature

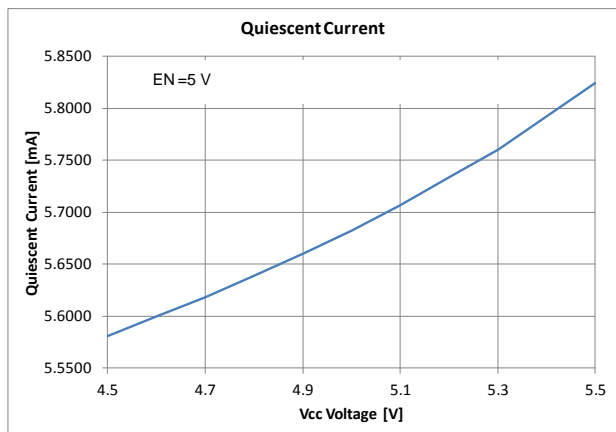

Figure 15. Quiescent Current vs. V_{CC} Voltage

Typical Performance Characteristics (Continued)

Test Conditions: $V_{IN}=12\text{ V}$, $V_{CC}=P_{VCC}=5\text{ V}$, $V_{OUT}=1.8\text{ V}$, $L_{OUT}=150\text{ nH}$, $T_A=+25^\circ\text{C}$ and natural convection cooling unless otherwise noted.

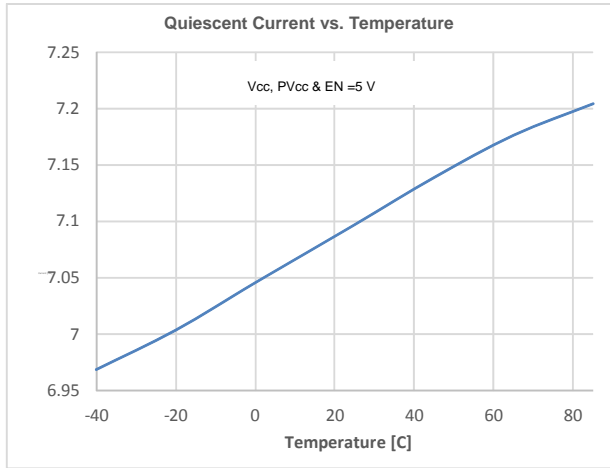

Figure 16. Quiescent Current vs. Temperature

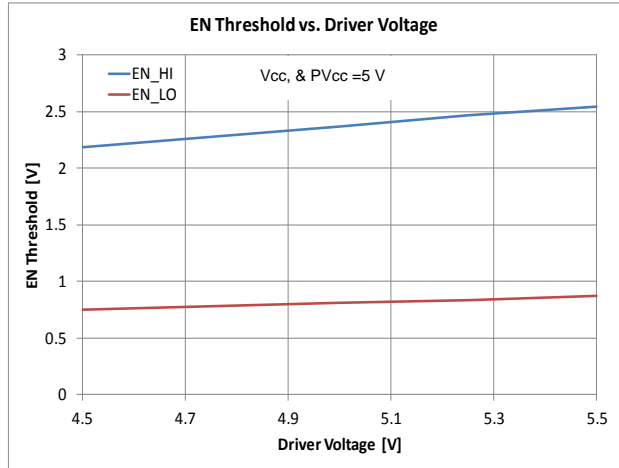

Figure 17. EN Threshold vs. Driver Voltage

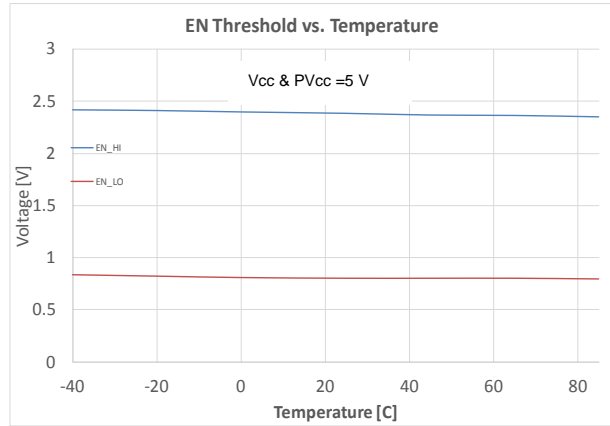

Figure 18. EN Threshold vs. Temperature

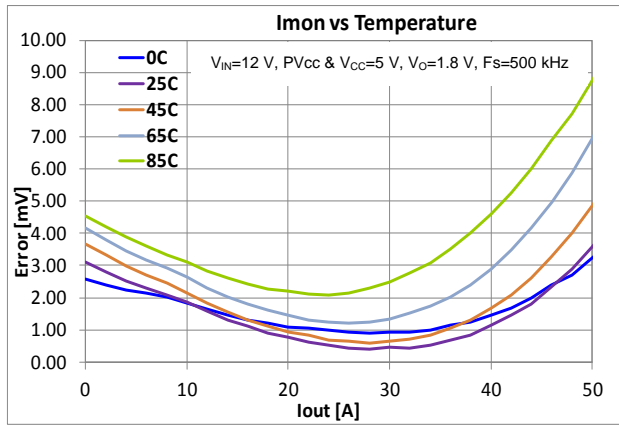

Figure 19. Imon Accuracy vs. Temperature

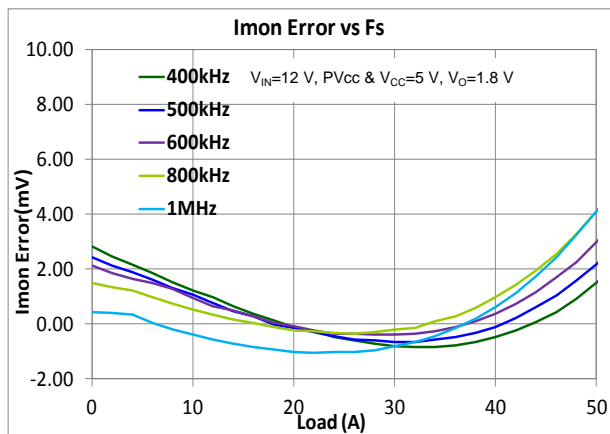

Figure 20. Imon Accuracy vs. Frequency

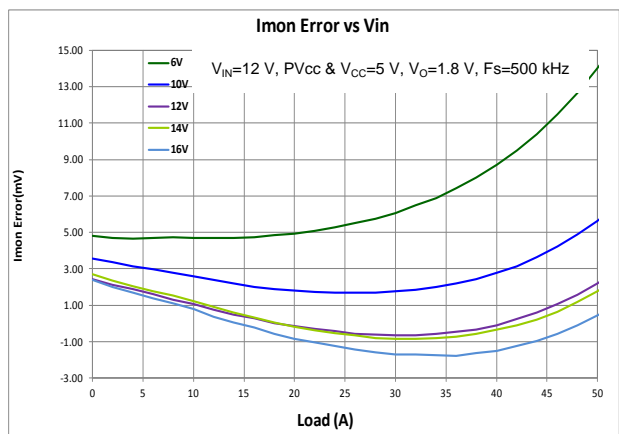

Figure 21. Imon Accuracy vs. VIN

Typical Performance Characteristics

Test Conditions: $V_{IN}=12\text{ V}$, $V_{CC}=P_{VCC}=5\text{ V}$, $V_{OUT}=1.8\text{ V}$, $L_{OUT}=150\text{ nH}$, $T_A=+25^\circ\text{C}$ and natural convection cooling unless otherwise noted.

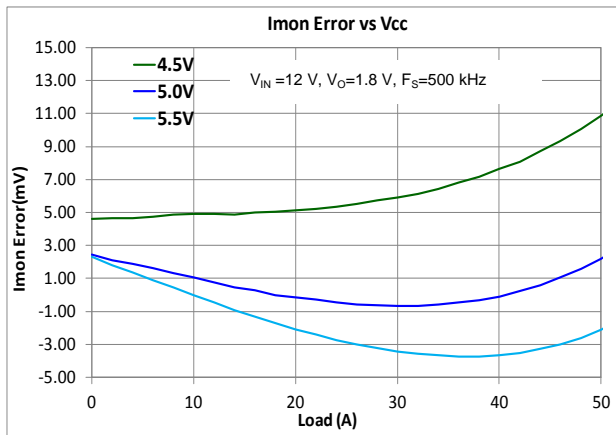

Figure 22. IMON Accuracy vs. VCC

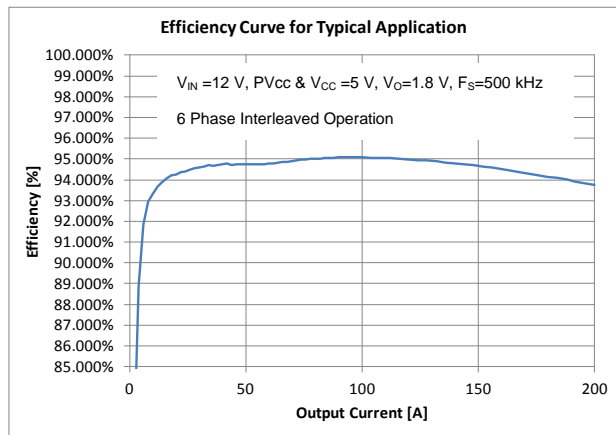

Figure 23. Efficiency Curve for Typical Application

Functional Description

The SPS FDMF3170 is a driver plus MOSFET module optimized for the synchronous buck converter topology. A PWM input signal is required to properly drive the high-side and the low-side MOSFETs. The part is capable of driving speed up to 1 MHz.

EN and UVLO

The SPS FDMF3170 is enabled by both EN pin input signal and V_{CC} / PV_{CC} UVLO. Table 1 summarizes the enable and disable logics. With EN low and V_{CC} UVLO, SPS is fully shut down. If V_{CC} is ready but EN is low, SPS goes to sleep mode with very low quiescent current, where only critical circuitry such as the bandgap and general housekeeping circuitry are alive. The part should also read fuses/program itself during this state.

Table 1. UVLO and Driver State

V_{CC} UVLO	PV_{CC} UVLO	EN	Driver State
0	X	X	Full driver shutdown (GH, GL=0), requires 40 μ s for startup
1	X	0	Partial driver shutdown (GH, GL=0), requires 10 μ s for startup
1	0	1	Driver analog circuitry alive but outputs forced into tri-state (GH, GL=0)
1	1	1	Enabled (GH/GL follow PWM)
X	X	Open/0	Disabled (GH, GL=0)

The FDMF3170 needs 40 μ s time to go from fully shutdown mode to power ready mode. The time is 10 μ s from partial shutdown mode power ready. Before power is ready, TMON pin is strongly pull low with a 50 Ω resistor. As a result, TMON pin can also be used as a power ready indicator.

3-State PWM Input

The FDMF3170 incorporates a 3-state 3.3 V PWM input gate drive design. The 3-state gate drive has both logic HIGH and LOW levels, along with a 3-state shutdown window. When the PWM input signal enters and remains within the 3-state window for a defined hold-off time ($t_{D_HOLD-OFF}$), both GL and GH are pulled LOW. This feature enables the gate drive to shut down both high-side and low-side MOSFETs to support features such as phase shedding, a common feature on multi-phase voltage regulators.

Table 2. Enable / PWM / 3-State / OFF# Logic

Enable	PWM	GH	GL
0	X	0	0
1	3-State	0	0
1	0	0	1
1	1	1	0

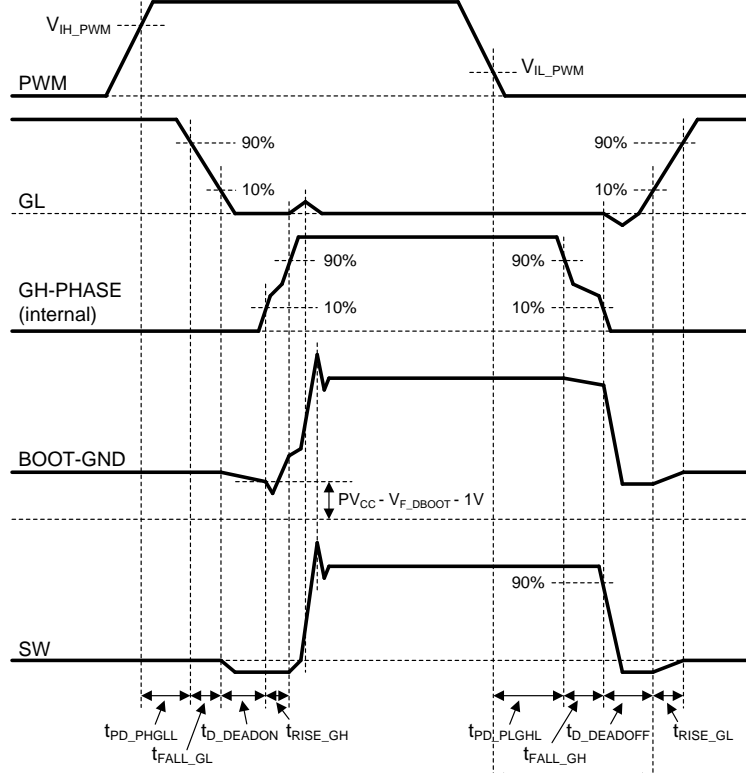

t_{PD_PHGLL} = PWM HI to GL LO, V_{IH_PWM} to 90% GL
 t_{FALL_GL} = 90% GL to 10% GL
 t_{D_DEADON} = LS Off to HS On Dead Time, 10% GL to $V_{BOOT_GND} \leq PV_{CC} - V_{F_DBOOT} - 1V$ or BOOT-GND dip start point
 t_{RISE_GH} = 10% GH to 90% GH, $V_{BOOT_GND} \leq PV_{CC} - V_{F_DBOOT} - 1V$ or BOOT-GND dip start point to GL bounce start point
 t_{PD_PLGHL} = PWM LO to GH LO, V_{IL_PWM} to 90% GH or BOOT-GND decrease start point, $t_{PD_PLGLH} - t_{D_DEADOFF} - t_{FALL_GH}$
 t_{FALL_GH} = 90% GH to 10% GH, BOOT-GND decrease start point to 90% V_{SW} or GL dip start point
 $t_{D_DEADOFF}$ = HS Off to LS On Dead Time, 90% V_{SW} or GL dip start point to 10% GL
 t_{RISE_GL} = 10% GL to 90% GL
 t_{PD_PLGLH} = PWM LO to GL HI, V_{IL_PWM} to 10% GL

Figure 24. PWM Timing Diagram

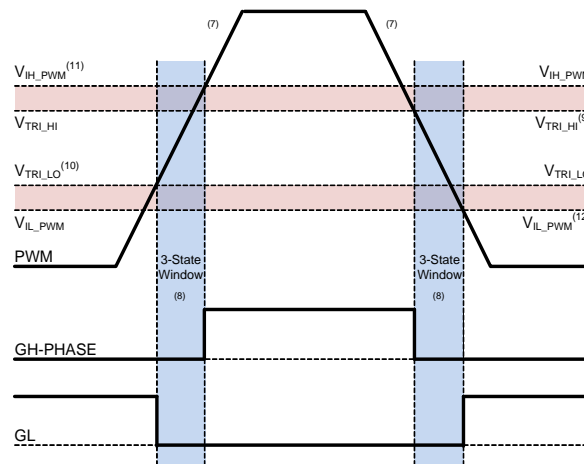

Figure 25. PWM Threshold Definition

Notes:

- The timing diagram in Figure 24 assumes very slow ramp on PWM.
- Slow ramp of PWM implies the PWM signal remains within the 3-state window for a time $\gg t_{D_HOLD-OFF}$.
- V_{TRI_HI} = PWM trip level to enter 3-state on PWM falling edge.
- V_{TRI_LO} = PWM trip level to enter 3-state on PWM rising edge.
- V_{IH_PWM} = PWM trip level to exit 3-state on PWM rising edge and enter the PWM HIGH logic state.
- V_{IL_PWM} = PWM trip level to exit 3-state on PWM falling edge and enter the PWM LOW logic state.

Power Sequence

The FDMF3170 requires four (4) input signals to conduct normal switching operation: VIN, VCC / PVCC, PWM, and EN. All combinations of power sequences are available. The below example of a power sequence is for a reference application design:

- From no input signals
 - VIN On: Typical 12 V_{DC}
 - VCC / PVCC On: Typical 5 V_{DC}
 - EN HIGH: Typical 5 V_{DC}
 - PWM Signaling: 3.3 V HIGH / 0 V LOW

The VIN pins are tied to the system main DC power rail.

PVCC and VCC pins are tied together to supply gate driving and logic circuit powers from the system V_{CC} rail. Or the PVCC pin can be directly tied to the system V_{CC} rail, and the VCC pin is powered by PVCC pin through a filter resistor located between PVCC pin and VCC pin. The filter resistor reduces switching noise impact from PV_{CC} to V_{CC}.

The EN pin can be tied to the V_{CC} rail with an external pull-up resistor and it will maintain HIGH once the V_{CC}

rail turns on. Or the EN pin can be directly tied to the PWM controller for other purposes.

High-Side Driver

The High-Side Driver (HDRV) is designed to drive a floating N-channel MOSFET (Q1). The bias voltage for the high-side driver is developed by a bootstrap supply circuit, consisting of the internal Schottky diode and external bootstrap capacitor (C_{BOOT}). During startup, the SW node is held at PGND, allowing C_{BOOT} to charge to PVCC through the internal bootstrap diode. When the PWM input goes HIGH, HDRV begins to charge the gate of the high-side MOSFET (internal GH pin). During this transition, the charge is removed from the C_{BOOT} and delivered to the gate of Q1. As Q1 turns on, SW rises to V_{IN}, forcing the BOOT pin to V_{IN} + V_{BOOT}, which provides sufficient V_{GS} enhancement for Q1. To complete the switching cycle, Q1 is turned off by pulling HDRV to SW. C_{BOOT} is then recharged to PVCC when the SW falls to PGND. HDRV output is in phase with the PWM input. The high-side gate is held LOW when the driver is disabled or the PWM signal is held within the 3-state window for longer than the 3-state hold-off time, t_{D_HOLD-OFF}.

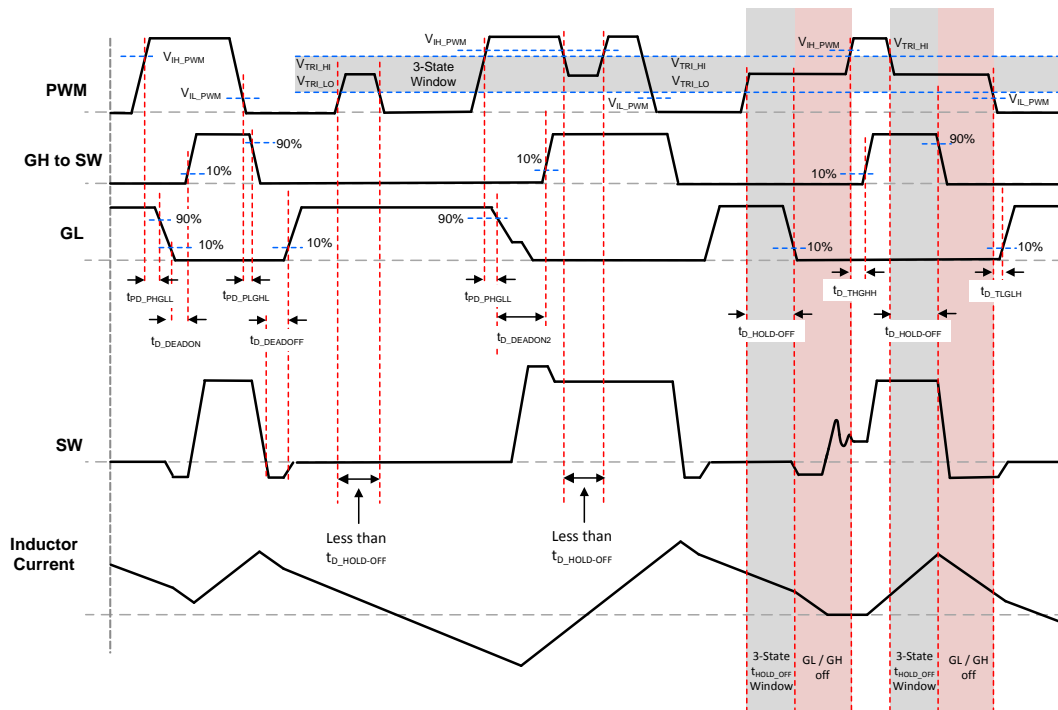

NOTES:

t_{PD_XXX} = propagation delay from external signal (PWM, SMOD#, etc.) to IC generated signal. Example (t_{PD_PHGHL} - PWM going HIGH to LS V_{GS} (GL) going LOW).
 t_{D_XXX} = delay from IC generated signal to IC generated signal. Example (t_{D_DEADON} - LS V_{GS} LOW to HS V_{GS} HIGH).

PWM

t_{PD_PHGHL} = PWM rise to LS V_{GS} fall, V_{IH_PWM} to 90% LS V_{GS}
 t_{PD_PLGHL} = PWM fall to HS V_{GS} fall, V_{IL_PWM} to 90% HS V_{GS}
 t_{PD_PHGHL} = PWM rise to HS V_{GS} rise, V_{IH_PWM} to 10% HS V_{GS} (SMOD# held LOW)

SMOD#

t_{PD_SLGHL} = SMOD# fall to LS V_{GS} fall, 90% to 90% LS V_{GS}
 t_{PD_SHGLH} = SMOD# rise to LS V_{GS} rise, 10% to 10% LS V_{GS}

Exiting 3-state

t_{PD_TSGHH} = PWM 3-state to HIGH to HS V_{GS} rise, V_{IH_PWM} to 10% HS V_{GS}
 t_{PD_TSGHL} = PWM 3-state to LOW to LS V_{GS} rise, V_{IL_PWM} to 10% LS V_{GS}

Dead Times

t_{D_DEADON} = LS V_{GS} fall to HS V_{GS} rise, LS-comp trip value to 10% HS V_{GS}
 t_{D_DEADOFF} = VSWH fall to LS V_{GS} rise, SW-comp trip value to 10% LS V_{GS}

Figure 26. PWM HIGH / LOW / 3-State Timing Diagram

Low-Side Driver

The Low-Side Driver (LDRV) is designed to drive the gate-source of a ground referenced low $R_{DS(ON)}$ N-channel MOSFET (Q2). The bias for LDRV is internally connected between PVCC and PGND. When the driver is enabled, the driver's output is 180 ° out of phase with the PWM input. When the driver is disabled, LDRV is held LOW.

Dead-Times

The driver IC design ensures minimum MOSFET dead times, while eliminating potential shoot-through (cross-conduction) currents. To ensure optimal module efficiency, body diode conduction times must be reduced to the low nano-second range during CCM and DCM operation. Delay circuitry is added to prevent gate overlap during both the low-side MOSFET off to high-side MOSFET on transition and the high-side MOSFET off to low-side MOSFET on transition.

Exiting 3-State Condition

When exiting a valid 3-state condition, the gate driver of the FDMF3170 follows the PWM input command. If the PWM input goes from 3-state to LOW, the low-side MOSFET is turned on. If the PWM input goes from 3-state to HIGH, the high-side MOSFET is turned on. This is illustrated in Figure 26.

Boot Capacitor Refresh

FDMF3170 monitors the low Boot-SW voltage. If EN, VCC and PVCC are ready, but the voltage across the boot capacitor voltage is lower than 2.4 V, FDMF3170 ignores the PWM input signal and starts the boot refresh circuit. The boot refresh circuit turns on the low side MOSFET with a 100 ns~200 ns narrow pulse in every 7~14 μ s until Boot-SW voltage is above 3.3 V.

Current Monitor (IMON)

The SPS current monitor accurately senses high-side and low-side MOSFET currents. The currents are summed together to replicate the output filter inductor current. The signal is reported from the SPS module in the form of a 5 μ A/A current signal ($I_{IMON-REFIN}$). The IMON signal will be referenced to an externally supplied signal (REFIN) and differentially sensed by an external analog / digital PWM controller.

The motivation for the IMON feature is to replace the industry standard output filter DCR sensing, or output current sense using an external precision resistor. Both techniques are lossy and lead to reduced system efficiency. Inductor DCR sensing is also notoriously inaccurate for low value DCR inductors. Figure 27 shows a comparison between conventional inductor DCR sensing and the unique IMON feature.

The accuracy on IMON signal is $\pm 5\%$ from 10 A to 40 A output current. For the SPS module, parameters that can affect IMON accuracy are tightly controlled and trimmed at the MOSFET / IC production stage. The user can easily incorporate the IMON feature and accuracy replacing the traditional current sensing methods in multi-phase VR applications.

The REFIN voltage is an externally supplied DC voltage. The DC voltage can be supplied from any DC rail capable of supplying 100 μ A, such as a PWM controller or other power rail in system.

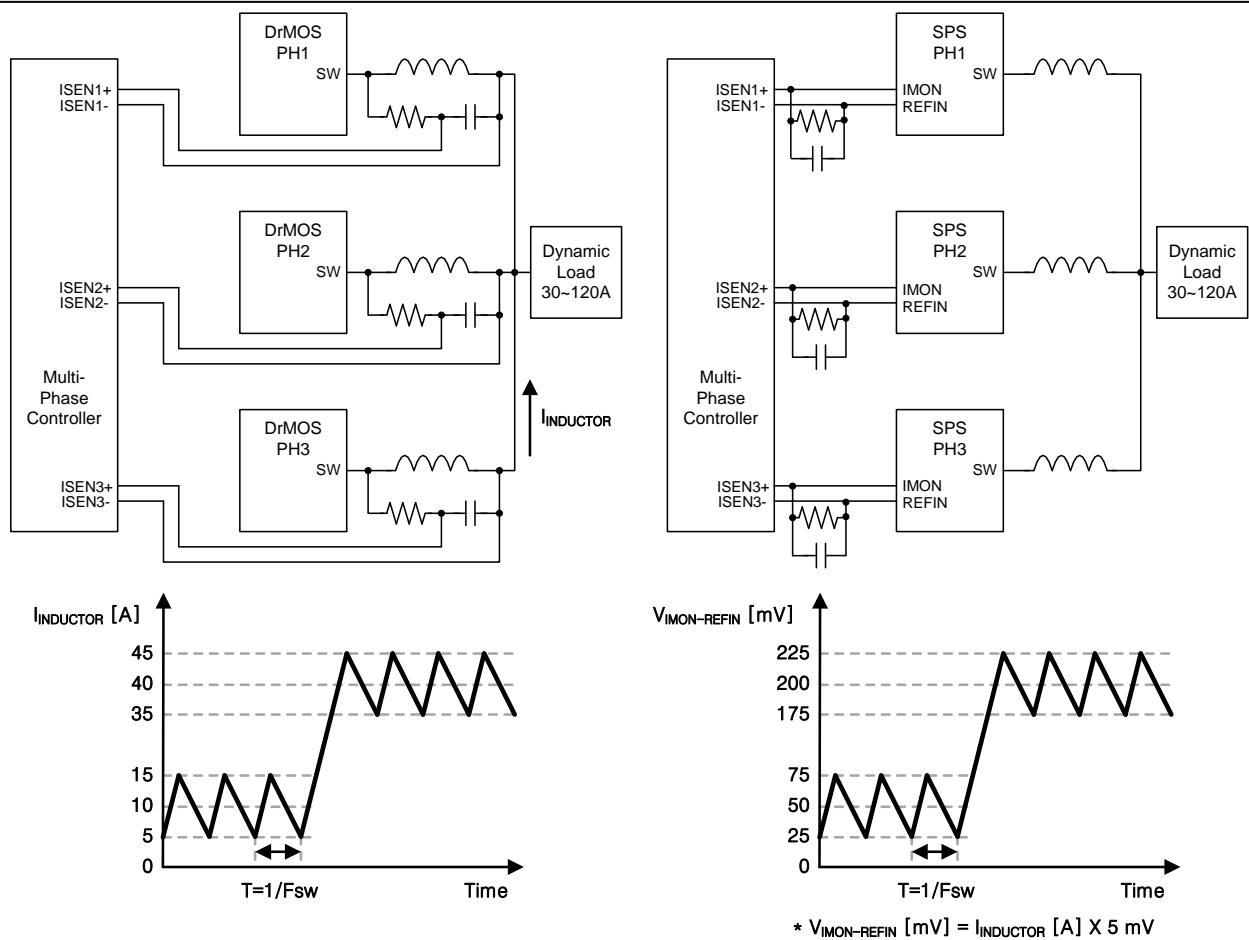

Figure 27. DrMOS with Inductor DCR Sensing vs. SPS with IMON

Temperature Monitor / Fault Flag (TMON / FAULT)

The TMON / FAULT pin on FDMF3170 is a thermal monitor output in normal operation. Before power is ready, TMON pin is strongly pulled low with a 50ohm resistor. As a result, it can be used as a power ready indicator. Also, this pin is used as a module FAULT flag pin if there is OCP, OTP or high side FET shorted.

The TMON pin output is a Proportional to Absolute Temperature (PTAT) voltage sourced signal referenced to AGND when no module FAULT is present. It will typically output 0.6 V at 0°C and 1.8 V at 150°C with 8 mV / °C typical slope.

TMON pins from multiple FDMF3170 modules (used in multi-phase topologies) can be tied together to share a common thermal bus. Operating with this configuration will force the thermal bus signal to report the highest voltage output TMON signal to the controller (highest temperature). The TMON output has a low output impedance when sourcing current and a high output impedance when sinking current.

The TMON signal reported from the module pin is a buffered version of an internal TMON signal. Configuring the SPS module to share a common thermal bus will still permit each module to safely monitor its own temperature since the internal TMON

signal is unaffected by the common thermal bus configuration.

The TMON voltage has a slope defined in Equation (1).

$$\frac{V_{TMON} [V]}{T_J [^{\circ}C]} = \frac{1.8 V - 0.6 V}{150^{\circ}C - 0^{\circ}C} = 8 [mV / ^{\circ}C] \quad (1)$$

The TMON pin pulls to an internal 3.0 V typical rail capable of sourcing 5 mA current during any of the FAULT conditions listed below.

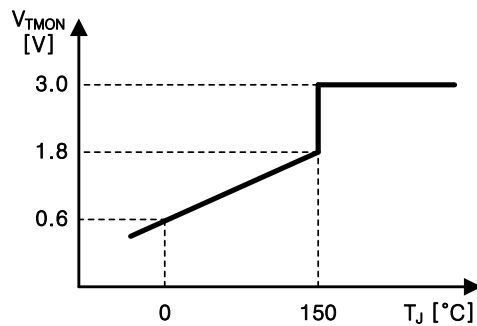

* $R_{TMON} = 1 \text{ k}\Omega$, $C_{TMON} = 1 \text{ nF}$

Figure 28. SPS T_J vs. V_{TMON}

Over-Temperature Protection (OTP)

An over-temperature event is considered catastrophic in nature. OTP raises fault flag HIGH once TMON exceeds 140°C temperature. Driver still responds to PWM commands (NO tri-state shutdown). Once TMON falls below 125°C, fault flag is cleared internally by driver IC.

Over-Current Protection (OCP)

The FDMF3170 has cycle-by-cycle over current protection. If current exceeds the OCP threshold, HS FET is gated off regardless of PWM command. HS FET cannot be gated on again until the current is less than the OCP threshold with a hysteresis.

Fault flag will be pulled HIGH after 10 cycle-by-cycle OCPs are detected without 3 consecutive normal cycle occurring. Fault flag will clear once 3 consecutive cycle of OCP is NOT detected. Module never shuts down (nor does it disable HDRV/LDRV outputs – i.e., enter internal tri-state) and always responds to PWM commands (but driver will still truncate HS on time when PWM=HIGH and ILIM is detected).

High-Side MOSFET Short Fault

A high-side MOSFET short fault feature is added to the FDMF3170. If a high-side MOSFET short fault is detected, the driver will pull the TMON / FAULT pin

HIGH and continue to respond to PWM commands. Fault flag will clear once HS short is NOT detected or 5 Vcc power re-cycle, EN toggle.

Pre-OVP

The FDMF3170 SPS module monitors V_{OUT} during the power up period. If an abnormally high V_{OUT} is detected during this time, the SPS will gate–on the LS FET until the FAULT clears.

Negative-OCP

The FDMF3170 can detect large negative inductor current and protect the low side MOSFET. Once this negative current threshold is detected, FDMF3170 takes control and truncates LS on-time pulse (LS FET is gated off regardless of PWM command). Driver will return to responding to PWM commands once inductor current falls to -40 A. So, if PWM is still being commanded LOW by controller when inductor falls to -40 A, then LS FET will turn back on. SPS will enter a current limiting (hiccup) mode regulating inductor current from -40 A to -60 A until inductor current relaxes.

Application Information

Decoupling Capacitor for PVCC & VCC

For the supply inputs (PVCC and VCC pins), local decoupling capacitors are required to supply the peak driving current and to reduce noise during switching operation. Use at least 0.68 ~ 1 μ F / 0402 ~ 0603 / X5R ~ X7R multi-layer ceramic capacitors for both power rails. Keep these capacitors close to the PVCC and VCC pins and PGND and AGND copper planes. If they need to be located on the bottom side of board, put through-hole vias on each pads of the decoupling capacitors to connect the capacitor pads on bottom with PVCC and VCC pins on top.

The supply voltage range on PVCC and VCC is 4.5 V ~ 5.5 V, typically 5 V for normal applications.

R-C Filter on VCC

The PVCC pin provides power to the gate drive of the high-side and low-side power MOSFETs. In most cases, PVCC can be connected directly to VCC, which is the pin that provides power to the analog and logic blocks of the driver. To avoid switching noise injection from PVCC into VCC, a filter resistor can be inserted between PVCC and VCC decoupling capacitors.

Recommended filter resistor value range is 0 ~ 10 Ω , typically 0 Ω for most applications.

Bootstrap Circuit

The bootstrap circuit uses a charge storage capacitor (C_{BOOT}). A bootstrap capacitor of 0.1 ~ 0.22 μ F / 0402 ~ 0603 / X5R ~ X7R is usually appropriate for most switching applications. A series bootstrap resistor may be needed for specific applications to lower high-side MOSFET switching speed. The boot resistor is required when the SPS is switching above 15 V V_{IN} ; when it is effective at controlling V_{SW} overshoot. R_{BOOT} value from zero to 6 Ω is typically recommended to reduce

excessive voltage spike and ringing on the SW node. A higher R_{BOOT} value can cause lower efficiency due to high switching loss of high-side MOSFET.

Do not add a capacitor or resistor between the BOOT pin and GND.

IMON (Output) / REFIN (Input)

An externally generated DC voltage from either a controller or other power rail is required to supply REFIN voltage for IMON-REFIN signal. The REFIN voltage must be set to be within the compliant range from 0.6 ~ 2.0 V DC. It is recommended to add a PCB place holder for a small size 1 nF ~ 1 μ F capacitor close to the REFIN pin and AGND to reduce switching noise injection.

It is also recommended to add a small 10 ~ 47 pF capacitor in parallel with the IMON resistor from IMON to REFIN. This capacitor can help reduce switching noise coupling onto the IMON signal. The place of the IMON resistor and cap should be close to the controller, not the SPS to improve the sensing accuracy.

TMON (Output) / FAULT (Output)

A 0.1 nF to 1 nF capacitor, C_{TMON} , can be placed from TMON to AGND and used to minimize switching noise injection onto TMON pin.

An RC low-pass filter with ~ 1 k Ω and ~ 1 nF can be placed on TMON / FAULT pin to AGND to reduce switching noise injection into TMON / FAULT pin.

PCB Layout Guideline

All of the high-current paths; such as VIN, SW, VOUT, and GND coppers; should be short and wide for low parasitic inductance and resistance. This helps achieve a more stable and evenly distributed current flow, along with enhanced heat radiation and system performance.

Input ceramic bypass capacitors must be close to the VIN and PGND pins. This reduces the high-current power loop inductance and the input current ripple induced by the power MOSFET switching operation.

An output inductor should be located close to the FDMF3170 to minimize the power loss due to the SW copper trace. Care should also be taken so the inductor dissipation does not heat the SPS.

PowerTrench[®] MOSFETs are used in the output stage and are effective at minimizing ringing due to fast switching. In most cases, no RC snubber on SW node is required. If a snubber is used, it should be placed close to the SW and PGND pins. The resistor and capacitor of the snubber must be sized properly to not generate excessive heating due to high power dissipation.

Decoupling capacitors on PVCC, VCC, and BOOT capacitors should be placed as close as possible to the PVCC ~ PGND, VCC ~ AGND, and BOOT ~ PHASE pin pairs to ensure clean and stable power supply. Their routing traces should be wide and short to minimize parasitic PCB resistance and inductance.

The board layout should include a placeholder for small-value series boot resistor on BOOT ~ PHASE. The boot-loop size, including series R_{BOOT} and C_{BOOT} , should be as small as possible.

A boot resistor may be required when the SPS is operating above 15 V V_{IN} and it is effective to control the high-side MOSFET turn-on slew rate and SW voltage overshoot. R_{BOOT} can improve noise operating margin in synchronous buck designs that may have noise issues due to ground bounce or high positive and negative V_{SW} ringing. Inserting a boot resistance lowers the SPS module efficiency. Efficiency versus switching noise

must be considered. R_{BOOT} values from 0.5 Ω to 6.0 Ω are typically effective in reducing V_{SW} overshoot.

The VIN and PGND pins handle large current transients with frequency components greater than 100 MHz. If possible, these pins should be connected directly to the VIN and board GND planes. The use of thermal relief traces in series with these pins is not recommended since this adds extra parasitic inductance to the power path. This added inductance in series with either the VIN or PGND pin degrades system noise immunity by increasing positive and negative V_{SW} ringing.

PGND pad and pins should be connected to the GND copper plane with multiple vias for stable grounding. Poor grounding can create a noisy and transient offset voltage level between PGND and AGND. This could lead to faulty operation of gate driver and MOSFETs.

Ringing at the BOOT pin is most effectively controlled by close placement of the boot capacitor. Do not add any additional capacitors between BOOT to PGND. This may lead to excess current flow through the BOOT diode, causing high power dissipation.

Put multiple vias on the VIN and VOUT copper areas to interconnect top, inner, and bottom layers to evenly distribute current flow and heat conduction. Do not put too many vias on the SW copper to avoid extra parasitic inductance and noise on the switching waveform. As long as efficiency and thermal performance are acceptable, place only one SW node copper on the top layer and put no vias on the SW copper to minimize switch node parasitic noise. Vias should be relatively large and of reasonably low inductance. Critical high-frequency components; such as R_{BOOT} , C_{BOOT} , RC snubber, and bypass capacitors; should be located as close to the respective SPS module pins as possible on the top layer of the PCB. If this is not feasible, they can be placed on the board bottom side and their pins connected from bottom to top through a network of low-inductance vias.

ON Semiconductor and  are trademarks of Semiconductor Components Industries, LLC dba ON Semiconductor or its subsidiaries in the United States and/or other countries. ON Semiconductor owns the rights to a number of patents, trademarks, copyrights, trade secrets, and other intellectual property. A listing of ON Semiconductor's product/patent coverage may be accessed at www.onsemi.com/site/pdf/Patent-Marking.pdf. ON Semiconductor reserves the right to make changes without further notice to any products herein. ON Semiconductor makes no warranty, representation or guarantee regarding the suitability of its products for any particular purpose, nor does ON Semiconductor assume any liability arising out of the application or use of any product or circuit, and specifically disclaims any and all liability, including without limitation special, consequential or incidental damages. Buyer is responsible for its products and applications using ON Semiconductor products, including compliance with all laws, regulations and safety requirements or standards, regardless of any support or applications information provided by ON Semiconductor. "Typical" parameters which may be provided in ON Semiconductor data sheets and/or specifications can and do vary in different applications and actual performance may vary over time. All operating parameters, including "Typicals" must be validated for each customer application by customer's technical experts. ON Semiconductor does not convey any license under its patent rights nor the rights of others. ON Semiconductor products are not designed, intended, or authorized for use as a critical component in life support systems or any FDA Class 3 medical devices or medical devices with a same or similar classification in a foreign jurisdiction or any devices intended for implantation in the human body. Should Buyer purchase or use ON Semiconductor products for any such unintended or unauthorized application, Buyer shall indemnify and hold ON Semiconductor and its officers, employees, subsidiaries, affiliates, and distributors harmless against all claims, costs, damages, and expenses, and reasonable attorney fees arising out of, directly or indirectly, any claim of personal injury or death associated with such unintended or unauthorized use, even if such claim alleges that ON Semiconductor was negligent regarding the design or manufacture of the part. ON Semiconductor is an Equal Opportunity/Affirmative Action Employer. This literature is subject to all applicable copyright laws and is not for resale in any manner.

PUBLICATION ORDERING INFORMATION

LITERATURE FULFILLMENT:

Literature Distribution Center for ON Semiconductor
19521 E. 32nd Pkwy, Aurora, Colorado 80011 USA
Phone: 303-675-2175 or 800-344-3860 Toll Free USA/Canada
Fax: 303-675-2176 or 800-344-3867 Toll Free USA/Canada
Email: orderlit@onsemi.com

N. American Technical Support: 800-282-9855 Toll Free
USA/Canada
Europe, Middle East and Africa Technical Support:
Phone: 421 33 790 2910
Japan Customer Focus Center
Phone: 81-3-5817-1050

ON Semiconductor Website: www.onsemi.com
Order Literature: <http://www.onsemi.com/orderlit>
For additional information, please contact your local
Sales Representative

Компания «Океан Электроники» предлагает заключение долгосрочных отношений при поставках импортных электронных компонентов на взаимовыгодных условиях!

Наши преимущества:

- Поставка оригинальных импортных электронных компонентов напрямую с производств Америки, Европы и Азии, а так же с крупнейших складов мира;
- Широкая линейка поставок активных и пассивных импортных электронных компонентов (более 30 млн. наименований);
- Поставка сложных, дефицитных, либо снятых с производства позиций;
- Оперативные сроки поставки под заказ (от 5 рабочих дней);
- Экспресс доставка в любую точку России;
- Помощь Конструкторского Отдела и консультации квалифицированных инженеров;
- Техническая поддержка проекта, помощь в подборе аналогов, поставка прототипов;
- Поставка электронных компонентов под контролем ВП;
- Система менеджмента качества сертифицирована по Международному стандарту ISO 9001;
- При необходимости вся продукция военного и аэрокосмического назначения проходит испытания и сертификацию в лаборатории (по согласованию с заказчиком);
- Поставка специализированных компонентов военного и аэрокосмического уровня качества (Xilinx, Altera, Analog Devices, Intersil, Interpoint, Microsemi, Actel, Aeroflex, Peregrine, VPT, Syfer, Eurofarad, Texas Instruments, MS Kennedy, Miteq, Cobham, E2V, MA-COM, Hittite, Mini-Circuits, General Dynamics и др.);

Компания «Океан Электроники» является официальным дистрибьютором и эксклюзивным представителем в России одного из крупнейших производителей разъемов военного и аэрокосмического назначения «JONHON», а так же официальным дистрибьютором и эксклюзивным представителем в России производителя высокотехнологичных и надежных решений для передачи СВЧ сигналов «FORSTAR».



JONHON

«JONHON» (основан в 1970 г.)

Разъемы специального, военного и аэрокосмического назначения:

(Применяются в военной, авиационной, аэрокосмической, морской, железнодорожной, горно- и нефтедобывающей отраслях промышленности)

«FORSTAR» (основан в 1998 г.)

ВЧ соединители, коаксиальные кабели, кабельные сборки и микроволновые компоненты:

(Применяются в телекоммуникациях гражданского и специального назначения, в средствах связи, РЛС, а так же военной, авиационной и аэрокосмической отраслях промышленности).



Телефон: 8 (812) 309-75-97 (многоканальный)

Факс: 8 (812) 320-03-32

Электронная почта: ocean@oceanchips.ru

Web: <http://oceanchips.ru/>

Адрес: 198099, г. Санкт-Петербург, ул. Калинина, д. 2, корп. 4, лит. А