

## HF/VHF/UHF RF power N-channel MOSFET

Datasheet - production data

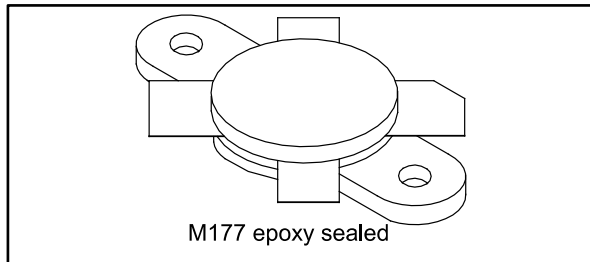

**Figure 1: Pin connection**

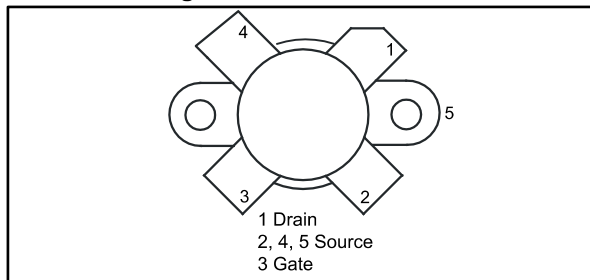

### Features

- High power capability
- $P_{OUT} = 350$  W min. with 22 dB gain @ 30 MHz
- $P_{SAT} = 450$  W
- Low  $R_{DS(on)}$
- Thermally enhanced packing for lower junction temperatures
- Gold metallization
- Excellent thermal stability
- Common source configuration

### Description

The SD2943 is a gold metallized N-channel MOS field-effect RF power transistor. It is used for 50 V DC large signal applications up to 150 MHz. The SD2943 offers a 20% higher power saturation than the SD2933, and is ideal for ISM applications where reliability and ruggedness are critical factors.

**Table 1: Device summary**

Order code	Marking	Package	Packing
SD2943W	SD2943 <sup>(1)</sup>	M177	Plastic tray

#### Notes:

<sup>(1)</sup>For more details please refer to [Section 6: "Marking, packing and shipping specifications"](#).

---

# Contents

- 1 Electrical data ..... 3**
  - 1.1 Maximum ratings ..... 3
  - 1.2 Thermal data ..... 3
- 2 Electrical characteristics ..... 4**
- 3 Impedance data ..... 5**
- 4 Typical performance ..... 6**
- 5 Test circuit (175 MHz)..... 8**
- 6 Marking, packing and shipping specifications..... 10**
- 7 Package information ..... 11**
  - 7.1 M177 (.550 DIA 4L NHERM WFLG) package information ..... 11
- 8 Revision history ..... 12**



# 1 Electrical data

## 1.1 Maximum ratings

$T_{CASE} = 25\text{ °C}$

Table 2: Absolute maximum ratings

Symbol	Parameter	Value	Unit
$V_{(BR)DSS}^{(1)}$	Drain source voltage	130	V
$V_{DGR}$	Drain-gate voltage ( $R_{GS} = 1\text{ M}\Omega$ )	130	V
$V_{GS}$	Gate-source voltage	$\pm 40$	V
$I_D$	Drain current	40	A
$P_{DISS}$	Power dissipation	648	W
$T_J$	Max. operating junction temperature	+200	°C
$E_{AS}$	Avalanche energy, single pulse ( $I_D = 53\text{ A}$ , $800\text{ }\mu\text{H}$ coil)	1100	mJ
$T_{STG}$	Storage temperature	-65 to +150	°C

**Notes:**

<sup>(1)</sup> $T_J = 150\text{ °C}$

## 1.2 Thermal data

Table 3: Thermal data

Symbol	Parameter	Value	Unit
$R_{thJC}$	Junction-to-case thermal resistance	0.27	°C/W

## 2 Electrical characteristics

$T_{CASE} = 25\text{ °C}$

**Table 4: Static**

Symbol	Test conditions		Min.	Typ.	Max.	Unit
$V_{(BR)DSS}^{(1)}$	$V_{GS} = 0\text{ V}$	$I_{DS} = 200\text{ mA}$	130			V
$I_{DSS}$	$V_{GS} = 0\text{ V}$	$V_{DS} = 50\text{ V}$			200	$\mu\text{A}$
$I_{GSS}$	$V_{GS} = 20\text{ V}$	$V_{DS} = 0\text{ V}$			500	nA
$V_{GS(Q)}$	$V_{DS} = 10\text{ V}$	$I_D = 250\text{ mA}$	2		4	V
$V_{DS(ON)}$	$V_{GS} = 10\text{ V}$	$I_D = 20\text{ A}$			2	V
$G_{FS}$	$V_{DS} = 10\text{ V}$	$I_D = 10\text{ A}$	10			mho
$C_{ISS}$	$V_{GS} = 0\text{ V}$	$V_{DS} = 50\text{ V}$		830		pF
$C_{OSS}$	$V_{GS} = 0\text{ V}$	$V_{DS} = 50\text{ V}$		470		pF
$C_{RSS}$	$V_{GS} = 0\text{ V}$	$V_{DS} = 50\text{ V}$		35		pF

**Notes:**

<sup>(1)</sup> $T_J = 150\text{ °C}$

**Table 5: Dynamic**

Symbol	Test conditions		Min.	Typ.	Max.	Unit
$P_{OUT}$	$V_{DD} = 50\text{ V}$	$I_{DQ} = 250\text{ mA}$ $f = 30\text{ MHz}$	350	450		W
$G_{PS}$	$V_{DD} = 50\text{ V}$	$I_{DQ} = 250\text{ mA}$ $P_{OUT} = 350\text{ W}$ $f = 30\text{ MHz}$	22	25		dB
$\eta_D$	$V_{DD} = 50\text{ V}$	$I_{DQ} = 250\text{ mA}$ $P_{OUT} = 350\text{ W}$ $f = 30\text{ MHz}$	60	65		%
Load mismatch	$V_{DD} = 50\text{ V}$	$I_{DQ} = 250\text{ mA}$ $P_{OUT} = 350\text{ W}$ $f = 30\text{ MHz}$ All phase angles	3:1			VSWR

**Table 6:  $G_{FS}$  sorts**

Symbol	Value
A	10 to 10.99
B	11 to 11.99
C	12 to 12.99
D	13 to 13.99
E	14 to 14.99
F	15 to 15.99
G	16 to 16.99
H	17 to 18

### 3 Impedance data

Figure 2: Impedance data

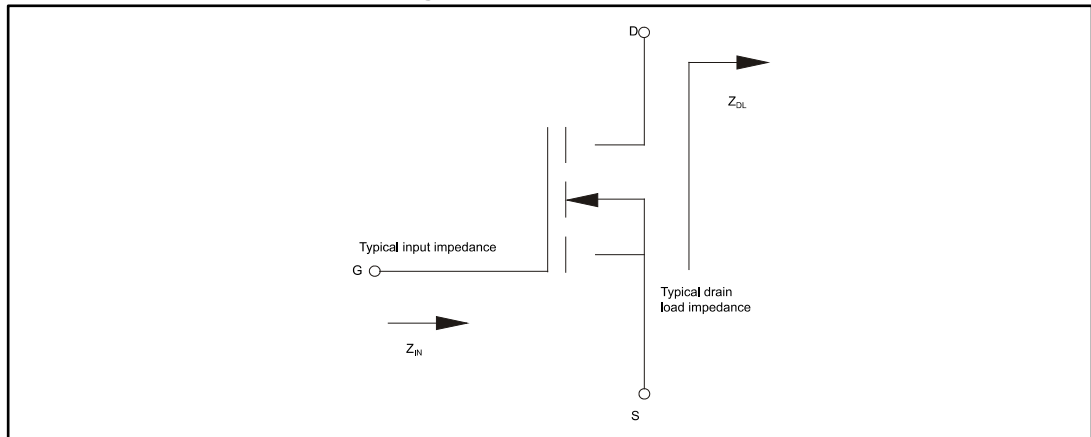

Table 7: Impedance data

f	$Z_{IN}(\Omega)$	$Z_{DL}(\Omega)$
30 MHz	$1.3 - j 2.9$	$3.1 + j 2.3$
108 MHz	$1.4 - j 2.4$	$1.9 + j 1.4$
175 MHz	$1.4 - j 2.2$	$1.7 + j 1.6$

## 4 Typical performance

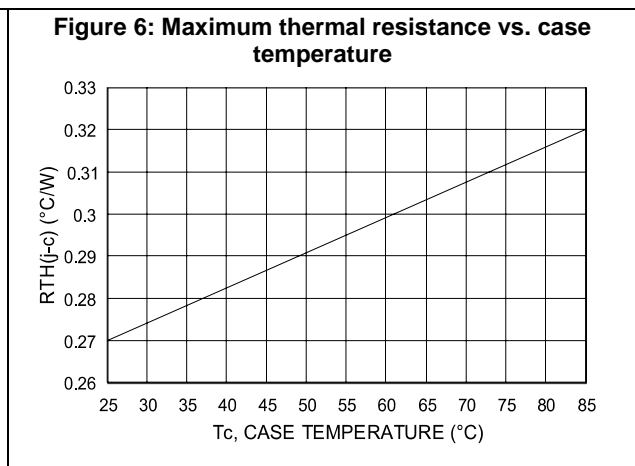
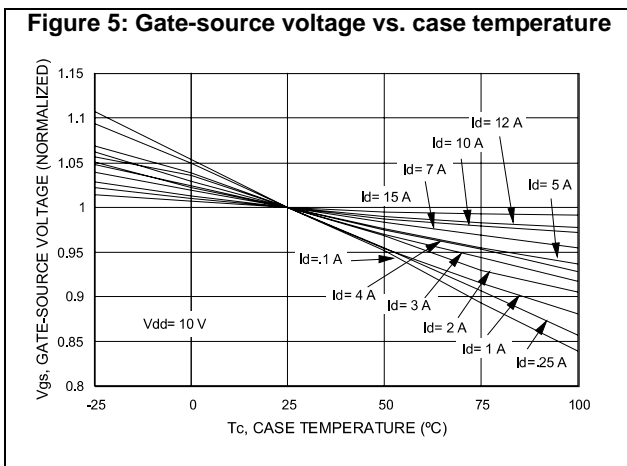
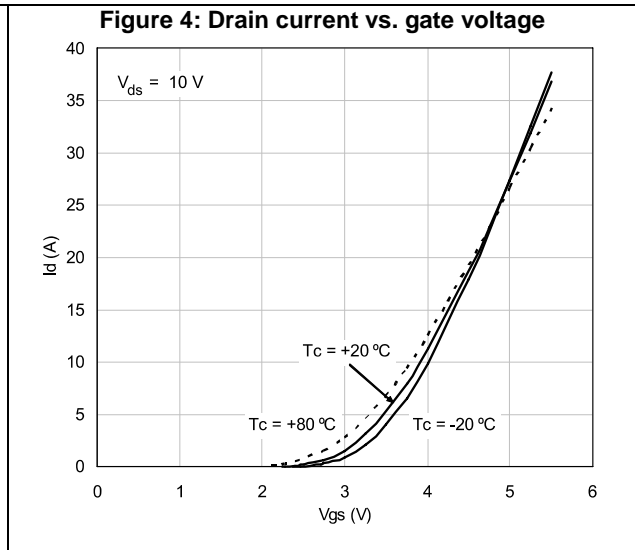
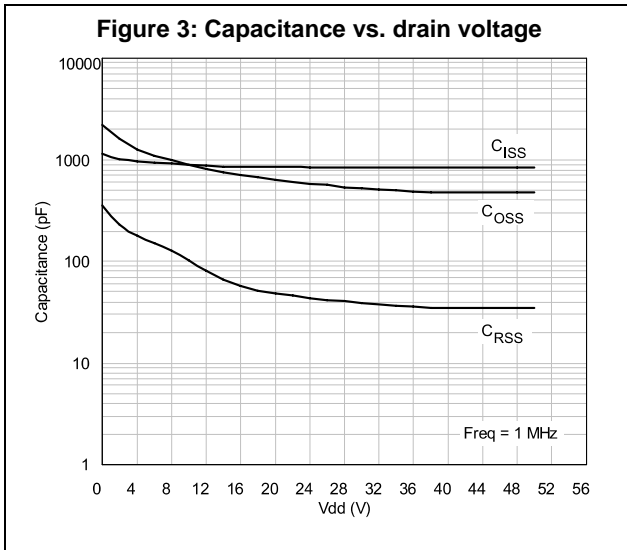

Figure 7: Output power vs. input power

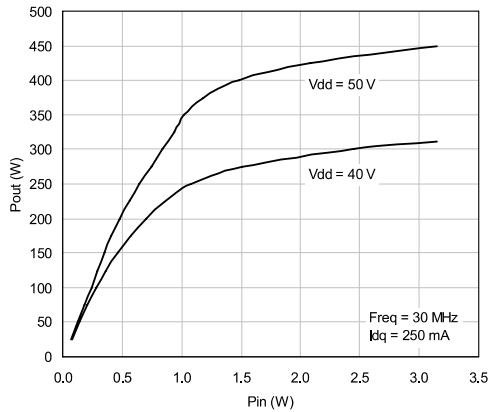

Figure 8: Output power vs. input power (at different temperature)

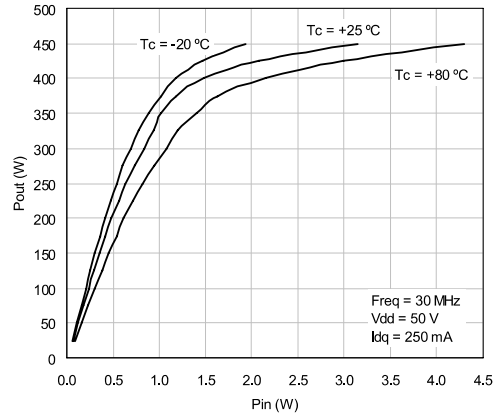

Figure 9: Power gain vs. output power

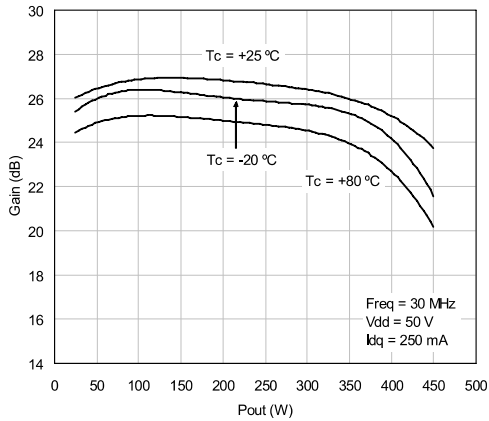

Figure 10: Efficiency vs. output power

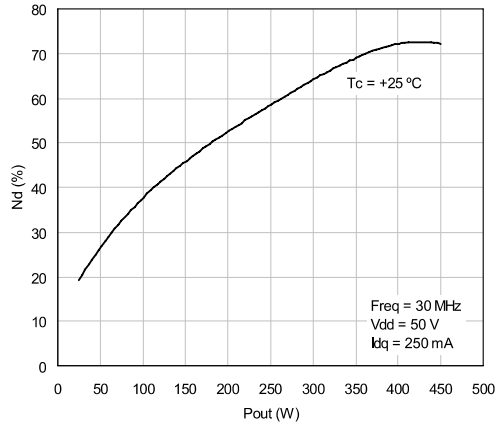

Figure 11: Output power vs. supply voltage

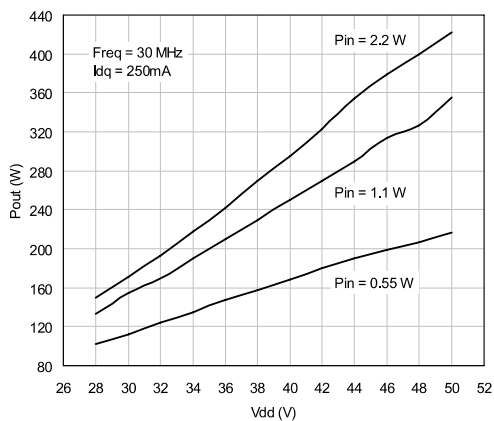
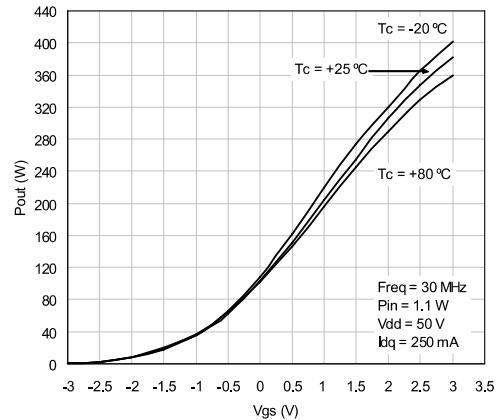
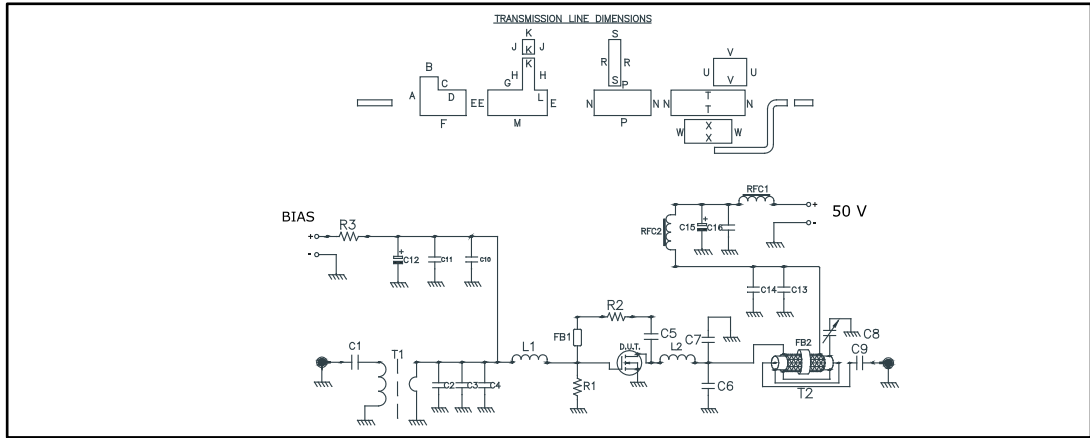

Figure 12: Output power vs. gate voltage



## 5 Test circuit (175 MHz)

Figure 13: 30 MHz test circuit schematic



Dimensions at component symbols are references for component placement. Gap between ground and transmission files are 0.056[1.42] (typ.). Transmission line is not 1:1 scale. Input and output transmission line are 50 Ω.

Table 8: 30 MHz test circuit part list

Component	Description
C1, C9	0.01 μF / 500 V surface mount ceramic chip capacitor
C2, C3	750 pF ATC 700B surface mount ceramic chip capacitor
C4	300 pF ATC 700B surface mount ceramic chip capacitor
C5, C10, C11, C14, C16	10000 pF ATC 200B surface mount ceramic chip capacitor
C6	510 pF ATC 700B surface mount ceramic chip capacitor
C7	300 pF ATC 700B surface mount ceramic chip capacitor
C8	175-680 pF type 46 standard trimmer capacitor
C12	47 μF / 63 V aluminum electrolytic radial lead capacitor
C13	1200 pF ATC 700B surface mount ceramic chip capacitor
C15	100 μF / 63 V aluminum electrolytic radial lead capacitor
R1, R3	1 kΩ 1 W surface mount chip resistor
R2	560 Ω 2 W wire-wound axil lead resistor
T1	HF 2-30 MHz surface mount 9:1 transformer
T2	RG - 142B/U 50 Ω coaxial cable OD = 0.165[4.18] L 15"[381.00] covered with 15"[381.00] tinned copper tubular brand 13/65" [5.1] width
L1	1 3/4 turn air-wound 16 AWG ID = 0.219 [5.56] poly-coated magnet wire
L2	1 3/4 turn air-wound 12 AWG ID = 0.250 [6.34] bus bar wire
RFC1, RFC2	3 turns 14 AWG wire through fair rite toroid
FB1	Surface mount shield bead



Component	Description
FB2	Toroid
PCB	ULTRALAM 2000. 0.030" THK, $\epsilon_r = 2.55$ , 2 Oz ED CU both sides

Figure 14: 30 MHz test circuit

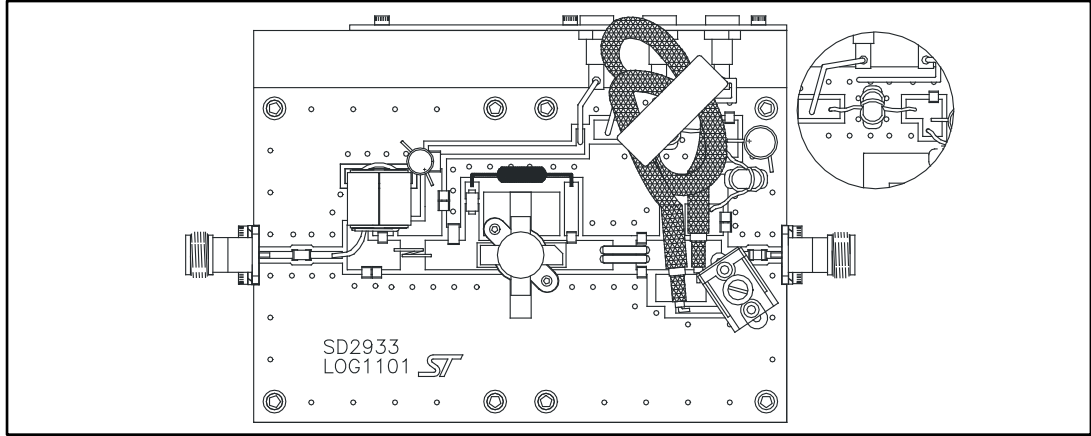

Both the SD2933 and the SD2943 device use the same PCB.

Figure 15: 30 MHz test circuit photomaster

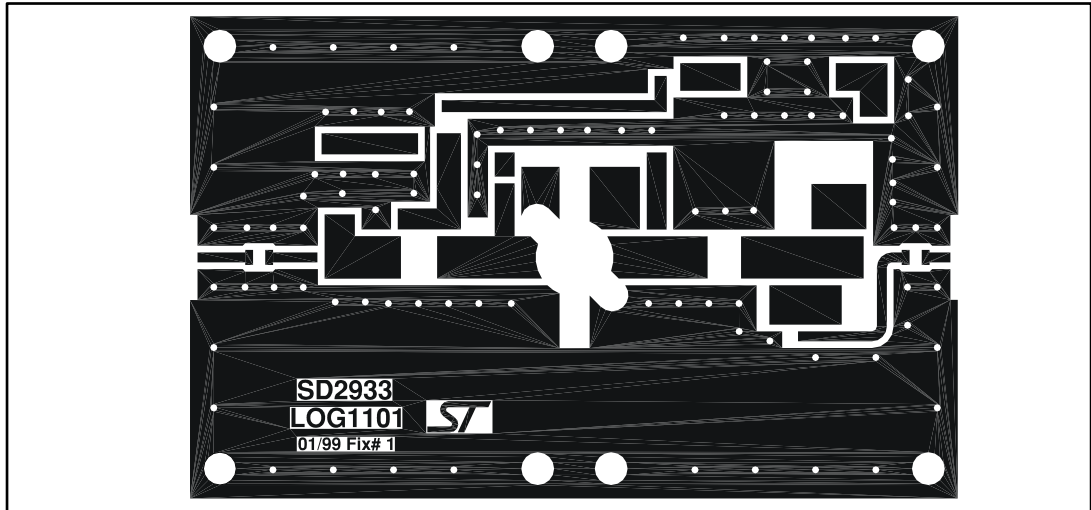

## 6 Marking, packing and shipping specifications

Table 9: Packing and shipping specifications

Order code	Packing	Pieces per tray	Dry pack humidity	GFS code	Lot code
SD2943W	Plastic tray	25	< 10%	Not mixed	Not mixed

Figure 16: SD2943 marking layout

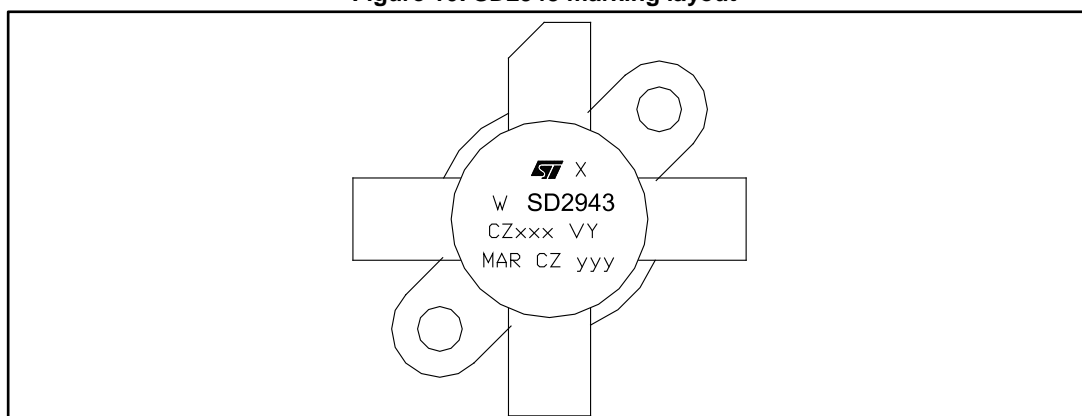

Table 10: Marking specifications

Symbol	Description
W	Wafer process code
X	GFS sort
CZ	Assembly plant
xxx	Last 3 digits of diffusion lot
VY	Diffusion plant
MAR	Country of origin
CZ	Test and finishing plant
y	Assembly year
yy	Assembly week

## 7 Package information

In order to meet environmental requirements, ST offers these devices in different grades of ECOPACK® packages, depending on their level of environmental compliance. ECOPACK® specifications, grade definitions and product status are available at: [www.st.com](http://www.st.com). ECOPACK® is an ST trademark.

### 7.1 M177 (.550 DIA 4L NHERM WFLG) package information

Figure 17: M177 (.550 DIA 4L N/HERM W/FLG) package outline

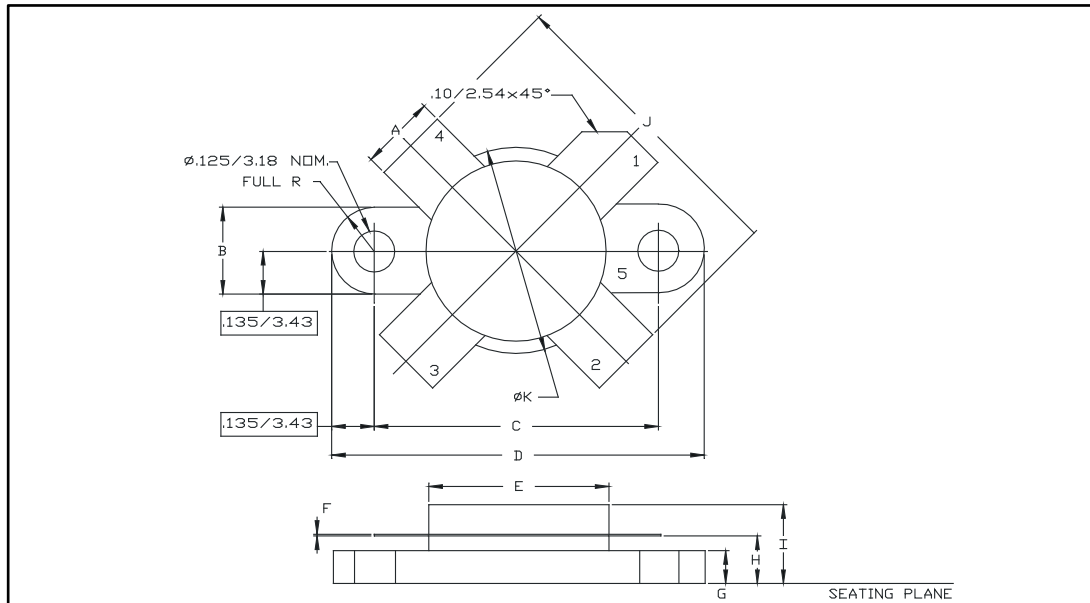

Table 11: M177 (.550 DIA 4L N/HERM W/FLG) package mechanical data

Dim.	mm		
	Min.	Typ.	Max.
A	5.72		5.97
B	6.73		6.96
C	21.84		22.10
D	28.70		28.96
E	13.84		14.10
F	0.08		0.18
G	2.49		2.74
H	3.81		4.32
I			7.11
J	27.43		28.45
K	15.88		16.13

## 8 Revision history

Table 12: Document revision history

Date	Revision	Changes
18-Oct-2005	1	First issue.
04-Jan-2006	2	Complete version.
24-Aug-2011	3	Inserted <i>Chapter 7: Marking, packing and shipping specifications</i> . Minor text changes.
10-Aug-2015	4	Updated <i>Table 2.: Absolute maximum rating</i> . Minor text changes.
02-Dec-2016	5	Updated <i>Table 2: "Absolute maximum ratings"</i> . Minor text changes.

**IMPORTANT NOTICE – PLEASE READ CAREFULLY**

STMicroelectronics NV and its subsidiaries ("ST") reserve the right to make changes, corrections, enhancements, modifications, and improvements to ST products and/or to this document at any time without notice. Purchasers should obtain the latest relevant information on ST products before placing orders. ST products are sold pursuant to ST's terms and conditions of sale in place at the time of order acknowledgement.

Purchasers are solely responsible for the choice, selection, and use of ST products and ST assumes no liability for application assistance or the design of Purchasers' products.

No license, express or implied, to any intellectual property right is granted by ST herein.

Resale of ST products with provisions different from the information set forth herein shall void any warranty granted by ST for such product.

ST and the ST logo are trademarks of ST. All other product or service names are the property of their respective owners.

Information in this document supersedes and replaces information previously supplied in any prior versions of this document.

© 2016 STMicroelectronics – All rights reserved

Компания «Океан Электроники» предлагает заключение долгосрочных отношений при поставках импортных электронных компонентов на взаимовыгодных условиях!

Наши преимущества:

- Поставка оригинальных импортных электронных компонентов напрямую с производств Америки, Европы и Азии, а так же с крупнейших складов мира;
- Широкая линейка поставок активных и пассивных импортных электронных компонентов (более 30 млн. наименований);
- Поставка сложных, дефицитных, либо снятых с производства позиций;
- Оперативные сроки поставки под заказ (от 5 рабочих дней);
- Экспресс доставка в любую точку России;
- Помощь Конструкторского Отдела и консультации квалифицированных инженеров;
- Техническая поддержка проекта, помощь в подборе аналогов, поставка прототипов;
- Поставка электронных компонентов под контролем ВП;
- Система менеджмента качества сертифицирована по Международному стандарту ISO 9001;
- При необходимости вся продукция военного и аэрокосмического назначения проходит испытания и сертификацию в лаборатории (по согласованию с заказчиком);
- Поставка специализированных компонентов военного и аэрокосмического уровня качества (Xilinx, Altera, Analog Devices, Intersil, Interpoint, Microsemi, Actel, Aeroflex, Peregrine, VPT, Syfer, Eurofarad, Texas Instruments, MS Kennedy, Miteq, Cobham, E2V, MA-COM, Hittite, Mini-Circuits, General Dynamics и др.);

Компания «Океан Электроники» является официальным дистрибьютором и эксклюзивным представителем в России одного из крупнейших производителей разъемов военного и аэрокосмического назначения «JONHON», а так же официальным дистрибьютором и эксклюзивным представителем в России производителя высокотехнологичных и надежных решений для передачи СВЧ сигналов «FORSTAR».



## JONHON

«JONHON» (основан в 1970 г.)

Разъемы специального, военного и аэрокосмического назначения:

(Применяются в военной, авиационной, аэрокосмической, морской, железнодорожной, горно- и нефтедобывающей отраслях промышленности)

«FORSTAR» (основан в 1998 г.)

ВЧ соединители, коаксиальные кабели, кабельные сборки и микроволновые компоненты:

(Применяются в телекоммуникациях гражданского и специального назначения, в средствах связи, РЛС, а так же военной, авиационной и аэрокосмической отраслях промышленности).



Телефон: 8 (812) 309-75-97 (многоканальный)

Факс: 8 (812) 320-03-32

Электронная почта: [ocean@oceanchips.ru](mailto:ocean@oceanchips.ru)

Web: <http://oceanchips.ru/>

Адрес: 198099, г. Санкт-Петербург, ул. Калинина, д. 2, корп. 4, лит. А