



Side Actuated



Top Actuated



End Actuated



4 pt. PC Board Mount

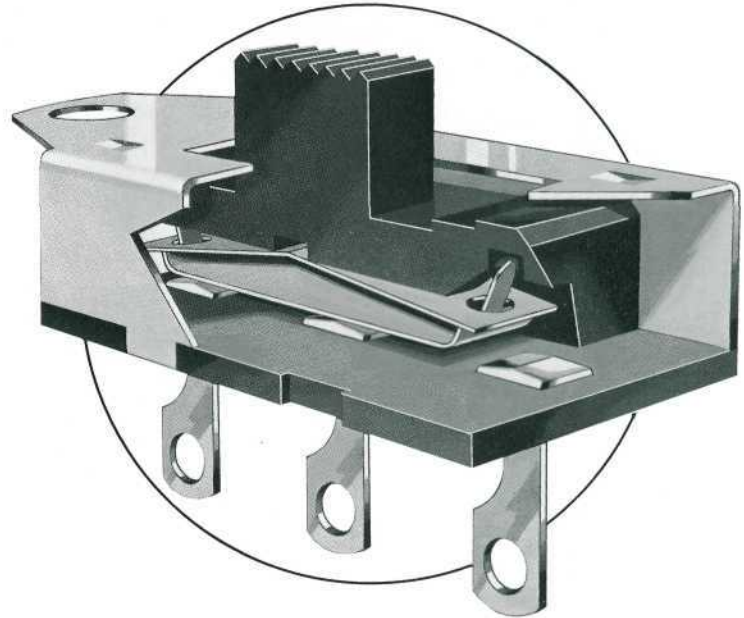

Features:

- One through four poles
- Two through five positions
- For switching up to 8.5 amps at 125 volts ac
- Detent or spring return
- Panel or PC board mount
- Top, side, or end actuation
- Solder, solderless, or wire wrap termination
- U.L. recognized, C.S.A. listed

Slide switches became popular in America with industrial expansion after World War I. The "standard" two position switch was designed for chassis mount on two 1.125-inch centered mounting holes. Terminals were designed for convenience in hand soldering. Actuation was with a trigger extending out the switch top, and generally switches were constructed for switching up to 3.0 amps at 125 volts ac. With the development of densely packed printed circuit boards, new materials, and new innovative requirements, design engineers found needs for switching higher and lower currents and voltages in smaller switch packages having a wide variety of terminations as well as actuation from switch sides, ends, and tops.

In response to industry's need for miniaturization, CW first developed its miniature "Swidget"® line of slide switches; and for printed circuit board applications, its "Sydwynders"®. CW's line of miniature Swidgets® now has capability of switching currents up to 8.5 amps, four poles concurrently and five posi-

tions consecutively. Switching can be by toggle, front, side, and top actuating knobs. Terminals for solder, printed circuit board, wire wrap, and solderless termination are also available.

This vast variety of switch types and options has increased and multiplied the types of equipment into which CW switches have been designed and are used...with time-proven reliability at moderate prices. From early applications in toys, kits, and games, our switches are now used everywhere...from low voltage, low current to heavy duty switching...from calculators, computers, and sensitive instruments to hair blowers, automobiles, and refrigerators...and TV, home appliances, and aerospace devices, too.

CW's switch parts and assemblies are manufactured in CW's fully integrated manufacturing facilities. All processes are performed and controlled by CW's highly trained and technically competent personnel.



MINIATURE SLIDE SHIFT SELECTION GUIDE



Top-Actuated Panel Mount

Model	Circuit	Page No.
GF-123	spst detent	5
GF-124	spdt detent	5
G-134	spst spring return	5
G-133	spdt spring return	5
G-223	spst spring return (push)	6
GF-125	dpst detent	6
GF-126	dpdt detent	6
GF-161	3pdt detent	7
G-127	sp3pos detent	7
G-173	sp3pos spring return	8
G-128	dp3pos detent	7
G-175	dp3pos spring return	8
G-168	3p3pos detent	9
G-169	4p3pos detent	9
G-140	sp4pos detent	10
G-141	dp4pos detent	10



**Top-Actuated
4-Point PC Board Mount**

Model	Circuit	Page No.
GPF-124	spdt detent	13
GP-132	spdt spring return	13
GPF-126	dpdt detent	13



**Side-Actuated
4-Point PC Board Mount**

Model	Circuit	Page No.
GPI-151	spdt detent	14
GPI-152	dpdt detent	14
GPI-153	sp3pos detent	14
GPI-154	dp3pos detent	14



Side-Actuated Panel Mount

Model	Circuit	Page No.
GI-151	spdt detent	11
GI-152	dpdt detent	11
GF-165	3pdt detent	12
GI-153	sp3pos detent	11
GI-154	dp3pos detent	11
GI-158	sp4pos detent	12
GI-159	dp4pos detent	12
GI-163	dp5pos detent	13



**End-Actuated
PC Board Mount**

Model	Circuit	Page No.
G-133 PCE	spdt spring return	14

PERFORMANCE STANDARDS

CW switches are designed to perform to the standards listed when operated within ambient conditions detailed below:

Operating temperature—104°C maximum, -10°C minimum.

Relative humidity—Switches will be operable and insulation resistance shall be greater than 100 megohms if allowed to dry for 100 hours at room temperature of 25°C and after exposure for one hour in an atmosphere having 95% relative humidity and a temperature of 50°C.

High voltage breakdown—Minimum of 1000 volts rms 60 Hz for one minute between parts of opposite polarity.

Contact resistance—Less than 0.01 ohm at 20 milliamperes dc.

Life cycling (no load)—Switches will be operative after 10,000 (minimum) cycles at the rate of 10 cycles per minute.

Life cycling (load)—Switches will be operative after 6000 (minimum) cycles at the rate of 10 cycles per minute at rated load.

CARE IN SWITCH INSTALLATION

CW switches will perform properly if they are installed and used properly. Causes for failure often encountered in the field that are the responsibility of the user are:

1. Removal of factory applied lubricants from switch contacts and moving parts.
2. Introduction of foreign material into switching mechanism...

MATERIALS OF CONSTRUCTION

Buttons—Black type 6/6 nylon.

Housings—Cold-rolled steel.

Housing plating—4-point PC board mount switches—electro-tin; others—zinc followed by clear chromate.

Moving contact—Copper or copper alloy.

Moving contact plating—Silver is standard. Gold (30 microinches of gold over 50 microinches of nickel) is available. Other gold thicknesses are available if your quantities are sufficient.

Moving contact spring—Phosphor bronze or beryllium copper.

Terminals—Copper.

Terminal plating—Silver is standard. Gold (30 microinches over 50 microinches of nickel) on many popular types is available.

Terminal board—NEMA Grade XP phenolic laminate.

(Other materials to suit your application are available if volume is sufficient. Consult factory.)

3. Flux, solder, cleaning materials, potting compounds.

4. Restriction of movement of switch button.

5. Excessive heat often introduced while soldering.

6. Switching loads in excess of rating.

Manufacturing Engineers are cautioned to avoid misusing switches and resultant switch failures.

U.L. AND C.S.A.

CW test laboratories are fully equipped to monitor and test CW switches to U.L. and C.S.A. published standards. Most CW switches are listed by these agencies as having conformed to those standards in tests applied on a continuing basis. A record of types of CW switches listed is retained in U.L. File Number E-9556 and in C.S.A. File Number LR20985.

CW PATENTS

CW Engineers are constantly trying to upgrade the quality and cost effectiveness of our switches. Often this results in new inventions. Switch products shown in this catalog may be covered by one or more of the following U.S. patents:

3,270,149	3,993,881
3,271,535	4,404,437
3,311,719	4,128,745
3,461,252	4,410,232

Other patent applications are pending.

HOW TO ORDER

Specify CW part number by referencing drawing that shows switch of your choice. If switch you require differs from drawing, specify differences from options available.

AVAILABLE OPTIONS

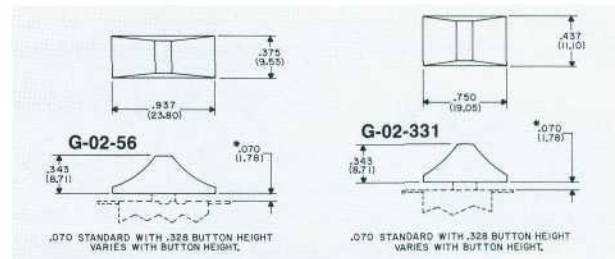

“Toppers”—Shown are toppers that can change your panel appearance and product styling.

Terminals—CW switches can be terminated by hand solder, PC board, wire-wrap, or receptacle. See page 15 for terminal options.

Solder Shields—For hand-soldered terminations or for added protection against flux, solder and foreign materials, request .002” thick vulcanized fiber shield shipped separately or assembled to switch terminals. On single pole switches, solder shields are available for switches having “IN LINE” terminals only.

Hot Stamping—Functional or decorative marking of your choice can be imprinted on the “Topper” with CW’s “in-house” facilities.

Colors—CW stores molding powders in many colors. “Toppers” and buttons are available in a variety of colors if your quantity is sufficient.

TOP-ACTUATED PANEL MOUNT MINIATURE SWITCHES

GF-123 Single Pole/Single Throw (with detent)
GF-124 Single Pole/Double Throw (with detent)

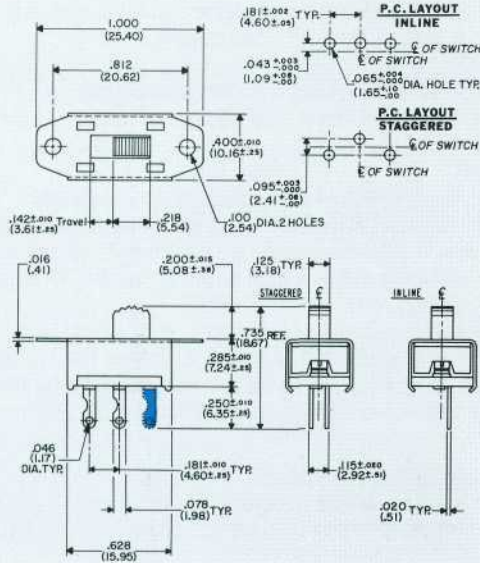

NOTE: SPST versions have one end terminal (shown in blue) removed. Provision for varying current and voltage rating is made by changing internal contact materials.

TYPE	ELECTRICAL RATING	LISTING*
GF-123	0.5 A at 125 Vac/Vdc	U.L. & C.S.A.
GF-123-3	3.0 A ac, 0.5 A at 125 Vdc	U.L. & C.S.A.
GF-123-8.5	8.5 A ac, 0.5 A at 125 Vdc	U.L. & C.S.A.
GF-124	0.5 A at 125 Vac/Vdc	U.L. & C.S.A.
GF-124-3	3.0 A ac, 0.5 A at 125 Vdc	U.L. & C.S.A.
GF-124-8.5	8.5 A ac, 0.5 A at 125 Vdc	U.L. & C.S.A.

*Specify C.S.A. listing, if required.

FOR TOPPERS, BUTTONS, MOUNTINGS, TERMINALS, AND SOLDER SHIELD, SEE BELOW.

ACTUATOR KNOB

Decorative aluminum sleeved actuating knob is available. Specify GB-123 or GB-124 with appropriate suffix indicating your current requirements. .453" knob height shown is standard. Also available in heights of .162" (4.11 mm), .200" (5.08 mm), .473" (12.01 mm), .569" (14.27 mm), and .709" (18.01 mm).

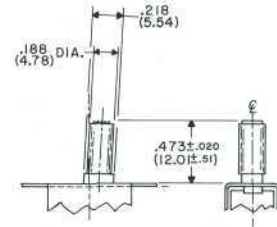

G-134 Single Pole/Single Throw (spring return)
G-133 Single Pole/Double Throw (spring return)

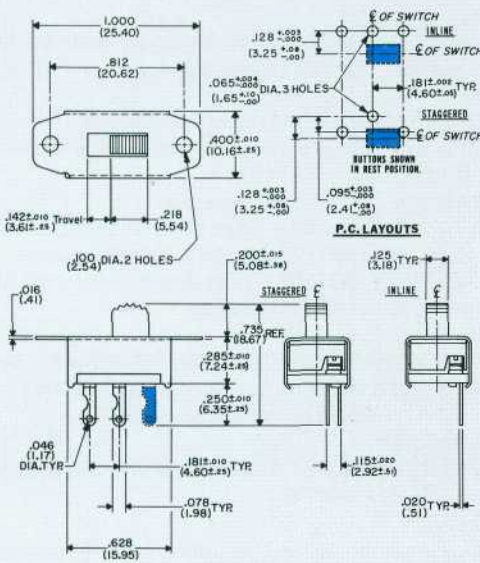

NOTE: SPST versions have one end terminal (shown in blue) removed. Provision for varying current and voltage rating is made by changing internal contact materials.

TYPE	ELECTRICAL RATING	LISTING*
G-134	0.5 A at 125 Vac/Vdc	U.L. & C.S.A.
G-134-3	3.0 A ac, 0.5 A at 125 Vdc	U.L. & C.S.A.
G-134-8.5	8.5 A ac, 0.5 A at 125 Vdc	U.L. & C.S.A.
G-133	0.5 A at 125 Vac/Vdc	U.L. & C.S.A.
G-133-3	3.0 A ac, 0.5 A at 125 Vdc	U.L. & C.S.A.
G-133-8.5	8.5 A ac, 0.5 A at 125 Vdc	U.L. & C.S.A.

*Specify C.S.A. listing, if required.

TOPPERS

Control panel styling and appearance can be changed by adding an auxiliary "Topper". See page 4.

BUTTONS

.200" (5.08 mm) button height shown is standard. Other heights available are .125" (3.18 mm), .328" (8.33 mm), and .453" (11.51 mm).

MOUNTING

PANEL—Two .100" diameter holes on .812" centers. 4-40 extruded and tapped mounting holes are also available.

PRINTED CIRCUIT BOARD—Plug directly into printed circuit board having hole pattern mating with your switch terminals. Standard single pole terminal orientation is IN-LINE. For greater switch stability on your PC board before soldering, specify STAGGERED terminals.

TERMINALS

Standard is solder terminal G-20-28 as shown. For PC applications, we suggest G-20-18, but you may specify the terminal of your choice from those on page 15.

SOLDER SHIELD

Vulcanized fiber shield .020" thick may be shipped assembled or separate as requested.

TOP-ACTUATED PANEL MOUNT MINIATURE SWITCHES

G-223 Single Pole/Single Throw (momentary contact)



ELECTRICAL RATING

.25 A at 125 Vac/Vdc

LISTING

U.L.

TOPPERS

Control panel styling and appearance can be changed by adding an auxiliary "Topper". See page 4.

BUTTONS

.200" (5.08 mm) button height shown is standard. Other heights available are .328" (8.33 mm), .453" (11.51 mm), and .438" (11.13 mm).

MOUNTING

PANEL—Two .100" diameter holes on .812" centers.
PRINTED CIRCUIT BOARD—Plug directly into board having hole pattern shown for standard switch with two terminals. Also shown is optional four-terminal version, for greater PC board stability.

TERMINALS

Standard is solder terminal G-20-28 as shown. For PC applications, we suggest G-20-18, but you may specify the terminal of your choice from those on page 15.

Switch action: Force on actuating knob *toward mounting surface* makes electrical contact; removal of force allows switch contacts to open. Standard version has two terminals. Also available with four terminals (additional terminals shown in blue), providing four-corner support for PC board mounting.

GF-125 Double Pole/Single Throw (with detent) GF-126 Double Pole/Double Throw (with detent)



DPST versions have two end terminals (shown in blue) removed.

LOGIC SWITCH GF-126-500

Same as GF-126, except the button of this switch is sliced in half so that each pole can be actuated independently or simultaneously with the other pole, as desired. Four different conditions of a circuit can be attained. Included is one black button half and one white button half.



TYPE

GF-125

ELECTRICAL RATING

0.5 A at 125 Vac/Vdc

LISTING*

U.L. & C.S.A.

GF-125-3

3.0 A ac, 0.5 A at 125 Vdc

U.L. & C.S.A.

GF-125-8.5

8.5 A ac, 0.5 A at 125 Vdc

U.L. & C.S.A.

GF-126

0.5 A at 125 Vac/Vdc

U.L. & C.S.A.

GF-126-3

3.0 A ac, 0.5 A at 125 Vdc

U.L. & C.S.A.

GF-126-8.5

8.5 A ac, 0.5 A at 125 Vdc

U.L. & C.S.A.

GF-126-500

0.5 A at 125 Vac/Vdc

U.L. & C.S.A.

*Specify C.S.A. listing, if required

TOPPERS

Control panel styling and appearance can be changed by adding an auxiliary "Topper". See page 4.

BUTTONS

.200" (5.08 mm) button height shown is standard. Other heights available are .125" (3.18 mm), .328" (8.3 mm), and .453" (11.51 mm).

MOUNTING

PANEL—Two .100" diameter holes on .812" centers. 4-40 extruded and tapped mounting holes are also available.

PRINTED CIRCUIT BOARD—Plug directly into board having hole pattern suggested in drawing.

TERMINALS

Standard is solder terminal G-20-28 as shown. For PC applications, we suggest G-20-18, but you may specify the terminal of your choice from those shown on page 15.

SOLDER SHIELD

Vulcanized fiber shield .020" thick may be shipped assembled or separate as requested.

ACTUATOR KNOB

Decorative aluminum sleeved actuating knob is available. Same as shown on pg. 5. Specify GB-125 or GB-126 with appropriate suffix indicating your current requirement. .453" knob height shown is standard. Also available in heights of .162" (4.11 mm), .200" (5.08 mm), .562" (14.27 mm), and .709" (18.01 mm).

TOP-ACTUATED PANEL MOUNT MINIATURE SWITCHES

GF-161 Three Pole/Double Throw (with detent)



TYPE	ELECTRICAL RATING	LISTING*
GF-161	0.5 A at 125 Vac/Vdc	U.L. & C.S.A.
GF-161-3	3.0 A ac, 0.5 A at 125 Vdc	U.L. & C.S.A.
GF-161-8.5	8.5 A ac, 0.5 A at 125 Vdc	U.L. & C.S.A.

*Specify C.S.A. listing, if required.

TOPPERS

Control panel styling and appearance can be changed by adding an auxiliary "Topper". See page 4.

BUTTONS

.200" (5.08 mm) button height shown is standard. Other heights available are .100" (2.54 mm), .328" (8.33 mm) and .453" (11.51 mm).

MOUNTING

PANEL—Two .100" diameter holes on .812" centers. 4-40 extruded and tapped holes are available or plug directly into board having hole pattern shown.

TERMINALS

Standard is solder terminal G-20-28 as shown. For PC applications, we suggest G-20-18, but you may specify the terminal of your choice from those shown on page 15.

SOLDER SHIELD

Vulcanized fiber shield .020" thick may be shipped assembled or separate as requested.

G-127L Single Pole/Three Position (with detent) G-128L Two Pole/Three Position (with detent)

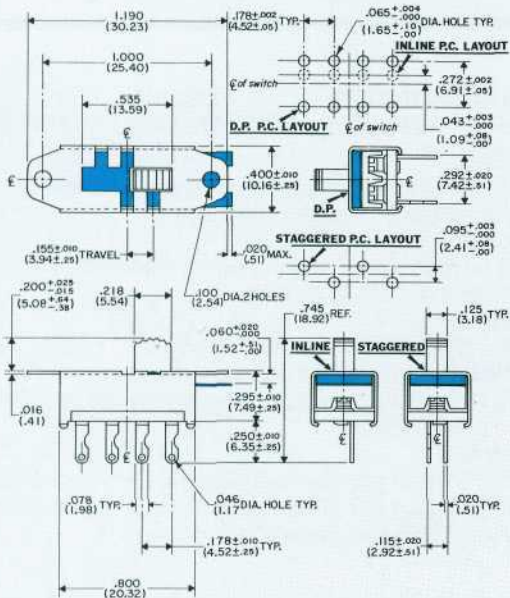

TYPE	ELECTRICAL RATING	LISTING*
*G-127L/S	.05 A at 125 Vac/Vdc	U.L. & C.S.A.
*G-128L/S	.05 A at 125 Vac/Vdc	U.L. & C.S.A.
*G-127L/S-3	3.0 A ac, 0.5 A at 125 Vdc	U.L. & C.S.A.
*G-128L/S-3	3.0 A ac, 0.5 A at 125 Vdc	U.L. & C.S.A.
*G-127L/S-6	6.0 A ac, 0.5 A at 125 Vdc	U.L. & C.S.A.
*G-128L/S-6	6.0 A ac, 0.5 A at 125 Vdc	U.L. & C.S.A.
*G-127L/S-8.5	8.5 A ac, 0.5 A at 125 Vdc	U.L. & C.S.A.
*G-128L/S-8.5	8.5 A ac, 0.5 A at 125 Vdc	U.L. & C.S.A.

*Order either G-127L or G-127S or either G-128L or G-128S depending on your need for long or short detent plate as described.

*Specify C.S.A. listing, if required.

TOPPERS

Control panel styling and appearance can be changed by adding an auxiliary "Topper." See page 4.

BUTTONS

.200" (5.08 mm) button height shown is standard. Other heights available are .125" (3.18 mm), .328" (8.33 mm), and .453" (11.51 mm).

MOUNTING

PANEL—Two .100" diameter holes on 1.000" centers. 4-40 extruded and tapped holes are available.

PRINTED CIRCUIT BOARD—Plug directly into printed circuit board having hole pattern mating with your switch terminals. Standard G-127L/S single pole terminal orientation is IN LINE. For greater switch stability on your PC board before soldering, specify STAGGERED terminals.

TERMINALS

Standard is solder terminal G-20-28 as shown. For PC applications, we suggest G-20-18, but you may specify the terminal of your choice from those shown on page 15.

SOLDER SHIELD

Vulcanized fiber shield .020" thick may be shipped assembled or separate as requested.

Drawing shows button in extreme right position where LONG detent plate covers topside opening to the left of the button and extends beyond (in blue) housing on right. Specify G-127L or G-128L with suffix indicating current requirement. If topside opening need not be covered, specify G-127S or G-128S with appropriate suffix.

TOP-ACTUATED PANEL MOUNT MINIATURE SWITCHES

G-173 Single Pole/Three Position (spring return, both ends to center)

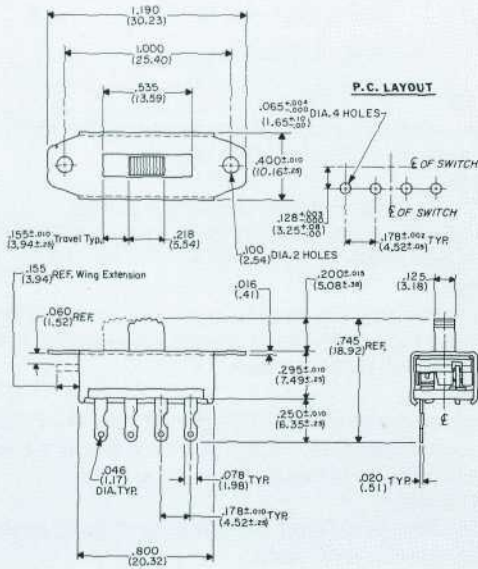

ELECTRICAL RATING

0.5 A at 125 Vac/Vdc

LISTING*

U.L. & C.S.A.

*Specify C.S.A. listing, if required

TOPPERS

Control panel styling and appearance can be changed by adding an auxiliary "Topper". See page 4.

BUTTONS

.200" (5.08 mm) button height shown is standard. Other heights available are .328" (8.33 mm) and .438" (11.13 mm).

MOUNTING

PANEL—Two .100" diameter holes on 1.000" centers.

PRINTED CIRCUIT BOARD—Plug directly into a printed circuit board having the suggested hole pattern shown.

TERMINALS

Standard is solder terminal G-20-28 as shown. For PC applications, we suggest G-20-18, but you may specify the terminal of your choice from those shown on page 15.

SOLDER SHIELD

Vulcanized fiber shield .020" thick may be shipped assembled or separate as requested.

G-175 Double Pole/Three Position (spring return, both ends, to center)

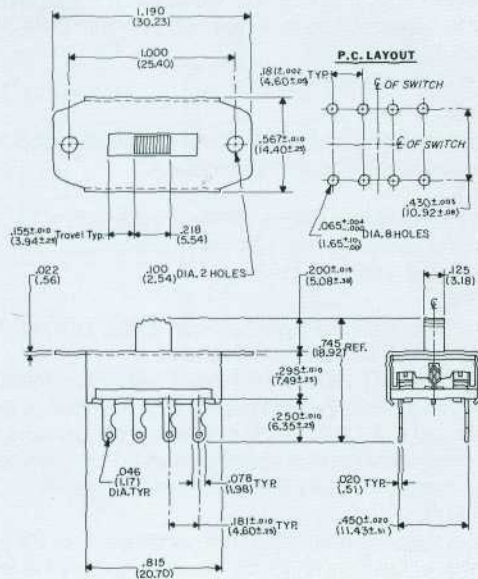

ELECTRICAL RATING

0.5 A at 125 Vac/Vdc

LISTING

U.L.

TOPPERS

Control panel styling and appearance can be changed by adding an auxiliary "Topper". See page 4.

BUTTONS

.200" (5.08 mm) button height shown is standard. Also available is .328" (8.33 mm).

MOUNTING

PANEL—Two .100" diameter holes on 1.000" centers. Also available are 4-40 extruded and tapped holes.

PRINTED CIRCUIT BOARD—Plug directly into board having hole pattern shown.

TERMINALS

Standard is solder terminal G-20-28 as shown. For PC applications, we suggest G-20-18, but you may specify the terminal of your choice from those shown on page 15.

TOP-ACTUATED PANEL MOUNT MINIATURE SWITCHES

G-168 Three Pole/Three Position (with detent)

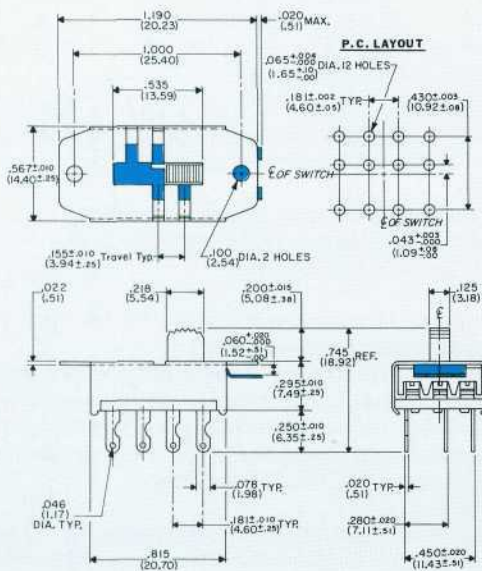

Drawing shows button in extreme right position where LONG detent plate covers topside opening to the left of the button and extends beyond (in blue) housing on right. Specify G-168L with suffix indicating current requirement. If topside opening need not be covered, specify G-168S with appropriate suffix.

TYPE	ELECTRICAL RATING	LISTING
G-168-L	0.5 A at 125 Vac/Vdc	U.L.
G-168-S	0.5 A at 125 Vac/Vdc	U.L.
G-168-L-3	3.0 A ac, 0.5 A at 125 Vdc	U.L.
G-168-S-3	3.0 A ac, 0.5 A at 125 Vdc	U.L.
G-168-L-8.5	8.5 A ac, 0.5 A at 125 Vdc	U.L.
G-168-S-8.5	8.5 A ac, 0.5 A at 125 Vdc	U.L.

TOPPERS

Control panel styling and appearance can be changed by adding an auxiliary "Topper". See page 4.

BUTTONS

.200" (5.08 mm) button height shown is standard. Other heights available are .328" (8.33 mm) and .453" (11.51 mm).

MOUNTING

PANEL—Two .100" diameter holes on 1.000" centers. Also available are 4-40 extruded and tapped holes.

PRINTED CIRCUIT BOARD—Plug directly into printed circuit board having hole pattern shown.

TERMINALS

Standard is solder terminal G-20-28 as shown. For PC applications, we suggest G-20-18, but you may specify the terminal of your choice from those shown on page 15.

G-169 Four Pole/Three Position (with detent)

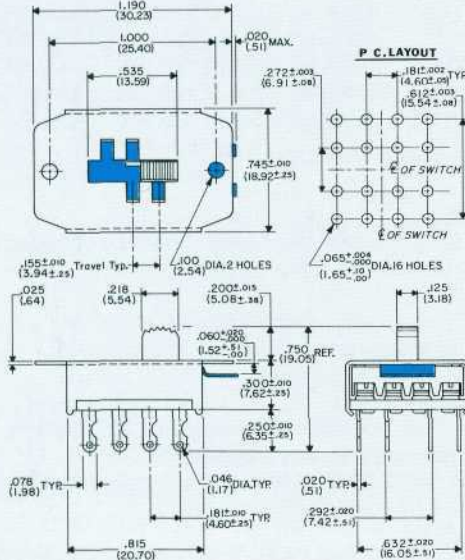

Drawing shows button in extreme right position where LONG detent plate covers topside opening to the left of the button and extends beyond (in blue) housing on right. Specify G-169L with suffix indicating current requirement. If topside opening need not be covered, specify G-169S with appropriate suffix.

TYPE	ELECTRICAL RATING	LISTING*
G-169-L	0.5 A at 125 Vac/Vdc	U.L. & C.S.A.
G-169-S	0.5 A at 125 Vac/Vdc	U.L. & C.S.A.
G-169-L-3	3.0 A ac, 0.5 A at 125 Vdc	U.L. & C.S.A.
G-169-S-3	3.0 A ac, 0.5 A at 125 Vdc	U.L. & C.S.A.

*Specify C.S.A. listing, if required.

TOPPERS

Control panel styling and appearance can be changed by adding an auxiliary "Topper". See page 4.

BUTTONS

.200" (5.08 mm) button height shown is standard. Other heights available are .125" (3.18 mm), .328" (8.33 mm), and .453" (11.51 mm).

MOUNTING

PANEL—Two .100" diameter holes on 1.000" centers. 4-40 extruded and tapped holes are available.

PRINTED CIRCUIT BOARD—Plug directly into printed circuit board having hole pattern shown.

TERMINALS

Standard is solder terminal G-20-28 as shown. For PC applications, we suggest G-20-18, but you may specify the terminal of your choice from those shown on page 15.

SOLDER SHIELD

Vulcanized fiber shield .020" thick may be shipped assembled or separate as requested.

TOP-ACTUATED PANEL MOUNT MINIATURE SWIDGETS

G-140 Single Pole/Four Position (with detent)

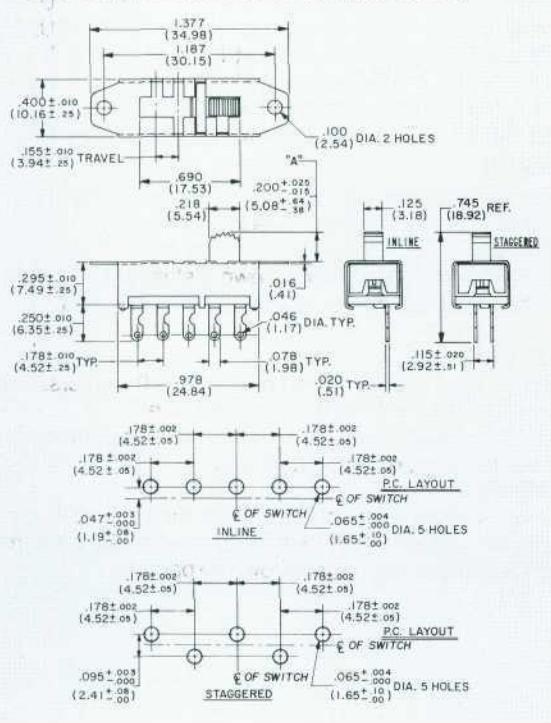

TYPE	ELECTRICAL RATING	LISTING*
G-140-S	0.5 A at 125 Vac/Vdc	U.L. & C.S.A.
G-140-S-3	3.0 A ac, 0.5 A at 125 Vdc	U.L. & C.S.A.
G-140-S-6	6.0 A ac, 0.5 A at 125 Vdc	U.L. & C.S.A.
G-140-S-8.5	8.5 A ac, 0.5 A at 125 Vdc	U.L. & C.S.A.

*Specify C.S.A. listing, if required.

TOPPERS

Control panel styling and appearance can be changed by adding an auxiliary "Topper". See page 4.

BUTTONS

.200" (5.08 mm) button height shown is standard. Other heights available are .125" (3.18 mm), .328" (8.35 mm), and .453" (11.51 mm).

MOUNTING

PANEL—Two .100" diameter holes on 1.187" centers. 4-40 extruded and tapped holes are available.

PRINTED CIRCUIT BOARD—Plug directly into printed circuit board having hole pattern mating with your switch terminals. Standard G-140S single pole terminal orientation is IN LINE. For greater switch stability on your PC board before soldering, specify STAGGERED terminals.

TERMINALS

Standard is solder terminal G-20-28 as shown. For PC applications, we suggest G-20-18, but you may specify the terminal of your choice from those shown on page 15.

G-141 Double Pole/Four Position (with detent)

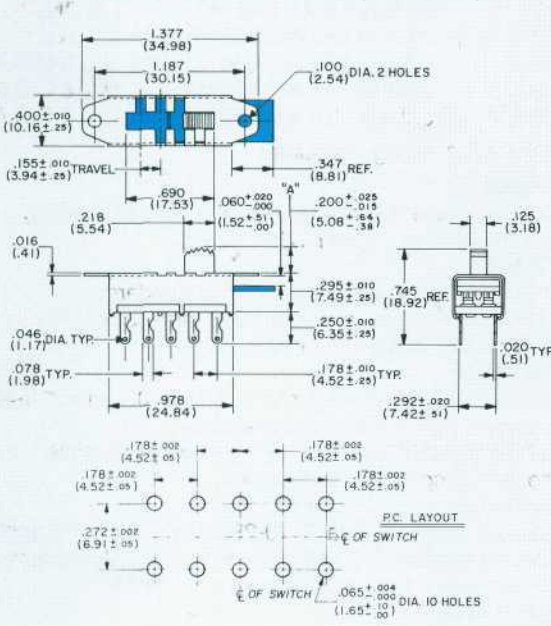

TYPE	ELECTRICAL RATING	LISTING*
G-141-S	0.5 A at 125 Vac/Vdc	U.L. & C.S.A.
G-141-S-3	3.0 A ac, 0.5 A at 125 Vdc	U.L. & C.S.A.
G-141-S-6	6.0 A ac, 0.5 A at 125 Vdc	U.L. & C.S.A.
G-141-S-8.5	8.5 A ac, 0.5 A at 125 Vdc	U.L. & C.S.A.
G-141-L	0.5 A at 125 Vac/Vdc	U.L. & C.S.A.
G-141-L-3	3.0 A ac, 0.5 A at 125 Vdc	U.L. & C.S.A.
G-141-L-6	6.0 A ac, 0.5 A at 125 Vdc	U.L. & C.S.A.
G-141-L-8.5	8.5 A ac, 0.5 A at 125 Vdc	U.L. & C.S.A.

*Specify C.S.A. listing, if required.

TOPPERS

Control panel styling and appearance can be changed by adding an auxiliary "Topper". See page 4.

BUTTONS

.200" (5.08 mm) button height shown is standard. Other heights available are .125" (3.18 mm), .328" (8.33 mm), .453" (11.51 mm).

MOUNTING

PANEL—Two .100" diameter holes on 1.187" centers. 4-40 extruded and tapped holes are available.

PRINTED CIRCUIT BOARD—Plug directly into printed circuit board having hole pattern shown.

TERMINALS

Standard is solder terminal G-20-28 as shown. For PC applications, we suggest G-20-18, but you may specify the terminal of your choice from those shown on page 15.

Drawing shows button in extreme right position where LONG detent plate covers topside opening to the left of the button and extends beyond (in blue) housing on right. Specify G-141L with suffix indicating current requirement. If topside opening need not be covered, specify G-141S with appropriate suffix.

SIDE-ACTUATED PANEL MOUNT MINIATURE SWIDGETS

GI-151 Single Pole/Double Throw (with detent)
GI-152 Double Pole/Double Throw (with detent)



TYPE	ELECTRICAL RATING	LISTING*
GI-151	0.5 A at 125 Vac/Vdc	U.L. & C.S.A.
GI-151-3	3.0 A ac, 0.5 A at 125 Vdc	U.L. & C.S.A.

TYPE	ELECTRICAL RATING	LISTING*
GI-152	0.5 A at 125 Vac/Vdc	U.L. & C.S.A.
GI-152-3	3.0 A ac, 0.5 A at 125 Vdc	U.L. & C.S.A.

*Specify C.S.A. listing, if required.

TOPPERS

Control panel styling and appearance can be changed by adding an auxiliary "Topper". See page 12.

BUTTONS

.200" (5.08 mm) button length shown is standard. Other lengths available are .328" (8.33 mm) and .453" (11.51 mm).

MOUNTING

PANEL—Two .100" diameter holes on .812" centers. 4-40 extruded and tapped holes are also available.

PRINTED CIRCUIT BOARD—Plug directly into printed circuit board having hole pattern mating with your switch terminals. Standard single pole terminal orientation is IN-LINE. For greater switch stability on your P.C. Board before soldering, specify STAGGERED terminals. For PC board mount, we recommend use of mounting ears to supplement support provided by terminals.

TERMINALS

Standard is G-20-28 terminal. Also available, if specified, are terminals shown on page 15.

SOLDER SHIELD

Vulcanized fiber shield .020" thick may be shipped assembled or separate as requested.

GI-153 Single Pole/Three Position (with detent)
GI-154 Double Pole/Three Position (with detent)



TYPE	ELECTRICAL RATING	LISTING*
GI-153	0.5 A at 125 Vac/Vdc	U.L. & C.S.A.
GI-153-3	3.0 A at 125 Vac	U.L. & C.S.A.

TYPE	ELECTRICAL RATING	LISTING*
GI-154	0.5 A at 125 Vac/Vdc	U.L. & C.S.A.
GI-154-3	3.0 A ac, 0.5 A at 125 Vdc	U.L. & C.S.A.

*Specify C.S.A. listing, if required.

TOPPERS

Control panel styling and appearance can be changed by adding an auxiliary "Topper". See page 12.

BUTTONS

.200" (5.08 mm) button length shown is standard. Other lengths available are .328" (8.33 mm) and .453" (11.51 mm).

MOUNTING

PANEL—Two .100" diameter holes on 1.000" centers. 4-40 extruded and tapped mounting holes are available.

PRINTED CIRCUIT BOARD—Plug directly into printed circuit board having hole pattern mating with your switch terminals. Standard single pole terminal orientation is IN LINE. For greater switch stability on your PC board before soldering, specify STAGGERED terminals. For PC board mount, we recommend use of mounting ears to supplement support provided by terminals.

TERMINALS

Standard is G-20-28 terminal. Also available, if specified, are terminals shown on page 15.

SIDE-ACTUATED PANEL MOUNT MINIATURE SWIDGETS

GF-165 Three Pole/Double Throw (with detent)

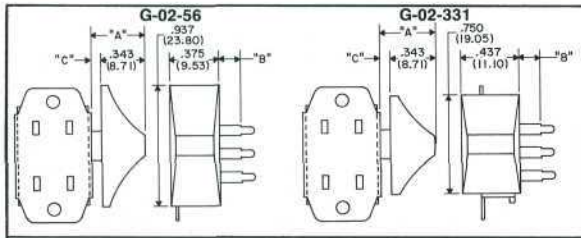
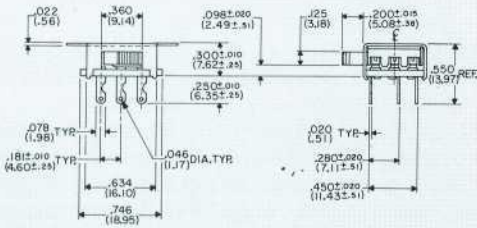

ELECTRICAL RATING

0.5 A at 125 Vac/Vdc

LISTING*

U.L. & C.S.A.

*Specify C.S.A. listing, if required.

BUTTONS

.200" (5.08 mm) button length shown is standard. Other lengths available are .328" (8.33 mm), and .453" (11.51 mm).

MOUNTING

PANEL—Two .100" diameter holes on .812" centers.
PRINTED CIRCUIT BOARD—Plug directly into PC board having hole pattern shown. For PC board mount, we recommend use of mounting ears to supplement support provided by terminals.

TERMINALS

Standard is solder terminal G-20-28 as shown. For PC applications, we suggest G-20-18, but you may specify the terminal of your choice from those shown on page 15.

SOLDER SHIELD

Vulcanized fiber shield .020" thick may be shipped assembled or separate as requested.

TOPPERS

Control panel styling and appearance can be changed by adding an auxiliary "Topper", as shown below.

W/TERMINAL	G-02-56	G-02-331
	(DIM "B")	
G-20-18	.032 (.81)	Not recommended
G-20-19	.251 (6.38)	.211 (5.36)
G-20-25	.115 (2.92)	.075 (1.91)

GI-158 Single Pole/Four Position (with detent)

GI-159 Double Pole/Four Position (with detent)

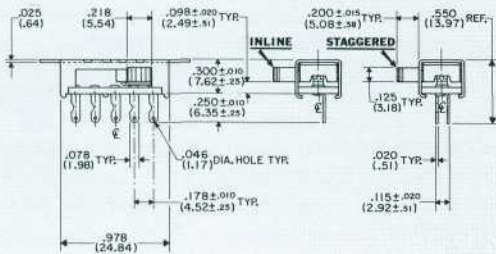
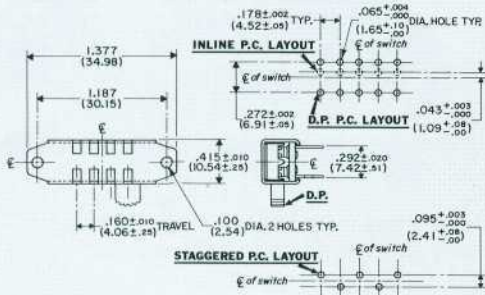

TYPE

GI-158

GI-158-3

GI-159

GI-159-3

ELECTRICAL RATING

0.5 A at 125 Vac/Vdc

3.0 A ac, 0.5 A at 125 Vdc

0.5 A at 125 Vac/Vdc

3.0 A ac, 0.5 A at 125 Vdc

LISTING*

U.L. & C.S.A.

U.L. & C.S.A.

U.L. & C.S.A.

U.L. & C.S.A.

*Specify C.S.A. listing, if required.

TOPPERS

Control panel styling and appearance can be changed by adding an auxiliary "Topper". See above.

BUTTONS

.200" (5.08 mm) button length shown is standard. Other lengths available are .328" (8.33 mm), and .453" (11.51 mm).

MOUNTING

PANEL—Two .100" diameter holes on 1.187" centers.
PRINTED CIRCUIT BOARD—Plug directly into printed circuit board having hole pattern mating with your switch terminals. Standard single pole terminal orientation is IN LINE. For greater switch stability on your PC board before soldering, specify STAGGERED terminals. For PC board mount, we recommend use of mounting ears to supplement support provided by terminals.

TERMINALS

Standard is solder terminal G-20-28 as shown. For PC applications, we suggest G-20-18, but you may specify the terminal of your choice from those shown on page 15.

SOLDER SHIELD

Vulcanized fiber shield .020" thick may be shipped assembled or separate as requested.

SIDE-ACTUATED PANEL MOUNT MINIATURE SWIDGETS

GI-163 Double Pole/Five Position (with detent)

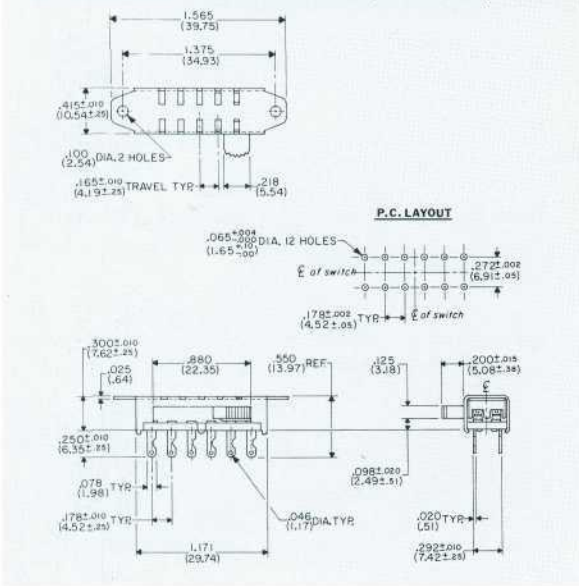

TYPE	ELECTRICAL RATING	LISTING*
GI-163	0.5 A at 125 Vac/Vdc	U.L. & C.S.A.
GI-163-3	3.0 A ac, 0.5 A at 125 Vdc	U.L. & C.S.A.

*Specify C.S.A. listing, if required.

TOPPERS

Control panel styling and appearance can be changed by adding an auxiliary "Topper". See page 12.

BUTTONS

.200" (5.08 mm) button length shown is standard. Other lengths available are .328" (8.33 mm) and .453" (11.51 mm).

MOUNTING

PANEL—Two .100" diameter holes on 1.375" centers.
PRINTED CIRCUIT BOARD—Plug directly into board having suggested hole pattern shown. For PC board mount, we recommend use of mounting ears to supplement support provided by terminals.

TERMINALS

Standard is solder terminal G-20-28 as shown. For PC applications, we suggest G-20-18, but you may specify the terminal of your choice from those shown on page 15.

SOLDER SHIELD

Vulcanized fiber shield .020" thick may be shipped assembled or separate as requested.

TOP-ACTUATED 4-POINT PC BOARD MOUNT MINIATURE SWIDGET

GPF-124 Single Pole Double Throw (with detent)
GPF-126 Double Pole Double Throw (with detent)



GP-132 Single Pole Double Throw (spring return)



TYPE	ELECTRICAL RATING	LISTING*
GPF-124	0.5 A at 125 Vac/Vdc	U.L. & C.S.A.
GPF-124-3	3.0 A ac 0.5 A at 125 Vdc	U.L. & C.S.A.
GPF-126	0.5 A at 125 Vac/Vdc	U.L. & C.S.A.
GPF-126-3	3.0 A ac 0.5 A at 125 Vdc	U.L. & C.S.A.

*Specify C.S.A. listing, if required.

TYPE	ELECTRICAL RATING	LISTING*
GP-132	0.5 A at 125 Vac/Vdc	U.L. & C.S.A.
GP-132-3	3.0 A ac 0.5 A at 125 Vdc	U.L. & C.S.A.

*Specify C.S.A. listing, if required.

TOPPERS— Control panel styling and appearance can be changed by adding an auxiliary "Topper". See page 4.

BUTTONS— .200" (5.08 mm) button height shown is standard. Other heights available are .125" (3.18 mm), .328" (8.33 mm), and 4.53" (11.51 mm).

MOUNTING— Plug directly into PC board having suggested hole pattern shown.

SOLDER SHIELD— Vulcanized fiber shield .020" thick may be shipped assembled or separate as requested.

SIDE-ACTUATED 4-POINT PC BOARD MOUNT MINIATURE SWIDGET

GPI-151 Single Pole Double Throw (with detent)
GPI-152 Double Pole Double Throw (with detent)



GPI-153 Single Pole 3 Pos (with detent)
GPI-154 Double Pole 3 Pos (with detent)



TYPE	RATING	LISTING*
GPI-151	0.5 A at 125 Vac/Vdc	U.L. & C.S.A.
GPI-151-3	3.0 A at 125 Vac/Vdc	U.L. & C.S.A.
GPI-152	0.5 A at 125 Vac/Vdc	U.L. & C.S.A.
GPI-152-3	3.0 A at 125 Vac/Vdc	U.L. & C.S.A.

*Specify C.S.A. listing, if required.

TYPE	RATING	LISTING*
GPI-153	0.5 A at 125 Vac/Vdc	U.L. & C.S.A.
GPI-153-3	3.0 A at 125 Vac/Vdc	U.L. & C.S.A.
GPI-154	0.5 A at 125 Vac/Vdc	U.L. & C.S.A.
GPI-154-3	3.0 A at 125 Vac/Vdc	U.L. & C.S.A.

*Specify C.S.A. listing, if required.

TOPPERS— Control panel styling and appearance can be changed by adding an auxiliary "Topper". See page 12.
BUTTONS— .200" (5.08 mm) button length shown is standard. Other lengths available are .328" (8.33 mm) and .453" (11.51 mm).
MOUNTING— Plug directly into PC board having suggested hole pattern shown.
SOLDER SHIELD— Vulcanized fiber shield .020" thick may be shipped assembled or separate as requested.

END-ACTUATED PC BOARD MOUNT MINIATURE SWIDGET

G-133 PCE Single Pole/Double Throw (spring return)



TYPE	ELECTRICAL RATING	LISTING*
G-133 PCE	0.5 A 125 Vac/Vdc	U.L. & C.S.A.
G-133-3 PCE	3.0 ac, 0.5 A 125 Vdc	U.L. & C.S.A.
G-133-8.5 PCE	8.5 A ac, 0.5 A 125 Vdc	U.L. & C.S.A.

*Specify C.S.A. listing, if required.

MOUNTING
 Mounts directly into PC board having suggested hole pattern shown in PC Layout.

TERMINALS
 Standard G-20-18 shown. Also choose from G-20-39 and G-20-59 shown on page 15.

SOLDER SHIELD
 Vulcanized fiber shield .020" thick may be shipped assembled or separate as requested.

TERMINAL OPTIONS

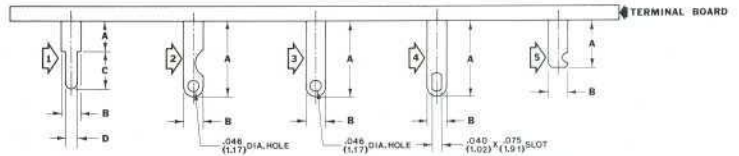

Specify terminal part number of your choice.

Dimension	TERMINAL PART NO						
	G-20-18	G-20-19	G-20-39	G-20-59	G-20-60	G-20-69	G-20-75
A	.064 ± .010 (1.62 ± .25)	.283 ± .010 (7.19 ± .25)	.063 ± .010 (1.60 ± .25)	.063 ± .010 (1.60 ± .25)	.034 ± .010 (.86 ± .25)	.096 ± .010 (2.44 ± .25)	.147 ± .010 (3.73 ± .25)
B	.078 ± .003 (1.98 ± .08)	.078 ± .003 (1.98 ± .08)	.078 ± .003 (1.98 ± .08)	.078 ± .003 (1.98 ± .08)	.078 ± .003 (1.98 ± .08)	.078 ± .003 (1.98 ± .08)	.078 ± .003 (1.98 ± .08)
C	.155 ± .010 (3.94 ± .25)	.155 ± .010 (3.94 ± .25)	.090 ± .010 (2.29 ± .25)	.110 ± .010 (2.79 ± .25)	.125 ± .010 (3.18 ± .25)	.146 ± .010 (3.71 ± .25)	.100 ± .010 (2.54 ± .25)
D	.050 (1.27)	.050 (1.27)	.050 (1.27)	.050 (1.27)	.050 (1.27)	.050 (1.27)	.050 (1.27)
Style No.	1	1	1	1	1	1	1

Dimension	TERMINAL PART NO							
	G-20-83	G-20-89	G-20-98	G-20-114	G-20-28	G-20-28-4	G-20-41	G-20-46
A	.470 ± .010 (11.94 ± .25)	.050 ± .010 (9.27 ± .25)	.038 ± .010 (.97 ± .25)	.650 ± .010 (16.51 ± .25)	.250 ± .010 (6.35 ± .25)	.250 ± .010 (6.35 ± .25)	.250 ± .010 (6.35 ± .25)	.133 ± .010 (3.38 ± .25)
B	.078 ± .003 (1.98 ± .08)	.078 ± .003 (1.98 ± .08)	.078 ± .003 (1.98 ± .08)	.078 ± .003 (1.98 ± .08)	.078 ± .003 (1.98 ± .08)	.078 ± .003 (1.98 ± .08)	.078 ± .003 (1.98 ± .08)	.078 ± .003 (1.98 ± .08)
C	.155 ± .010 (3.94 ± .25)	.155 ± .010 (3.94 ± .25)	.181 ± .010 (4.60 ± .25)	.155 ± .010 (3.94 ± .25)	—	—	—	—
D	.050 (1.27)	.050 (1.27)	.050 (1.27)	.050 (1.27)	—	—	—	—
Style No.	1	1	1	1	2	3	4	5

NOTES

Send for more information about CW and its products:

Switches

- Section II** Standard slide switches—up to 13.0 amps, 125 Vac; with actuator travel of .158 for spdt switches
- Section IV** Microminiature slide switches—up to 1.0 amps, 125 Vac; with actuator travel of .105 for spdt switches
- Section V** Fully enclosed microminiature slide switches—up to 0.5 amps, 125 Vac; with actuator travel of .090 for spdt switches

Rocker & Power Slide Switches – Miniature and standard sized; Snap-in mounting; up to 16A @ 125 - 250 VAC; SPST thru DPDT center-off & momentary

Custom designed switches to meet special requirements also available; consult factory.

IDC Connectors

Section VIII

CW Industries also manufactures a comprehensive product line of insulation displacement connectors designed for mass termination. CW's patented Torq-Tite™ contact provides complete connection reliability between conductor and contact. This is available in Dip Card Edge, PCB, Subminiature "D"s, and socket IDC connectors. Mating headers also are part of this CW product line. Send for Catalog C2110.



CW INDUSTRIES

130 James Way, Southampton, PA 18966-3838 • Tel. 215-355-7080 • Fax 215-355-1088 • www.cwind.com

QUALITY PRODUCTS THRU CREATIVE ENGINEERING

Компания «Океан Электроники» предлагает заключение долгосрочных отношений при поставках импортных электронных компонентов на взаимовыгодных условиях!

Наши преимущества:

- Поставка оригинальных импортных электронных компонентов напрямую с производств Америки, Европы и Азии, а так же с крупнейших складов мира;
- Широкая линейка поставок активных и пассивных импортных электронных компонентов (более 30 млн. наименований);
- Поставка сложных, дефицитных, либо снятых с производства позиций;
- Оперативные сроки поставки под заказ (от 5 рабочих дней);
- Экспресс доставка в любую точку России;
- Помощь Конструкторского Отдела и консультации квалифицированных инженеров;
- Техническая поддержка проекта, помощь в подборе аналогов, поставка прототипов;
- Поставка электронных компонентов под контролем ВП;
- Система менеджмента качества сертифицирована по Международному стандарту ISO 9001;
- При необходимости вся продукция военного и аэрокосмического назначения проходит испытания и сертификацию в лаборатории (по согласованию с заказчиком);
- Поставка специализированных компонентов военного и аэрокосмического уровня качества (Xilinx, Altera, Analog Devices, Intersil, Interpoint, Microsemi, Actel, Aeroflex, Peregrine, VPT, Syfer, Eurofarad, Texas Instruments, MS Kennedy, Miteq, Cobham, E2V, MA-COM, Hittite, Mini-Circuits, General Dynamics и др.);

Компания «Океан Электроники» является официальным дистрибьютором и эксклюзивным представителем в России одного из крупнейших производителей разъемов военного и аэрокосмического назначения «JONHON», а так же официальным дистрибьютором и эксклюзивным представителем в России производителя высокотехнологичных и надежных решений для передачи СВЧ сигналов «FORSTAR».



JONHON

«JONHON» (основан в 1970 г.)

Разъемы специального, военного и аэрокосмического назначения:

(Применяются в военной, авиационной, аэрокосмической, морской, железнодорожной, горно- и нефтедобывающей отраслях промышленности)

«FORSTAR» (основан в 1998 г.)

ВЧ соединители, коаксиальные кабели, кабельные сборки и микроволновые компоненты:

(Применяются в телекоммуникациях гражданского и специального назначения, в средствах связи, РЛС, а так же военной, авиационной и аэрокосмической отраслях промышленности).



Телефон: 8 (812) 309-75-97 (многоканальный)

Факс: 8 (812) 320-03-32

Электронная почта: ocean@oceanchips.ru

Web: <http://oceanchips.ru/>

Адрес: 198099, г. Санкт-Петербург, ул. Калинина, д. 2, корп. 4, лит. А