

MAX16929

Automotive TFT-LCD Power Supply with Boost Converter and Gate Voltage Regulators

General Description

The MAX16929 is a highly integrated power supply for automotive TFT-LCD applications. The device integrates one buck converter, one boost converter, one 1.8V/3.3V regulator controller, and two gate voltage regulators. The device comes in several versions to satisfy common automotive power-supply requirements (see the [Ordering Information/Selector Guide](#) table).

Designed to operate from a single 4V to 28V supply or 5.5V to 28V supply, the device is ideal for automotive TFT-LCD applications.

Both the buck and boost converters use spread-spectrum modulation to reduce peak interference and to optimize EMI performance.

The sequencing input (SEQ) allows flexible sequencing of the positive-gate and negative-gate voltage regulators. The power-good indicator (PGOOD) indicates a failure on any of the converters or regulator outputs. Integrated thermal shutdown circuitry protects the device from overheating.

The MAX16929 is available in a 28-pin TSSOP package with exposed pad, and operates over the -40°C to +105°C temperature range.

Applications

Automotive Dashboards
Automotive Central Information Displays
Automotive Navigation Systems

Features

- ◆ **Operating Voltage Range of 4V to 28V (Buck) or 3V to 5.5V (Boost)**
- ◆ **Independent 28V Input Buck Converter Powers TFT Bias Supply Circuitry and External Circuitry**
- ◆ **High-Power (Up to 6W) Boost Output Providing Up to 18V**
- ◆ **1.8V or 3.3V Regulator Provides 500mA with External npn Transistor**
- ◆ **One Positive-Gate Voltage Regulator Capable of Delivering 20mA at 28V**
- ◆ **One Negative-Gate Voltage Regulator**
- ◆ **High-Frequency Operation**
 - ◇ 2.1MHz (Buck Converter)
 - ◇ 2.2MHz (Boost Converter)
- ◆ **Flexible Stand-Alone Sequencing**
- ◆ **True Shutdown™ Boost Converter**
- ◆ **6µA Low-Current Shutdown Mode (Buck)**
- ◆ **Internal Soft-Start**
- ◆ **Overtemperature Shutdown**
- ◆ **-40°C to +105°C Operation**

[Ordering Information/Selector Guide](#) appears at end of data sheet.

[Typical Application Circuit](#) appears at end of data sheet.

True Shutdown is a trademark of Maxim Integrated Products, Inc.

For related parts and recommended products to use with this part, refer to: www.maxim-ic.com/MAX16929.related

Automotive TFT-LCD Power Supply with Boost Converter and Gate Voltage Regulators

ABSOLUTE MAXIMUM RATINGS

INB, ENB to GND	-0.3V to +42V	ENP, DR, FB, GATE, COMPI, FBGH,
BST to GND.....	-0.3V to +47V	FBGL, REF, SEQ to GND
BST to LXB	-0.3V to +6V	GND to PGNDP
LXB to GND.....	-6V to +42V	Continuous Power Dissipation (T _A = +70°C)
AVL, PGOOD to GND	-0.3V to +6V	TSSOP (derate 27mW/°C above +70°C).....
FBB to GND.....	-0.5V to +12V	Operating Temperature Range.....
CP, GH to GND	-0.3V to +31V	Junction Temperature Range.....
CP, GH to GND (V _{INA} = 3.3V)	-0.3V to +29V	Storage Temperature Range.....
LXP to GND	-0.3V to +20V	Lead Temperature (soldering, 10s)
DRVN to GND.....	-25V to +0.3V	Soldering Temperature (reflow)
INA, COMPV, FBP to GND.....	-0.3V to +6V	

Stresses beyond those listed under "Absolute Maximum Ratings" may cause permanent damage to the device. These are stress ratings only, and functional operation of the device at these or any other conditions beyond those indicated in the operational sections of the specifications is not implied. Exposure to absolute maximum rating conditions for extended periods may affect device reliability.

PACKAGE THERMAL CHARACTERISTICS (Note 1)

TSSOP

Junction-to-Ambient Thermal Resistance (θ _{JA})	37°C/W
Junction-to-Case Thermal Resistance (θ _{JC})	2°C/W

Note 1: Package thermal resistances were obtained using the method described in JEDEC specification JESD51-7, using a four-layer board. For detailed information on package thermal considerations, refer to www.maxim-ic.com/thermal-tutorial.

ELECTRICAL CHARACTERISTICS

(V_{INB} = 12V, V_{INA} = 5V, V_{GND} = V_{PGNDP} = 0V, T_A = T_J = -40°C to +105°C, typical values are at T_A = +25°C, unless otherwise noted.) (Note 2)

PARAMETER	SYMBOL	CONDITIONS	MIN	TYP	MAX	UNITS	
BUCK CONVERTER							
Supply Voltage Range	V _{INB}	V _{OUTB} = 5V (Note 3)	5.5		28	V	
		V _{OUTB} = 3.3V (Note 3)	4		28		
		t < 500ms			42		
Supply Current	I _{INB}	V _{ENB} = 0V		6	9	μA	
		V _{ENB} = V _{INB} , no load, T _A = +25°C		70			
Undervoltage Lockout	V _{INB,UVLO}	AVL rising		3.1	3.5	V	
Undervoltage Lockout Hysteresis				0.5		V	
PWM Switching Frequency	f _{SWB}		1.9	2.1	2.3	MHz	
Spread-Spectrum Range	SSR			+6		%	
Output-Voltage Accuracy	V _{OUTB}	6V ≤ V _{INB} ≤ 18V, I _{LOAD} < full load	5V, continuous mode	-3%	5	+3%	V
			5V, skip mode	-3%	5	+6%	
			3.3V, continuous mode	-3%	3.3	+3%	
			3.3V, skip mode	-3%	3.3	+6%	
High-Side DMOS R _{DS_ON}	R _{DS_ON(LXB)}	I _{LXB} = 1A		180	400	mΩ	
Skip-Current Threshold	I _{SKIP}			16		%I _{MAX}	
Current-Limit Threshold	I _{MAX}	I _{OUTB} = 1.2A option	1.6	2	2.4	A	
		I _{OUTB} = 2.0A option	2.7	3.4	4.08		

Automotive TFT-LCD Power Supply with Boost Converter and Gate Voltage Regulators

ELECTRICAL CHARACTERISTICS (continued)

($V_{INB} = 12V$, $V_{INA} = 5V$, $V_{GND} = V_{PGNDP} = 0V$, $T_A = T_J = -40^\circ C$ to $+105^\circ C$, typical values are at $T_A = +25^\circ C$, unless otherwise noted.)
(Note 2)

PARAMETER	SYMBOL	CONDITIONS	MIN	TYP	MAX	UNITS
Soft-Start Ramp Time				3.9		ms
Maximum Duty Cycle		Continuous mode		80		%
Minimum Duty Cycle		Continuous mode		20		%
Maximum Duty Cycle in Dropout		Dropout		95		%
Thermal Shutdown Temperature				+175		$^\circ C$
Thermal Shutdown Hysteresis				15		$^\circ C$
POWER GOOD (PGOOD)						
PGOOD Threshold		Rising		94		%
		Falling	90	92	95	
PGOOD Debounce Time				13		μs
Output High-Leakage Current					0.2	μA
Output Low Level					0.4	V
LOGIC LEVELS						
ENB Threshold		ENB rising	1.4	1.8	2.2	V
ENB Hysteresis				0.2		V
ENB Input Current			3	5	9	μA
BOOST, POSITIVE (GH), NEGATIVE (GL), 1.8V/3.3V CONVERTERS						
INA Input Supply Range	V_{INA}		3		5.5	V
INA Supply Current	I_{INA}	$V_{FBP} = V_{FBGH} = 1.3V$, $V_{FBGL} = 0V$, LXP not switching		1.5	2.0	mA
INA Undervoltage Lockout Threshold	$V_{INA,UVLO}$	V_{INA} rising, hysteresis = 200mV, $T_A = +25^\circ C$	2.5	2.7	2.9	V
INA Shutdown Current	I_{SHDN}	$V_{ENP} = 0V$, $T_A = +25^\circ C$		0.5		μA
Thermal Shutdown Temperature	T_{SHDN}	Temperature rising		+165		$^\circ C$
Thermal Shutdown Hysteresis	T_H			15		$^\circ C$
Duration to Trigger Fault Condition		V_{FBP} , V_{FBGH} , or V_{FBGL} below its threshold		238		ms
Autoretry Time				1.9		s
REFERENCE (REF)						
REF Output Voltage	V_{REF}	No output current	1.236	1.25	1.264	V
REF Load Regulation		$0 < I_{REF} < 80\mu A$, REF sourcing	-2		+2	%
REF Undervoltage Lockout Threshold		Rising edge, hysteresis = 200mV			1.165	V
OSCILLATOR						
Internal Oscillator Frequency	f_{OSC}	$T_A = +25^\circ C$	3.96	4.40	4.84	MHz
Spread-Spectrum Modulation Frequency	f_{SS}			$f_{OSC}/2$		MHz

Automotive TFT-LCD Power Supply with Boost Converter and Gate Voltage Regulators

ELECTRICAL CHARACTERISTICS (continued)

($V_{INB} = 12V$, $V_{INA} = 5V$, $V_{GND} = V_{PGNDP} = 0V$, $T_A = T_J = -40^{\circ}C$ to $+105^{\circ}C$, typical values are at $T_A = +25^{\circ}C$, unless otherwise noted.)
(Note 2)

PARAMETER	SYMBOL	CONDITIONS	MIN	TYP	MAX	UNITS
Spread-Spectrum Factor	SSR	As a percentage of switching frequency, f_{SW}		±4		%
BOOST CONVERTER						
Switching Frequency	f_{SW}		1.98	2.20	2.42	MHz
Maximum Duty Cycle			82		93.5	%
LXP Current Limit	I_{LIM}	Duty cycle = 70%, $C_{COMP1} = 220pF$	Low boost current-limit option		1.87	A
			High boost current-limit option			
LXP On-Resistance	$R_{DS_ON(LXP)}$	$I_{LXP} = 200mA$		110	250	mΩ
LXP Leakage Current	I_{LK_LXP}	$V_{LXP} = 20V$, $T_A = +25^{\circ}C$		8.5	20	μA
Soft-Start Time		(Note 4)		30		ms
Output Voltage Range	V_{SH}		V_{INA}		18	V
FBP Regulation Voltage	V_{FBP}	$V_{INA} = +3V$ to $+5.5V$, $0 < I_{LOAD} < \text{full load}$	$T_A = +25^{\circ}C$		1.015	V
			$T_A = -40^{\circ}C$ to $+105^{\circ}C$		1.02	
PGOOD Threshold	V_{PG_FBP}	Measured at FBP	0.74	0.85	0.96	V
FBP Load Regulation		$0 < I_{LOAD} < \text{full load}$		-1		%
FBP Line Regulation		$V_{INA} = +3V$ to $+5.5V$		0.1		%/V
FBP Input Bias Current		$V_{FBP} = +1V$, $T_A = +25^{\circ}C$			±1	μA
FBP to COMPV Transconductance		$\Delta I = \pm 2.5\mu A$ at COMPV, $T_A = +25^{\circ}C$		400		μS
POSITIVE-GATE VOLTAGE REGULATOR (GH)						
Output Voltage Range	V_{GH}	With external charge pump, $T_A = +25^{\circ}C$ (maximum $V_{CP} = 29.5V$)	5		29	V
CP Overvoltage Threshold		$T_A = +25^{\circ}C$ (Note 6)	29.5	30.5		V
FBGH Regulation Voltage	V_{FBGH}	$I_{GH} = 1mA$	0.98	1.0	1.034	V
PGOOD Threshold	V_{PG_FBGH}	Measured at FBGH	0.83	0.85	0.87	V
FBGH Load Regulation		$I_{GH} = 0$ to $20mA$		2		%
FBGH Line Regulation		$V_{CP} = 12V$ to $20V$ at $V_{GH} = 10V$, $I_{GH} = 10mA$		2		%
FBGH Input Bias Current		$V_{FBGH} = 1V$, $T_A = +25^{\circ}C$			±1	μA
GH Output Current	I_{GH}	$V_{CP} - V_{GH} = 2V$	20			mA
GH Current Limit	I_{LIM_GH}		35	56		mA
GH Soft-Start Time				7.45		ms
NEGATIVE-GATE VOLTAGE REGULATOR (GL)						
Output Voltage Range	V_{DRVN}		-24		-2	V
FBGL Regulation Voltage	V_{FBGL}	$I_{DRVN} = 100\mu A$	0.212	0.242	0.271	V

Automotive TFT-LCD Power Supply with Boost Converter and Gate Voltage Regulators

ELECTRICAL CHARACTERISTICS (continued)

($V_{INB} = 12V$, $V_{INA} = 5V$, $V_{GND} = V_{PGNDP} = 0V$, $T_A = T_J = -40^{\circ}C$ to $+105^{\circ}C$, typical values are at $T_A = +25^{\circ}C$, unless otherwise noted.)
(Note 2)

PARAMETER	SYMBOL	CONDITIONS	MIN	TYP	MAX	UNITS	
PGOOD Threshold	V_{PG_FBGL}	Measured at FBGL	0.38	0.4	0.42	V	
FBGL Input Bias Current		$V_{FBGL} = +0.25V$			± 1	μA	
DRVN Source Current		$V_{FBGL} = +0.5V$, $V_{DRVN} = -10V$	2			mA	
DRVN Source Current Limit			2.5	4		mA	
GL Soft-Start Time				7.45		ms	
1.8V/3.3V REGULATOR CONTROLLER							
Output Voltage	V_{FB}	$V_{DR} = V_{FB}$	3.3V regulator option	3.18	3.3	3.38	V
			1.8V regulator option	1.746	1.8	1.854	
FB PGOOD Threshold	V_{PG_FB}	Measured at FB (Notes 5, 7)	3.3V regulator option, FB rising	2.4	2.57	2.7	V
			1.8V regulator option	1.364	1.38	1.396	
FB Input Bias Current		$V_{FB} = 1.8V$		2.5		μA	
		$V_{FB} = 3.3V$		4.5			
DR Drive Current		$V_{FB} = 1.8V$	4.5	6		mA	
INPUT SERIES SWITCH CONTROL							
p-Channel FET GATE Sink Current		$V_{GATE} = 0.5V$	33	55	75	μA	
GATE Voltage Threshold		Measured at GATE; below this voltage, the external p-channel FET is considered on		1.25		V	
DIGITAL LOGIC							
ENP, SEQ Input Pulldown Resistor Value	R_{PD}			500		k Ω	
ENP, SEQ Input-Voltage Low	V_{IL}			$0.3 \times V_{INA}$		V	
ENP, SEQ Input-Voltage High	V_{IH}		$0.7 \times V_{INA}$			V	
PGOOD Leakage Current	I_{LK_IN}	$T_A = +25^{\circ}C$			± 1	μA	
PGOOD Output-Voltage Low	V_{OL}	2mA sink current, $T_A = +25^{\circ}C$			0.4	V	

Note 2: Specifications over temperature are guaranteed by design and not production tested.

Note 3: Operation in light-load conditions or at extreme duty cycles result in skipped cycles, resulting in lower operating frequency and possibly limited output accuracy and load response.

Note 4: 50% of the soft-start voltage time is due to the soft-start ramp, and the other 50% is due to the settling of the output voltage.

Note 5: Guaranteed by design; not production tested.

Note 6: After the voltage at CP exceeds this overvoltage threshold, the entire circuit switches off and autoretry is started.

Note 7: FB power good is indicated by PGOOD. The condition $V_{FB} < V_{PG_FB}$ does not shutdown/restart the device.

MAX16929

Automotive TFT-LCD Power Supply with Boost Converter and Gate Voltage Regulators

Typical Operating Characteristics

($V_{INA} = 5V$, $V_{INB} = 12V$, measurements taken on "A" version, unless otherwise noted; $V_{SH} = 12V$, $V_{GH} = 18V$, $V_{GL} = -6V$, $V_{REG} = 3.3V$, $V_{OUTB} = 5V$, $T_A = +25^\circ C$, unless otherwise noted.)



Automotive TFT-LCD Power Supply with Boost Converter and Gate Voltage Regulators

Typical Operating Characteristics (continued)

($V_{INA} = 5V$, $V_{INB} = 12V$, measurements taken on "A" version, unless otherwise noted; $V_{SH} = 12V$, $V_{GH} = 18V$, $V_{GL} = -6V$, $V_{REG} = 3.3V$, $V_{OUTB} = 5V$, $T_A = +25^\circ C$, unless otherwise noted.)

LINE-TRANSIENT RESPONSE (BUCK)



SHORT-CIRCUIT BEHAVIOR (BUCK)



LOAD DUMP RESPONSE



INA SHUTDOWN SUPPLY CURRENT



EFFICIENCY vs. LOAD CURRENT (BOOST)



LOAD REGULATION (BOOST)



LINE REGULATION (BOOST)



Automotive TFT-LCD Power Supply with Boost Converter and Gate Voltage Regulators

Typical Operating Characteristics (continued)

($V_{INA} = 5V$, $V_{INB} = 12V$, measurements taken on "A" version, unless otherwise noted; $V_{SH} = 12V$, $V_{GH} = 18V$, $V_{GL} = -6V$, $V_{REG} = 3.3V$, $V_{OUTB} = 5V$, $T_A = +25^\circ C$, unless otherwise noted.)

STARTUP WAVEFORMS (BOOST)



LOAD-TRANSIENT RESPONSE (BOOST)



SUPPLY SEQUENCING WAVEFORMS (VSEQ = 0V)



SUPPLY SEQUENCING WAVEFORMS (VSEQ = VINA)



LOAD REGULATION (GH REGULATOR)



LINE REGULATION (GH REGULATOR)



Automotive TFT-LCD Power Supply with Boost Converter and Gate Voltage Regulators

Typical Operating Characteristics (continued)

($V_{INA} = 5V$, $V_{INB} = 12V$, measurements taken on "A" version, unless otherwise noted; $V_{SH} = 12V$, $V_{GH} = 18V$, $V_{GL} = -6V$, $V_{REG} = 3.3V$, $V_{OUTB} = 5V$, $T_A = +25^\circ C$, unless otherwise noted.)



MAX16929

Automotive TFT-LCD Power Supply with Boost Converter and Gate Voltage Regulators

Pin Configuration



Pin Description

PIN	NAME	FUNCTION
1	ENP	Boost Circuitry and 1.8V/3.3V Regulator Controller Enable Input. ENP has an internal 500k Ω pulldown resistor. Drive high for normal operation and drive low to place the device (except buck converter) in shutdown.
2	DR	1.8V or 3.3V Regulator Output. DR has a 4.5mA (min) drive capability. For greater output current capability, use an external npn bipolar transistor whose base is connected to DR.
3	FB	1.8V or 3.3V Regulator Feedback Input. FB is regulated to 1.8V or 3.3V. Connect FB to DR when powering loads demanding less than 4.5mA. For greater output current capability, use an external npn bipolar transistor whose emitter is connected to FB.
4	GATE	External p-Channel FET Gate Drive. GATE is an open-drain driver connected to the gate of the external input series p-channel FET. Connect a pullup resistor between GATE and INA. During a fault condition, the gate driver turns off and the pullup resistor turns off the FET.
5	PGNDP	Boost Converter Power Ground
6	LXP	Boost Converter Switching Node. Connect LXP to the inductor and catch diode of the boost converter.
7	INA	Boost Circuitry and 1.8V/3.3V Regulator Controller Power Input. Connect INA to a 3V to 5.5V supply.
8	COMPV	Boost Error Amplifier Compensation Connection. Connect a compensation network between COMPV to GND.
9	FBP	Boost Converter Feedback Input. FBP is regulated to 1V. Connect FBP to the center of a resistive divider connected between the boost output and GND.

Automotive TFT-LCD Power Supply with Boost Converter and Gate Voltage Regulators**Pin Description (continued)**

PIN	NAME	FUNCTION
10	FBB	Buck Converter Feedback Input. FBB is regulated to either 3.3V or 5V. Connect FBB to the output-voltage node, OUTB, as shown in the Typical Application Circuit .
11	AVL	Buck Converter Internal 5V Regulator. Connect a 1 μ F capacitor between AVL and the analog ground plane. Do not use AVL to power external circuitry.
12	BST	Buck Converter Bootstrap Capacitor Connection. Connect a 0.1 μ F capacitor between BST and LXB.
13, 14	LXB	Buck Converter Inductor Connection. Connect the inductor, boost capacitor, and catch diode at this node.
15, 16	INB	Buck Converter Power Input. Connect to a 4V to 28V supply. Connect a 1 μ F or larger ceramic capacitor in parallel with a 47 μ F bulk capacitor from INB to the power ground plane. Connect both INB power inputs together.
17	ENB	Buck Converter Enable Input. ENB is a high-voltage compatible input. Connect to INB for normal operation and connect to ground to disable the buck converter.
18, 23	GND	Analog Ground
19	PGOOD	Open-Drain Power-Good Output. Connect PGOOD to INA through an external pullup resistor.
20	CP	Positive-Gate Voltage Regulator Power Input. Connect CP to the positive output of the external charge pump. Ensure that V_{CP} does not exceed the CP overvoltage threshold as given in the Electrical Characteristics table.
21	GH	Positive-Gate Voltage Regulator Output
22	DRVN	Negative-Gate Voltage Regulator Driver Output. DRVN is the open drain of an internal p-channel FET. Connect DRVN to the base of an external npn pass transistor.
24	COMPI	Boost Slope Compensation Connection. Connect a capacitor between COMPI and GND to set the slope compensation.
25	FBGH	Positive-Gate Voltage Regulator Feedback Input. FBGH is regulated to 1V. Connect FBGH to the center of a resistive divider connected between GH and GND.
26	FBGL	Negative-Gate Voltage Regulator Feedback Input. FBGL is regulated to 0.25V. Connect FBGL to the center of a resistive divider connected between REF and the output of the negative-gate voltage regulator.
27	REF	1.25V Reference Output. Bypass REF to GND with a 0.1 μ F ceramic capacitor.
28	SEQ	Sequencing Input. SEQ has an internal 500k Ω pulldown resistor. SEQ determines the sequence in which V_{GH} and V_{GL} power-up. See Table 1 for supply sequencing options.
—	EP	Exposed Pad. Connect to a large contiguous copper ground plane for optimal heat dissipation. Do not use EP as the only electrical ground connection.

Automotive TFT-LCD Power Supply with Boost Converter and Gate Voltage Regulators

Detailed Description

The MAX16929 is a highly integrated power supply for automotive TFT-LCD applications. The device integrates one buck converter, one boost converter, one 1.8V/3.3V regulator controller, one positive-gate voltage regulator, and one negative-gate voltage regulator.

The device achieves enhanced EMI performance through spread-spectrum modulation. Digital input control allows the device to be placed in a low-current shutdown mode and provides flexible sequencing of the gate voltage regulators.

Internal thermal shutdown circuitry protects the device from overheating. The buck converter is designed to shut down when its die temperature reaches +175°C (typ), while the boost circuitry does so at +165°C (typ). Each resumes normal operation once its die temperature has fallen 15°C below its respective thermal shutdown temperature.

The device is factory-trimmed to provide a variety of power options to meet the most common automotive TFT-LCD display power requirements, as outlined in the [Ordering Information/Selector Guide](#) table.

Buck Converter

The device features a current-mode buck converter with an integrated high-side FET, which requires no external compensation network. The buck converter regulates the output voltage to within ±3% in continuous mode over line and load conditions. The high 2.1MHz (typ) switching frequency allows for small external components, reduced output ripple, and guarantees no AM interference.

A power-good (PGOOD) indicator is available to monitor output-voltage quality. The enable input allows the device to be placed in shutdown, reducing supply current to 70µA.

The buck converter comes with a preset output voltage of either 3.3V or 5V, and can deliver either 1.2A or 2A to the output.

Enable (ENB)

Connect ENB to INB for always-on operation. ENB is also compatible with 3.3V logic systems and can be controlled through a microcontroller or by automotive KEY or CAN inhibit signals.

Internal 5V Regulator (AVL)

AVL is an internal 5V regulator that supplies power to the buck controller and charges the boost capacitor. After

enabling the buck converter, V_{AVL} begins to rise. Once V_{AVL} exceeds the undervoltage lockout voltage of 3.5V (max), LXB starts switching. Bypass AVL to GND with a 1µF ceramic capacitor.

Spread-Spectrum Modulation

The buck converter features spread-spectrum operation that varies the internal operating frequency of the buck converter by +6% relative to the switching frequency of 2.1MHz (typ).

Soft-Start

The buck converter features an internal soft-start timer. The output voltage takes 3.9ms to ramp up to its set voltage. If a short circuit or undervoltage is encountered after the soft-start timer has expired, the device enters hiccup mode, during which soft-start is reattempted every 16ms. This process repeats until the short circuit has been removed.

Overcurrent Protection

The device enters hiccup mode in one of three ways. If eight consecutive current limits are detected and the output is below 77% of its nominal value, the buck converter enters hiccup mode. The converter enters hiccup mode immediately if the output is short circuited to ground (output below 1V). Additionally, the device enters hiccup mode if 256 consecutive overcurrent events are detected when the output is greater than 77% of its nominal value. In hiccup mode, the buck controller idles for 16ms before reattempting soft-start.

Power Good (PGOOD)

When an overcurrent condition causes the buck output to fall below 92% of its set voltage, the open-drain power-good indicator output (PGOOD) asserts low. PGOOD deasserts once the output voltage has risen above 95% of its set voltage.

PGOOD serves as a general fault indicator for all the converters and regulators. Besides indicating an undervoltage on the buck output, it also indicates any of the faults listed in the [Fault Conditions and PGOOD](#) section.

Boost Converter

The boost converter employs a current-mode, fixed-frequency PWM architecture to maximize loop bandwidth and provide fast transient response to pulsed loads typical of TFT-LCD panel source drivers. The 2.2MHz switching frequency allows the use of low-profile inductors and ceramic capacitors to minimize the thickness of LCD panel designs. The integrated low on-resistance MOSFET and

Automotive TFT-LCD Power Supply with Boost Converter and Gate Voltage Regulators

the device's built-in digital soft-start functions reduce the number of external components required while controlling inrush currents. The output voltage can be set from V_{INA} to 18V with an external resistive voltage-divider. The regulator controls the output voltage by modulating the duty cycle (D) of the internal power MOSFET in each switching cycle. The duty cycle of the MOSFET is approximated by:

$$D = 1 - \frac{\eta V_{IN}}{V_O}$$

where V_{IN} is the voltage at INA, $V_O = V_{SH}$ (the boost output voltage), and η is the efficiency of the boost converter, as shown in the [Typical Operating Characteristics](#).

[Figure 1](#) shows the functional diagram of the boost regulator. An error amplifier compares the signal at FBP

to 1V and changes the COMPV output. The voltage at COMPV sets the peak inductor current. As the load varies, the error amplifier sources or sinks current to the COMPV output accordingly to produce the peak inductor current necessary to service the load. To maintain stability at high duty cycles, a slope-compensation signal (set by the capacitor at COMPI) is summed with the current-feedback signal. On the rising edge of the internal clock, the controller turns on the n-channel MOSFET and applies the input voltage across the inductor. The current through the inductor ramps up linearly, storing energy in its magnetic field. Once the sum of the current feedback signal and the slope compensation exceeds the COMPV voltage, the controller turns off the MOSFET. The inductor current then flows through the diode to the output. The MOSFET remains off for the rest of the clock cycle.



Figure 1. Boost Converter Functional Diagram

Automotive TFT-LCD Power Supply with Boost Converter and Gate Voltage Regulators

The external p-channel FET controlled by GATE protects the output during fault conditions and provides True Shutdown of the converter. Connect a pullup resistor between GATE and INA (see the [Boost Converter](#) section to select the value for the pullup resistor). Under normal operation, GATE turns on the p-channel FET, connecting the supply to the boost input. During a fault condition or in shutdown, GATE is off and the pullup resistor turns off the p-channel FET, disconnecting the supply from the boost input.

Spread-Spectrum Modulation

The high-frequency 2.2MHz operation of the boost converter keeps switching noise outside of the AM band. The device achieves enhanced EMI performance by modulating the switching frequency by $\pm 4\%$. The modulating signal is pseudorandom and changes each switching period (i.e., $f_{SS} = 2.2\text{MHz}$).

Startup

Immediately after power-up, coming out of shutdown, or going into autoretry, the boost converter performs a short-circuit detection test on the output by connecting the input (INA) to the switching node (LXP) through an internal 50Ω resistor.

If the resulting voltage on LXP exceeds 1.2V, the device turns on the external pMOS switch by pulling GATE low. The boost output ramps to its final value in 15ms.

An overloaded or shorted output is detected if the resulting voltage on LXP is below 1.2V. The external pMOS switch remains off and the converter does not switch. After the fault blanking period of 238ms, the device pulls PGOOD low and starts the autoretry timer.

The short-circuit detection feature places a lower limit on the output load of approximately 46Ω when the input voltage is 3V.

Fault Conditions and PGOOD

PGOOD signals whether all the regulators and the boost converter are operating normally. PGOOD is an open-drain output that pulls low if any of the following faults occur:

- 1) The boost output voltage falls below 85% of its set value.
- 2) The positive-gate voltage regulator output (V_{GH}) falls below 85% of its set value.
- 3) The negative-gate voltage regulator output (V_{GL}) falls below 85% of its set value.

- 4) The LXP voltage is greater than 21V (typ).
- 5) The positive charge-pump voltage (V_{CP}) is greater than 30.5V (typ).
- 6) The 1.8V/3.3V regulator output voltage falls below 85% of its nominal value.
- 7) The buck output voltage falls below 92% of its nominal value.

If any of the first three fault conditions persists for longer than the 238ms fault blanking period, the device pulls PGOOD low, turns off all outputs, and starts the autoretry timer.

If either condition 4 or 5 occurs, the device pulls PGOOD low and turns off all outputs immediately. The device initiates startup only after the fault has cleared.

If condition 6 occurs, the device pulls PGOOD low, but does not turn off any of the outputs.

During startup, PGOOD is masked and goes high as soon as the 1.8V/3.3V regulator controller turns on. This regulator turns on as soon as V_{INA} exceeds the INA undervoltage lockout threshold.

Autoretry

When the autoretry counter finishes incrementing after 1.9s, the device attempts to turn on the boost converter and gate voltage regulators in the order shown in [Table 1](#). The device continues to autoretry as long as the fault condition persists. A fault on the 1.8V/3.3V regulator output causes PGOOD to go low, but does not result in the device shutting down and going into autoretry.

Current Limit

The effective current limit of the boost converter is reduced by the internally injected slope compensation by an amount dependent on the duty cycle of the converter. The effective current limit is given by:

$$I_{LIM(EFF)} = 192 \times 10^{-12} \times I_{LIM_DC_0} \times \frac{D}{C_{COMPI}}$$

where $I_{LIM(EFF)}$ is the effective current limit, $I_{LIM_DC_0} = 1.1\text{A}$ or 2.2A depending on the boost converter current-limit option, D is the duty cycle of the boost converter, and C_{COMPI} is the value of the capacitor at the COMPI input. Estimate the duty cycle of the converter using the formulas shown in the [Design Procedure](#) section.

Automotive TFT-LCD Power Supply with Boost Converter and Gate Voltage Regulators

1.8V/3.3V Regulator Controller

The 1.8V/3.3V regulator controller delivers 4.5mA (min) to an external load. Connect FB to DR for a regulated 1.8V/3.3V output.

For higher output capability, use an external npn transistor as shown in the [Typical Application Circuit](#). The drive capability of the regulator is then increased by the current gain of the transistor (h_{FE}). When using an external transistor, use DR as the base drive and connect FB to the transistor's emitter. Bypass the base to ground with a 0.1 μ F ceramic capacitor.

If the boost output current is greater than 300mA, connect a 30k Ω resistor between DR and GND.

Positive-Gate Voltage Regulator (GH)

The positive-gate voltage regulator includes a p-channel FET output stage to generate a regulated output between +5V and $V_{CP} - 2V$. The regulator maintains accuracy over wide line and load conditions. It is capable of at least 20mA of output current and includes current-limit protection. V_{GH} is typically used to provide the TFT-LCD gate drivers' gate-on voltage.

The regulator derives its positive supply voltage from a noninverting charge pump, a single-stage example of which is shown in the [Typical Application Circuit](#). A higher voltage using a multistage charge pump is possible, as described in the [Charge Pumps](#) section.

Negative-Gate Voltage Regulator (GL)

The negative-gate voltage regulator is an analog gain block with an open-drain p-channel output. It drives an external npn pass transistor with a 6.8k Ω base-to-emitter resistor (see the [Pass Transistor Selection](#) section). Its guaranteed base drive source current is at least 2mA. V_{GL} is typically used to provide the TFT-LCD gate drivers' gate-off voltage.

The output of the negative-gate voltage regulator (i.e., the collector of the external npn pass transistor) has load-

dependent bypassing requirements. Connect a ceramic capacitor between the collector and ground with the value shown in [Table 3](#).

The regulator derives its negative supply voltage from an inverting charge pump, a single-stage example of which is shown in the [Typical Application Circuit](#). A more negative voltage using a multistage charge pump is possible as described in the [Charge Pumps](#) section.

The external npn transistor is not short-circuit protected. To maintain proper pulldown capability of external npn transistor and optimal regulation, a minimum load of at least 500 μ A is recommended on the output of the GL regulator.

Enable (ENP)

Use the enable input (ENP) to enable and disable the boost section of the device. Connect ENP to INA for normal operation and to GND to place the device in shutdown. In shutdown, the INA supply current is reduced to 0.5 μ A.

Soft-Start and Supply Sequencing (SEQ)

When enabled, the boost output ramps up from V_{INA} to its set voltage. Once the boost output reaches 85% of the set voltage and the soft-start timer expires, the gate voltage regulators turn on in the order shown in [Table 1](#). The 1.8V/3.3V regulator controller is enabled at the beginning of the boost converter's soft-start.

Both gate voltage regulators have a 7.45ms soft-start time. The second one turns on as soon as the output of the first reaches 85% of its set voltage.

Thermal Shutdown

Internal thermal shutdown circuitry shuts down the device immediately when the die temperature exceeds +165°C. A 15°C thermal shutdown hysteresis prevents the device from resuming normal operation until the die temperature falls below +150°C.

Table 1. Supply Sequencing

CONTROL INPUTS		SUPPLY SEQUENCING		
ENP	SEQ	FIRST	SECOND	THIRD
0	X	Device is in shutdown		
1	0	V_{SH}	V_{GH}	V_{GL}
1	1	V_{SH}	V_{GL}	V_{GH}

Automotive TFT-LCD Power Supply with Boost Converter and Gate Voltage Regulators

Design Procedure

Buck Converter Inductor Selection

Three key inductor parameters must be specified for operation with the device: inductance value (L), inductor saturation current (I_{SAT}), and DC resistance (R_{DC}). To determine the inductance value, select the ratio of inductor peak-to-peak ripple current to average output current (LIR) first. For LIR values that are too high, the RMS currents are high, and therefore I²R losses are high. Use high-valued inductors to achieve low LIR values. Typically, inductance is proportional to resistance for a given package type, which again makes I²R losses high for very low LIR values. A good compromise between size and loss is to select a 30%-to-60% peak-to-peak ripple current to average-current ratio. If extremely thin high-resistance inductors are used, as is common for LCD-panel applications, the best LIR can increase between 0.5 and 1.0. The size of the inductor is determined as follows:

$$L = \frac{(V_{INB} - V_O) \times D}{LIR \times I_O \times f_{SWB}} \text{ and}$$

$$D = \frac{V_O}{\eta \times V_{INB}}$$

where V_{INB} is the input voltage, V_O is the output voltage, I_O is the output current, η is the efficiency of the buck converter, D is the duty cycle, and f_{SWB} is 2.1MHz (the switching frequency of the buck converter). The efficiency of the buck converter can be estimated from the [Typical Operating Characteristics](#) and accounts for losses in the internal switch, catch diode, inductor R_{DC}, and capacitor ESR.

To ensure the buck converter does not shut down during load dump input-voltage transients to 42V, an inductor value larger than calculated above should be used. [Table 2](#) lists the minimum inductance that should be used for proper operation during load dump. The saturation current rating (I_{SAT}) must be high enough to ensure that saturation can occur only above the maximum current-limit value. Find a low-loss inductor having the lowest possible DC resistance that fits in the allotted dimensions.

Table 2. Minimum Buck Inductor Value Required for Normal Operation During Load Dump

BUCK V _{OUTB} (V)	BUCK I _{OUTB} (A)	L _{MIN} (μH)
3.3	1.2	3.3
3.3	2	6.8
5	1.2	3.3
5	2	4.7

Capacitor Selection

The input and output filter capacitors should be of a low-ESR type (tantalum, ceramic, or low-ESR electrolytic) and should have I_{RMS} ratings greater than:

$$I_{INB(RMS)} = I_O \sqrt{D \times (1-D + \frac{LIR^2}{12})} \text{ for the input capacitor}$$

$$I_{OUTB(RMS)} = \frac{LIR \times I_O}{\sqrt{12}} \text{ for the output capacitor}$$

where D is the duty cycle given above.

The output voltage contains a ripple component whose peak-to-peak value depends on the value of the ESR and capacitance of the output capacitor, and is approximately given by:

$$\Delta V_{RIPPLE} = \Delta V_{ESR} + \Delta V_{CAP}$$

$$\Delta V_{ESR} = LIR \times I_O \times R_{ESR}$$

$$\Delta V_{CAP} = \frac{LIR \times I_O}{8 \times C \times f_{SWB}}$$

Diode Selection

The catch diode should be a Schottky type to minimize its voltage drop and maximize efficiency. The diode must be capable of withstanding a reverse voltage of at least the maximum input voltage in the application. The diode should have an average forward current rating greater than:

$$I_D = I_O \times (1-D)$$

where D is the duty cycle given above. In addition, ensure that the peak current rating of the diode is greater than:

$$I_{OUTB} \times \left(1 + \frac{LIR}{2}\right)$$

Automotive TFT-LCD Power Supply with Boost Converter and Gate Voltage Regulators

Boost Converter Inductor Selection

Three key inductor parameters must be specified for operation with the device: inductance value (L), inductor saturation current (I_{SAT}), and DC resistance (R_{DC}). To determine the inductance value, select the ratio of inductor peak-to-peak ripple current to average input current (LIR) first. For LIR values that are too high, the RMS currents are high, and therefore I²R losses are high. Use high-valued inductors to achieve low LIR values. Typically, inductance is proportional to resistance for a given package type, which again makes I²R losses high for very low LIR values. A good compromise between size and loss is to select a 30%-to-60% peak-to-peak ripple current to average-current ratio. If extremely thin high-resistance inductors are used, as is common for LCD-panel applications, the best LIR can increase between 0.5 and 1.0. The size of the inductor is determined as follows:

$$L = \frac{V_{INA} \times D}{LIR \times I_{INP} \times f_{SW}} \quad \text{and} \quad I_{INP} = \frac{V_O \times I_O}{\eta V_{INA}}$$

$$D = 1 - \frac{\eta V_{INA}}{V_O}$$

where V_{INA} is the input voltage, V_O is the output voltage, I_O is the output current, I_{INP} is the average boost input current, η is the efficiency of the boost converter, D is the duty cycle, and f_{SW} is 2.2MHz (the switching frequency of the boost converter). The efficiency of the boost converter can be estimated from the [Typical Operating Characteristics](#) and accounts for losses in the internal switch, catch diode, inductor R_{DC}, and capacitor ESR.

Capacitor Selection

The input and output filter capacitors should be of a low-ESR type (tantalum, ceramic, or low-ESR electrolytic) and should have I_{RMS} ratings greater than:

$$I_{RMS} = \frac{LIR \times I_{INP}}{\sqrt{12}} \quad \text{for the input capacitor}$$

$$I_{RMS} = I_O \sqrt{\frac{D + \frac{LIR^2}{12}}{1-D}} \quad \text{for the output capacitor}$$

where I_{INP} and D are the input current and duty cycle given above.

The output voltage contains a ripple component whose peak-to-peak value depends on the value of the ESR and capacitance of the output capacitor and is approximately given by:

$$\Delta V_{RIPPLE} = \Delta V_{ESR} + \Delta V_{CAP}$$

$$\Delta V_{ESR} = I_{INP} \times \left(1 + \frac{LIR}{2}\right) \times R_{ESR}$$

$$\Delta V_{CAP} = \frac{I_O \times D}{C_{OUT} \times f_{SW}}$$

where I_{INP} and D are the input current and duty cycle given above.

Rectifier Diode

The catch diode should be a Schottky type to minimize its voltage drop and maximize efficiency. The diode must be capable of withstanding a reverse voltage of at least V_{SH}. The diode should have an average forward current rating greater than:

$$I_D = I_{INP} \times (1-D)$$

where I_{INP} and D are the input current and duty cycle given above. In addition ensure that the peak current rating of the diode is greater than:

$$I_{INP} \times \left(1 + \frac{LIR}{2}\right)$$

Output-Voltage Selection

The output voltage of the boost converter can be adjusted by using a resistive voltage-divider formed by R_{TOP} and R_{BOTTOM}. Connect R_{TOP} between the output and FBP and connect R_{BOTTOM} between FBP and GND. Select R_{BOTTOM} in the 10kΩ to 50kΩ range. Calculate R_{TOP} with the following equation:

$$R_{TOP} = R_{BOTTOM} \times \left(\frac{V_O}{V_{FBP}} - 1\right)$$

where V_{FBP}, the boost converter's feedback set point, is 1V. Place both resistors as close as possible to the device and connect R_{BOTTOM} to the analog ground plane.

Loop Compensation

Choose R_{COMPV} to set the high-frequency integrator gain for fast transient response. Choose C_{COMPV} to set the integrator zero to maintain loop stability. For low-ESR output capacitors, use [Table 3](#) to select the initial values for R_{COMPV} and C_{COMPV}. Use a 22pF capacitor in parallel with R_{COMPV} + C_{COMPV}.

Automotive TFT-LCD Power Supply with Boost Converter and Gate Voltage Regulators

Table 3. Compensation Component Values

V_{SH} (V)	8	18
I_{SH} (mA)	200	200
V_{INA} (V)	3.3	5
P_{IN} (W)	1.75	3.75
L (μH)	5	5
R_{COMPV} (kΩ)	33	39
C_{COMPV} (pF)	220	180
C_{COMPI} (pF)	820	330



Figure 2. Multistage Charge Pump for Positive Output Voltage



Figure 3. Multistage Charge Pump for Negative Output Voltage

To further optimize transient response, vary R_{COMPV} in 20% steps and C_{COMPV} in 50% steps while observing transient-response waveforms. The ideal transient response is achieved when the output settles quickly with little or no overshoot. Connect the compensation network to the analog ground plane.

Use the following formula to calculate the value for C_{COMPI}:

$$C_{COMPI} \leq 950 \times 10^{-6} \times L / (V_{SH} + V_{SCHOTTKY} - V_{INA})$$

p-Channel FET Selection

The p-channel FET used to gate the boost converter's input should have low on-resistance. Connect a resistor (R_{SG}) between the source and gate of the FET. Under normal operation, R_{SG} carries a gate drive current of

55μA and the resulting gate source voltage (V_{GS}) turns on the FET. When the gate drive is removed under a fault condition or in shutdown, R_{SG} bleeds off charge to turn off the FET. Size R_{SG} to produce the V_{GS} needed to turn on the FET.

1.8V/3.3V Regulator Controller

nnp Bipolar Transistor Selection

There are two important considerations in selecting the pass npn bipolar transistor: current gain (h_{FE}) and power dissipation. Select a transistor with an h_{FE} high enough to ensure adequate drive capability. This condition is satisfied when I_{DR} × (h_{FE} + 1) is greater than the maximum load current. The regulator can source I_{DR} = 4.5mA (min). The transistor should be capable of dissipating:

$$P_{NPN_REG} = (V_{INA} - V_{REG_OUT}) \times I_{LOAD(MAX)}$$

where V_{REG_OUT} = 1.8V or 3.3V. Bypass DR to ground with a 0.1μF ceramic capacitor. For applications in which the boost output current exceeds 300mA, connect a 30kΩ resistor from DR to ground.

Supply Considerations

INA needs to be at least 4.5V for the 3.3V regulator to operate properly.

Charge Pumps

Selecting the Number of Charge-Pump Stages

For most applications, a single charge-pump stage is sufficient, as shown in the [Typical Application Circuit](#). Connect the flying capacitors to LXP. The output voltages generated on the storage capacitors are given by:

$$V_{CP} = 2 \times V_{SH} + V_{SCHOTTKY} - 2 \times V_D$$

$$V_{CN} = -(V_{SH} + V_{SCHOTTKY} - 2 \times V_D)$$

where V_{CP} is the positive supply for the positive-gate voltage regulator, and V_{CN} is the negative supply for the negative-gate voltage regulator. Where larger output voltages are needed, use multistage charge pumps (however, the maximum charge-pump voltage is limited by the absolute maximum ratings of CP and DRVN). [Figure 2](#) and [Figure 3](#) show the configuration of a multistage charge pump for both positive and negative output voltages.

For multistage charge pumps the output voltages are:

$$V_{CP} = V_{SH} + n \times (V_{SH} + V_{SCHOTTKY} - 2 \times V_D)$$

$$V_{CN} = -n \times (V_{SH} + V_{SCHOTTKY} - 2 \times V_D)$$

For highest efficiency, choose the lowest number of charge-pump stages that meets the output requirement.

Automotive TFT-LCD Power Supply with Boost Converter and Gate Voltage Regulators

The number of positive charge-pump stages needed is given by:

$$n_{CP} = \frac{V_{GH} + V_{DROPOUT} - V_{SH}}{V_{SH} + V_{SCHOTTKY} - 2 \times V_D}$$

and the number of negative charge-pump stages is given by:

$$n_{CN} = \frac{|V_{GL}| + V_{DROPOUT}}{V_{SH} + V_{SCHOTTKY} - 2 \times V_D}$$

where n_{CP} is the number of positive charge-pump stages, n_{CN} is the number of negative charge-pump stages, V_{GH} is the positive-gate voltage regulator output voltage, V_{GL} is the negative-gate voltage regulator output voltage, V_{SH} is the boost converter's output voltage, V_D is the forward-voltage drop of the charge-pump diode, $V_{SCHOTTKY}$ is the forward drop of the Schottky diode of the boost converter, and $V_{DROPOUT}$ is the dropout margin for the regulator. Use $V_{DROPOUT} = 0.3V$ for the negative voltage regulator and $V_{DROPOUT} = 2V$ at 20mA for the positive-gate voltage regulator.

Flying Capacitors

Increasing the flying capacitor (C_X) value lowers the effective source impedance and increases the output current capability. Increasing the capacitance indefinitely has a negligible effect on output current capability because the internal switch resistance and the diode impedance place a lower limit on the source impedance. A 0.1µF ceramic capacitor works well in most low-current applications. The voltage rating of the flying capacitors for the positive charge pump should exceed V_{CP} , and that for the negative charge pump should exceed the magnitude of V_{CN} .

Charge-Pump Output Capacitor

Increasing the output capacitance or decreasing the ESR reduces the output-ripple voltage and the peak-to-peak transient voltage. With ceramic capacitors, the output-voltage ripple is dominated by the capacitance value. Use the following equation to approximate the required output capacitance for the noninverting charge pump connected to CP:

$$C_{OUT_CP} \geq \frac{D \times I_{LOAD_CP}}{f_{SW} \times V_{RIPPLE_CP}}$$

where C_{OUT_CP} is the output capacitor of the charge pump, D is the duty cycle of the boost converter, I_{LOAD_CP} is the load current of the charge pump, f_{SW} is the

switching frequency of the boost converter, and V_{RIPPLE_CP} is the peak-to-peak value of the output ripple.

For the inverting charge pump connected to CN, use the following equation to approximate the required output capacitance:

$$C_{OUT_CN} \geq \frac{(1-D) \times I_{LOAD_CN}}{f_{SW} \times V_{RIPPLE_CN}}$$

where C_{OUT_CN} is the output capacitor of the charge pump, D is the duty cycle of the boost converter, I_{LOAD_CN} is the load current of the charge pump, f_{SW} is the switching frequency of the boost converter, and V_{RIPPLE_CN} is the peak-to-peak value of the output ripple.

Charge-Pump Rectifier Diodes

Use high-speed silicon switching diodes with a current rating equal to or greater than two times the average charge-pump input current. If it helps avoid an extra stage, some or all of the diodes can be replaced with Schottky diodes with an equivalent current rating.

Positive-Gate Voltage Regulator

Output-Voltage Selection

The output voltage of the positive-gate voltage regulator can be adjusted by using a resistive voltage-divider formed by R_{TOP} and R_{BOTTOM} . Connect R_{TOP} between the output and FBGH, and connect R_{BOTTOM} between FBGH and GND. Select R_{BOTTOM} in the 10kΩ to 50kΩ range. Calculate R_{TOP} with the following equation:

$$R_{TOP} = R_{BOTTOM} \times \left(\frac{V_{GH}}{V_{FBGH}} - 1 \right)$$

where V_{GH} is the desired output voltage and $V_{FBGH} = 1V$ (the regulated feedback voltage for the regulator). Place both resistors as close as possible to the device.

Avoid excessive power dissipation within the internal pMOS device of the regulator by paying attention to the voltage drop across the drain and source. The amount of power dissipation is given by:

$$P_{GL} = (V_{CP} - V_{GH}) \times I_{LOAD(MAX)}$$

where V_{CP} is the noninverting charge-pump output voltage applied to the drain, V_{GH} is the regulated output voltage, and $I_{LOAD(MAX)}$ is the maximum load current.

Stability Requirements

The positive-gate voltage regulator (GH) requires a minimum output capacitance for stability. For an output

Automotive TFT-LCD Power Supply with Boost Converter and Gate Voltage Regulators

voltage of 5V to ($V_{CP} - 2V$) and an output current of 10mA to 15mA, use a minimum capacitance of 0.47 μ F.

Negative-Gate Voltage Regulator

Output-Voltage Selection

The output voltage of the negative-gate voltage regulator can be adjusted by using a resistive voltage-divider formed by R_{TOP} and R_{BOTTOM} . Connect R_{TOP} between REF and FBGL, and connect R_{BOTTOM} between FBGL and the collector of the external npn transistor. Select R_{TOP} greater than 20k Ω to avoid loading down the reference output. Calculate R_{BOTTOM} with the following equation:

$$R_{BOTTOM} = R_{TOP} \times \frac{V_{FBGL} - V_{GL}}{V_{REF} - V_{FBGL}}$$

where V_{GL} is the desired output voltage, $V_{REF} = 1.25V$, and $V_{FBGL} = 0.25V$ (the regulated feedback voltage of the regulator).

Pass Transistor Selection

The pass transistor must meet specifications for current gain (h_{FE}), input capacitance, collector-emitter saturation voltage, and power dissipation. The transistor's current gain limits the guaranteed maximum output current to:

$$I_{LOAD(MAX)} = (I_{DRVN} - \frac{V_{BE}}{R_{BE}}) \times h_{FE(MIN)}$$

where I_{DRVN} is the minimum guaranteed base-drive current, V_{BE} is the transistor's base-to-emitter forward voltage drop, and R_{BE} is the pulldown resistor connected between the transistor's base and emitter. Furthermore, the transistor's current gain increases the regulator's DC loop gain (see the [Stability Requirements](#) section), so excessive gain destabilizes the output.

The transistor's saturation voltage at the maximum output current determines the minimum input-to-output voltage differential that the regulator can support. Also, the package's power dissipation limits the usable maximum input-to-output voltage differential. The maximum power-dissipation capability of the transistor's package and mounting must exceed the actual power dissipated in the device. The power dissipated equals the maximum load current ($I_{LOAD(MAX)_GL}$) multiplied by the maximum input-to-output voltage differential:

$$P_{NPN_GL} = (V_{GL} - V_{CN}) \times I_{LOAD(MAX)_GL}$$

where V_{GL} is the regulated output voltage on the collector of the transistor, V_{CN} is the inverting charge-pump

output voltage applied to the emitter of the transistor, and $I_{LOAD(MAX)_GL}$ is the maximum load current. Note that the external transistor is not short-circuit protected.

Stability Requirements

The device's negative-gate voltage regulator uses an internal transconductance amplifier to drive an external pass transistor. The transconductance amplifier, the pass transistor, the base-emitter resistor, and the output capacitor determine the loop stability.

The transconductance amplifier regulates the output voltage by controlling the pass transistor's base current. The total DC loop gain is approximately:

$$A_{V_GL} \cong \left(\frac{4}{V_T}\right) \times \left(1 + \frac{I_{BIAS} \times h_{FE}}{I_{LOAD}}\right) \times V_{REF}$$

where V_T is 26mV at room temperature, and I_{BIAS} is the current through the base-to-emitter resistor (R_{BE}). For the device, the bias current for the negative-gate voltage regulator is 0.1mA. Therefore, the base-to-emitter resistor should be chosen to set 0.1mA bias current:

$$R_{BE} = \frac{V_{BE}}{0.1mA} = \frac{0.7V}{0.1mA} = 7k\Omega$$

Use the closest standard resistor value of 6.8k Ω . The output capacitor and the load resistance create the dominant pole in the system. However, the internal amplifier delay, pass transistor's input capacitance, and the stray capacitance at the feedback node create additional poles in the system, and the output capacitor's ESR generates a zero. For proper operation, use the following equations to verify that the regulator is properly compensated:

- 1) First, determine the dominant pole set by the regulator's output capacitor and the load resistor:

$$f_{POLE_GL} = \frac{I_{LOAD(MAX)_GL}}{2\pi \times C_{OUT_GL} \times V_{OUT_GL}}$$

The unity-gain crossover frequency of the regulator is:

$$f_{CROSSOVER} = A_{V_GL} \times f_{POLE_GL}$$

- 2) The pole created by the internal amplifier delay is approximately 1MHz:

$$f_{POLE_AMP} = 1MHz$$

- 3) Next, calculate the pole set by the transistor's input capacitance, the transistor's input resistance, and the base-to-emitter pullup resistor:

Automotive TFT-LCD Power Supply with Boost Converter and Gate Voltage Regulators

$$f_{\text{POLE_IN}} = \frac{1}{2\pi \times C_{\text{IN}} \times (R_{\text{BE}}/R_{\text{IN}})}$$

where:

$$C_{\text{IN}} = \frac{g_m}{2\pi f_T}, R_{\text{IN}} = \frac{h_{\text{FE}}}{g_m}$$

g_m is the transconductance of the pass transistor, and f_T is the transition frequency. Both parameters can be found in the transistor's data sheet. Because R_{BE} is much greater than R_{IN} , the above equation can be simplified:

$$f_{\text{POLE_IN}} = \frac{1}{2\pi \times C_{\text{IN}} \times R_{\text{IN}}}$$

Substituting for C_{IN} and R_{IN} yields:

$$f_{\text{POLE}} = \frac{f_T}{h_{\text{FE}}}$$

- 4) Next, calculate the pole set by the regulator's feedback resistance and the capacitance between FBGL and GND (including stray capacitance):

$$f_{\text{POLE_FBGL}} = \frac{1}{2\pi \times C_{\text{FBGL}} \times (R_{\text{TOP}}/R_{\text{BOTTOM}})}$$

where C_{FBGL} is the capacitance between FBGL and GND and is equal to 30pF, R_{TOP} is the upper resistor of the regulator's feedback divider, and R_{BOTTOM} is the lower resistor of the divider.

- 5) Next, calculate the zero caused by the output capacitor's ESR:

$$f_{\text{ZERO_ESR}} = \frac{1}{2\pi \times C_{\text{OUT_LR}} \times R_{\text{ESR}}}$$

where R_{ESR} is the equivalent series resistance of $C_{\text{OUT_LR}}$. To ensure stability, make $C_{\text{OUT_LR}}$ large enough so the crossover occurs well before the poles and zero calculated in steps 2 to 5. The poles in steps 3 and 4 generally occur at several MHz and using ceramic capacitors ensures the ESR zero also occurs at several MHz. Placing the crossover frequency below 500kHz is sufficient to avoid the amplifier delay pole and generally works well, unless unusual component choices or extra capacitances move one of the other poles or the zero below 1MHz.

Table 4 is a list of recommended minimum output capacitance for the negative-gate voltage regulator and are applicable for output currents in the 10mA to 15mA range.

Table 4. Minimum Output Capacitance vs. Output Voltage Range for Negative-Gate Voltage Regulator ($I_{\text{OUT}} = 10\text{mA}$ to 15mA)

OUTPUT VOLTAGE RANGE	MINIMUM OUTPUT CAPACITANCE (μF)
$-2\text{V} \geq V_{\text{GL}} \geq -4\text{V}$	2.2
$-5\text{V} \geq V_{\text{GL}} \geq -7\text{V}$	1.5
$-8\text{V} \geq V_{\text{GL}} \geq -13\text{V}$	1

Applications Information

Power Dissipation

An IC's maximum power dissipation depends on the thermal resistance from the die to the ambient environment and the ambient temperature. The thermal resistance depends on the IC package, PCB copper area, other thermal mass, and airflow. More PCB copper, cooler ambient air, and more airflow increase the possible dissipation, while less copper or warmer air decreases the IC's dissipation capability. The major components of power dissipation are the power dissipated in the buck converter, boost converter, positive-gate voltage regulator, negative-gate voltage regulator, and the 1.8V/3.3V regulator controller.

Buck Converter

In the buck converter, conduction and switching losses in the internal MOSFET are dominant. Estimate these losses using the following formula:

$$P_{\text{LXB}} \approx [(I_{\text{OUTB}} \times \sqrt{D})^2 \times R_{\text{DS_ON(LXB)}}] + [0.5 \times V_{\text{INB}} \times I_{\text{OUTB}} \times (t_{\text{R}} + t_{\text{F}}) \times f_{\text{SWB}}]$$

where I_{OUTB} is the output current, D is the duty cycle of the buck converter, $R_{\text{DS_ON(LXB)}}$ is the on-resistance of the internal high-side FET, V_{INB} is the input voltage, $(t_{\text{R}} + t_{\text{F}})$ is the time it takes for the switch current and voltage to settle to their final values during the rising and falling transitions, and f_{SWB} is the switching frequency of the buck converter. $R_{\text{DS_ON(LXB)}}$ is 180m Ω (typ) and $(t_{\text{R}} + t_{\text{F}})$ is 4.4ns + 4.6ns = 9ns at $V_{\text{INB}} = 12\text{V}$.

Automotive TFT-LCD Power Supply with Boost Converter and Gate Voltage Regulators

Boost Converter

Power dissipation in the boost converter is primarily due to conduction and switching losses in the low-side FET. Conduction loss is produced by the inductor current flowing through the on-resistance of the FET during the on-time. Switching loss occurs during switching transitions and is a result of the finite time needed to fully turn on and off the FET. Power dissipation in the boost converter can be estimated with the following formula:

$$P_{LXP} \approx [(I_{IN(DC,MAX)} \times \sqrt{D})^2 \times R_{DS_ON(LXP)}] + V_{SH} \times I_{IN(DC,MAX)} \times f_{SW} \times [(t_{R-V} + t_{F-I}) + (t_{R-I} + t_{F-V})]$$

where $I_{IN(DC,MAX)}$ is the maximum expected average input (i.e., inductor) current, D is the duty cycle of the boost converter, $R_{DS_ON(LXP)}$ is the on-resistance of the internal low-side FET, V_{SH} is the output voltage, and f_{SW} is the switching frequency of the boost converter. $R_{DS_ON(LXP)}$ is 110mΩ (typ) and f_{SW} is 2.2MHz.

The voltage and current rise and fall times at the LXP node are equal to t_{R-V} (voltage rise time), t_{F-V} (voltage fall time), t_{R-I} (current rise time), and t_{F-I} (current fall time), and are determined as follows:

$$t_{R-V} = \frac{V_{SH} + V_{SCHOTTKY}}{K_{R-V}}$$

$$t_{F-V} = \frac{V_{SH} + V_{SCHOTTKY}}{K_{F-V}}$$

$$t_{R-I} = \frac{I_{IN(DC,MAX)}}{K_{R-I}}$$

$$t_{F-I} = \frac{I_{IN(DC,MAX)}}{K_{F-I}}$$

K_{R-V} , K_{F-V} , K_{R-I} , and K_{F-I} are the voltage and current slew rates of the LXP node and are supply dependent. Use [Table 5](#) to determine their values.

Positive-Gate Voltage Regulator

Use the lowest number of charge-pump stages possible in supplying power to the positive-gate voltage regulator. Doing so minimizes the drain-source voltage of the integrated pMOS switch and power dissipation. The power dissipated in the switch is given as:

$$P_{GH} = (V_{CP} - V_{GH}) \times I_{LOAD(MAX)_GH}$$

Ensure that the voltage on CP does not exceed the CP overvoltage threshold as given in the [Electrical Characteristics](#) table.

Negative-Gate Voltage Regulator

Use the lowest number of charge-pump stages possible to provide the negative voltage to the negative-gate voltage regulator. Estimate the power dissipated in the negative-gate voltage regulator using the following:

$$P_{GL} = (V_{INA} + |V_{CN1}| - V_{BE}) \times I_{DRVN}$$

where V_{BE} is the base-emitter voltage of the external npn bipolar transistor, and I_{DRVN} is the current sourced from DRVN to the R_{BE} bias resistor and to the base of the transistor, which is given by:

$$I_{DRVN} = \frac{V_{BE}}{R_{BE}} + \frac{I_{GL}}{h_{FE} + 1}$$

1.8V/3.3V Regulator Controller

The power dissipated in the 1.8V/3.3V regulator controller is given by:

$$P_{REG} = (V_{INA} - V_{OUT_REG} - V_{BE}) \times I_{DR}$$

where V_{OUT_REG} = 1.8V or 3.3V, V_{BE} is the base-emitter voltage of the external npn bipolar transistor, and I_{DR} is the current sourced from DR to the base of the transistor. I_{DR} is given by:

$$I_{DR} = \frac{I_{LOAD}}{h_{FE} + 1}$$

where I_{LOAD} is load current of the 1.8V/3.3V regulator controller, and h_{FE} is the current gain of the transistor.

Table 5. LXP Voltage and Current Slew Rates vs. Supply Voltage

V _{INA} (V)	LXP VOLTAGE AND CURRENT SLEW RATES			
	RISING VOLTAGE SLEW RATE K _{R-V} (V/ns)	FALLING VOLTAGE SLEW RATE K _{F-V} (V/ns)	RISING CURRENT SLEW RATE K _{R-I} (A/ns)	FALLING CURRENT SLEW RATE K _{F-I} (A/ns)
3.3	0.52	1.7	0.13	0.38
5	1.35	2	0.3	0.44

Automotive TFT-LCD Power Supply with Boost Converter and Gate Voltage Regulators

Total Power Dissipation

The total power dissipated in the package is the sum of the losses previously calculated. Therefore, total power dissipation can be estimated as follows:

$$P_T = P_{LXB} + P_{LXP} + P_{GH} + P_{GL} + P_{REG}$$

Achieve maximum heat transfer by connecting the exposed pad to a thermal landing pad and connecting the thermal landing pad to a large ground plane through thermal vias.

Layout Considerations

Careful PCB layout is critical in achieving stable and optimized performance. Follow the following guidelines for good PCB layout:

- 1) Place decoupling capacitors as close as possible to the device. Connect the power ground planes and the analog ground plane together at one point close to the device.

- 2) Connect input and output capacitors to the power ground planes; connect all other capacitors to the analog ground plane.
- 3) Keep the high-current paths as short and wide as possible. Keep the path of switching currents short.
- 4) Place the feedback resistors as close to the IC as possible. Connect the negative end of the resistive divider and the compensation network to the analog ground plane.
- 5) Route the high-speed switching node LXB and LXP away from sensitive analog nodes (FB, FBP, FBGH, FBGL, FBB, and REF).

Refer to the MAX16929 Evaluation Kit data sheet for a recommended PCB layout.

Ordering Information/Selector Guide

PART	REGULATOR V _{REG} (V)	BUCK V _{OUTB} (V)	BUCK I _{OUTB} (A)	BOOST I _{LIM} (A)	PIN-PACKAGE
MAX16929AGUI/V+	3.3	5	2	1.5	28 TSSOP-EP*
MAX16929BGUI/V+	1.8	5	2	1.5	28 TSSOP-EP*
MAX16929CGUI/V+	1.8	3.3	2	1.5	28 TSSOP-EP*
MAX16929DGUI/V+	3.3	5	2	0.75	28 TSSOP-EP*
MAX16929EGUI/V+	3.3	5	1.2	0.75	28 TSSOP-EP*
MAX16929FGUI/V+	1.8	5	2	0.75	28 TSSOP-EP*
MAX16929GGUI/V+	1.8	5	1.2	0.75	28 TSSOP-EP*
MAX16929HGUI/V+	1.8	3.3	2	0.75	28 TSSOP-EP*
MAX16929IGUI/V+	1.8	3.3	1.2	0.75	28 TSSOP-EP*

Note: All devices are specified over the -40°C to +105°C operating temperature range.

V denotes an automotive qualified part.

+Denotes a lead(Pb)-free/RoHS-compliant package.

*EP = Exposed pad.

Chip Information

PROCESS: BiCMOS

Package Information

For the latest package outline information and land patterns (footprints), go to www.maxim-ic.com/packages. Note that a "+", "#", or "-" in the package code indicates RoHS status only. Package drawings may show a different suffix character, but the drawing pertains to the package regardless of RoHS status.

PACKAGE TYPE	PACKAGE CODE	OUTLINE NO.	LAND PATTERN NO.
28 TSSOP-EP	U28ME+1	21-0108	90-0147

MAX16929

Automotive TFT-LCD Power Supply with Boost Converter and Gate Voltage Regulators

Typical Application Circuit

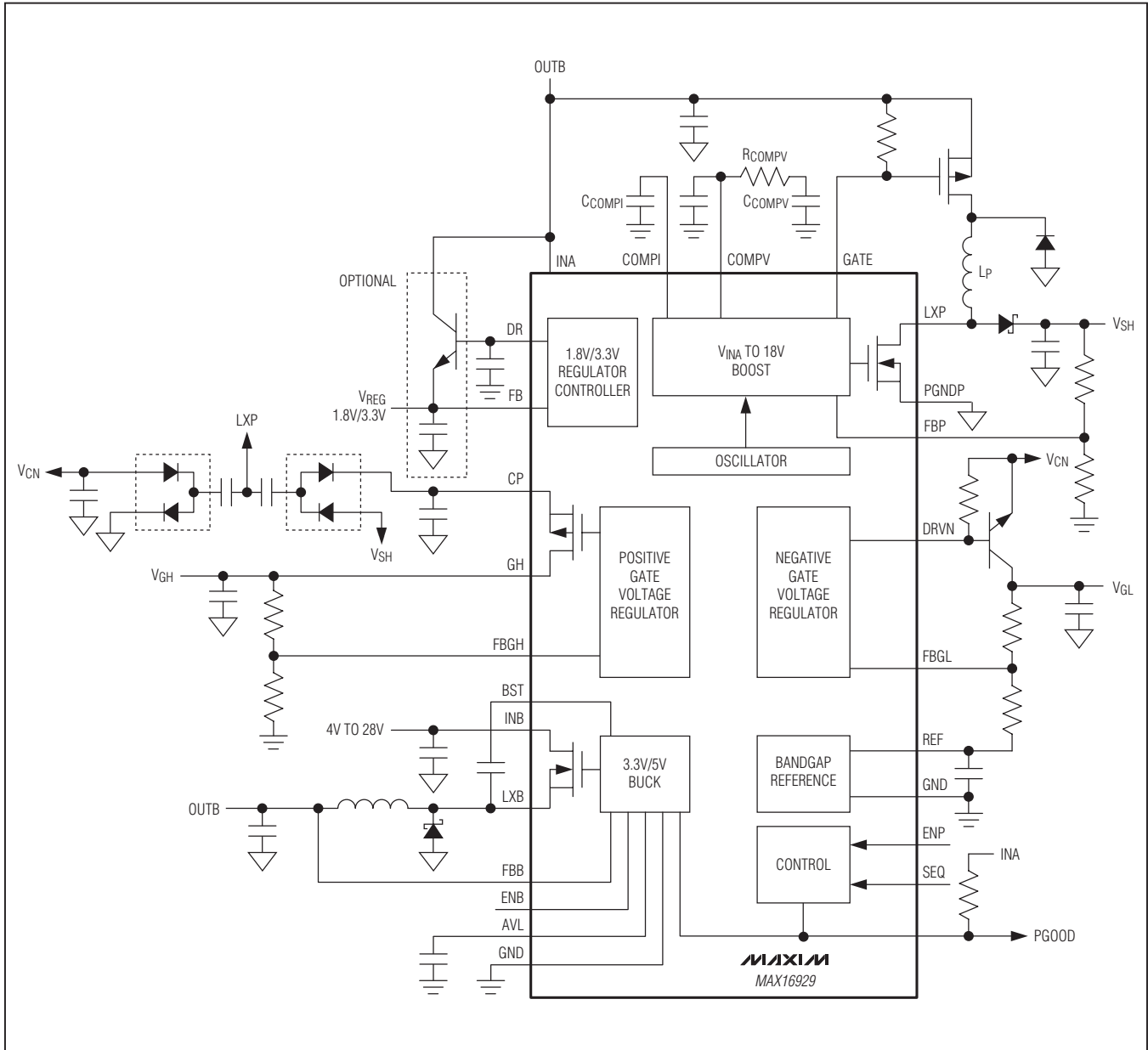

MAX16929

Automotive TFT-LCD Power Supply with Boost Converter and Gate Voltage Regulators

Revision History

REVISION NUMBER	REVISION DATE	DESCRIPTION	PAGES CHANGED
0	5/11	Initial release	—
1	9/11	Removed ENB from the FBB to GND range in the <i>Absolute Maximum Ratings</i>	2
2	1/12	Corrected the C_{COMP1} formula in the <i>Loop Compensation</i> section	18

Maxim cannot assume responsibility for use of any circuitry other than circuitry entirely embodied in a Maxim product. No circuit patent licenses are implied. Maxim reserves the right to change the circuitry and specifications without notice at any time. The parametric values (min and max limits) shown in the Electrical Characteristics table are guaranteed. Other parametric values quoted in this data sheet are provided for guidance.

Maxim Integrated Products, 120 San Gabriel Drive, Sunnyvale, CA 94086 408-737-7600 _____ **25**

Компания «Океан Электроники» предлагает заключение долгосрочных отношений при поставках импортных электронных компонентов на взаимовыгодных условиях!

Наши преимущества:

- Поставка оригинальных импортных электронных компонентов напрямую с производств Америки, Европы и Азии, а так же с крупнейших складов мира;
- Широкая линейка поставок активных и пассивных импортных электронных компонентов (более 30 млн. наименований);
- Поставка сложных, дефицитных, либо снятых с производства позиций;
- Оперативные сроки поставки под заказ (от 5 рабочих дней);
- Экспресс доставка в любую точку России;
- Помощь Конструкторского Отдела и консультации квалифицированных инженеров;
- Техническая поддержка проекта, помощь в подборе аналогов, поставка прототипов;
- Поставка электронных компонентов под контролем ВП;
- Система менеджмента качества сертифицирована по Международному стандарту ISO 9001;
- При необходимости вся продукция военного и аэрокосмического назначения проходит испытания и сертификацию в лаборатории (по согласованию с заказчиком);
- Поставка специализированных компонентов военного и аэрокосмического уровня качества (Xilinx, Altera, Analog Devices, Intersil, Interpoint, Microsemi, Actel, Aeroflex, Peregrine, VPT, Syfer, Eurofarad, Texas Instruments, MS Kennedy, Miteq, Cobham, E2V, MA-COM, Hittite, Mini-Circuits, General Dynamics и др.);

Компания «Океан Электроники» является официальным дистрибьютором и эксклюзивным представителем в России одного из крупнейших производителей разъемов военного и аэрокосмического назначения «JONHON», а так же официальным дистрибьютором и эксклюзивным представителем в России производителя высокотехнологичных и надежных решений для передачи СВЧ сигналов «FORSTAR».



JONHON

«JONHON» (основан в 1970 г.)

Разъемы специального, военного и аэрокосмического назначения:

(Применяются в военной, авиационной, аэрокосмической, морской, железнодорожной, горно- и нефтедобывающей отраслях промышленности)

«FORSTAR» (основан в 1998 г.)

ВЧ соединители, коаксиальные кабели, кабельные сборки и микроволновые компоненты:

(Применяются в телекоммуникациях гражданского и специального назначения, в средствах связи, РЛС, а так же военной, авиационной и аэрокосмической отраслях промышленности).



Телефон: 8 (812) 309-75-97 (многоканальный)

Факс: 8 (812) 320-03-32

Электронная почта: ocean@oceanchips.ru

Web: <http://oceanchips.ru/>

Адрес: 198099, г. Санкт-Петербург, ул. Калинина, д. 2, корп. 4, лит. А