

PRODUCT NO.
10018784-X0XXXX

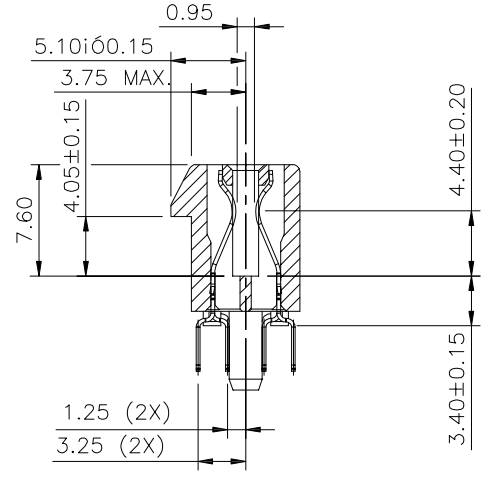

SECTION P-P



PLASTIC PEG TYPE

CONFIDENTIAL

mat'l. code				tolerances unless otherwise specified			CUSTOMER COPY	FCI		www.fciconnect.com	
ltr	ecn no	dr	date	linear	.X ± 0.30	projection		title PCI EXPRESS GEN3 CARD EDGE ASSY			
M	T05-0124	M W	06/07/05		.XX ± 0.20		product family		EDGE CARD	code	
N	T05-0153	M W	07/12/05	angles	.XXX ± 0.10		size		dwg no	TWN	
P	T05-0208	M W	09/15/05	dr	0° ±2°	scale		A4	sheet		
R	T06-0206	R C	12/01/06	enr	STONE LI 05/27/15	2:1		10018784		1 of 6	
S	ELX-DG-2161-1	S T	05/27/15	chr	STONE LI 05/27/15						
				appd	/ /						
					PM ZHENG 05/27/15						
sheet index	revision sheet	S 1	S 2	S 3	S 4	S 5	S 6				

cage code
22526

PRODUCT NO.
10018784-X1XXXX



METAL BOARD LOCKS TYPE

CONFIDENTIAL



mat'l. code				tolerances unless otherwise specified		CUSTOMER COPY	
ltr	ecn no	dr	date	linear	.X ± 0.30	projection	
				angles	.XX ± 0.20		
				dr	.XXX ± 0.10		
				enr	0° ±2°	MM	product family
				chr	STONE LI 05/27/15		EDGE CARD
				appd	STONE LI 05/27/15		code
					PM ZHENG 05/27/15	scale	TWN
sheet index	revision sheet					2:1	size
						A4	dwg no
							10018784
							sheet 2 of

		www.fciconnect.com	
title		PCI EXPRESS GEN3 CARD EDGE ASSY	
product family	EDGE CARD	code	TWN
size	dwg no	sheet	2 of
A4	10018784		



← I/O PANEL DIRECTION

RECOMMENDED FOOTPRINT

CONFIDENTIAL

mat'l. code				tolerances unless otherwise specified			CUSTOMER COPY		 www.fciconnect.com		
ltr	ecn no	dr	date	linear	.X ±		projection	title			
					.XX ±			PCI EXPRESS GEN3			
					.XXX ±			CARD EDGE ASS'Y			
				angles	0° ±2°		 MM	product family		code	
				dr	STONE LI	05/27/15		EDGE CARD		TWN	
				enr	STONE LI	05/27/15	size dwg no		sheet		
				chr	/	/	scale		3 of		
				appd	PM ZHENG	05/27/15	2:1		A4 10018784		
sheet index		revision sheet									

cage code
22526



SCALE 2:1

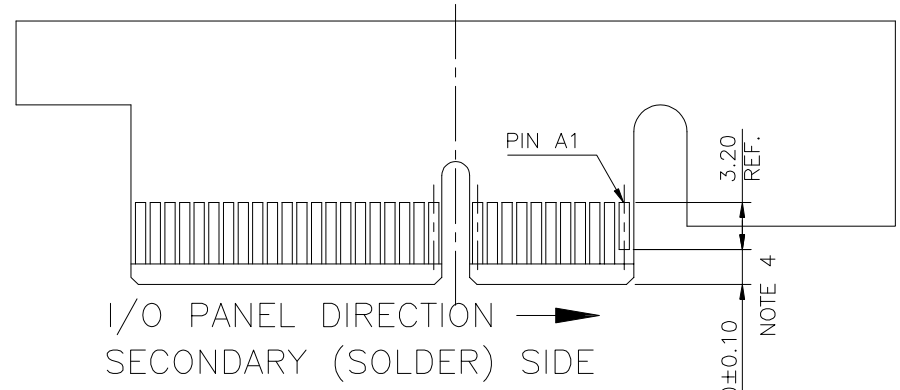

ADD-IN CARD EDGE-FINGER DIMENSIONS

#	POS	REF.	N	DIM "G"	"F"
36	6		6	8.15	B17
64	20		20	22.15	B31
98	37		37	39.15	B48
164	70		70	72.15	B81

PIN "F" SEE TABLE 2.40±0.10

CONFIDENTIAL

mat'l. code				tolerances unless otherwise specified				CUSTOMER COPY		 www.fciconnect.com	
ltr	ecn no	dr	date	linear	.X ±			projection	title		
					.XX ±				PCI EXPRESS GEN3		
					.XXX ±				CARD EDGE ASS'Y		
				angles	0° ±2°			 MM	product family		code
				dr	STONE LI	05/27/15	EDGE CARD		TWN		
				enr	STONE LI	05/27/15	size dwg no		sheet		
				chr	/	/	10018784		4 of		
				appd	PM ZHENG	05/27/15	scale	A4			
sheet index		revision sheet									

cage code 22526

NOTES:

1.MATERIAL:

HOUSING: NYLON, GLASS FILLED UL94V-0 RATE, SUITABLE FOR WAVE SOLDERING.

TERMINAL: COPPER ALLOY

PLATING: 50u" NICKEL UNDERPLATE ALL OVER
CONTACT AREA PLATING - SEE PRODUCT NUMBER CODE
SOLDER TAIL: TIN/LEAD (90/10) - SEE PRODUCT NUMBER CODE 100u" MIN. OVER 50u" NICKEL

METAL BOARD LOCKS: COPPER ALLOY
FINISH: 100u" TIN/LEAD (90/10) OVER 50u" NICKEL UNDERPLATE SEE PRODUCT NUMBER CODE

2.PRODUCT SPECIFICATION: GS-12-233

③THE HORIZONTAL AXIS FOR THE HOLE PATTERN IS ESTABLISHED BY A LINE THROUGH THE CENTER OF THE TWO Ø2.35 HOLES.
THE VERTICAL AXIS IS 90° TO THE HORIZONTAL AXIS, THROUGH THE CENTER OF DATUM Z.

④NO TIE BAR PERMITTED FROM CARD EDGE TO LEADING EDGE OF PAD FOR PINS A1 AND PIN NUMBERS "F".

⑤CHAMFER EDGES MUST BE FREE OF CUTTING BURRS.

⑥FREQUENCY & LOCATION AT SUPPLIER DISCRETION. RIDGE MAY BE CONTINUOUS WITH NO BREAKS.

7.RoHS COMPATIBLE PRODUCT SPECIFICATIONS

a - PLATING:

- "LF" MEANS THE PRODUCT IS LEAD-FREE, 2um MINIMUM MATTE TIN OVER 1.27um MINIMUM NICKEL UNDERPLATE.

b - MANUFACTURING PROCESS COMPATIBILITY

- THE HOUSING WILL WITHSTAND EXPOSURE TO 260°C±5°C SOLDER BATH TEMPERATURE FOR 5 SECONDS IN A WAVE SOLDER APPLICATION WITH A 1.6mm MIN THICK CIRCUIT BOARD.
- THE HOUSING WILL WITHSTAND EXPOSURE TO 240°C±5°C SOLDER BATH TEMPERATURE FOR 5 SECONDS IN A WAVE SOLDER APPLICATION WITH A 1.6mm MIN THICK CIRCUIT BOARD.(For 10018784-X 0 X X X X(X X) options)

CONNECTOR	# POS REF.	N	DIM "A"	DIM "B"	DIM "C"	"E"
1 PORT	36	6	7.65	25.00	9.15	6.00
4 PORT	64	20	21.65	39.00	23.15	20.00
8 PORT	98	37	38.65	56.00	40.15	37.00
16 PORT	164	70	71.65	89.00	73.15	70.00

PRODUCT NUMBER CODE
10018784-X X X X X X □ □

HOUSING COLOR OPTIONS

- 0-WHITE
- 1-BLACK

PEGS OPTIONS

- 0-PLASTIC PEGS
- 1-METAL BOARD LOCKS

TERMINAL PLATING OPTIONS

- 0-50u" Ni UNDERPLATE
30u" Au CONTACT AREA
100u" TIN TAIL AREA ----- COMPATIBLE RoHS
- 1-50u" Ni UNDERPLATE
15u" Au CONTACT AREA
100u" TIN TAIL AREA ----- COMPATIBLE RoHS
- 2-50u" Ni UNDERPLATE
GOLD FLASH CONTACT AREA
100u" TIN TAIL AREA ----- COMPATIBLE RoHS
- 3-50u" Ni UNDERPLATE
30u" Au CONTACT AREA
100u" TIN/LEAD TAIL AREA ----- INCOMPLIANT RoHS
- 4-50u" Ni UNDERPLATE
15u" Au CONTACT AREA
100u" TIN/LEAD TAIL AREA ----- INCOMPLIANT RoHS
- 5-50u" Ni UNDERPLATE
GOLD FLASH CONTACT AREA
100u" TIN/LEAD TAIL AREA ----- INCOMPLIANT RoHS

LEAD FREE OPTION

LEAVE BLANK FOR TERMINAL PLATING 3,4,5
"LF" FOR TERMINAL PLATING OPTION 0,1,2

POS OPTIONS

- 0-36
- 1-64
- 2-98
- 3-164

PACKAGING OPTIONS

T-TRAY PACKAGING
M-TRAY PACKAGING & MYLAR TAPE FOR PICK-N-PLACE. SEE FIGURE 1

TAIL LENGTH OPTIONS

	DIM "D"	PCB THICKNESS	BOARD LOCKS DIM"G"
0	2.30 ^{+0.25} / _{-0.13}	1.56±0.10	1.70±0.15
1	3.10 ^{+0.25} / _{-0.13}	2.36±0.10	2.50±0.15

CONFIDENTIAL



www.fciconnect.com

CUSTOMER COPY

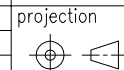

title PCI EXPRESS GEN3 CARD EDGE ASS'Y

product family EDGE CARD

code TWN

size A4

dwg no 10018784 sheet 5 of

scale 1:1



mat'l. code				tolerances unless otherwise specified			CUSTOMER COPY	
ltr	ecn no	dr	date	linear	.X ±	projection		
					.XX ±			
					.XXX ±			
				angles	0° ±2°	MM		
				dr	STONE LI 05/27/15			
				enr	STONE LI 05/27/15			
				chr	/ /			
				appd	PM ZHENG 05/27/15			
sheet index	revision sheet							

cage code 22526

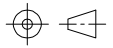

FIGURE 1

CONFIDENTIAL

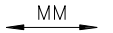
mat'l. code				tolerances unless otherwise specified			CUSTOMER COPY	 www.fciconnect.com		
ltr	ecn no	dr	date	linear	.X ± 0.25	projection				
					.XX ± 0.13		title			
				angles	.XXX ± 0.05		PCI EXPRESS GEN3 CARD EDGE ASS'Y 			
				dr	STONE LI	05/27/15		product family		code
				enr	STONE LI	05/27/15		EDGE CARD		TWN
				chr	/	/	scale	size		sheet
				appd	PM ZHENG	05/27/15		1.5:1	A4	10018784
sheet index		revision sheet								

cage code 22526

Компания «Океан Электроники» предлагает заключение долгосрочных отношений при поставках импортных электронных компонентов на взаимовыгодных условиях!

Наши преимущества:

- Поставка оригинальных импортных электронных компонентов напрямую с производств Америки, Европы и Азии, а так же с крупнейших складов мира;
- Широкая линейка поставок активных и пассивных импортных электронных компонентов (более 30 млн. наименований);
- Поставка сложных, дефицитных, либо снятых с производства позиций;
- Оперативные сроки поставки под заказ (от 5 рабочих дней);
- Экспресс доставка в любую точку России;
- Помощь Конструкторского Отдела и консультации квалифицированных инженеров;
- Техническая поддержка проекта, помощь в подборе аналогов, поставка прототипов;
- Поставка электронных компонентов под контролем ВП;
- Система менеджмента качества сертифицирована по Международному стандарту ISO 9001;
- При необходимости вся продукция военного и аэрокосмического назначения проходит испытания и сертификацию в лаборатории (по согласованию с заказчиком);
- Поставка специализированных компонентов военного и аэрокосмического уровня качества (Xilinx, Altera, Analog Devices, Intersil, Interpoint, Microsemi, Actel, Aeroflex, Peregrine, VPT, Syfer, Eurofarad, Texas Instruments, MS Kennedy, Miteq, Cobham, E2V, MA-COM, Hittite, Mini-Circuits, General Dynamics и др.);

Компания «Океан Электроники» является официальным дистрибьютором и эксклюзивным представителем в России одного из крупнейших производителей разъемов военного и аэрокосмического назначения «JONHON», а так же официальным дистрибьютором и эксклюзивным представителем в России производителя высокотехнологичных и надежных решений для передачи СВЧ сигналов «FORSTAR».



JONHON

«JONHON» (основан в 1970 г.)

Разъемы специального, военного и аэрокосмического назначения:

(Применяются в военной, авиационной, аэрокосмической, морской, железнодорожной, горно- и нефтедобывающей отраслях промышленности)

«FORSTAR» (основан в 1998 г.)

ВЧ соединители, коаксиальные кабели, кабельные сборки и микроволновые компоненты:

(Применяются в телекоммуникациях гражданского и специального назначения, в средствах связи, РЛС, а так же военной, авиационной и аэрокосмической отраслях промышленности).



Телефон: 8 (812) 309-75-97 (многоканальный)

Факс: 8 (812) 320-03-32

Электронная почта: ocean@oceanchips.ru

Web: <http://oceanchips.ru/>

Адрес: 198099, г. Санкт-Петербург, ул. Калинина, д. 2, корп. 4, лит. А