

PRODUCT NO.  
10018784-X0XXXX

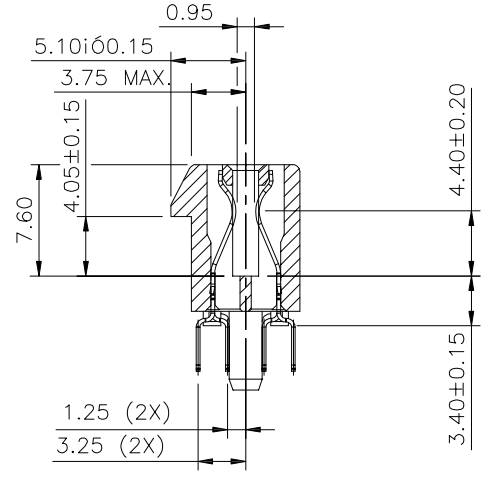

SECTION P-P



PLASTIC PEG TYPE

CONFIDENTIAL

mat'l. code				tolerances unless otherwise specified			CUSTOMER COPY		 www.fciconnect.com		
ltr	ecn no	dr	date	linear	.X ± 0.30			projection	title		
M	T05-0124	M W	06/07/05		.XX ± 0.20				PCI EXPRESS GEN3		
N	T05-0153	M W	07/12/05		.XXX ± 0.10				CARD EDGE ASSY		
P	T05-0208	M W	09/15/05	angles	0° ± 2°			 MM scale 2:1	product family		code
R	T06-0206	R C	12/01/06	dr	STONE LI	05/27/15	EDGE CARD		TWN		
S	ELX-DG-2161-1	S T	05/27/15	enrg	STONE LI	05/27/15	size		dwg no	sheet	
				chr	/	/	A4		10018784		1 of 6
				appd	PM ZHENG	05/27/15					
sheet index	revision sheet	S 1	S 2	S 3	S 4	S 5	S 6				

cage code  
22526

PRODUCT NO.  
10018784-X1XXXX

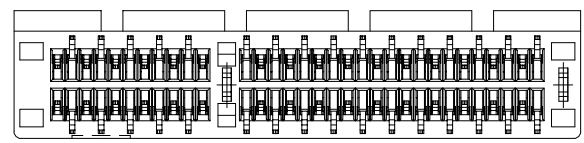

METAL BOARD LOCKS TYPE

CONFIDENTIAL

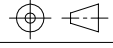
mat'l. code				tolerances unless otherwise specified		CUSTOMER COPY		 www.fciconnect.com	
ltr	ecn no	dr	date	linear	.X ± 0.30	projection	title		
				angles	.XX ± 0.20		PCI EXPRESS GEN3 CARD EDGE ASSY		
				dr	.XXX ± 0.10	MM	product family	EDGE CARD	code
				enr	0° ±2°	←	size	dwg no	TWN
				chr		→	A4	10018784	sheet
				appd		scale			2 of
sheet index	revision sheet					2:1			

cage code  
22526



← I/O PANEL DIRECTION

RECOMMENDED FOOTPRINT

CONFIDENTIAL

mat'l. code				tolerances unless otherwise specified			CUSTOMER COPY	 www.fciconnect.com		
ltr	ecn no	dr	date	linear	.X ±	projection				
					.XX ±	 MM		title		code
				angles	.XXX ±			PCI EXPRESS GEN3		
				dr	0° ±2°	scale	EDGE CARD		sheet	
				enr		2:1	size   dwg no			3 of
				chr		A4	10018784			
				appd						
sheet index	revision sheet									

cage code  
22526



SCALE 2:1

I/O PANEL DIRECTION  
PRIMARY (COMPONENT) SIDE



I/O PANEL DIRECTION  
SECONDARY (SOLDER) SIDE

ADD-IN CARD EDGE-FINGER DIMENSIONS

CONFIDENTIAL

#	POS	REF.	N	DIM "G"	"F"
36	6		8.15	B17	
64	20		22.15	B31	
98	37		39.15	B48	
164	70		72.15	B81	

PIN "F" SEE TABLE 2.40±0.10  
NOTE 4

mat'l. code				tolerances unless otherwise specified		CUSTOMER COPY	 www.fciconnect.com	
ltr	ecn no	dr	date	linear	.X ±			
					.XX ±	projection	title PCI EXPRESS GEN3 CARD EDGE ASS'Y	
				angles	.XXX ±			
				dr	0° ±2°	 MM	product family	
				enr			EDGE CARD	code
				chr		scale	size	
				appd			2:1	dwg no
sheet index		revision sheet		PM ZHENG 05/27/15		A4	10018784	
								sheet 4 of

cage code  
22526

NOTES:

1.MATERIAL:

HOUSING: NYLON, GLASS FILLED UL94V-0 RATE, SUITABLE FOR WAVE SOLDERING.

TERMINAL: COPPER ALLOY

PLATING: 50u" NICKEL UNDERPLATE ALL OVER CONTACT AREA PLATING - SEE PRODUCT NUMBER CODE SOLDER TAIL: TIN/LEAD (90/10) - SEE PRODUCT NUMBER CODE 100u" MIN. OVER 50u" NICKEL

METAL BOARD LOCKS: COPPER ALLOY FINISH: 100u" TIN/LEAD (90/10) OVER 50u" NICKEL UNDERPLATE SEE PRODUCT NUMBER CODE

2.PRODUCT SPECIFICATION: GS-12-233

③THE HORIZONTAL AXIS FOR THE HOLE PATTERN IS ESTABLISHED BY A LINE THROUGH THE CENTER OF THE TWO Ø2.35 HOLES. THE VERTICAL AXIS IS 90° TO THE HORIZONTAL AXIS, THROUGH THE CENTER OF DATUM Z.

④NO TIE BAR PERMITTED FROM CARD EDGE TO LEADING EDGE OF PAD FOR PINS A1 AND PIN NUMBERS "F".

⑤CHAMFER EDGES MUST BE FREE OF CUTTING BURRS.

⑥FREQUENCY & LOCATION AT SUPPLIER DISCRETION. RIDGE MAY BE CONTINUOUS WITH NO BREAKS.

7.RoHS COMPATIBLE PRODUCT SPECIFICATIONS

a - PLATING:

- "LF" MEANS THE PRODUCT IS LEAD-FREE, 2um MINIMUM MATTE TIN OVER 1.27um MINIMUM NICKEL UNDERPLATE.

b - MANUFACTURING PROCESS COMPATIBILITY

- THE HOUSING WILL WITHSTAND EXPOSURE TO 260°C±5°C SOLDER BATH TEMPERATURE FOR 5 SECONDS IN A WAVE SOLDER APPLICATION WITH A 1.6mm MIN THICK CIRCUIT BOARD.

- THE HOUSING WILL WITHSTAND EXPOSURE TO 240°C±5°C SOLDER BATH TEMPERATURE FOR 5 SECONDS IN A WAVE SOLDER APPLICATION WITH A 1.6mm MIN THICK CIRCUIT BOARD.(For 10018784-X 0 X X X X(X X) options)

CONNECTOR	# POS REF.	N	DIM "A"	DIM "B"	DIM "C"	"E"
1 PORT	36	6	7.65	25.00	9.15	6.00
4 PORT	64	20	21.65	39.00	23.15	20.00
8 PORT	98	37	38.65	56.00	40.15	37.00
16 PORT	164	70	71.65	89.00	73.15	70.00

PRODUCT NUMBER CODE  
10018784-X X X X X X □ □

HOUSING COLOR OPTIONS

- 0-WHITE
- 1-BLACK

PEGS OPTIONS

- 0-PLASTIC PEGS
- 1-METAL BOARD LOCKS

TERMINAL PLATING OPTIONS

- 0-50u" Ni UNDERPLATE  
30u" Au CONTACT AREA  
100u" TIN TAIL AREA ----- COMPATIBLE RoHS
- 1-50u" Ni UNDERPLATE  
15u" Au CONTACT AREA  
100u" TIN TAIL AREA ----- COMPATIBLE RoHS
- 2-50u" Ni UNDERPLATE  
GOLD FLASH CONTACT AREA  
100u" TIN TAIL AREA ----- COMPATIBLE RoHS
- 3-50u" Ni UNDERPLATE  
30u" Au CONTACT AREA  
100u" TIN/LEAD TAIL AREA ----- INCOMPLIANT RoHS
- 4-50u" Ni UNDERPLATE  
15u" Au CONTACT AREA  
100u" TIN/LEAD TAIL AREA ----- INCOMPLIANT RoHS
- 5-50u" Ni UNDERPLATE  
GOLD FLASH CONTACT AREA  
100u" TIN/LEAD TAIL AREA ----- INCOMPLIANT RoHS

LEAD FREE OPTION

LEAVE BLANK FOR TERMINAL PLATING 3,4,5  
"LF" FOR TERMINAL PLATING OPTION 0,1,2

POS OPTIONS

- 0-36
- 1-64
- 2-98
- 3-164

PACKAGING OPTIONS

T-TRAY PACKAGING  
M-TRAY PACKAGING & MYLAR TAPE FOR PICK-N-PLACE. SEE FIGURE 1

TAIL LENGTH OPTIONS

	DIM "D"	PCB THICKNESS	BOARD LOCKS DIM"G"
0	2.30 ±0.25 ±0.13	1.56±0.10	1.70±0.15
1	3.10 ±0.25 ±0.13	2.36±0.10	2.50±0.15

CONFIDENTIAL



www.fciconnect.com

CUSTOMER COPY

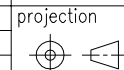

title PCI EXPRESS GEN3 CARD EDGE ASS'Y

product family EDGE CARD

code TWN

size A4

dwg no 10018784 sheet 5 of

scale 1:1



mat'l. code				tolerances unless otherwise specified			CUSTOMER COPY	
ltr	ecn no	dr	date	linear	.X ±	projection		
					.XX ±			
					.XXX ±			
				angles	0° ±2°	MM ← →		
				dr	STONE LI 05/27/15			
				enr	STONE LI 05/27/15			
				chr	/ /			
				appd	PM ZHENG 05/27/15			
sheet index	revision sheet							

cage code 22526

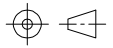

FIGURE 1

CONFIDENTIAL

mat'l. code				tolerances unless otherwise specified			CUSTOMER COPY	 www.fciconnect.com								
ltr	ecn no	dr	date	linear	.X ± 0.25						projection	 title				
					.XX ± 0.13											
					.XXX ± 0.05											
				angles	0° ± 2°		 MM	product family EDGE CARD size dwg no		code						
				dr	STONE LI	05/27/15				scale	A4		TWN			
				enr	STONE LI	05/27/15							1.5:1	10018784		sheet
				chr	/	/										6 of
				appd	PM ZHENG	05/27/15										
sheet index	revision sheet															

cage code 22526

Компания «Океан Электроники» предлагает заключение долгосрочных отношений при поставках импортных электронных компонентов на взаимовыгодных условиях!

Наши преимущества:

- Поставка оригинальных импортных электронных компонентов напрямую с производств Америки, Европы и Азии, а так же с крупнейших складов мира;
- Широкая линейка поставок активных и пассивных импортных электронных компонентов (более 30 млн. наименований);
- Поставка сложных, дефицитных, либо снятых с производства позиций;
- Оперативные сроки поставки под заказ (от 5 рабочих дней);
- Экспресс доставка в любую точку России;
- Помощь Конструкторского Отдела и консультации квалифицированных инженеров;
- Техническая поддержка проекта, помощь в подборе аналогов, поставка прототипов;
- Поставка электронных компонентов под контролем ВП;
- Система менеджмента качества сертифицирована по Международному стандарту ISO 9001;
- При необходимости вся продукция военного и аэрокосмического назначения проходит испытания и сертификацию в лаборатории (по согласованию с заказчиком);
- Поставка специализированных компонентов военного и аэрокосмического уровня качества (Xilinx, Altera, Analog Devices, Intersil, Interpoint, Microsemi, Actel, Aeroflex, Peregrine, VPT, Syfer, Eurofarad, Texas Instruments, MS Kennedy, Miteq, Cobham, E2V, MA-COM, Hittite, Mini-Circuits, General Dynamics и др.);

Компания «Океан Электроники» является официальным дистрибьютором и эксклюзивным представителем в России одного из крупнейших производителей разъемов военного и аэрокосмического назначения «JONHON», а так же официальным дистрибьютором и эксклюзивным представителем в России производителя высокотехнологичных и надежных решений для передачи СВЧ сигналов «FORSTAR».



## JONHON

«JONHON» (основан в 1970 г.)

Разъемы специального, военного и аэрокосмического назначения:

(Применяются в военной, авиационной, аэрокосмической, морской, железнодорожной, горно- и нефтедобывающей отраслях промышленности)

«FORSTAR» (основан в 1998 г.)

ВЧ соединители, коаксиальные кабели, кабельные сборки и микроволновые компоненты:

(Применяются в телекоммуникациях гражданского и специального назначения, в средствах связи, РЛС, а так же военной, авиационной и аэрокосмической отраслях промышленности).



Телефон: 8 (812) 309-75-97 (многоканальный)

Факс: 8 (812) 320-03-32

Электронная почта: [ocean@oceanchips.ru](mailto:ocean@oceanchips.ru)

Web: <http://oceanchips.ru/>

Адрес: 198099, г. Санкт-Петербург, ул. Калинина, д. 2, корп. 4, лит. А