

Cree® PLCC6 3 in 1 SMD LED CLP6C-RKW/AKW



PRODUCT DESCRIPTION

These SMD LEDs are packaged in the industry standard CLPP6 package. These high-reliability and high-brightness LEDs are designed to work in a wide range of environmental conditions and are ideally suited for use in illumination applications.

Their wide viewing angle makes these LEDs ideally suited for channel letter, or general backlighting and illumination applications. The flat top emitting surface makes it easy for these LEDs to mate with light pipes.

FEATURES

- Size (mm): 6.0 x 5.0
- Color and Typical Dominant Wavelength:
Red (618-630nm)
Amber (584-596nm)
- Luminous Intensity (mcd)
CLP6C-RKW: (3550 - 7100)
CLP6C-AKW: (3550-9000)
- Lead-Free
- RoHS Compliant

APPLICATIONS

- Channel Letter
- Backlight

ABSOLUTE MAXIMUM RATINGS ($T_A = 25^\circ\text{C}$)

Items	Symbol	Absolute Maximum Rating	Unit
		Red/Amber	
Forward Current	I_F	3 x 80	mA
Peak Forward Current ^{Note}	I_{FP}	3 x 200	mA
Reverse Voltage	V_R	5	V
Power Dissipation	P_D	3 x 240	mW
Operation Temperature	T_{opr}	-40 ~ +100	$^\circ\text{C}$
Storage Temperature	T_{stg}	-40 ~ +100	$^\circ\text{C}$
Junction Temperature	T_J	110	$^\circ\text{C}$
Junction/Ambient	R_{THJA}	3 x 250	$^\circ\text{C/W}$
Junction/Solder Point	R_{THJS}	3 x 150	$^\circ\text{C/W}$
Electrostatic Discharge Classification(MIL-STD-883E)	ESD	Class 2	

Note: Pulse width ≤ 0.1 msec, duty $\leq 1/10$.

TYPICAL ELECTRICAL & OPTICAL CHARACTERISTICS ($T_A = 25^\circ\text{C}$)

Characteristics	Color	Symbol	Condition	Unit	Minimum	Typical	Maximum
Forward Voltage	Red/Amber	V_F	$I_F = 50$ mA	V		2.4	3.0
Reverse Current	Red/Amber	I_R	$V_R = 5$ V	μA			10
Dominant Wavelength	Red	λ_D	$I_F = 3 \times 50$ mA	nm	618	624	630
	Amber	λ_D	$I_F = 3 \times 50$ mA	nm	584	591	596
Luminous Intensity	Red	I_v	$I_F = 3 \times 50$ mA	mcd	3550	4800	
	Amber	I_v	$I_F = 3 \times 50$ mA	mcd	3550	5000	

Note: Continuous reverse voltage can cause LED damage.

INTENSITY BIN LIMIT ($I_F = 3 \times 50 \text{ mA}$)

Red (CLP6C-RKW)

Bin Code	Min.(mcd)	Max.(mcd)
Yb	3550	4500
Z0	4500	5600
A0	5600	7100

Amber (CLP6C-AKW)

Bin Code	Min.(mcd)	Max.(mcd)
Yb	3550	4500
Z0	4500	5600
A0	5600	7100
B0	7100	9000

Tolerance of measurement of luminous intensity is $\pm 10\%$.

COLOR BIN LIMIT ($I_F = 3 \times 50 \text{ mA}$)

Red (CLP6C-RKW)

Bin Code	Min.(nm)	Max.(nm)
RA	618	630

Amber (CLP6C-AKW)

Bin Code	Min.(nm)	Max.(nm)
AA	584	596

Tolerance of measurement of dominant wavelength is $\pm 1 \text{ nm}$.

ORDER CODE TABLE*

Color	Kit Number	Luminous Intensity (mcd)		Dominant Wavelength			
		Min.	Max.	Color Bin	Min.(nm)	Color Bin	Max.(nm)
Red	CLP6C-RKW-CYb0AA3	3550	7100	RA	618	RA	630
Red	CLP6C-RKW-CZ0A0AA3	4500	7100	RA	618	RA	630

Color	Kit Number	Luminous Intensity (mcd)		Dominant Wavelength			
		Min.	Max.	Color Bin	Min.(nm)	Color Bin	Max.(nm)
Amber	CLP6C-AKW-CYb0AA3	3550	9000	AA	584	AA	596
Amber	CLP6C-AKW-CZ0B0AA3	4500	9000	AA	584	AA	596

Notes:

1. The above kit numbers represent order codes that include multiple intensity-bin and color-bin codes. Only one intensity-bin code and one color-bin code will be shipped on each bulk. Single intensity-bin code and single color-bin codes will not be orderable.
2. Please refer to the "Cree LED Lamp Reliability Test Standards" document #1 for reliability test conditions.
3. Please refer to the "Cree LED Lamp Soldering & Handling" document #2 for information about how to use this LED product safely.

#1: Refer to http://www.cree.com/led-components/media/documents/LED_Lamp_Reliability_Test_Standard.pdf

#2: Refer to <http://www.cree.com/led-components/media/documents/sh-HB.pdf>

GRAPHS

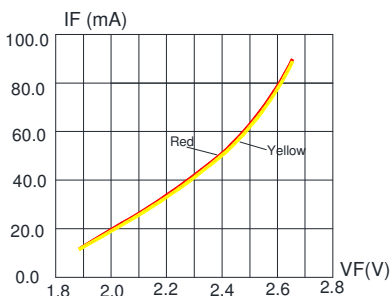

FIG.1 FORWARD CURRENT VS. FORWARD VOLTAGE.

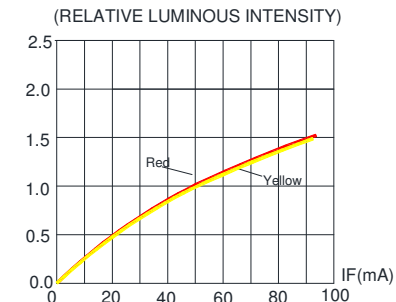

FIG.2 RELATIVE LUMINOUS INTENSITY VS. FORWARD CURRENT

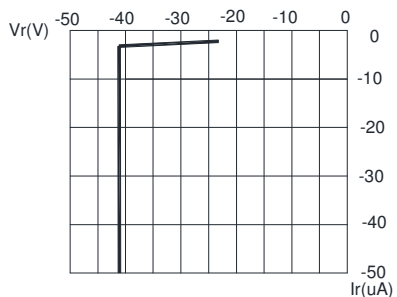

FIG.3 RED & YELLOW REVERSE CURRENT VS. REVERSE VOLTAGE.

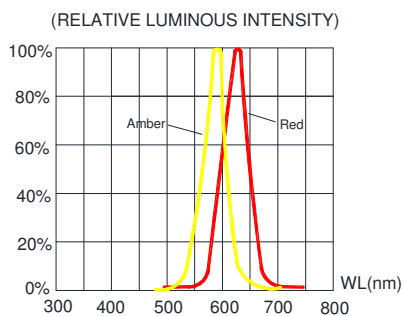

FIG.4 RELATIVE LUMINOUS INTENSITY VS. WAVELENGTH.

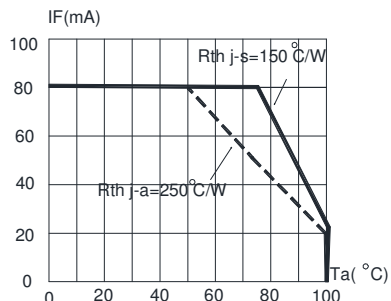

FIG.5 RED & YELLOW MAXIMUM FORWARD DC CURRENT VS AMBIENT TEMPERATURE ($T_{jmax}=110^{\circ}C$)

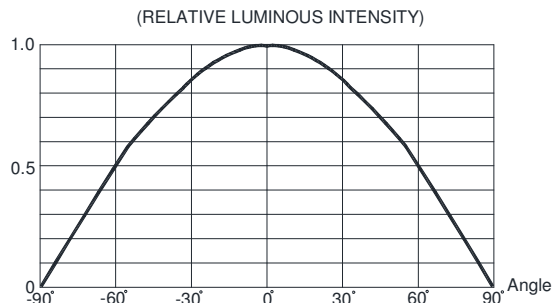
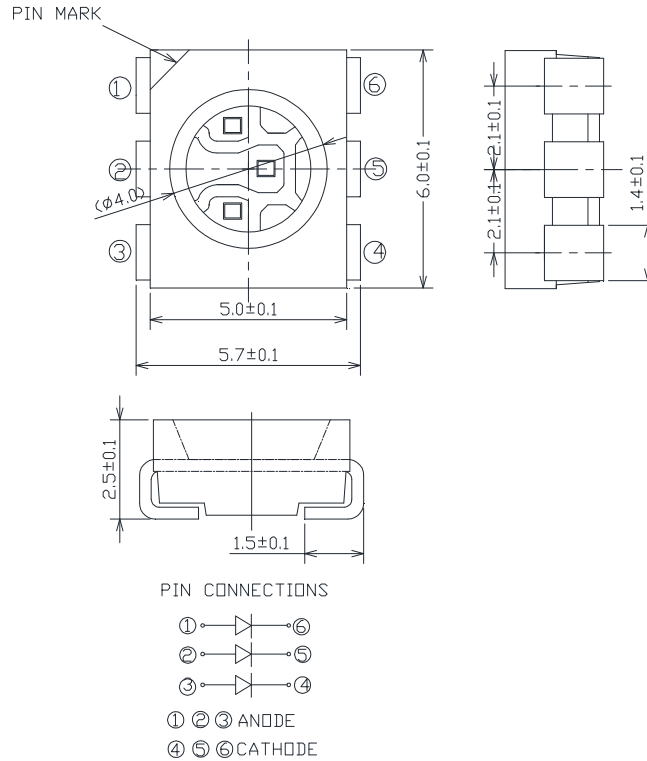

FIG.6 FAR FIELD PATTERN

The above data are collected from statistical figures that do not necessarily correspond to the actual parameters of each single LED. Hence, these data will be changed without further notice.

MECHANICAL DIMENSIONS

All dimensions are in mm.



NOTES

RoHS Compliance

The levels of environmentally sensitive, persistent biologically toxic (PBT), persistent organic pollutants (POP), or otherwise restricted materials in this product are below the maximum concentration values (also referred to as the threshold limits) permitted for such substances, or are used in an exempted application, in accordance with EU Directive 2002/95/EC on the restriction of the use of certain hazardous substances in electrical and electronic equipment (RoHS), as amended through April 21, 2006.

Vision Advisory Claim

Users should be cautioned not to stare at the light of this LED product. The bright light can damage the eye.

KIT NUMBER SYSTEM

Cree LED lamps are tested and sorted into performance bins. A bin is specified by ranges of color, forward voltage, and brightness. Sorted LEDs are packaged for shipping in various convenient options. Please refer to the "Cree LED Lamp Packaging Standard" document for more information about shipping and packaging options.

Cree LEDs are sold by order codes in combinations of bins called kits. Order codes are configured in the following manner:



REFLOW SOLDERING

- The CLP6C-RKW AKW is rated as a MSL 5a product.
- The recommended floor life out of bag is 24hrs.
- The temperature profile is as below.



Use only with CLP6C-RKW AKW

Solder
Average ramp-up rate = 4°C/s max
Preheat temperature = 150°C ~200°C
Preheat time = 120s max
Ramp-down rate = 6°C/s max
Peak temperature = 235°C max
Time within 5°C of actual Peak Temperature = 10s max
Duration above 217°C is 45s max

Refer to "<http://www.cree.com/led-components/media/documents/sh-HB.pdf>" for soldering & handling details.

NOTES

- The packaging sizes of these SMD products are very small and the resin is still soft after solidification. Users are required to handle with care. Never touch the resin surface of SMD products.
- To avoid damaging the product's surface and interior device, it is recommended to choose a special nozzle to pick up the SMD products during the process of SMT production. If handling is necessary, take special care when picking up these products. The following method is necessary:



PACKAGING

- The boxes are not water-resistant, and they must be kept away from water and moisture.
- The LEDs are packed in cardboard boxes after packaging in normal or anti-electrostatic bags.
- Cardboard boxes will be used to protect the LEDs from mechanical shocks during transportation.
- The reel pack is applied in SMD LED.
- Max 900 pcs per reel.

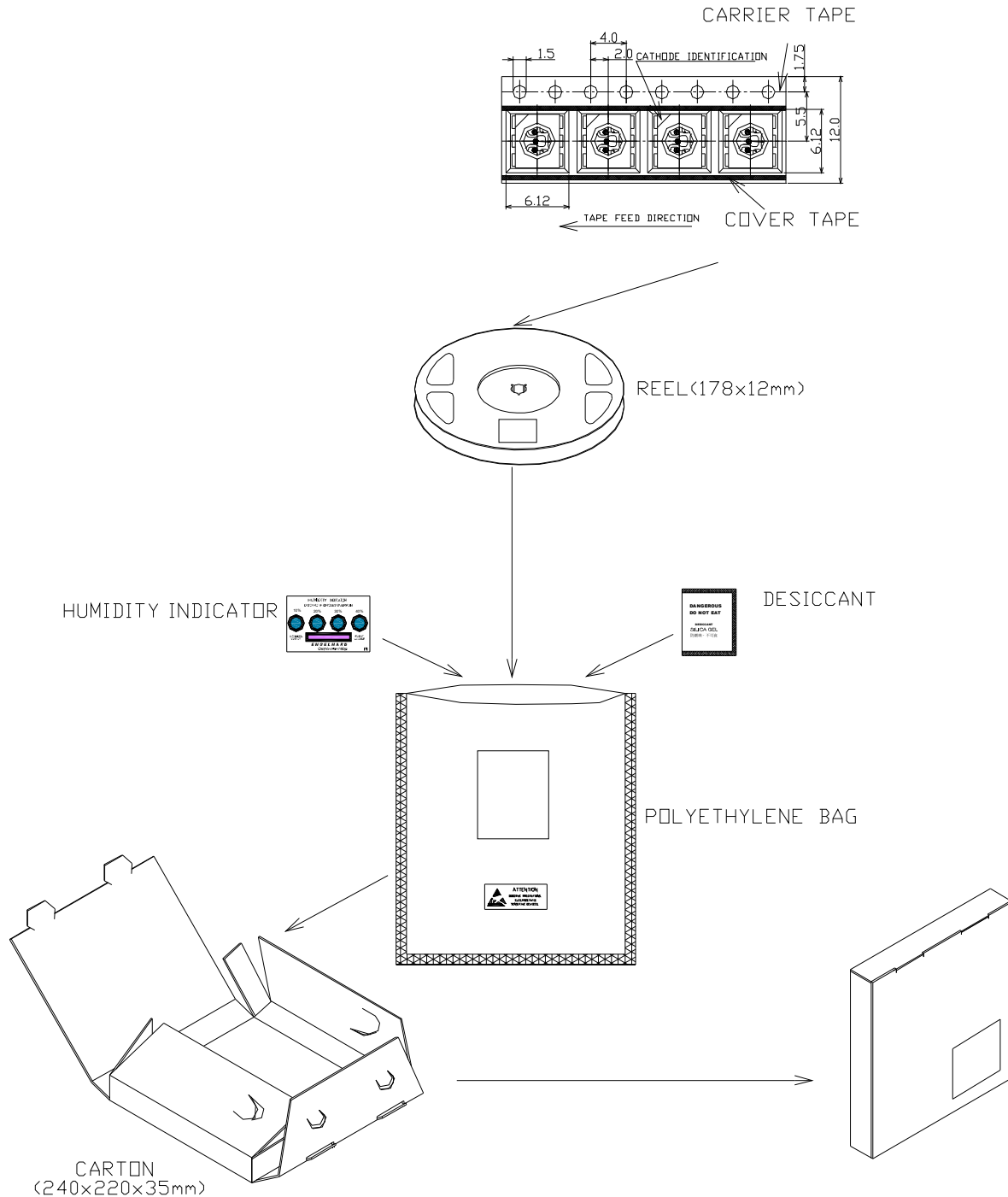

Компания «Океан Электроники» предлагает заключение долгосрочных отношений при поставках импортных электронных компонентов на взаимовыгодных условиях!

Наши преимущества:

- Поставка оригинальных импортных электронных компонентов напрямую с производств Америки, Европы и Азии, а так же с крупнейших складов мира;
- Широкая линейка поставок активных и пассивных импортных электронных компонентов (более 30 млн. наименований);
- Поставка сложных, дефицитных, либо снятых с производства позиций;
- Оперативные сроки поставки под заказ (от 5 рабочих дней);
- Экспресс доставка в любую точку России;
- Помощь Конструкторского Отдела и консультации квалифицированных инженеров;
- Техническая поддержка проекта, помощь в подборе аналогов, поставка прототипов;
- Поставка электронных компонентов под контролем ВП;
- Система менеджмента качества сертифицирована по Международному стандарту ISO 9001;
- При необходимости вся продукция военного и аэрокосмического назначения проходит испытания и сертификацию в лаборатории (по согласованию с заказчиком);
- Поставка специализированных компонентов военного и аэрокосмического уровня качества (Xilinx, Altera, Analog Devices, Intersil, Interpoint, Microsemi, Actel, Aeroflex, Peregrine, VPT, Syfer, Eurofarad, Texas Instruments, MS Kennedy, Miteq, Cobham, E2V, MA-COM, Hittite, Mini-Circuits, General Dynamics и др.);

Компания «Океан Электроники» является официальным дистрибьютором и эксклюзивным представителем в России одного из крупнейших производителей разъемов военного и аэрокосмического назначения «JONHON», а так же официальным дистрибьютором и эксклюзивным представителем в России производителя высокотехнологичных и надежных решений для передачи СВЧ сигналов «FORSTAR».



JONHON

«JONHON» (основан в 1970 г.)

Разъемы специального, военного и аэрокосмического назначения:

(Применяются в военной, авиационной, аэрокосмической, морской, железнодорожной, горно- и нефтедобывающей отраслях промышленности)

«FORSTAR» (основан в 1998 г.)

ВЧ соединители, коаксиальные кабели, кабельные сборки и микроволновые компоненты:

(Применяются в телекоммуникациях гражданского и специального назначения, в средствах связи, РЛС, а так же военной, авиационной и аэрокосмической отраслях промышленности).



Телефон: 8 (812) 309-75-97 (многоканальный)

Факс: 8 (812) 320-03-32

Электронная почта: ocean@oceanchips.ru

Web: <http://oceanchips.ru/>

Адрес: 198099, г. Санкт-Петербург, ул. Калинина, д. 2, корп. 4, лит. А