

## 12mm Rotary Type, Metal Shaft Series

### Application

- ✓ Audio, Home appliance, Automotive, Communication

### Feature

- ✓ Suit for various applications



### ■Specification

Total Rotational Angle	300±5°
Maximum Operating Voltage	100V AC
Insulation Resistance	50MΩ at DC500V
Dielectric Strength	AC 500V for 1 minute
Rotational Torque	RV120DF: 20-150 gf.cm; Others: 10-150 gf.cm
Click Torque	50-300 gf.cm
Rotational Stop Strength of the Shaft	RV120DF: 4 kgf.cm; Others: 3 kgf.cm min
Push/Pull Strength of the Shaft	10kgf for 10 sec
Rotation Life	15,000 cycles

### ■How to order

RV120F – 10 B1 – 15F – A50K – 0C

#### Model

#### Bushing Type

RV120DF-20B1, RV120DF-40B1

Order Code	Length
B1	5 mm

#### Other Model

Order Code	Length
B1	5 mm
Blank	7 mm

#### Metal Shaft Type

#### Click

Model	Order code	Description
RV120DF	1	No click
	1C	With center click
Other	Blank	No click
	0C	With center click

#### Taper and Resistance Value

Order Code	Taper	Resistance Value
A100K	Log/A	100KΩ
B1M	Linear/B	1MΩ
C500K	Rev-log/C	500KΩ

Taper: A, B and C

Resistance Value: 1KΩ to 500KΩ and 1MΩ

\*Contact us for other requirements.

## 12mm Rotary Type, Metal Shaft Series

### ■ Model Description

Model	Number of Unit	Switch Function	Terminal Type	With Sleeve or Bushing	Rotational Angle
<a href="#">RV120F-10</a>	Single unit	N/A	Solder lug	Metal bushing	300°±5°
<a href="#">RV120F-20</a>	Single unit	N/A	Horizontal	Metal bushing	300°±5°
<a href="#">RV120F-21</a>	Single unit	N/A	Horizontal	Metal bushing	300°±5°
<a href="#">RV122F-10</a>	Dual unit	N/A	Solder lug	Metal bushing	300°±5°
<a href="#">RV122F-20</a>	Dual unit	N/A	Horizontal	Metal bushing	300°±5°
<a href="#">RV122F-21</a>	Dual unit	N/A	Horizontal	Metal bushing	300°±5°
<a href="#">RV124F-20</a>	Quad unit	N/A	Horizontal	Metal bushing	300°±5°
<a href="#">RV124F-21</a>	Quad unit	N/A	Horizontal	Metal bushing	300°±5°
<a href="#">RV120DF-20B1</a>	Single unit	N/A	Horizontal	Metal bushing	300°±5°
<a href="#">RV120DF-40B1</a>	Single unit	N/A	Vertical	Metal bushing	300°±5°

Order Code	Outline Drawing
RV120F-10	  <p>SHAFT SHOWN IN FULL C.C.W. POSITION</p>



[Back to top](#)

## 12mm Rotary Type, Metal Shaft Series

Order Code	Outline Drawing
RV120F-20 RV120F-21 	 <p>SHAFT SHOWN IN FULL C.C.W. POSITION</p> <p>P.C.B. MOUNTING HOLE DETAIL</p>
RV122F-10 	 <p>SHAFT SHOWN IN FULL C.C.W. POSITION</p>
RV122F-20 RV122F-21 	 <p>SHAFT SHOWN IN FULL C.C.W. POSITION</p> <p>P.C.B. MOUNTING HOLE DETAIL</p>
RV124F-20 RV124F-21 	 <p>SHAFT SHOWN IN FULL C.C.W. POSITION</p> <p>P.C.B. MOUNTING HOLE DETAIL</p>

[Back to top](#)

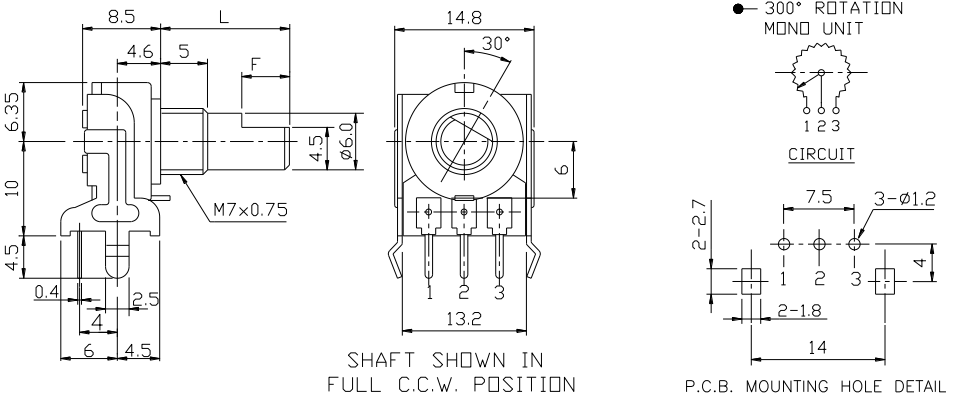
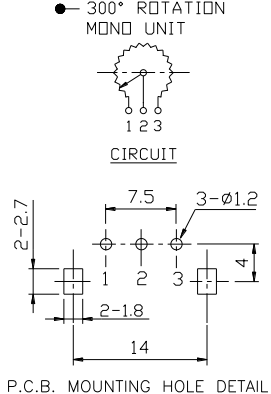
## 12mm Rotary Type, Metal Shaft Series

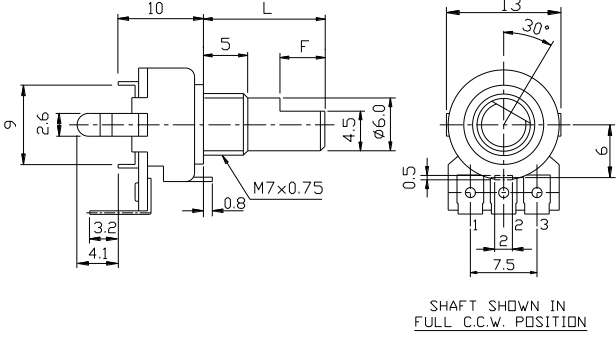
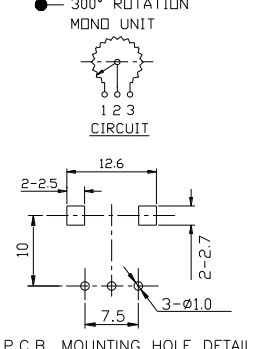
Order Code	Outline Drawing	
<p>RV120DF-20B1</p> 	 <p>SHAFT SHOWN IN FULL C.C.W. POSITION</p>	 <p>P.C.B. MOUNTING HOLE DETAIL</p>
<p>RV120DF-40B1</p> 	 <p>SHAFT SHOWN IN FULL C.C.W. POSITION</p>	 <p>P.C.B. MOUNTING HOLE DETAIL</p>

### ■ Metal Shaft Type

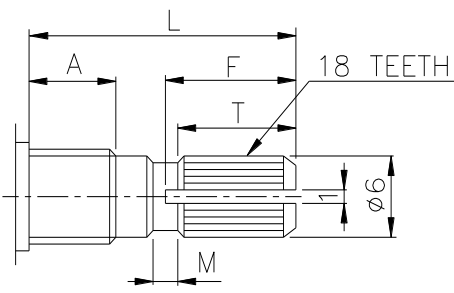
K Type	RV120DF-20B1 RV120DF-40B1	RV120F Other Models																																								
	<p>A : 5mm</p>	<p>A : 7mm</p>																																								
	<table border="1"> <thead> <tr> <th>Order Code</th> <th>L</th> <th>T</th> <th>F</th> <th>M</th> </tr> </thead> <tbody> <tr> <td>15K</td> <td>15</td> <td>6</td> <td>6.5</td> <td>1</td> </tr> <tr> <td>20K</td> <td>20</td> <td>10</td> <td>11</td> <td>2</td> </tr> <tr> <td>25K</td> <td>25</td> <td>12</td> <td>14</td> <td>4</td> </tr> </tbody> </table>	Order Code	L	T	F	M	15K	15	6	6.5	1	20K	20	10	11	2	25K	25	12	14	4	<table border="1"> <thead> <tr> <th>Order Code</th> <th>L</th> <th>T</th> <th>F</th> <th>M</th> </tr> </thead> <tbody> <tr> <td>15K</td> <td>15</td> <td>6</td> <td>6.5</td> <td>1</td> </tr> <tr> <td>20K</td> <td>20</td> <td>10</td> <td>11</td> <td>2</td> </tr> <tr> <td>25K</td> <td>25</td> <td>12</td> <td>14</td> <td>4</td> </tr> </tbody> </table>	Order Code	L	T	F	M	15K	15	6	6.5	1	20K	20	10	11	2	25K	25	12	14	4
Order Code	L	T	F	M																																						
15K	15	6	6.5	1																																						
20K	20	10	11	2																																						
25K	25	12	14	4																																						
Order Code	L	T	F	M																																						
15K	15	6	6.5	1																																						
20K	20	10	11	2																																						
25K	25	12	14	4																																						

[Back to top](#)

## 12mm Rotary Type, Metal Shaft Series

### ■ Metal Shaft Type

<b>F Type</b> 	RV120DF-20B1 RV120DF-40B1	RV120F Other Models																								
<b>R Type</b> 	A : 5mm & 7mm  <table border="1" data-bbox="909 1003 1157 1205"> <thead> <tr> <th>Order Code</th> <th>L</th> </tr> </thead> <tbody> <tr> <td>15R</td> <td>15</td> </tr> <tr> <td>20R</td> <td>20</td> </tr> <tr> <td>25R</td> <td>25</td> </tr> </tbody> </table>		Order Code	L	15R	15	20R	20	25R	25																
Order Code	L																									
15R	15																									
20R	20																									
25R	25																									
A : 5mm  <table border="1" data-bbox="635 548 954 750"> <thead> <tr> <th>Order Code</th> <th>L</th> <th>F</th> </tr> </thead> <tbody> <tr> <td>15F</td> <td>15</td> <td>7</td> </tr> <tr> <td>20F</td> <td>20</td> <td>12</td> </tr> <tr> <td>25F</td> <td>25</td> <td>14</td> </tr> </tbody> </table>	Order Code	L	F	15F	15	7	20F	20	12	25F	25	14	A : 7mm  <table border="1" data-bbox="1114 548 1433 750"> <thead> <tr> <th>Order Code</th> <th>L</th> <th>F</th> </tr> </thead> <tbody> <tr> <td>15F</td> <td>15</td> <td>7</td> </tr> <tr> <td>20F</td> <td>20</td> <td>12</td> </tr> <tr> <td>25F</td> <td>25</td> <td>14</td> </tr> </tbody> </table>		Order Code	L	F	15F	15	7	20F	20	12	25F	25	14
Order Code	L	F																								
15F	15	7																								
20F	20	12																								
25F	25	14																								
Order Code	L	F																								
15F	15	7																								
20F	20	12																								
25F	25	14																								

Design and specifications presented here are for the standard parts only. Please kindly contact us for your special requests and ask for the current technical specifications before purchase and/or use.

[Back to top](#)

# Mouser Electronics

Authorized Distributor

Click to View Pricing, Inventory, Delivery & Lifecycle Information:

## Alpha (Taiwan):

[RV120F-10-15F-B10K](#) [RV120F-20-15F-B10K](#) [RV120F-20-15F-A10K](#) [RV120F-10-15F-A10K](#) [RV120F-10-15F-B100K](#)  
[RV120F-20-15F-B100K](#) [RV120F-20-15F-A100K](#) [RV120F-10-15F-A100K](#) [RV120F-10-15F-A50K](#) [RV120F-20-15F-A50K](#) [RV120F-10-15F-B50K](#) [RV120F-20-15F-B50K](#) [RV120F-10-15F-A1M](#) [RV120F-10-15F-A1K](#) [RV120F-10-15F-A5K](#) [RV120F-20-15F-A1M](#) [RV120F-10-15F-B5K](#) [RV120F-10-15F-B1K](#) [RV120F-10-15F-B1M](#) [RV120F-10-15F-A500K](#)  
[RV120F-20-15F-A500K](#) [RV120F-10-15F-B500K](#) [RV120F-20-15F-B500K](#) [RV120F-20-15F-B5K](#) [RV120F-20-15F-B1M](#) [RV120F-20-15F-B1K](#) [RV120F-20-15F-A1K](#) [RV120F-20-15F-A5K](#) [RV120F-20-15K-A20K](#) [RV120F-20-15R-B50K](#)  
[RV120F-10-15F-A10K-0075](#) [RV120F-20-15F-B100K-0075](#) [RV120F-10-15F-A5K-0075](#) [RV120F-10-15F-B1K-0075](#) [RV120F-20-15F-A5K-0075](#) [RV120F-20-15F-B5K-0075](#) [RV120F-20-15F-A1M-0075](#) [RV120F-10-15F-A50K-0075](#) [RV120F-10-15F-B5K-0075](#) [RV120F-20-15F-B500K-0075](#) [RV120F-20-15F-B1M-0075](#) [RV120F-10-15F-B1M-0075](#) [RV120F-20-15F-A1K-0075](#) [RV120F-20-15K-A20K-0075](#) [RV120F-10-15F-B10K-0075](#) [RV120F-20-15F-B1K-0075](#) [RV120F-10-15F-A1M-0075](#) [RV120F-10-15F-B100K-0075](#) [RV120F-20-15F-A100K-0075](#) [RV120F-20-15F-A50K-0075](#) [RV120F-20-15F-B50K-0075](#) [RV120F-20-15F-A500K-0075](#) [RV120F-10-15F-A1K-0075](#) [RV120F-10-15F-A500K-0075](#) [RV120F-10-15F-B500K-0075](#) [RV120F-10-15F-B50K-0075](#) [RV120F-10-15F-A100K-0075](#) [RV120F-20-15F-A10K-0075](#) [RV120F-20-15F-B10K-0075](#) [RV120F-20-15R-B50K-0075](#)

Компания «Океан Электроники» предлагает заключение долгосрочных отношений при поставках импортных электронных компонентов на взаимовыгодных условиях!

Наши преимущества:

- Поставка оригинальных импортных электронных компонентов напрямую с производств Америки, Европы и Азии, а так же с крупнейших складов мира;
- Широкая линейка поставок активных и пассивных импортных электронных компонентов (более 30 млн. наименований);
- Поставка сложных, дефицитных, либо снятых с производства позиций;
- Оперативные сроки поставки под заказ (от 5 рабочих дней);
- Экспресс доставка в любую точку России;
- Помощь Конструкторского Отдела и консультации квалифицированных инженеров;
- Техническая поддержка проекта, помощь в подборе аналогов, поставка прототипов;
- Поставка электронных компонентов под контролем ВП;
- Система менеджмента качества сертифицирована по Международному стандарту ISO 9001;
- При необходимости вся продукция военного и аэрокосмического назначения проходит испытания и сертификацию в лаборатории (по согласованию с заказчиком);
- Поставка специализированных компонентов военного и аэрокосмического уровня качества (Xilinx, Altera, Analog Devices, Intersil, Interpoint, Microsemi, Actel, Aeroflex, Peregrine, VPT, Syfer, Eurofarad, Texas Instruments, MS Kennedy, Miteq, Cobham, E2V, MA-COM, Hittite, Mini-Circuits, General Dynamics и др.);

Компания «Океан Электроники» является официальным дистрибьютором и эксклюзивным представителем в России одного из крупнейших производителей разъемов военного и аэрокосмического назначения «JONHON», а так же официальным дистрибьютором и эксклюзивным представителем в России производителя высокотехнологичных и надежных решений для передачи СВЧ сигналов «FORSTAR».



## JONHON

«JONHON» (основан в 1970 г.)

Разъемы специального, военного и аэрокосмического назначения:

(Применяются в военной, авиационной, аэрокосмической, морской, железнодорожной, горно- и нефтедобывающей отраслях промышленности)

«FORSTAR» (основан в 1998 г.)

ВЧ соединители, коаксиальные кабели, кабельные сборки и микроволновые компоненты:

(Применяются в телекоммуникациях гражданского и специального назначения, в средствах связи, РЛС, а так же военной, авиационной и аэрокосмической отраслях промышленности).



Телефон: 8 (812) 309-75-97 (многоканальный)

Факс: 8 (812) 320-03-32

Электронная почта: [ocean@oceanchips.ru](mailto:ocean@oceanchips.ru)

Web: <http://oceanchips.ru/>

Адрес: 198099, г. Санкт-Петербург, ул. Калинина, д. 2, корп. 4, лит. А