

---

## 1.2 A, 30 V Step-Down DC/DC Converter

---

NO.EA-269-160225

### OUTLINE

The R1245x is a CMOS-based Step-down DC/DC converter with internal N-channel high side Tr. The ON resistance of the built-in high-side transistor is 0.35  $\Omega$  and the R1245x can provide the maximum 1.2 A output current. Each of the ICs consists of an oscillator, a PWM control circuit, a voltage reference unit, an error amplifier, a phase compensation circuit, a slope compensation circuit, a soft-start circuit, protection circuits, an internal voltage regulator, and a switch for bootstrap circuit. The ICs can make up a step-down DC/DC converter with an inductor, resistors, a diode, and capacitors.

The R1245x is a current mode operating type DC/DC converter without an external current sense resistor, and realizes fast response and high efficiency. As an output capacitor, a ceramic type capacitor can be used with the R1245x. The options of the internal oscillator frequency are preset at 330 kHz for version A and B, 500 kHz for version C and D, 1000 kHz for version E and F, 2400 kHz for version G and H.

As for protection, an Lx peak current limit circuit cycle by cycle, a thermal shutdown function and an under voltage lockout (UVLO) function are built in. Furthermore, there are two types for short protection, for A/C/E/G version, a latch protection function which makes the output latch off if the output voltage keeps lower than the set output voltage for a certain time after detecting current limit is built in, for B/D/F/H version, a fold-back protection function which changes the oscillator frequency slower after detecting short circuit or equivalent.

As for the packages of the R1245x, HSOP-8E, DFN(PLP)2020-8, SOT23-6W are available.

### FEATURES

- Operating Voltage ..... 4.5 V to 30 V
- Internal N-channel MOSFET Driver ..... Typ.  $R_{ON} = 0.35 \Omega$
- Adjustable Output Voltage with External Resistor .... 0.8 V or more
- Feedback Voltage and Tolerance ..... 0.8 V $\pm$ 1.0%
- Peak Current Limit..... Typ. 2.0 A
- UVLO Function Released Voltage..... Typ. 4.0 V
- Operating Frequency ..... 330 kHz (Ver. A/B), 500 kHz (Ver. C/D),  
1000 kHz (Ver. E/F), 2400 kHz (Ver. G/H)
- Fold-back Protected Frequency..... 170 kHz (Ver. B/D), 250 kHz (Ver. F), 400 kHz (Ver. H)
- Latch Protection Delay Time ..... Typ. 4 ms (Ver. A/C/E/G)
- Ceramic Capacitors Recommended for Input and Output.
- Stand-by Current..... Typ. 0  $\mu$ A
- Packages ..... SOT-23-6W, DFN(PLP)2020-8, HSOP-8E

# R1245x

NO.EA-269-160225

## APPLICATIONS

- Digital Home Appliances: Digital TVs, DVD Players
- Office Equipment: Printers, Faxes
- 5V PSU or 2-cell or more Li-ion Battery Powered Communication Equipment, Cameras, VCRs, Camcorders
- High Voltage Battery-powered Equipment

## BLOCK DIAGRAM

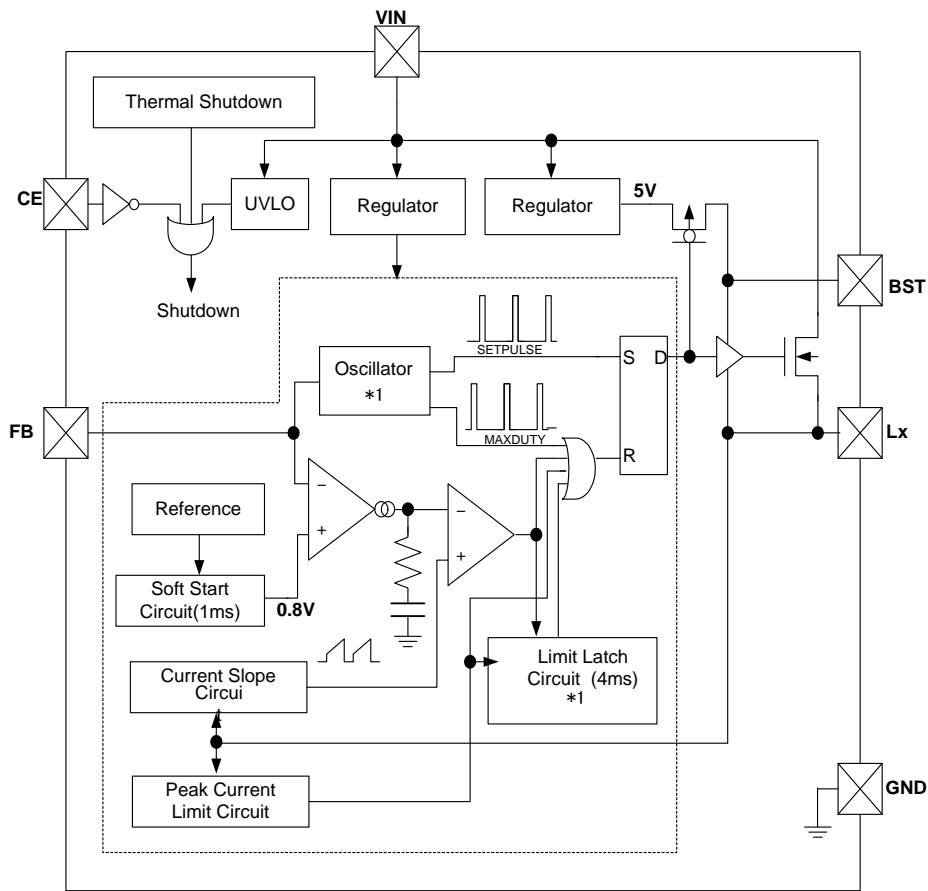

R1245x Block Diagram

\*1

Version	Oscillator Frequency	Short Protection Type
A	330 kHz	330 kHz
B	330 kHz	330 kHz
C	500 kHz	500 kHz
D	500 kHz	500 kHz
E	1000 kHz	1000 kHz
F	1000 kHz	1000 kHz
G	2400 kHz	2400 kHz
H	2400 kHz	2400 kHz

## SELECTION GUIDE

In the R1245x, the package, type of short protection (Latch or Fold-back), and the oscillator frequency can be selected with the user's request.

### Selection Guide

Product code	Package	Quantity per Reel	Pb Free	Halogen Free
R1245S003*-E2-FE	HSOP-8E	1,000 pcs	Yes	Yes
R1245K003*-TR	DFN(PLP)2020-8	5,000 pcs	Yes	Yes
R1245N001*-TR-FE	SOT-23-6W	3,000 pcs	Yes	Yes

\*: Designation of the oscillator frequency and the protection function option.

Symbol	Oscillator Frequency	Latch Protection	Fold-back Protection
A	330 kHz	✓	
B	330 kHz		✓
C	500 kHz	✓	
D	500 kHz		✓
E	1000 kHz	✓	
F	1000 kHz		✓
G	2400 kHz	✓	
H	2400 kHz		✓

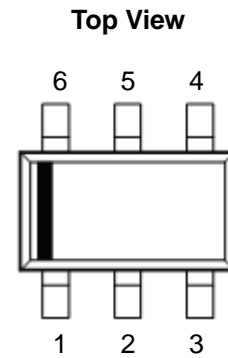
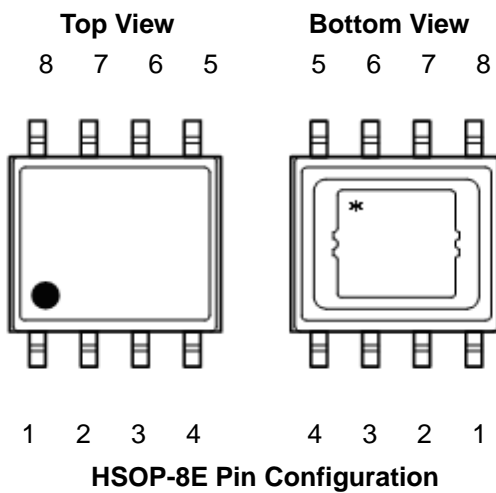
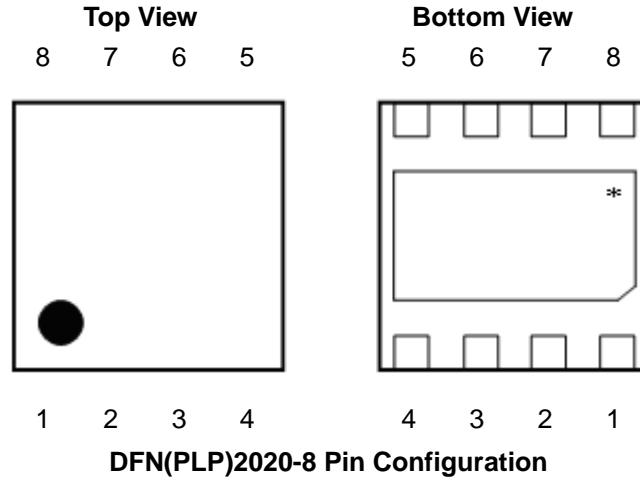
**PIN DESCRIPTIONS****SOT-23-6W Pin Configuration**

\* Connect the backside heat radiation tub to GND or same as GND level (recommendation). The tub is connected to the GND pin.

**R1245S Pin Description**

Pin No.	Symbol	Description
1	Lx	Lx Switching Pin
2	VIN	Power Supply Pin
3	CE	Chip Enable Pin, Active with "H"
4	TEST	TEST pin (must be open for user side.)
5	GND	Ground Pin
6	FB	Feedback Pin
7	NC	No connection
8	BST	Bootstrap Pin

\* Connect the backside heat radiation tub to GND or same as GND level (recommendation). The tub is connected to the GND pin.

**R1245K Pin Description**

Pin No.	Symbol	Description
1	Lx	Lx Switching Pin
2	VIN	Power Supply Pin
3	VIN	Power Supply Pin
4	CE	Chip Enable Pin, Active with "H"
5	GND	Ground Pin
6	FB	Feedback Pin
7	TEST	Test Pin (must be open for user side.)
8	BST	Bootstrap Pin

\* Connect the backside heat radiation tub to GND or same as GND level (recommendation). The tub is connected to the GND pin.

**R1245N Pin Description**

Pin No.	Symbol	Description
1	BST	Bootstrap Pin
2	GND	Ground Pin
3	FB	Feedback Pin
4	CE	Chip Enable Pin, Active with "H"
5	VIN	Power Supply Pin
6	Lx	Lx Switching Pin

**ABSOLUTE MAXIMUM RATINGS****Absolute Maximum Ratings**

(GND = 0 V)

Symbol	Item	Rating		Unit
$V_{IN}$	Input Voltage	-0.3 V to 32 V		V
$V_{BST}$	BST Pin Voltage	$V_{LX} - 0.3 \text{ V}$ to $V_{LX} + 6 \text{ V}$		V
$V_{LX}$	Lx Pin Voltage	-0.3 V to $V_{IN} + 0.3$		V
$V_{CE}$	CE Pin Input Voltage	-0.3 V to $V_{IN} + 0.3$		V
$V_{FB}$	CE Pin Input Voltage	-0.3 V to 6 V		V
$P_D$	Feedback Pin Voltage	-0.3 V to 32 V		V
$T_a$	Power Dissipation (Standard Land Pattern)*	HSOP-8E	2900	mW
		DFN(PLP)2020-8	880	
		SOT-23-6W	430	
$T_{stg}$	Operating Temperature Range	-40 to 105		°C
$V_{IN}$	Storage Temperature Range	-55 to 125		°C

\* For Power Dissipation, refer to the PACKAGE INFORMATION on the web site.

**ABSOLUTE MAXIMUM RATINGS**

Electronic and mechanical stress momentarily exceeded absolute maximum ratings may cause the permanent damages and may degrade the lifetime and safety for both device and system using the device in the field. The functional operation at or over these absolute maximum ratings is not assured.

**RECOMMENDED OPERATING CONDITIONS (ELECTRICAL CHARACTERISTICS)**

All of electronic equipment should be designed that the mounted semiconductor devices operate within the recommended operating conditions. The semiconductor devices cannot operate normally over the recommended operating conditions, even if when they are used over such conditions by momentary electronic noise or surge. And the semiconductor devices may receive serious damage when they continue to operate over the recommended operating conditions.

## ELECTRICAL CHARACTERISTICS

## Electrical Characteristics

(Unless otherwise noted,  $V_{IN} = 12\text{ V}$ ,  $T_a = 25^\circ\text{C}$ )

Symbol	Item	Conditions	Min.	Typ.	Max.	Unit
$V_{IN}$	Operating Input Voltage		4.5		30	V
$I_{IN}$	Consumption Current	$V_{IN} = 30\text{ V}$ , $V_{FB} = 1.0\text{ V}$		0.5	1.0	mA
$V_{UVLO1}$	UVLO Detect Voltage	Specified $V_{IN}$ falling edge	3.6	$V_{UVLO2}$ -0.2	$V_{UVLO2}$ -0.1	V
$V_{UVLO2}$	UVLO Released Voltage	Specified rising edge	3.8	4.0	4.2	V
$V_{FB}$	VFB Voltage Tolerance		0.792	0.800	0.808	V
$\Delta V_{FB}/\Delta T_a$	VFB Voltage Temperature Coefficient	$-40^\circ\text{C} \leq T_a \leq 105^\circ\text{C}$		$\pm 100$		ppm/ °C
fosc	Oscillator Frequency	Ver. A/B	300	330	360	kHz
		Ver. C/D	450	500	550	
		Ver. E/F	900	1000	1100	
		Ver. G/H	2200	2400	2600	
f <sub>FLB</sub>	Fold back Frequency	$V_{FB} < 0.56\text{ V}$	Ver. B/D		170	kHz
			Ver. F		250	
			Ver. H		400	
Maxduty	Oscillator Maximum Duty Cycle	Ver. A/B/C/D	92			%
		Ver. E/F	88			
		Ver. G/H	76			
	Soft-start Time	$V_{FB} = 0.72\text{ V}$		1		ms
	Delay Time for Latch Protection	Ver. A/C/E/G		4		ms
t <sub>start</sub>	Lx High Side Switch ON Resistance	$V_{BST} - V_{LX} = 4.5\text{ V}$		0.35		Ω
t <sub>DLY</sub>	Lx High Side Switch Leakage Current	$V_{IN} = 30\text{ V}$ , $V_{CE} = 0\text{ V}$		0	5	μA
R <sub>LXH</sub>	Lx High Side Switch Limited Current	$V_{BST} - V_{LX} = 4.5\text{ V}$	1.5	2.0	2.7	A
I <sub>LXHOFF</sub>	CE "L" Input Voltage	$V_{IN} = 30\text{ V}$			0.3	V
I <sub>LIMLXH</sub>	CE "H" Input Voltage	$V_{IN} = 30\text{ V}$	1.6			V
V <sub>CEH</sub>	VFB Input Current	$V_{IN} = 30.0\text{ V}$ , $V_{FB} = 1.0\text{ V}$	-1.0		1.0	μA
V <sub>CEL</sub>	CE "L" Input Current	$V_{IN} = 30\text{ V}$ , $V_{CE} = 0\text{ V}$	-1.0		1.0	μA
I <sub>FB</sub>	CE "H" Input Current	$V_{IN} = 30\text{ V}$ , $V_{CE} = 30\text{ V}$	-1.0		1.0	μA
I <sub>CEH</sub>	Thermal Shutdown Detect Temperature	Hysteresis 30°C		160		°C
I <sub>CEL</sub>	Standby Current	$V_{IN} = 30\text{ V}$		0	5	μA

TYPICAL APPLICATION

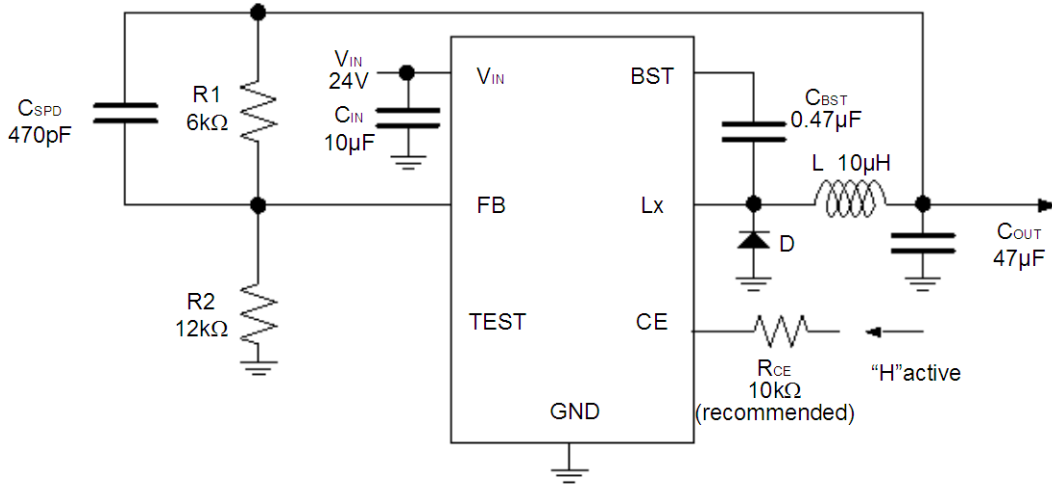

R1245x00xA/B Typical Application, 330 kHz,  $V_{OUT} = 1.2\text{ V}$ ,  $V_{IN} = 24\text{ V}$

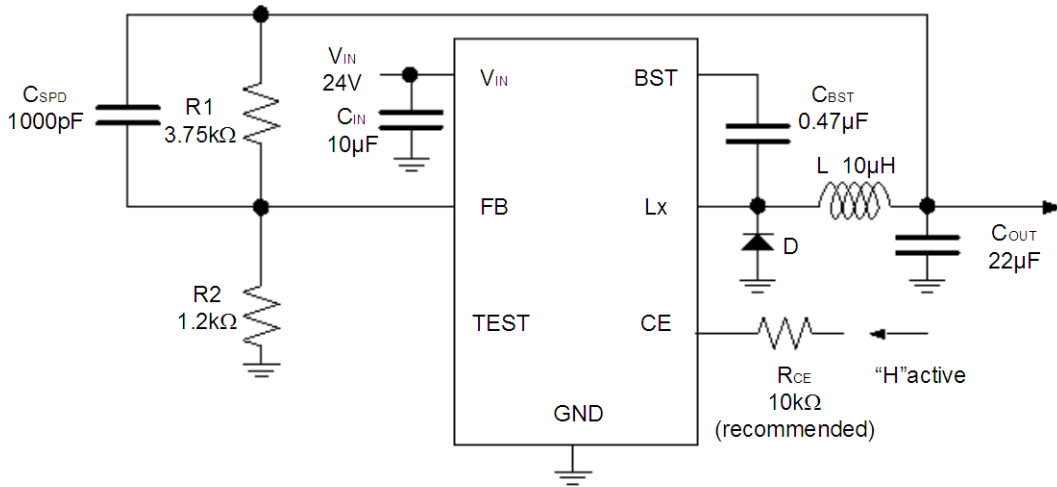

R1245x00xC/D Typical Application, 500 kHz,  $V_{OUT} = 3.3\text{ V}$ ,  $V_{IN} = 24\text{ V}$

\* TEST pin must be open.



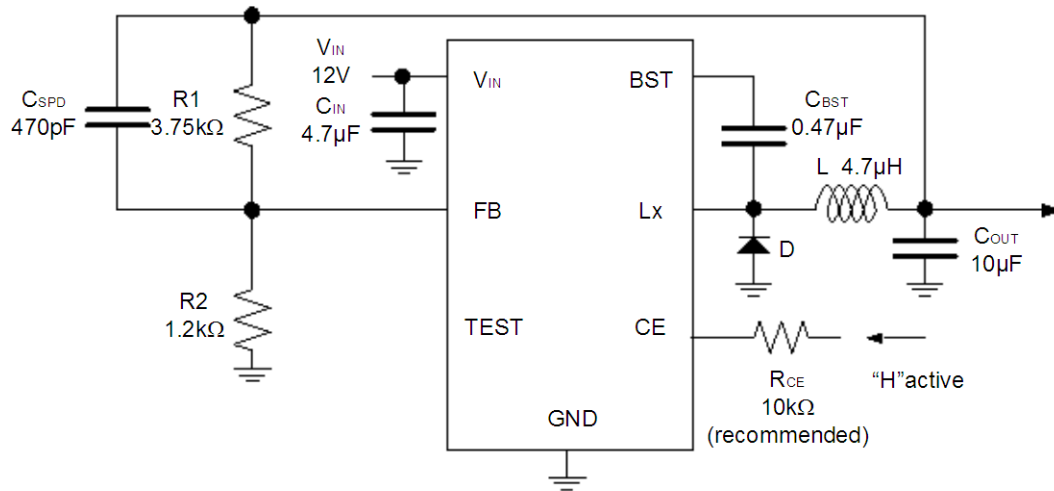

R1245x00xE/F Typical Application, 1000 kHz,  $V_{OUT} = 3.3\text{ V}$ ,  $V_{IN} = 12\text{ V}$

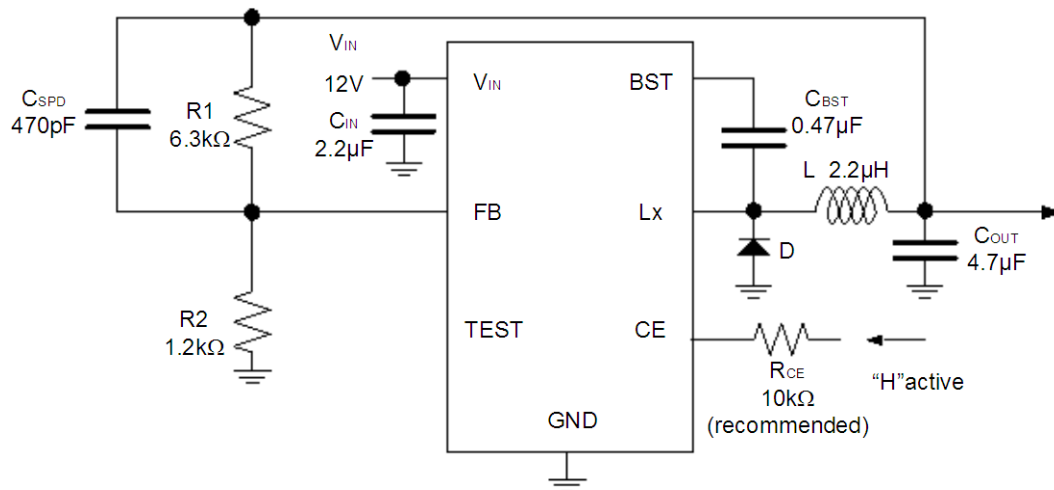

R1245x00xG/H Typical Application, 2400 kHz,  $V_{OUT} = 5.0\text{ V}$ ,  $V_{IN} = 12\text{ V}$

\* TEST pin must be open.

## TECHNICAL NOTES

- External components must be connected as close as possible to the ICs and make wiring as short as possible. Especially, the capacitor connected in between VIN pin and GND pin must be wiring the shortest. If their impedance is high, internal voltage of the IC may shift by the switching current, and the operating may be unstable. Make the power supply and GND lines sufficient. In the wiring of the power supply, GND, LX, VOUT and the inductor, large current by switching may flow. To avoid the bad influence, the wiring between the resistance, “R<sub>UP</sub>” for setting the output voltage and loading, and the wiring between the inductor and loading must be separated.
- The ceramic capacitors have low ESR (Equivalent Series Resistance) and recommended for the ICs. The recommendation of CIN capacitor between VIN and GND is 10 μF or more for A/B/C/D version, 4.7 μF or more for E/F version, and 2.2 μF or more for G/H version. Verify the bias dependence and the temperature characteristics of the ceramic capacitors. Recommendation conditions are written based on the case which the recommendation parts are used with the R1245x.
- The R1245x is designed with the recommendation inductance value and ceramic capacitor value and phase compensation has been made. If the inductance value is large, due to the lack of current sensing amount of the current mode, unstable operation may result. On the contrary, if the inductance value is small, the current sensing amount may increase too much, low frequency oscillation may occur when the on duty ratio is beyond 50%. Not only that, if the inductance value is small, according to the increase of the load current, the peak current of the switching may increase, as a result, the current may reach the current limit value and the current limit may work.
- As for the diode, use the Schottky diode with small capacitance between terminals. The reference characteristic of the capacitance between terminals is around 100 pF or less at 10 V. If the capacitance between terminals is large, excess switching current may flow and the operation of the IC may be unstable. If the capacitance between terminals of the Scottky diode is beyond 100 pF at 10 V or unknown, verify the load regulation, line regulation, and the load transient response.
- Output voltage can be set by adjustment of the values of R1 and R2. The equation of setting the output voltage is  $V_{OUT} = V_{FB} \times (R1 + R2) / R2$ . If the values of R1 and R2 are large, the impedance of FB pin increases, and pickup the noise may result. The recommendation value range of R2 is approximately between 1.0 kΩ to 16 kΩ. If the operation may be unstable, reduce the impedance of FB pin.
- For the CE pin, as an ESD protection element, a diode to VIN pin is formed internal of the IC. If CE pin voltage may become higher than VIN pin voltage, to prevent flowing large current from CE pin to VIN pin, connect 10 kΩ or more resistor between CE and VIN pin.
- Connect the backside heat radiation tub of the DFN(PLP)2020-9/HSOP-8E to the GND. As for multi-layered boards, to make better power dissipation, putting some thermal via on the thermal pad in the land pattern and radiation of the heat to another layer is effective.
- After the soft-start operation, the latch function is enabled for version A/C/E/G. The latch protection starts the internal counter when the internal current limit protection circuit detects the current limit. When the internal counter counts up to the latch timer limit, typically 4 ms, the output is latched off. To reset the latch function, make the CE pin “L”, or make VIN pin voltage lower than UVLO detector threshold. Then in the case that the output voltage or FB voltage becomes setting voltage within the latch timer preset time, counter is initialized. If the slew rate of the power supply is too slow and after the soft-start time, the output voltage does not reach the set output voltage even if the latch timer preset time is over, the latch function may work unexpectedly.

- After the soft-start operation, fold-back protection function is enabled for version B/D/F/H. The fold-back function will limit the oscillator frequency if the FB pin voltage becomes lower than typically 0.56 V. For B/D version, the oscillator frequency will be reduced typically into 170 kHz, for F version, into 250 kHz, for H version, into 400 kHz.
- If the slew rate of the power supply is too slow, and even after the soft-start time, the output voltage is still less than 70% of the set output voltage, or FB pin voltage is less than typically 0.56 V, then this function may work unexpectedly.
- The performance of power circuit using this IC largely depends on external components. Selection of external components is very important, especially, do not exceed each rating value (voltage/current/power).

**Table 1. Recommended Values for Each Output Voltage**

R1245x00xA/B: 330 kHz

V <sub>OUT</sub> (V)	0.8 to 1.2	1.2 to 2.5	2.5 to 5.0	5.0 ≤
R1 (R <sub>UP</sub> ) (kΩ)	= (V <sub>OUT</sub> / 0.8 - 1) × R2			
R2 (R <sub>BOT</sub> ) (kΩ)	16	12	1.20	1.20
C <sub>SPD</sub> (pF)	open	470	2200	1000
C <sub>OUT</sub> (μF)	47	47	22	22
L (μH)	4.7	10	15	33

R1245x00xC/D: 500 kHz

V <sub>OUT</sub> (V)	0.8 to 1.2	1.2 to 1.5	1.5 to 2.0	2.0 to 5.0	5.0 to 12.0	12.0 ≤
R1 (R <sub>UP</sub> ) (kΩ)	= (V <sub>OUT</sub> / 0.8 - 1) × R2					
R2 (R <sub>BOT</sub> ) (kΩ)	16	16	16	1.2	1.2	1.2
C <sub>SPD</sub> (pF)	open	100	100	1000	1000	470
C <sub>OUT</sub> (μF)	100	100	22	22	22	22
L (μH)	4.7	4.7	10	10	15	15

R1245x00xE/F: 1000 kHz

V <sub>OUT</sub> (V)	0.8 to 1.0	1.0 to 1.2	1.2 to 1.5	1.5 to 2.5	2.5 to 5.0	5.0 ≤
R1 (R <sub>UP</sub> ) (kΩ)	= (V <sub>OUT</sub> / 0.8 - 1) × R2					
R2 (R <sub>BOT</sub> ) (kΩ)	16	16	16	16	1.2	1.2
C <sub>SPD</sub> (pF)	open	100	100	100	470	470
C <sub>OUT</sub> (μF)	100	100	47	22	10	10
L (μH)	2.2	2.2	2.2	2.2	4.7	10

R1245x00xG/H: 2400 kHz

V <sub>OUT</sub> (V)	1.2 to 1.8	1.8 to 2.5	2.5 to 5.0	5.0 ≤
R1 (R <sub>UP</sub> ) (kΩ)	= (V <sub>OUT</sub> / 0.8 - 1) × R2			
R2 (R <sub>BOT</sub> ) (kΩ)	16	12	1.2	1.2
C <sub>SPD</sub> (pF)	100	100	470	470
C <sub>OUT</sub> (μF)	10	10	4.7	4.7
L (μH)	1.0	1.5	2.2	4.7

**\*1 Divider Resistors Values and Possible Setting Range of Input/ Output**

V <sub>OUT</sub> [V]	R1 (R <sub>UP</sub> ) [kΩ]	R2 (R <sub>BOT</sub> ) [kΩ]	Input Voltage Range [V]			
			Ver. A/B	Ver. C/D	Ver. E/F	Ver. G/H
0.8	0	open	4.5 to 20	4.5 to 13.5	4.5 to 7	-
	0	16				
1	4	16	4.5 to 25.5	4.5 to 17	4.5 to 8.5	-
1.2	8	16	4.5 to 30	4.5 to 20	4.5 to 10	-
	6	12				
1.5	10.5	12	4.5 to 30	4.5 to 25	4.5 to 12.5	4.5 to 5.5
	14	16				
1.8	20	16	4.5 to 30	4.5 to 30	4.5 to 15	4.5 to 6.5
	15	12				
2	24	16	4.5 to 30	4.5 to 30	4.5 to 17	4.5 to 7
	1.8	1.2				
2.5	34	16	4.5 to 30	4.5 to 30	4.5 to 21	4.5 to 9
	25.5	12				
	2.55	1.2				
3.3	3.75	1.2	4.5 to 30	4.5 to 30	4.5 to 27.5	4.5 to 12
5	6.3	1.2	5.5 to 30	5.5 to 30	6 to 30	7 to 17
6	7.8	1.2	6.5 to 30	6.5 to 30	7 to 30	8 to 20
9	12.3	1.2	10 to 30	10 to 30	11 to 30	12 to 30
12	16.8	1.2	13 to 30	13 to 30	14 to 30	16 to 30
15	21.3	1.2	16.5 to 30	16.5 to 30	17 to 30	20 to 30
24	34.8	1.2	26.5 to 30	26.5 to 30	27.5 to 30	30

Table 2. Recommended External Components Examples (Considering All the Range)

Symbol	Condition	Value	Parts Name	MFR
C <sub>IN</sub>	50 V/ X5R	10 $\mu$ F	UMK325BJ106MM-P	TAIYO YUDEN
	50 V/ X5R	10 $\mu$ F	CGA6P3X7S1H106K	TDK
	50 V/ X7R	4.7 $\mu$ F	GRM31CR71H475KA12L	Murata
	50 V/ X7R	2.2 $\mu$ F	GRM31CR71H225KA88L	Murata
C <sub>OUT</sub>	50 V/ X5R	10 $\mu$ F	UMK325BJ106MM-P	TAIYO YUDEN
	50 V/ X5R	10 $\mu$ F	CGA6P3X7S1H106K	TDK
	50 V/ X7R	10 $\mu$ F	KTS500B106M55N0T00	Nippon Chemi-Con
	25 V/ X7R	10 $\mu$ F	GRM31CR71E106K	Murata
	10 V/ X7R	22 $\mu$ F	GRM31CR71A226M	Murata
	16 V/ B	47 $\mu$ F	GRM32EB31C476KE15	Murata
	10 V/ X7R	47 $\mu$ F	GRM32ER71A476KE15	Murata
			NOTE: The value of C <sub>OUT</sub> depends on the setting output voltage.	
C <sub>BST</sub>	16 V/ X7R	0.47 $\mu$ F	EMK212B7474KD-T	TAIYO YUDEN
L	1.8 A	10 $\mu$ H	SLF6045T-100M1R6-3PF	TDK
	1.65 A	4.7 $\mu$ H	SLF7045T-4R7M2R0-PF	TDK
	1.7 A	4.7 $\mu$ H	NR4018T-4R7M2R0-PF	TDK
	2.4 A	4.7 $\mu$ H	NR6020T4R7N	TAIYO YUDEN
	1.9 A	10 $\mu$ H	NR6028T100M	TAIYO YUDEN
	2.3 A	15 $\mu$ H	NR6045T150M	TAIYO YUDEN
	1.9 A	22 $\mu$ H	NR6045T220M	TAIYO YUDEN
	1.9 A	33 $\mu$ H	NR8040T330M	TAIYO YUDEN
	1.7 A	2.2 $\mu$ H	VLCF4020T-2R2N1R7	TDK
	1.65 A	2.2 $\mu$ H	NR4012T2R2M	TAIYO YUDEN
	1.8 A	1.5 $\mu$ H	NR3015T1R5N	TAIYO YUDEN
	1.8 A	1.0 $\mu$ H	NR4010T1R0N	TAIYO YUDEN
D	30 V/ 1.5 A	0.42 V	MA22D28	Panasonic
	30 V/ 2.0 A	0.37 V	CMS06	TOSHIBA
	40 V/ 2.0 A	0.55 V	CMS11	TOSHIBA
	40 V/ 2.0 A	0.43 V	MA24D60	Panasonic
	15 V/ 2.0 A	0.32 V	SBS010M	SANYO
R <sub>CE</sub>	An up diode is formed between the CE pin and the VIN pin as an ESD protection element. If the CE pin may become higher than the voltage of the VIN pin, connect the 10 k $\Omega$ resistance between the CE pin and VIN pin, to prevent a large current from flowing into the VIN pin from the CE pin.			

## OPERATION OF THE BUCK CONVERTER AND THE OUTPUT CURRENT

The DC/DC converter charges energy in the inductor when the switch turns on, and discharges the energy from the inductor when the switch turns off and controls with less energy loss, so that a lower output voltage than the input voltage is obtained. Refer to the following figures.

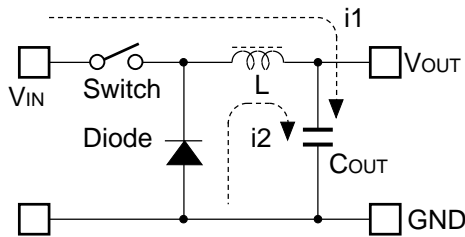

**Basic Circuit**

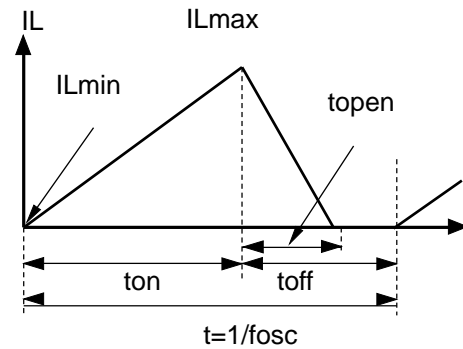

**Current flowing through the Inductor**

Step 1: The switch turns on and current  $I_L (= i_1)$  flows, and energy is charged into  $C_{OUT}$ . At this moment,  $I_L$  increases from  $I_{Lmin} (= 0)$  to reach  $I_{Lmax}$  in proportion to the on-time period ( $t_{on}$ ) of the switch.

Step 2: When the switch turns off, the diode turns on in order to maintain  $I_L$  at  $I_{Lmax}$ , and current  $I_L (= i_2)$  flows.

Step 3:  $I_L (= i_2)$  decreases gradually and reaches  $I_L = I_{Lmin} = 0$  after a time period of  $t_{open}$ , and the diode turns off. This case is called as discontinuous mode. If the output current becomes large, next switching cycle starts before  $I_L$  becomes 0 and the diode turns off. In this case,  $I_L$  value increases from  $I_{Lmin} (> 0)$ , and this case is called continuous mode.

In the case of PWM control system, the output voltage is maintained by controlling the on-time period ( $t_{on}$ ), with the oscillator frequency ( $f_{osc}$ ) being maintained constant.

## OUTPUT CURRENT AND SELECTION OF EXTERNAL COMPONENTS

The relation between the output current and external components is as follows:

When the switch of Lx turns on:

(Wherein, the peak to peak value of the ripple current is described as  $I_{RP}$ , the ON resistance of the switch is described as  $R_{ONH}$ , and the diode forward voltage as  $V_F$ , and the DC resistance of the inductor is described as  $R_L$ , and on time of the switch is described as  $t_{on}$ )

$$V_{IN} = V_{OUT} + (R_{ONH} + R_L) \times I_{OUT} + L \times I_{RP} / t_{on} \dots\dots\dots \text{Equation 1}$$

When the switch turns off (the diode turns on) as toff:

$$L \times I_{RP} / t_{off} = V_F + V_{OUT} + R_L \times I_{OUT} \dots\dots\dots \text{Equation 2}$$

Put Equation 2 to Equation 1 and solve for ON duty of the switch,  $t_{on} / (t_{off} + t_{on}) = D_{ON}$ ,

$$D_{ON} = (V_{OUT} + V_F + R_L \times I_{OUT}) / (V_{IN} + V_F - R_{ONH} \times I_{OUT}) \dots\dots\dots \text{Equation 3}$$

Ripple Current is as follows:

$$I_{RP} = (V_{IN} - V_{OUT} - R_{ONH} \times I_{OUT} - R_L \times I_{OUT}) \times D_{ON} / f_{osc} / L \dots\dots\dots \text{Equation 4}$$

wherein, peak current that flows through L, and the peak current  $I_{Lmax}$  is as follows:

$$I_{Lmax} = I_{OUT} + I_{RP} / 2 \dots\dots\dots \text{Equation 5}$$

As for the valley current  $I_{Lmin}$ ,

$$I_{Lmin} = I_{OUT} - I_{RP} / 2 \dots\dots\dots \text{Equation 6}$$

If  $I_{Lmin} < 0$ , the step-down DC/DC converter operation becomes current discontinuous mode.

Therefore the current condition of the current discontinuous mode, the next formula is true.

$$I_{OUT} < I_{RP} / 2 \dots\dots\dots \text{Equation 7}$$

Consider  $I_{Lmax}$  and  $I_{Lmin}$ , conditions of input and output and select external components.

\*The above explanation is based on the calculation in an ideal case in continuous mode.

**Ripple Current and Lx Current Limit**

The ripple current of the inductor may change according to the various reasons. In the R1245x, as an Lx current limit, Lx peak current limit is used. Therefore the upper limit of the inductor current is fixed.

The peak current limit is not the average current of the inductor (output current). If the ripple current is large, peak current becomes also large. The characteristic is used for the fold-back current limit of version B/D/F/H. In other words, the peak current limit is maintained and the switching frequency is reduced, as a result, the average current of the inductor is reduced. To release this condition, at 170 kHz for version B/D, at 250 kHz for version F, at 400 kHz for version H must not be beyond the peak current limit. In the fig.1, the sequence of the Lx current limit function is described.

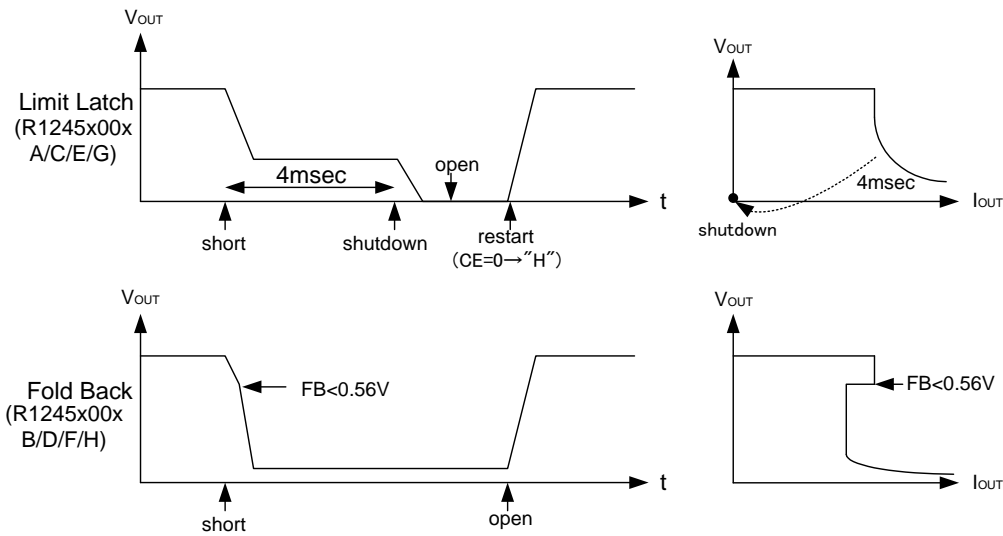

**Fig.1 Lx Limit function sequence**

**Latch Protection Function for Version A/C/E/G**

The latch function works after detecting current limit and if the output voltage becomes low for a certain time, the output is latched off. Refer to the TECHNICAL NOTES.

**Fold-back Protection Function for Version B/D/F/H**

If FB voltage becomes lower than approximately 0.56 V, the fold-back protection function limits the oscillator frequency to typically 170 kHz for version B/D, typically 250 kHz fir version F, typically 400 kHz for version H. By reducing frequency, the ripple current increases. The R1245x has the peak current limit function, therefore as in the equation 8, the Lx average current decreases by the increase of the ripple current.

$$I_{OUT} = I_{Lmax} + I_{RP} / 2 \dots \dots \dots \text{Equation 8}$$

If FB voltage becomes less than 0.56 V, the oscillator frequency is reduced. At heavy load, if the R1245x becomes into the fold-back protection mode, the situation may not be released by increase the ripple current. In terms of other notes on this protection function, refer to the TECHNICAL NOTES.



## MAXIMUM OUTPUT CURRENT

The output current of the R1245x is limited by the power dissipation  $P_D$  of the package and the maximum specification 1.2 A. The loss of the IC includes the switching loss, and it is difficult to estimate. To estimate the maximum output, using the efficiency data is one method.

By using the efficiency data, the loss including the external components can be calculated with the equation,  $(100 / \text{efficiency} (\%) - 1) \times (V_{OUT} (V) \times I_{OUT} (A))$ . From this equation, by reducing the loss of external components, the loss of the IC can be estimated. The main loss of the external components is composed by the rectifier diode and DCR of the inductor. Supposed that the forward voltage of the diode is described as  $V_F$ , the loss of the diode can be described as follows:

$$(V_{IN} (V) - R_{ON} (\Omega) \times I_{OUT} (A) - V_{OUT} (V) - V_F (V)) / V_{IN} (V) \times V_F (V) \times I_{OUT} (A)$$

The loss by the DCR of the inductor can be calculated by the formula  $DCR (\Omega) \times I_{OUT}^2 (A)$ .

Thus,

$$\text{The loss of the IC} = (100 / \text{efficiency} (\%) - 1) \times (V_{OUT} (V) \times I_{OUT} (A) - (V_{IN} (V) - R_{ON} (\Omega) \times I_{OUT} (A) - V_{OUT} (V) - V_F (V)) / V_{IN} (V) \times V_F (V) \times I_{OUT} (A) - DCR (\Omega) \times I_{OUT}^2 (A))$$

The efficiency of the R1245x at  $T_a = 25^\circ\text{C}$ ,  $V_{IN} = 12 \text{ V}$ ,  $V_{OUT} = 3.3 \text{ V}$ ,  $I_{OUT} = 600 \text{ mA}$  is approximately 89.5% for version A/B (Oscillator frequency: 330 kHz). Supposed that the On resistance of the internal driver is  $0.35 \Omega$ , the DCR of the inductor is  $65 \text{ m}\Omega$ , the  $V_F$  of the rectifier diode is  $0.3 \text{ V}$  and applied to the formula above,

$$\text{The loss of the IC} = (100\% / 89.5\% - 1) \times (3.3 \text{ V} \times 0.6 \text{ A}) - (12 \text{ V} - 0.35 \Omega \times 0.6 \text{ A} - 3.3 \text{ V} - 0.3 \text{ V}) / 12 \text{ V} \times 0.3 \text{ V} \times 0.6 \text{ A} - 0.065 \Omega \times 0.6^2 \text{ A} = 86 \text{ mW}$$

The power dissipation  $P_D$  of the package is specified at  $T_a = 25^\circ\text{C}$  based on the  $T_{jmax} = 125^\circ\text{C}$ . Thus the thermal resistance of the package  $\theta_{ja} = (T_{jmax} (^\circ\text{C}) - T_a (^\circ\text{C})) / P_D (W)$ , therefore the thermal resistance of the each available package is as follows:

$$\text{HSOP-8E: } (125^\circ\text{C} - 25^\circ\text{C}) / 2.9 \text{ W} = 34.5^\circ\text{C/W}$$

$$\text{DFN(PLP)2020-8: } (125^\circ\text{C} - 25^\circ\text{C}) / 0.88 \text{ W} = 114^\circ\text{C/W}$$

$$\text{SOT-23-6W: } (125^\circ\text{C} - 25^\circ\text{C}) / 0.43 \text{ W} = 233^\circ\text{C/W}$$

Due to the loss of the IC is 86mW for this example, therefore  $T_j$  increase of the each package is as follows:

$$\text{HSOP-8E: } 34.5^\circ\text{C/W} \times 86 \text{ mW} = 2.96^\circ\text{C}$$

$$\text{DFN(PLP)2020-8: } 114^\circ\text{C/W} \times 86 \text{ mW} = 9.80^\circ\text{C}$$

$$\text{SOT-23-6W: } 233^\circ\text{C/W} \times 86 \text{ mW} = 20.0^\circ\text{C}$$

For all the packages, even if the ambient temperature is at  $105^\circ\text{C}$ ,  $T_j$  can be suppressed less than  $125^\circ\text{C}$ . By the increase of the temperature, on resistance and switching loss increases, therefore, temperature margin is not enough, measure the efficiency at the actual maximum temperature and recalculation is necessary.

At the same condition, if the preset frequency is 2400 kHz, the efficiency will be down to approximately 81%. The result of the loss calculation is 310 mW, therefore the  $T_j$  increase of each package is,

$$\text{HSOP-8E: } 34.5^\circ\text{C/W} \times 310 \text{ mW} = 11^\circ\text{C}$$

$$\text{DFN(PLP)2020-8: } 114^\circ\text{C/W} \times 310 \text{ mW} = 35^\circ\text{C}$$

$$\text{SOT-23-6W: } 233^\circ\text{C/W} \times 310 \text{ mW} = 72^\circ\text{C}$$

---

## R1245x

---

NO.EA-269-160225

HSOP-8E can be used at the ambient temperature 105°C, DFN(PLP)2020-8 can be used at the ambient temperature up to 90°C, SOT-23-6W can be used at the ambient temperature up to 53°C. Note that the result is different by the frequency.

The next graphs are the output current and estimated ambient temperature limit.

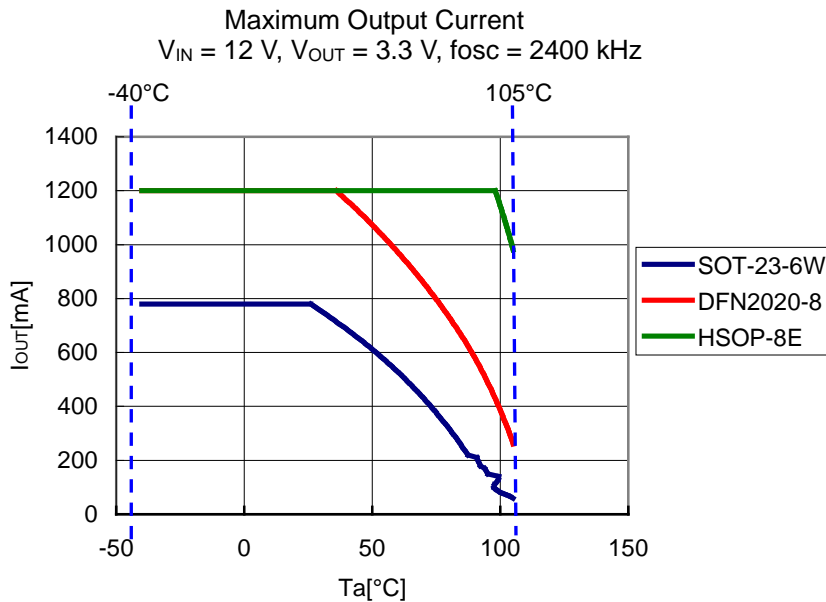
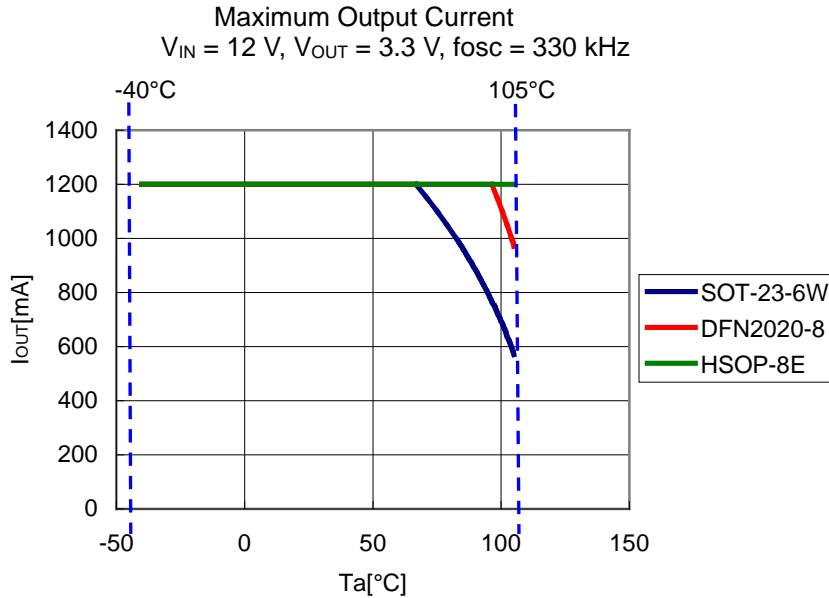

## INTERNAL EQUIVALENT CIRCUIT FOR EACH PIN

&lt;BST pin&gt;

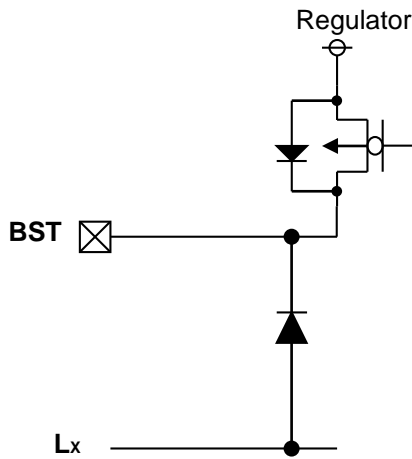

&lt;Lx pin&gt;

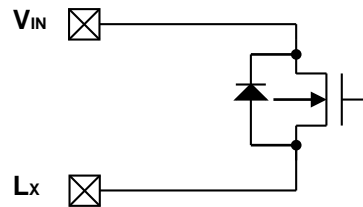

&lt;FB pin&gt;

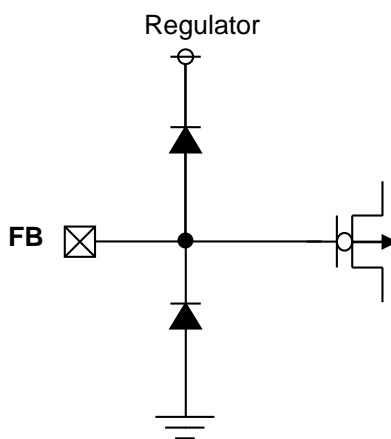

&lt;CE pin&gt;

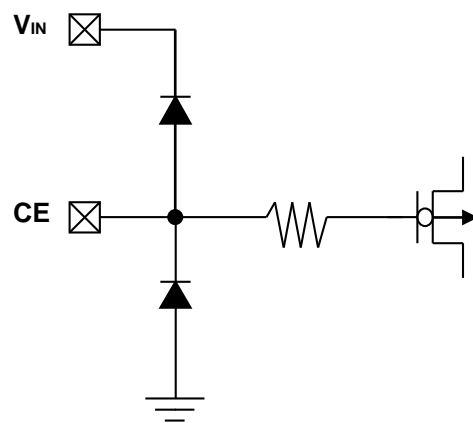

&lt;TEST pin&gt;

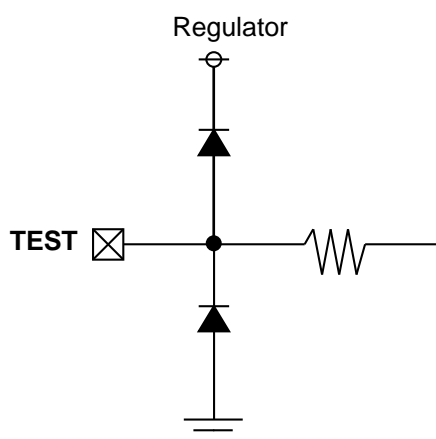

### TYPICAL CHARACTERISTICS

#### 1) FB voltage vs. Temperature

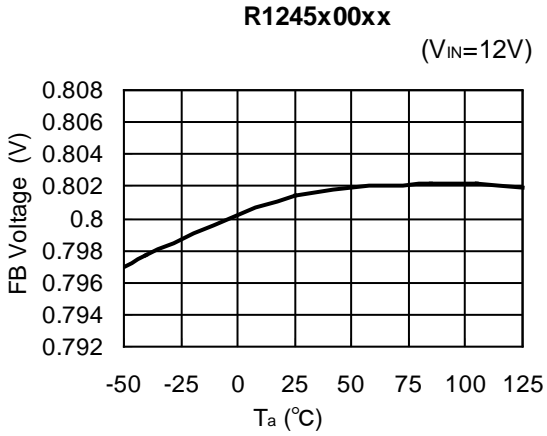

#### 2) Driver On resistance vs. Temperature

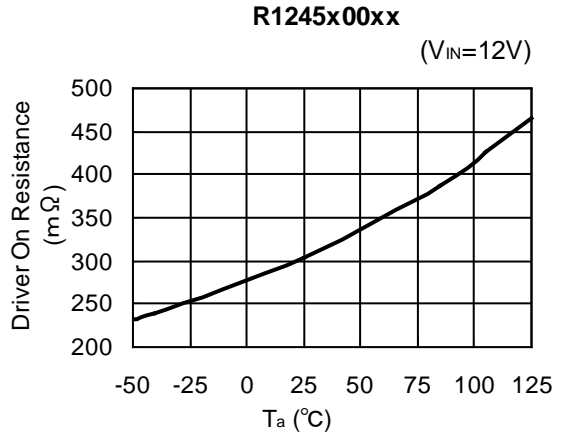

#### 3) Oscillator frequency vs. Temperature

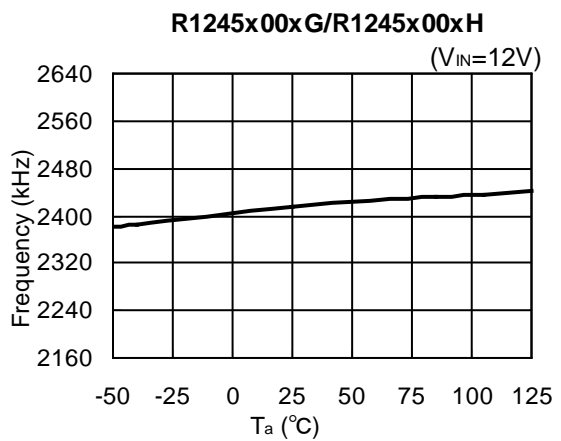
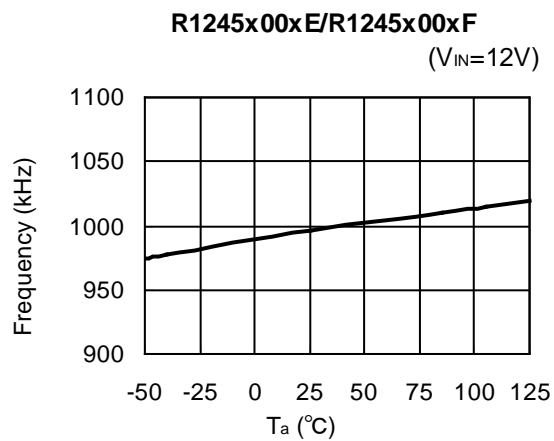
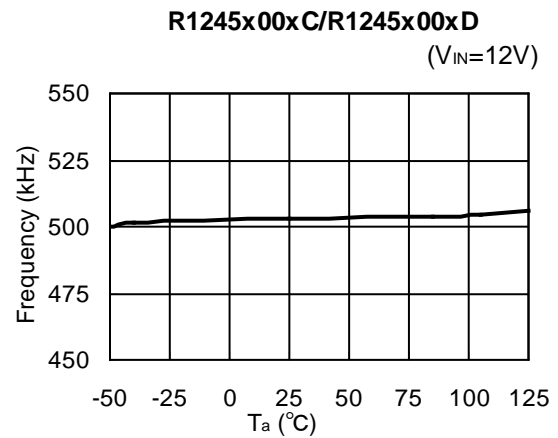
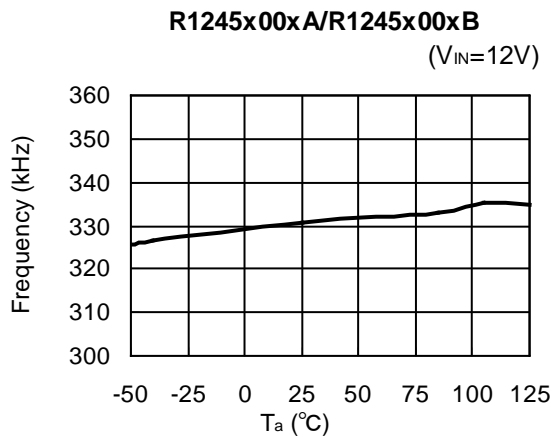

4) Maximum duty cycle vs. Temperature

R1245x00xA/R1245x00xB  
(V<sub>IN</sub>=12V)

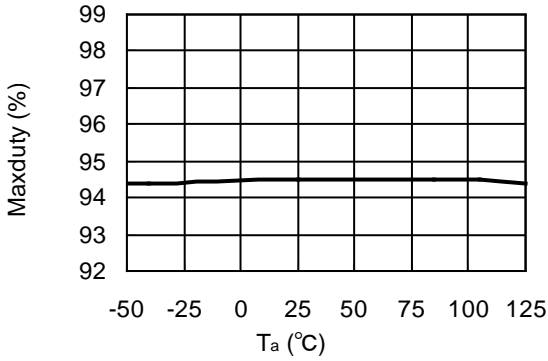

R1245x00xC/R1245x00xD  
(V<sub>IN</sub>=12V)

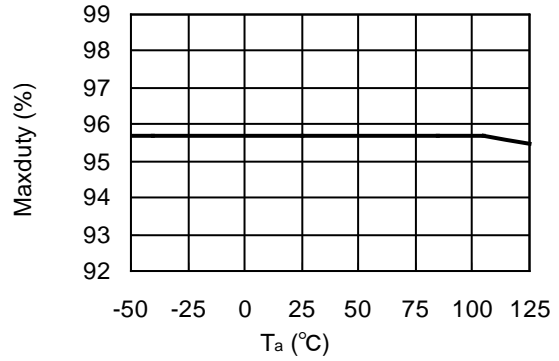

R1245x00xE/R1245x00xF  
(V<sub>IN</sub>=12V)

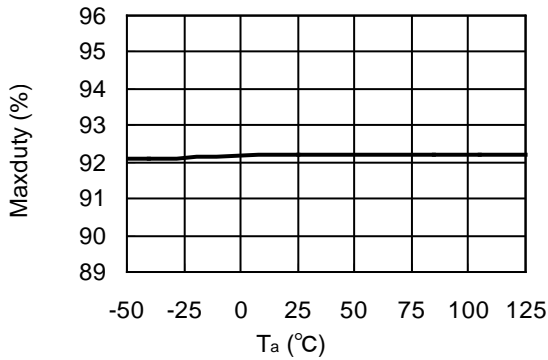

R1245x00xG/R1245x00xH  
(V<sub>IN</sub>=12V)

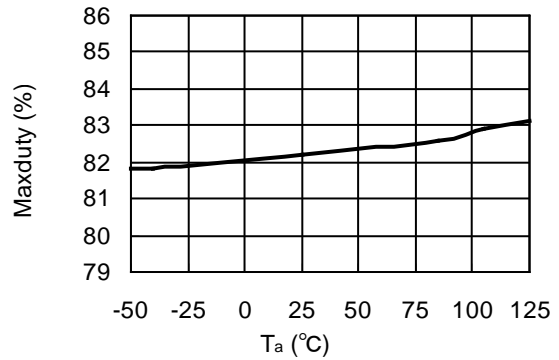

5) Fold back frequency vs. Temperature

R1245x00xB  
(V<sub>IN</sub>=12V)

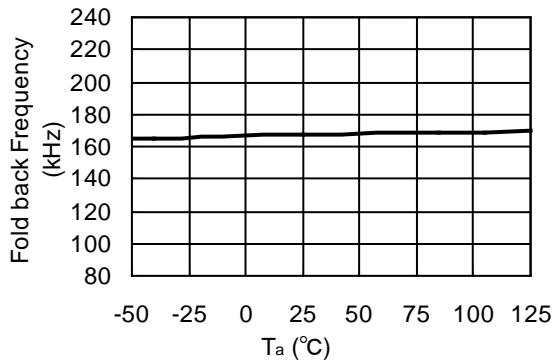

R1245x00xD  
(V<sub>IN</sub>=12V)

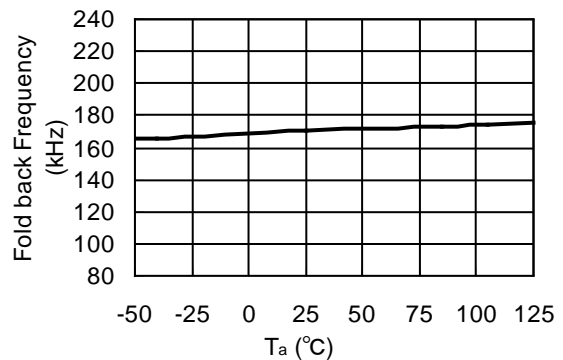

R1245x00xF

(V<sub>IN</sub>=12V)

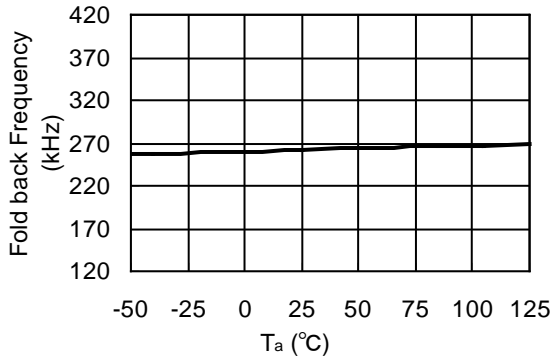

R1245x00xH

(V<sub>IN</sub>=12V)

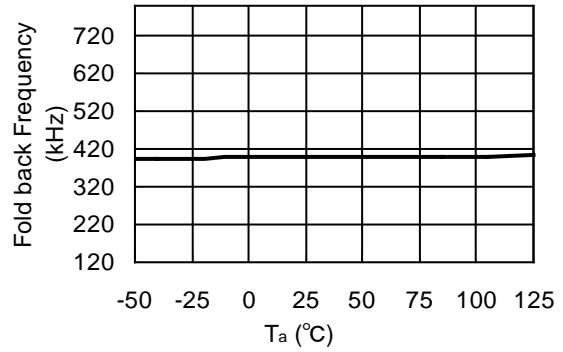

6) High side switch current limit vs. Temperature

R1245x00xx

(V<sub>IN</sub>=12V)

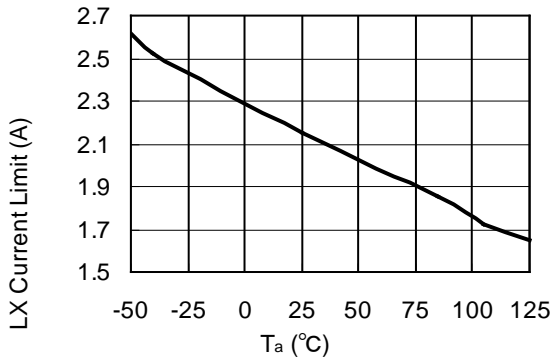

7) UVLO detector threshold vs. Temperature

R1245x00xx

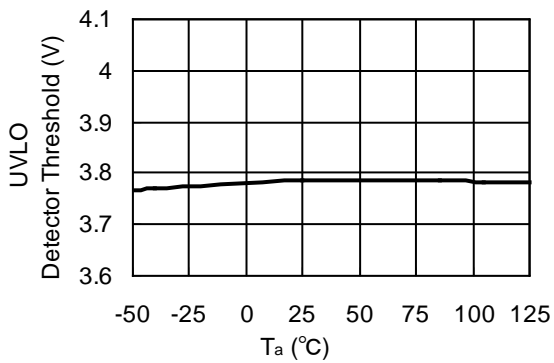

8) UVLO released voltage vs. Temperature

R1245x00xx

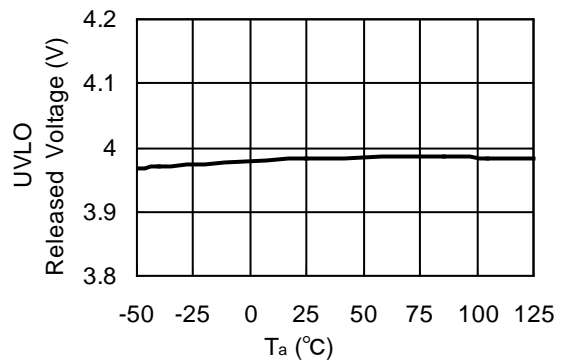

9) Soft-start time vs. Temperature

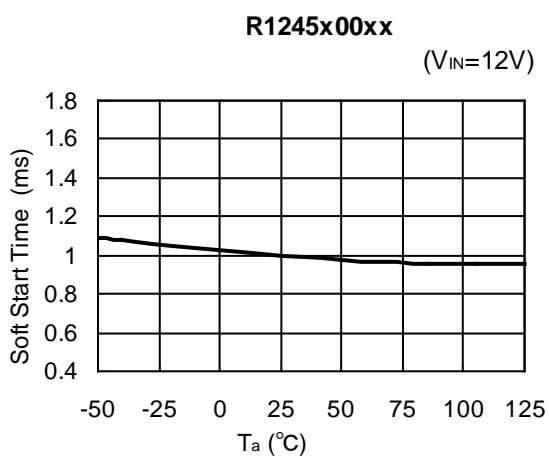

10) Timer latch delay vs. Temperature

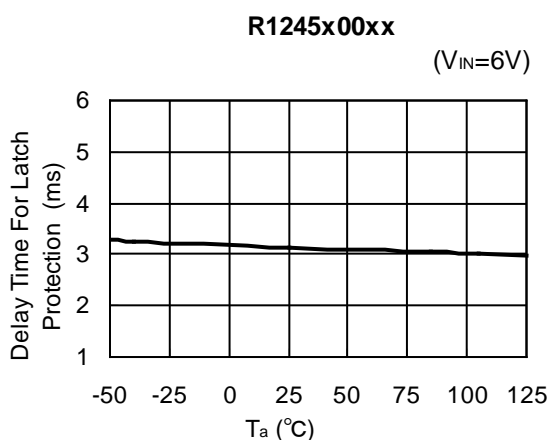

11) CE "H" Input voltage vs. Temperature

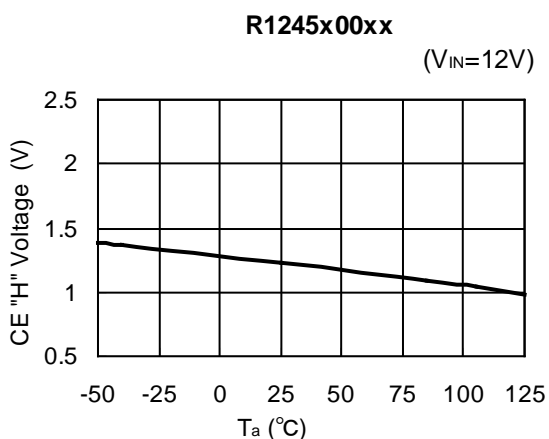

12) CE "L" Input voltage vs. Temperature

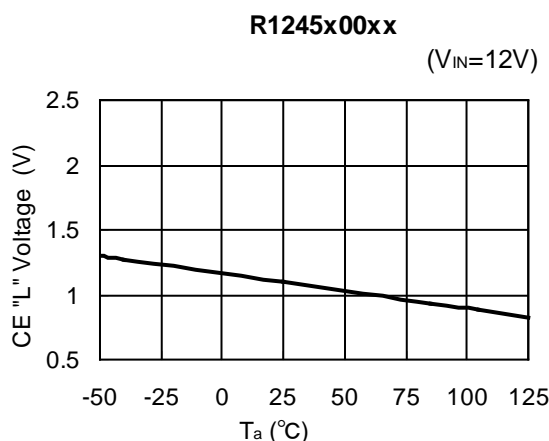

13) Soft-start waveform

R1245x00xA/R1245x00xB  
V<sub>OUT</sub>=3.3V, V<sub>IN</sub>=12V, I<sub>OUT</sub>=0mA, T<sub>a</sub>=25°C

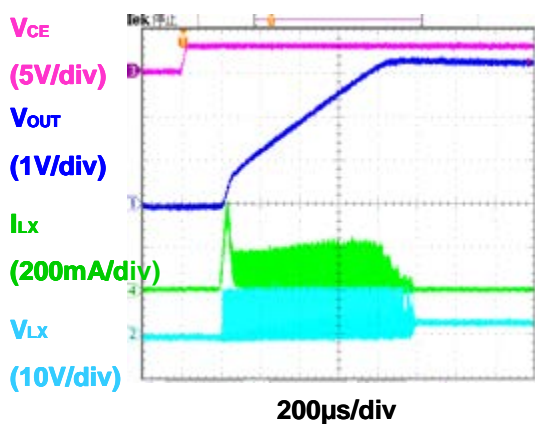

R1245x00xA/R1245x00xB  
V<sub>OUT</sub>=3.3V, V<sub>IN</sub>=12V, I<sub>OUT</sub>=600mA, T<sub>a</sub>=25°C

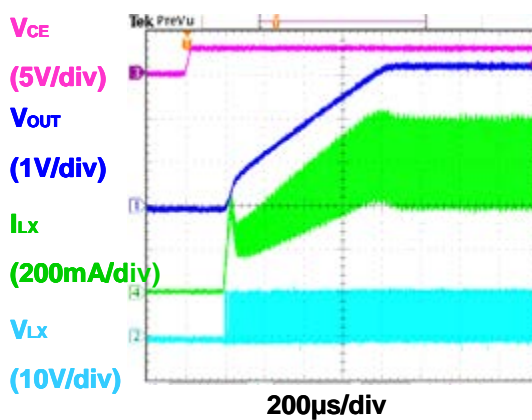

---

# R1245x

---

NO.EA-269-160225

## 14) Switching operation waveform

R1245x00xA/R1245x00xB

$V_{OUT}=3.3V$  ,  $V_{IN}=12V$  ,  $I_{OUT}=0mA$  ,  $T_a=25^\circ C$

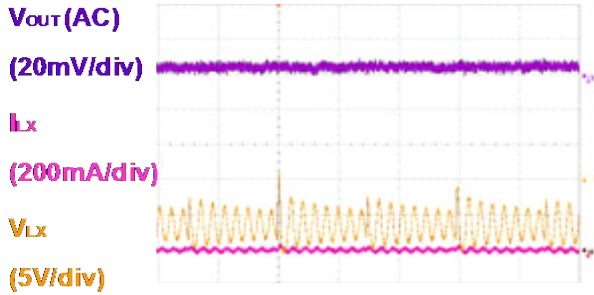

2 $\mu s$ /div

R1245x00xA/R1245x00xB

$V_{OUT}=3.3V$  ,  $V_{IN}=12V$  ,  $I_{OUT}=600mA$  ,  $T_a=25^\circ C$

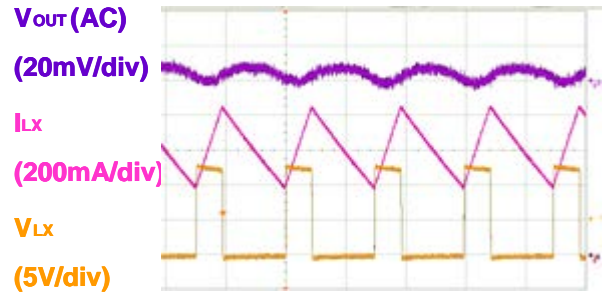

2 $\mu s$ /div

R1245x00xG/R1245x00xH

$V_{OUT}=3.3V$  ,  $V_{IN}=12V$  ,  $I_{OUT}=20mA$  ,  $T_a=25^\circ C$

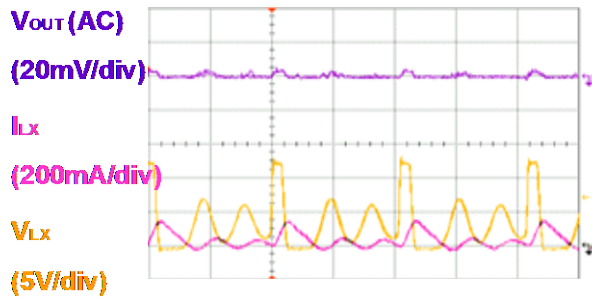

200ns/div

R1245x00xG/R1245x00xH

$V_{OUT}=3.3V$  ,  $V_{IN}=12V$  ,  $I_{OUT}=600mA$  ,  $T_a=25^\circ C$

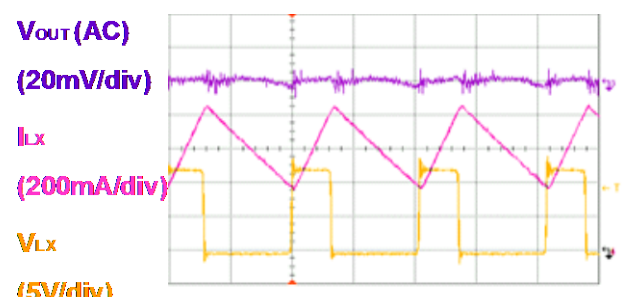

200ns/div

## 15) Load transient response waveform

R1245x00xA/R1245x00xB

$V_{OUT}=0.8V$  ,  $V_{IN}=12V$  ,  $I_{OUT}=600 \leftrightarrow 1200mA$  ,  $T_a=25^\circ C$

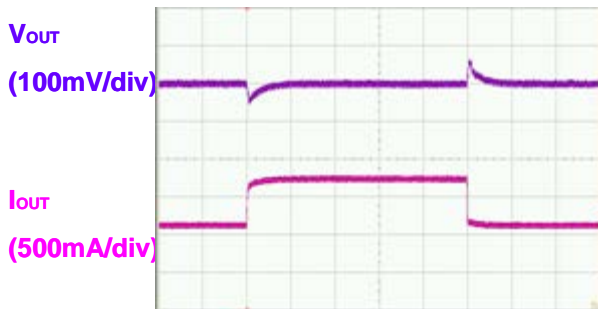

100 $\mu s$ /div

R1245x00XA/R1245x00xB

$V_{OUT}=3.3V$  ,  $V_{IN}=12V$  ,  $I_{OUT}=600 \leftrightarrow 1200mA$  ,  $T_a=25^\circ C$

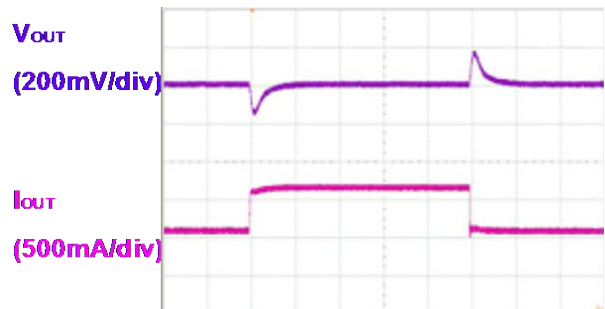

100 $\mu s$ /div



R1245x00xG/R1245x00xH

$V_{OUT}=1.5V$  ,  $V_{IN}=4.5V$  ,  $I_{OUT}=600\leftrightarrow 1200mA$  ,  $T_a=25^\circ C$

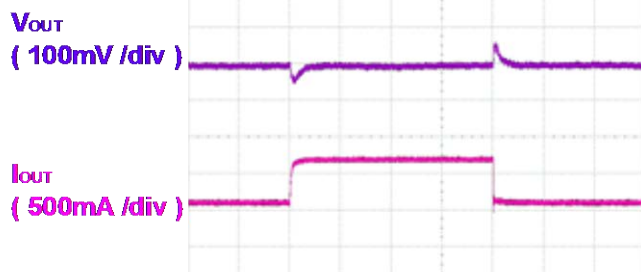

50us/div

R1245x00xG/R1245x00xH

$V_{OUT}=3.3V$  ,  $V_{IN}=12V$  ,  $I_{OUT}=600\leftrightarrow 1200mA$  ,  $T_a=25^\circ C$

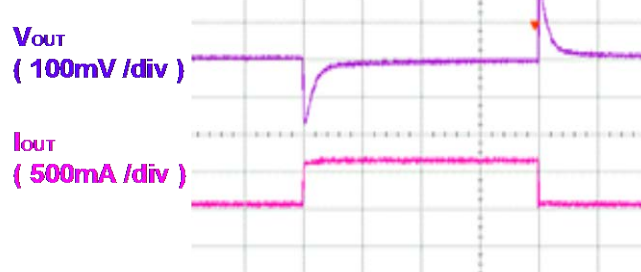

50us/div

16) Limit latch operation waveform

R1245x00xA

$V_{OUT}=3.3V$  ,  $V_{IN}=12V$  ,  $R_{OUT}=5.5\Omega \rightarrow 0.05\Omega$  ,  $T_a=25^\circ C$

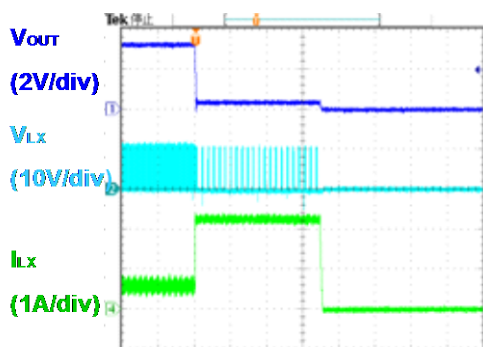

1ms/div

17) Released waveform from limit latch

R1245x00xA

$V_{OUT}=3.3V$  ,  $V_{IN}=12V$  ,  $R_{OUT}=5.5\Omega \rightarrow 0.05\Omega \rightarrow 5.5\Omega$  ,  $T_a=25^\circ C$

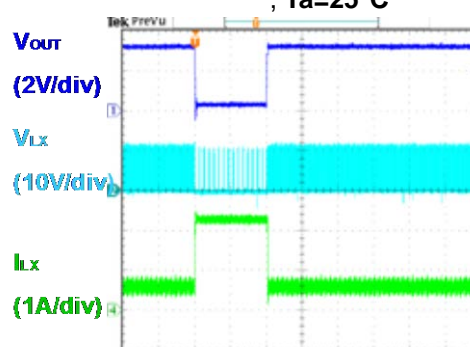

1ms/div

18) Fold back operation waveform

R1245x00xB

$V_{OUT}=3.3V$  ,  $V_{IN}=12V$  ,  $R_{OUT}=5.5\Omega \rightarrow 0.05\Omega$  ,  $T_a=25^\circ C$

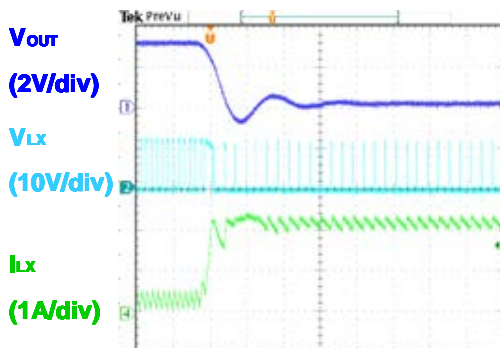

20us/div

19) Released waveform from fold back

R1245x00xB

$V_{OUT}=3.3V$  ,  $V_{IN}=12V$  ,  $R_{OUT}=5.5\Omega \rightarrow 0.05\Omega \rightarrow 5.5\Omega$  ,  $T_a=25^\circ C$

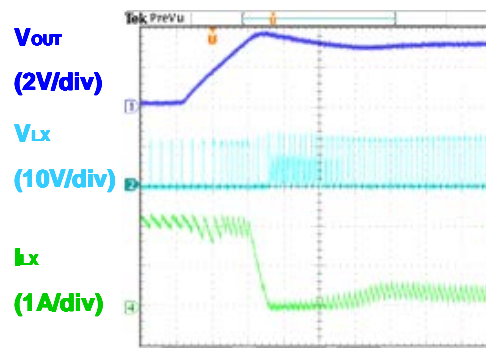

20us/div

# R1245x

NO.EA-269-160225

## 20) Switching waveform at fold back operation

R1245x00xB

$V_{OUT}=3.3V$  ,  $V_{IN}=12V$  ,  $R_{OUT}=0.05\Omega$  ,  $T_a=25^\circ C$

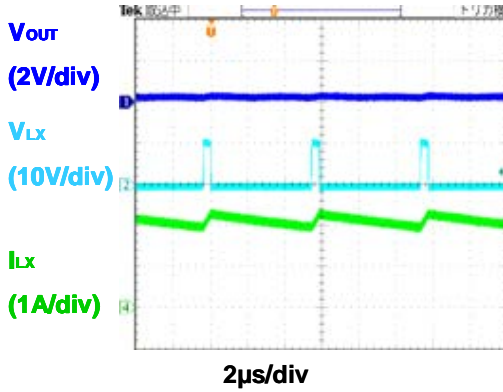

## 21) Output current vs. Efficiency (Version A/B)

R1245x00xA/R1245x00xB

$V_{OUT}=0.8V$

( $T_a=25^\circ C$ )

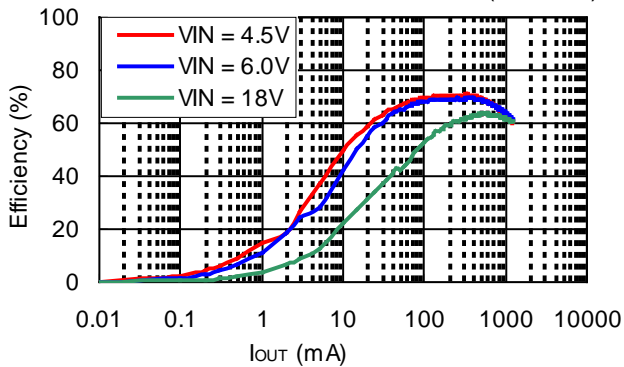

R1245x00xA/R1245x00xB

$V_{OUT}=3.3V$

( $T_a=25^\circ C$ )

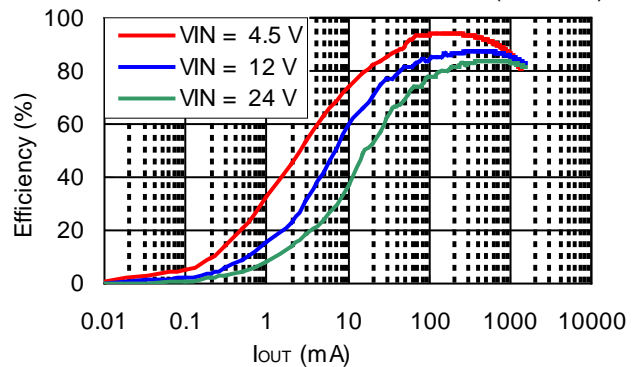

R1245x00xA/R1245x00xB

$V_{OUT}=5.0V$

( $T_a=25^\circ C$ )

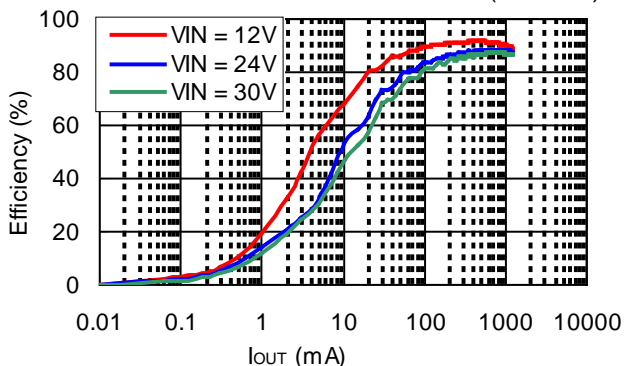

R1245x00xA/R1245x00xB

$V_{OUT}=12V$

( $T_a=25^\circ C$ )

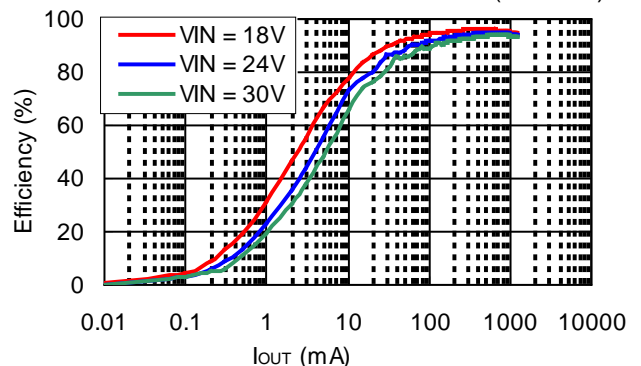

R1245x00xA/R1245x00xB  
V<sub>OUT</sub>=15V

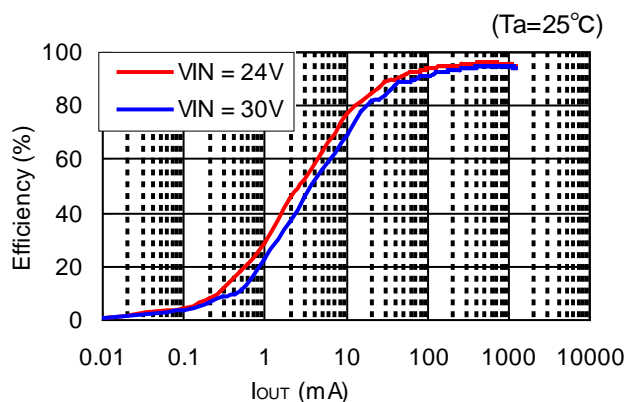

R1245x00xA/R1245x00xB  
V<sub>OUT</sub>=24V

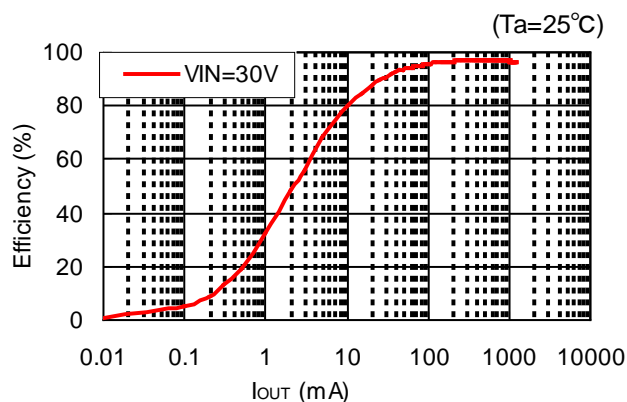

22) Output Current vs. Efficiency (Version C/D)

R1245x00xC/R1245x00xD  
V<sub>OUT</sub>=0.8V

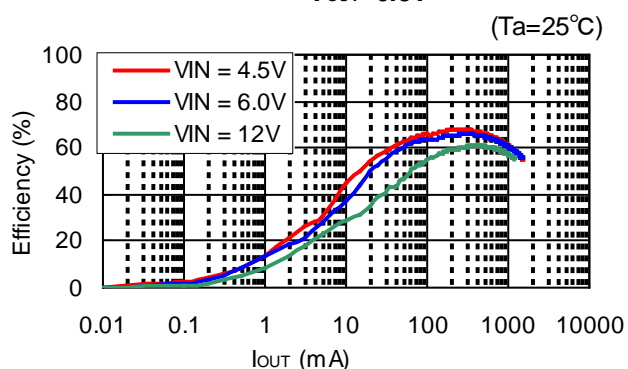

R1245x00xC/R1245x00xD  
V<sub>OUT</sub>=3.3V

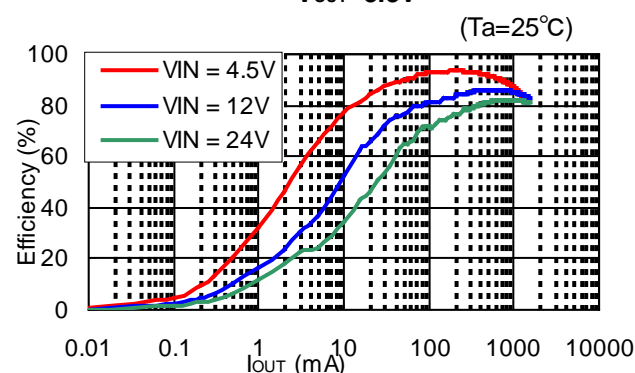

R1245x00xC/R1245x00xD  
V<sub>OUT</sub>=5.0V

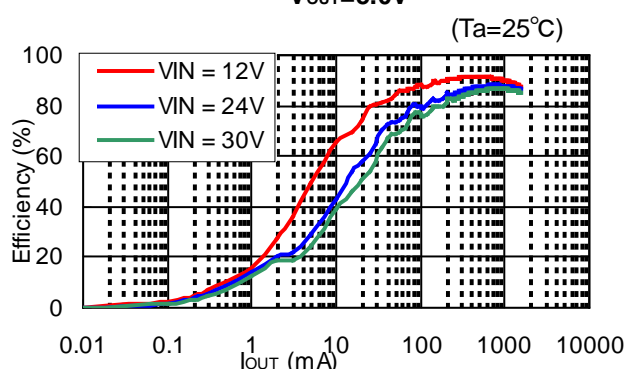

R1245x00xC/R1245x00xD  
V<sub>OUT</sub>=12V

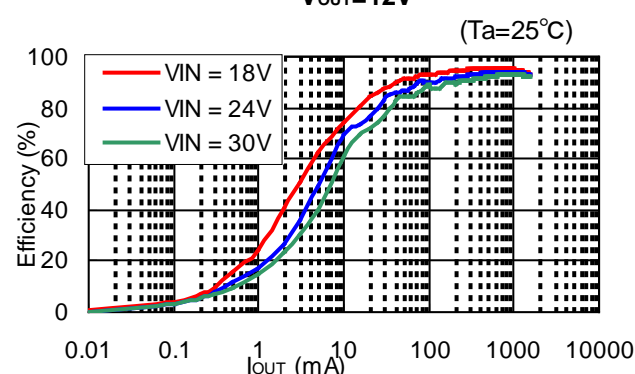

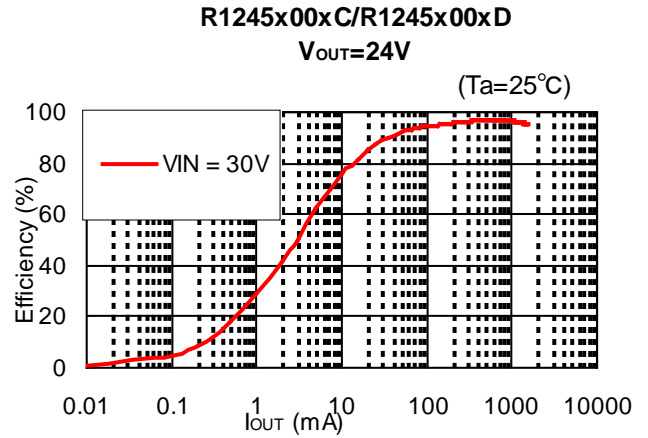
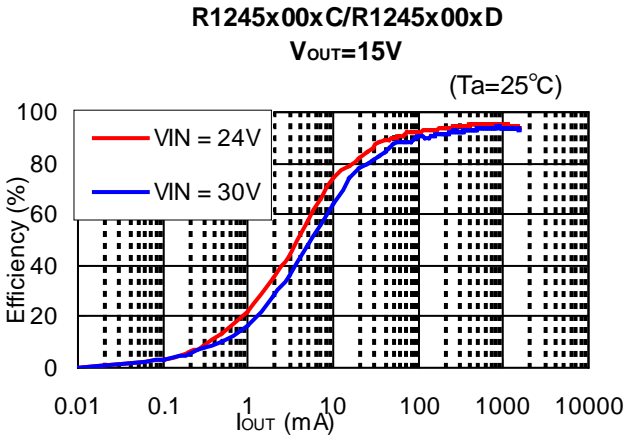

**23) Output current vs. Efficiency (Version E/F)**

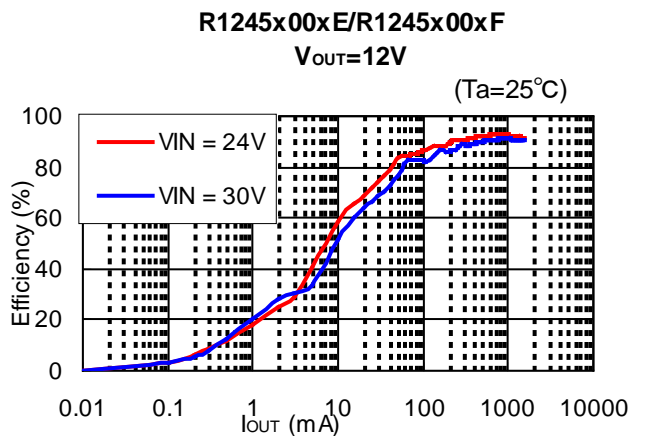
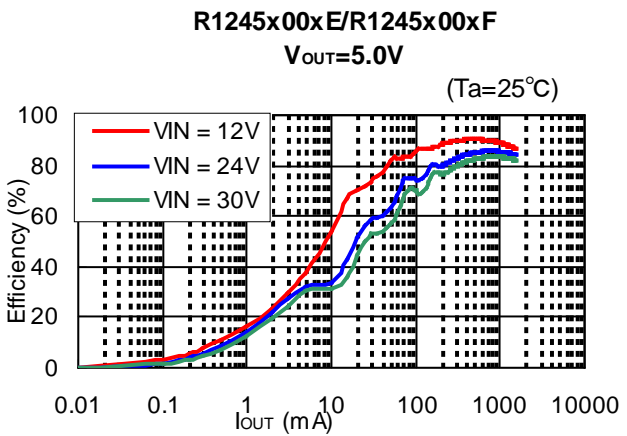
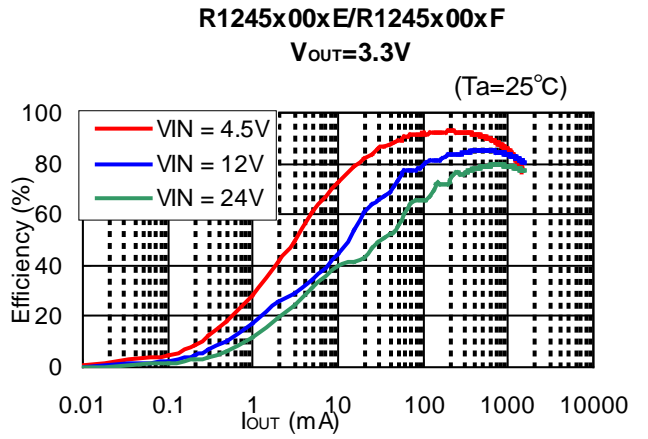
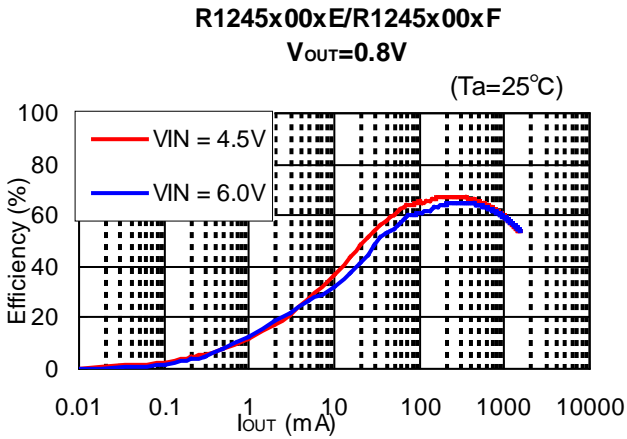

R1245x00xE/R1245x00xF  
V<sub>OUT</sub>=15V

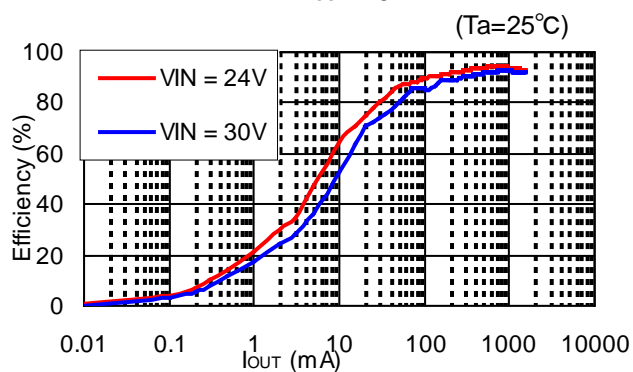

R1245x00xE/R1245x00xF  
V<sub>OUT</sub>=24V

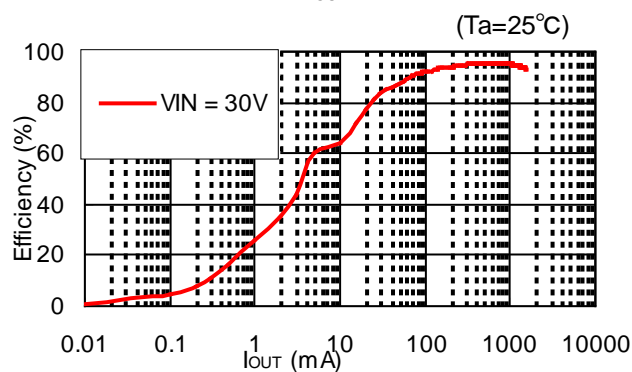

24) Output current vs. Efficiency (Version G/H)

R1245x00xG/R1245x00xH  
V<sub>OUT</sub>=1.5V

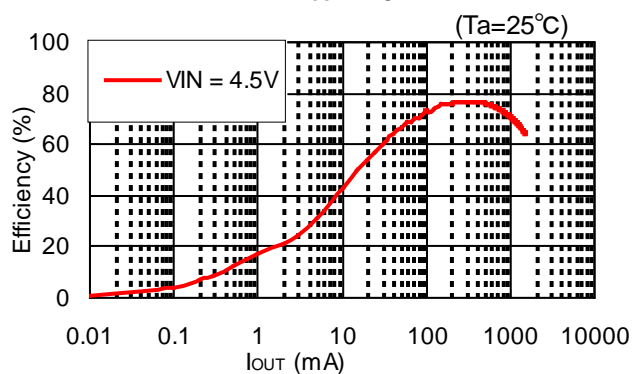

R1245x00xG/R1245x00xH  
V<sub>OUT</sub>=3.3V

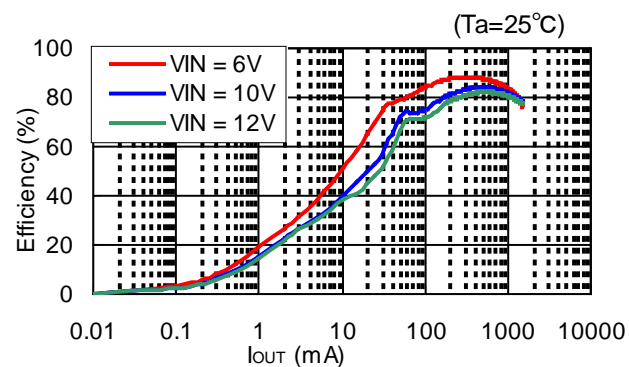

R1245x00xG/R1245x00xH  
V<sub>OUT</sub>=5.0V

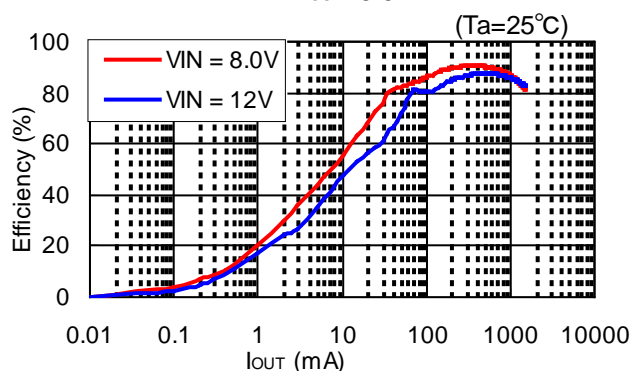

R1245x00xG/R1245x00xH  
V<sub>OUT</sub>=12V

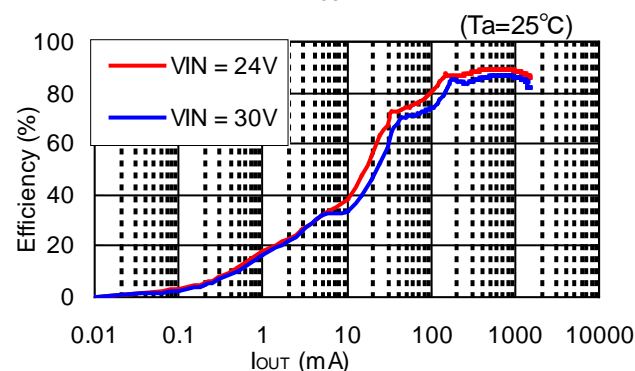

**25) Output current vs Output voltage (Version A/B)**

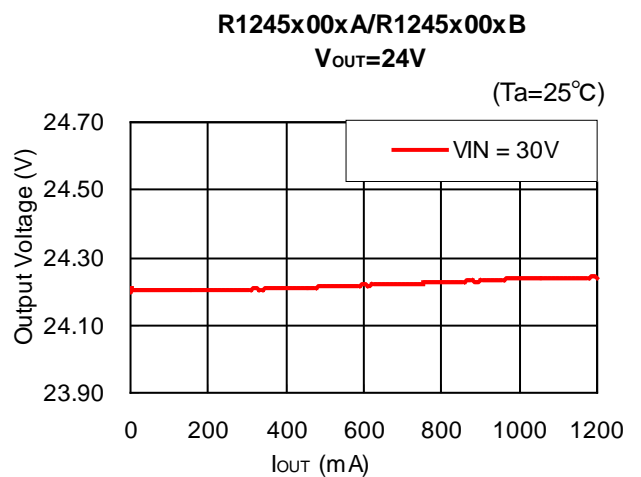
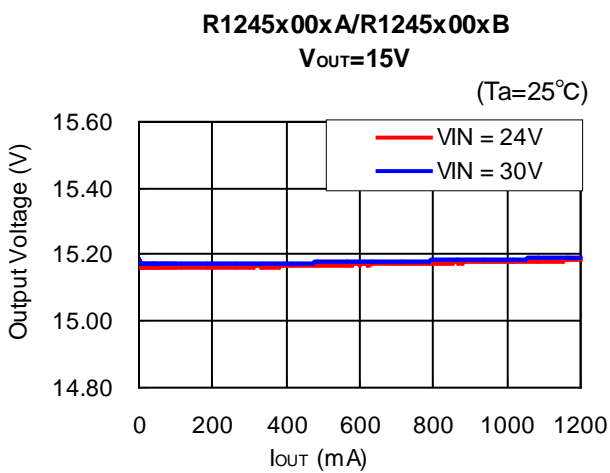
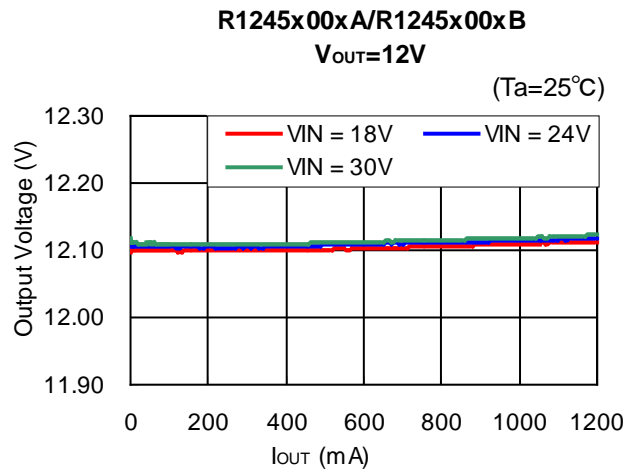
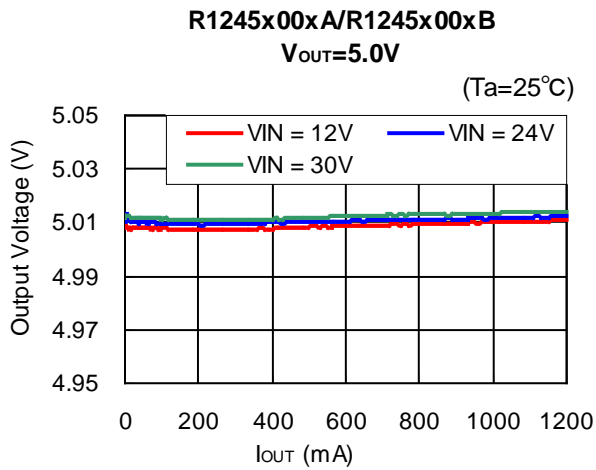
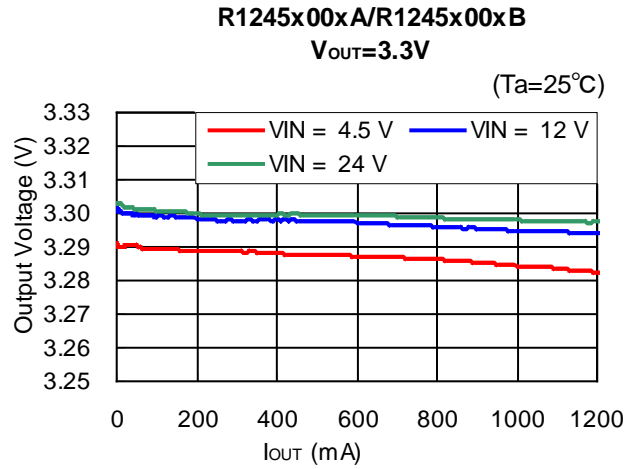
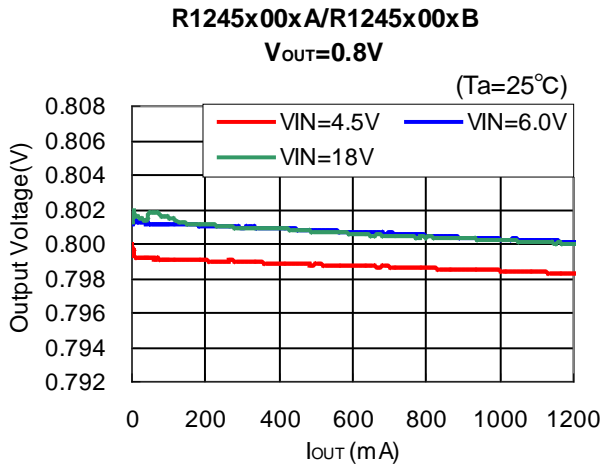

26) Output current vs. Output voltage (Version C/D)

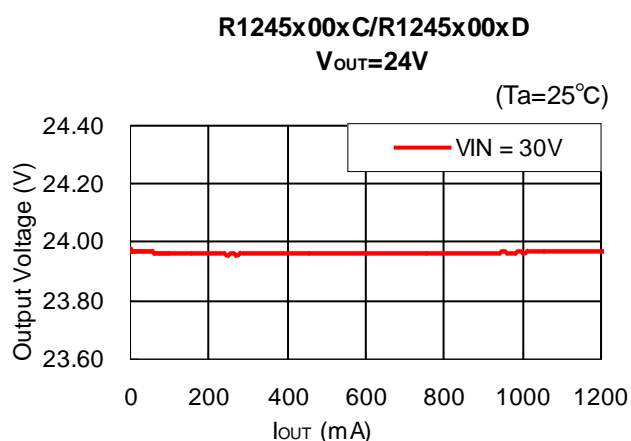
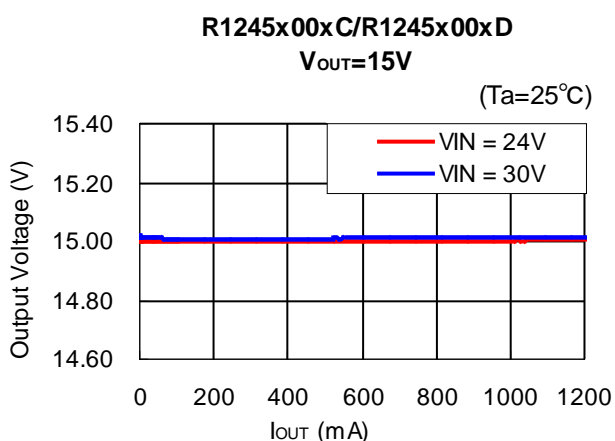
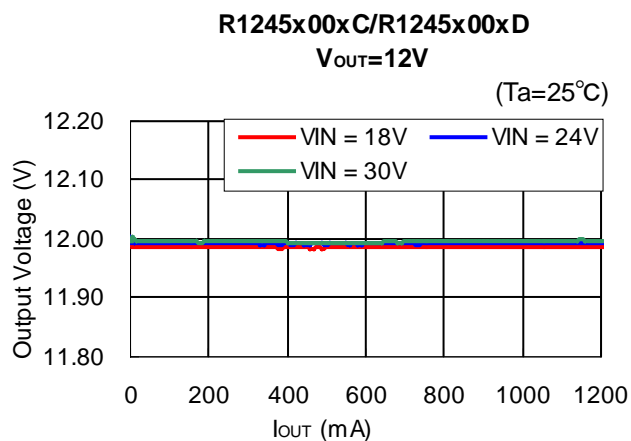
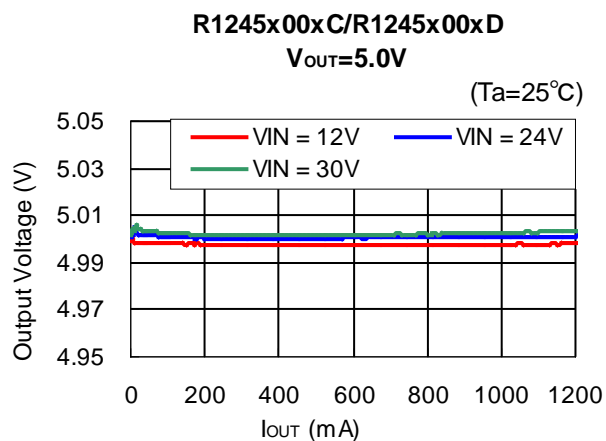
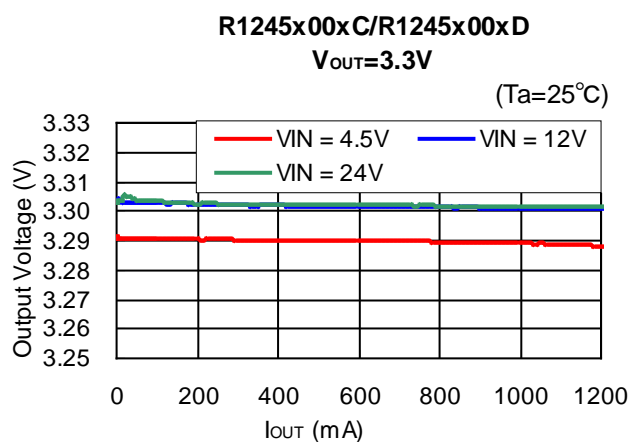
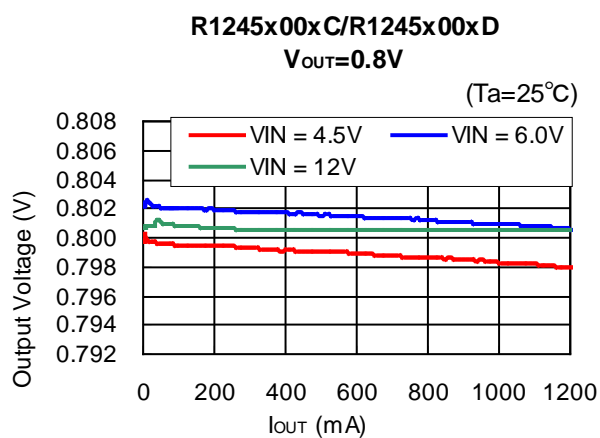

# R1245x

NO.EA-269-160225

## 27) Output current vs. Output voltage (Version E/F)

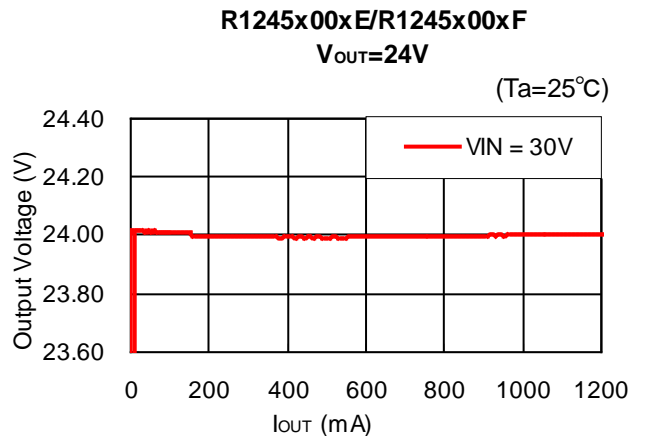
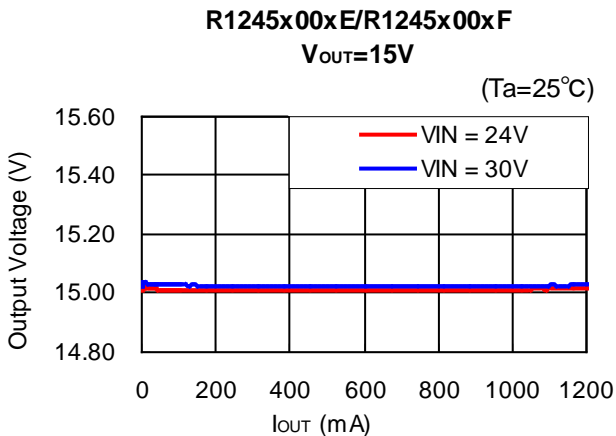
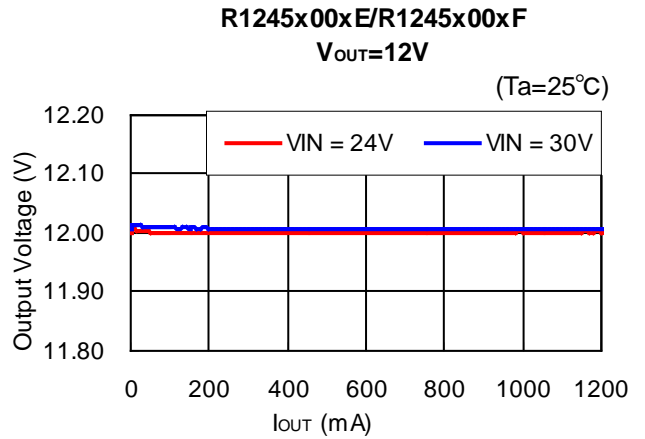
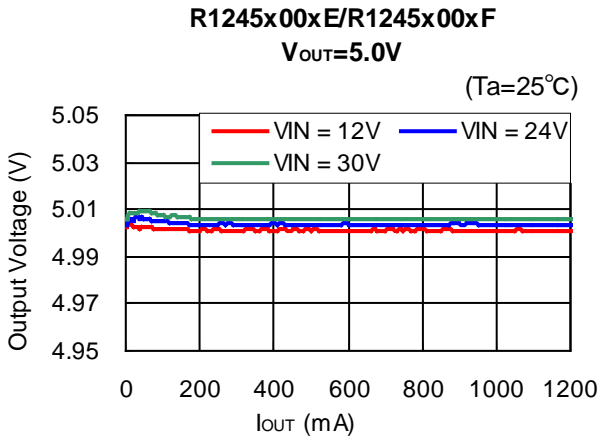
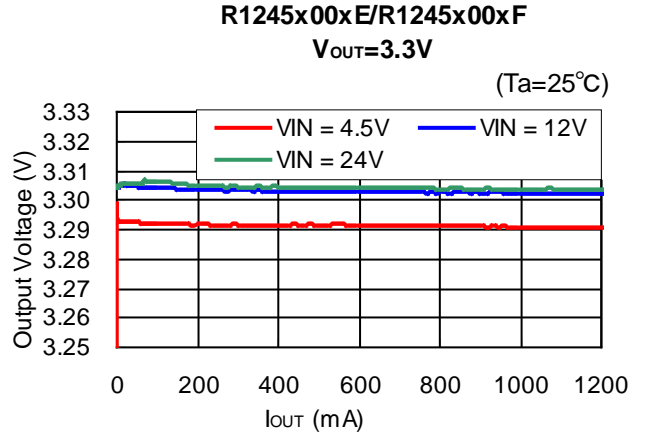
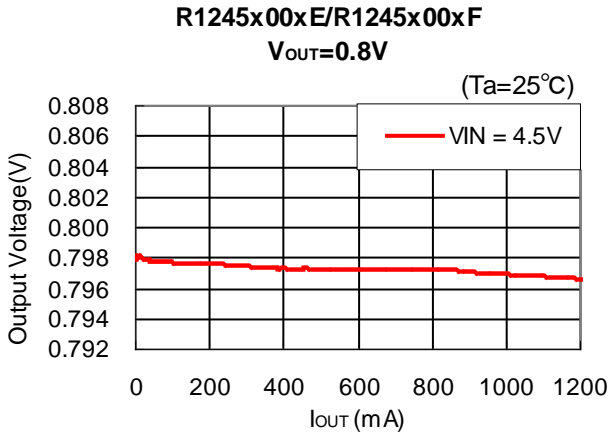



28) Output current vs. Output voltage (Version G/H)

R1245x00xG/R1245x00xH  
V<sub>OUT</sub>=1.5V

(Ta=25°C)

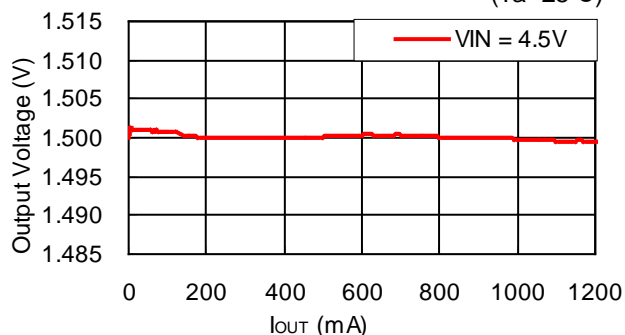

R1245x00xG/R1245x00xH  
V<sub>OUT</sub>=3.3V

(Ta=25°C)

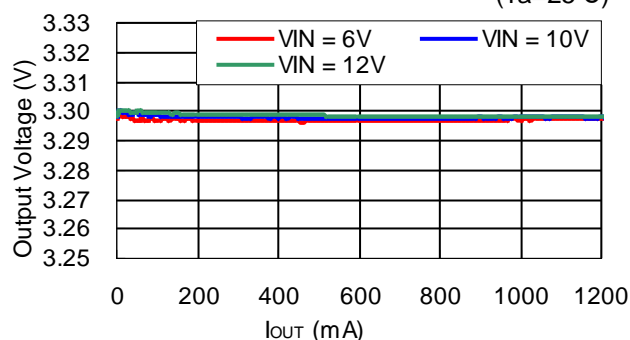

R1245x00xG/R1245x00xH  
V<sub>OUT</sub>=5.0V

(Ta=25°C)

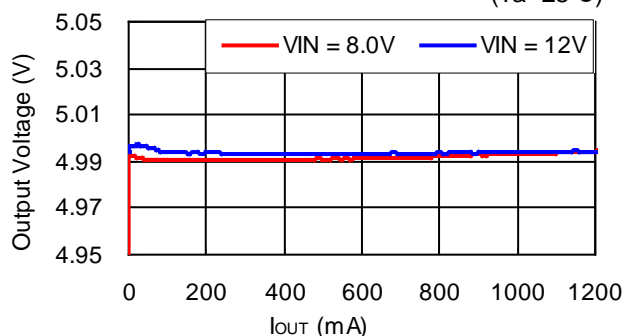

R1245x00xG/R1245x00xH  
V<sub>OUT</sub>=12V

(Ta=25°C)

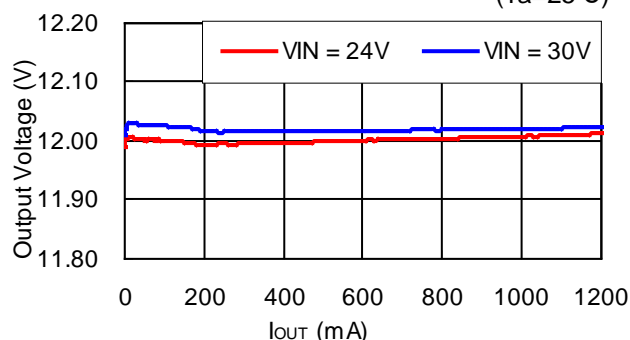

29) Input voltage vs. Output voltage (Version A/B)

R1245x00xA/R1245x00xB  
V<sub>OUT</sub>=0.8V

(Ta=25°C)

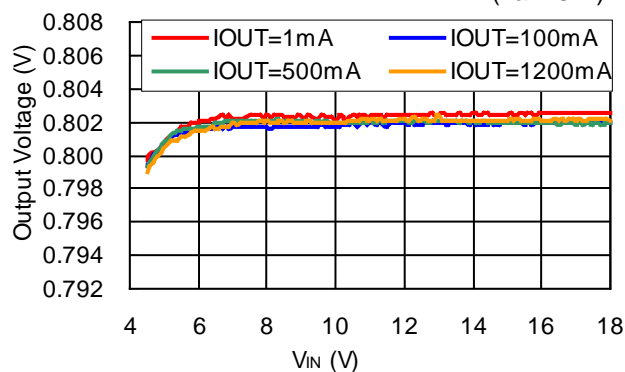

R1245x00xA/R1245x00xB  
V<sub>OUT</sub>=3.3V

(Ta=25°C)

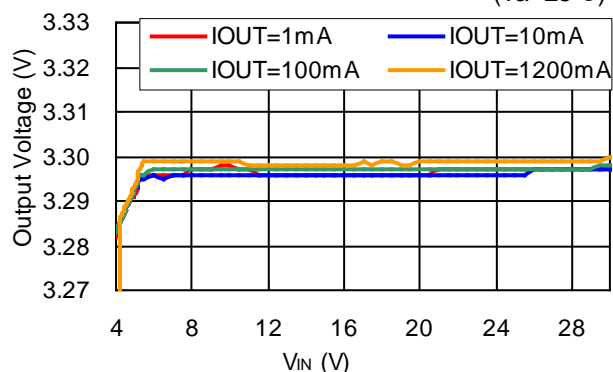

# R1245x

NO.EA-269-160225

**R1245x00xA/R1245x00xB**  
**V<sub>OUT</sub>=5.0V**

(Ta=25°C)

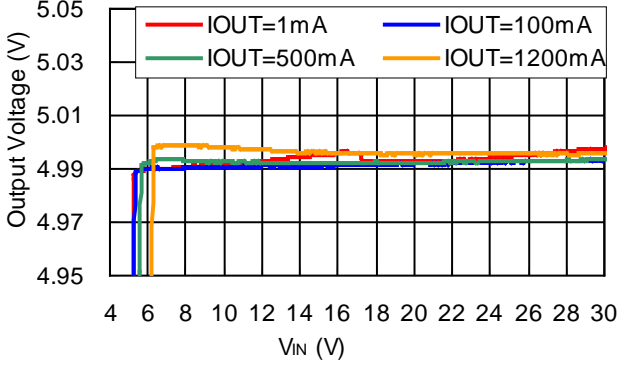

**R1245x00xA/R1245x00xB**  
**V<sub>OUT</sub>=12V**

(Ta=25°C)

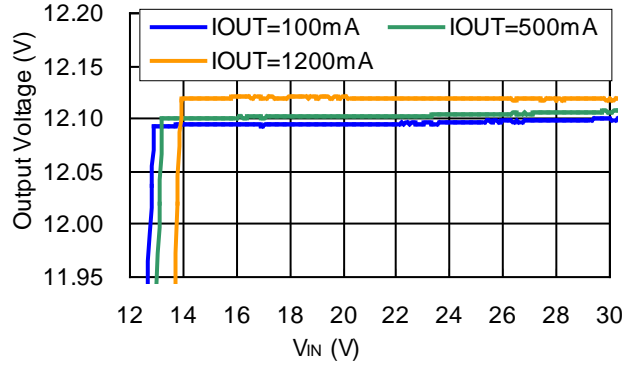

**R1245x00xA/R1245x00xB**  
**V<sub>OUT</sub>=15V**

(Ta=25°C)

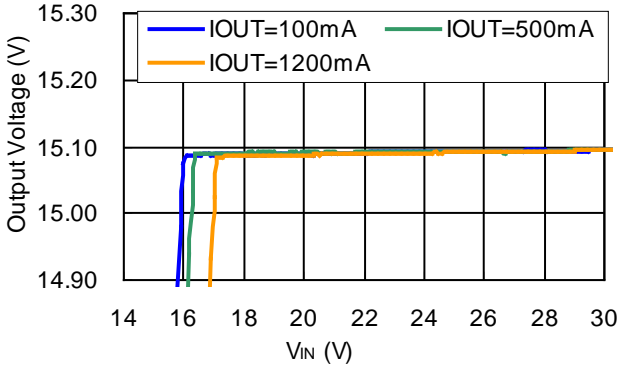

**R1245x00xA/R1245x00xB**  
**V<sub>OUT</sub>=24V**

(Ta=25°C)

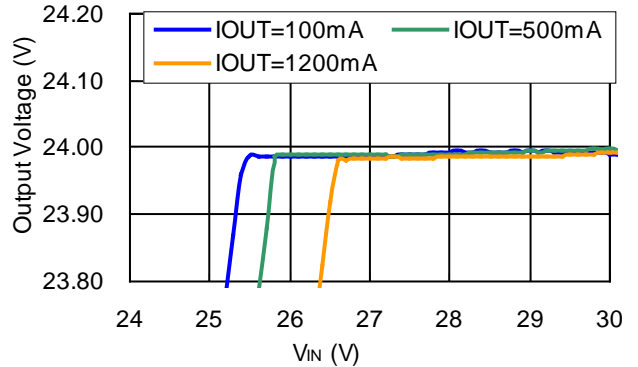

## 30) Input voltage vs. Output voltage (Version C/D)

**R1245x00xC/R1245x00xD**  
**V<sub>OUT</sub>=0.8V**

(Ta=25°C)

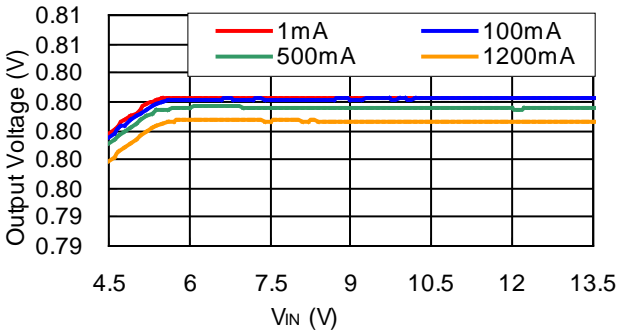

**R1245x00xC/R1245x00xD**  
**V<sub>OUT</sub>=3.3V**

(Ta=25°C)

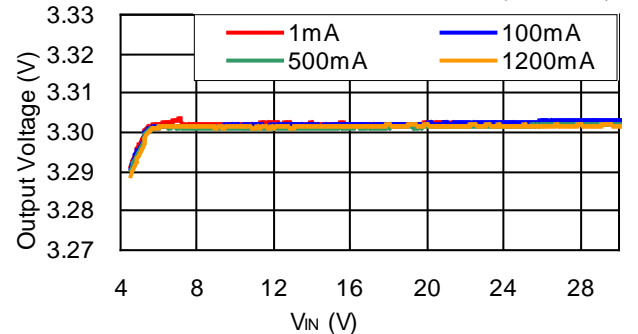

R1245x00xC/R1245x00xD  
V<sub>OUT</sub>=5.0V

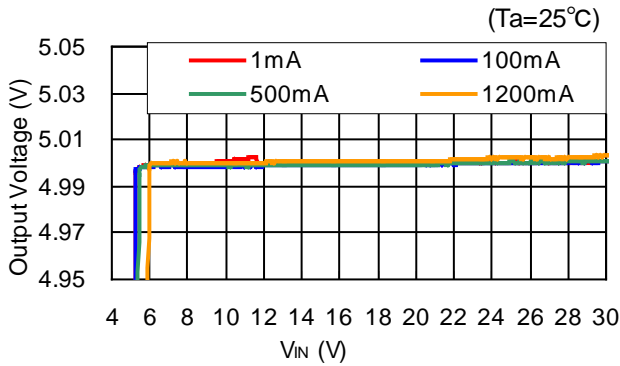

R1245x00xC/R1245x00xD  
V<sub>OUT</sub>=12V

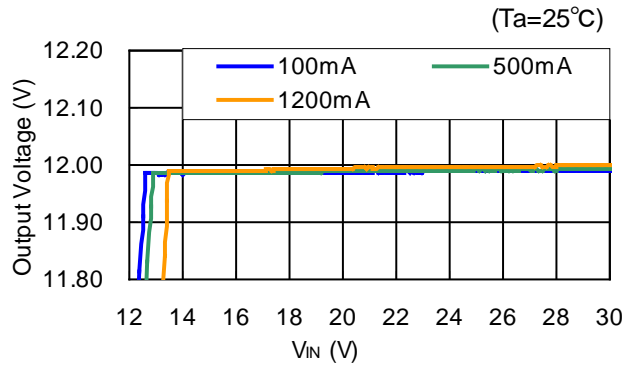

R1245x00xC/R1245x00xD  
V<sub>OUT</sub>=15V

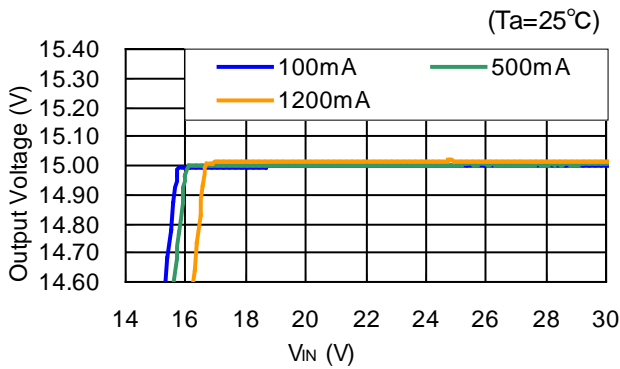

R1245x00xC/R1245x00xD  
V<sub>OUT</sub>=24V

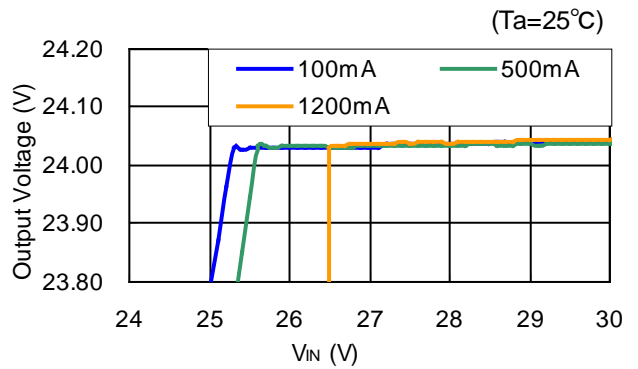

31) Input voltage vs. Output voltage (Version E/F)

R1245x00xE/R1245x00xF  
V<sub>OUT</sub>=0.8V

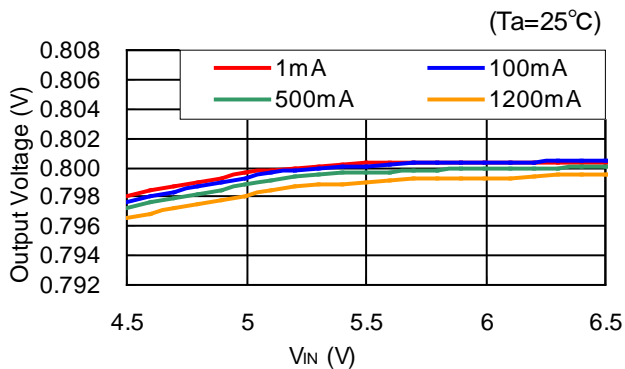

R1245x00xE/R1245x00xF  
V<sub>OUT</sub>=3.3V

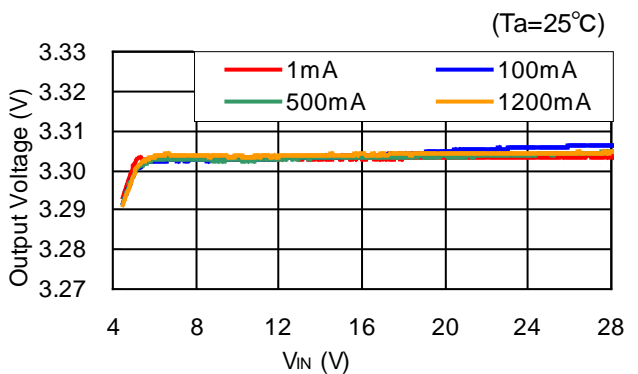

# R1245x

NO.EA-269-160225

**R1245x00xE/R1245x00xF**  
**V<sub>OUT</sub>=5.0V**

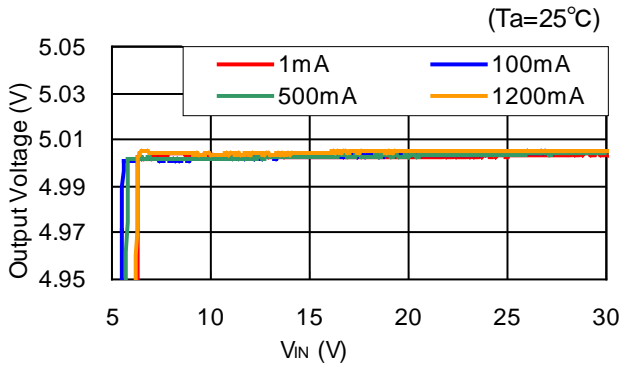

**R1245x00xE/R1245x00xF**  
**V<sub>OUT</sub>=12V**

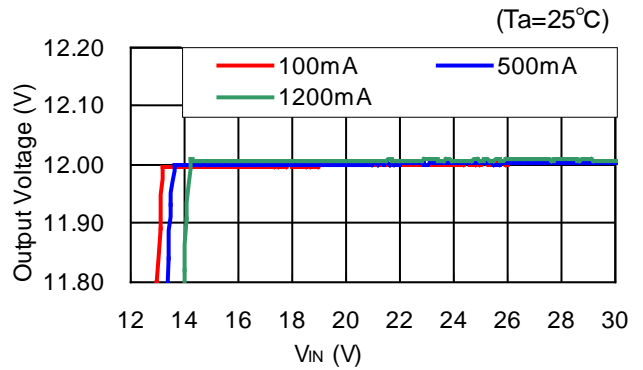

**R1245x00xE/R1245x00xF**  
**V<sub>OUT</sub>=15V**

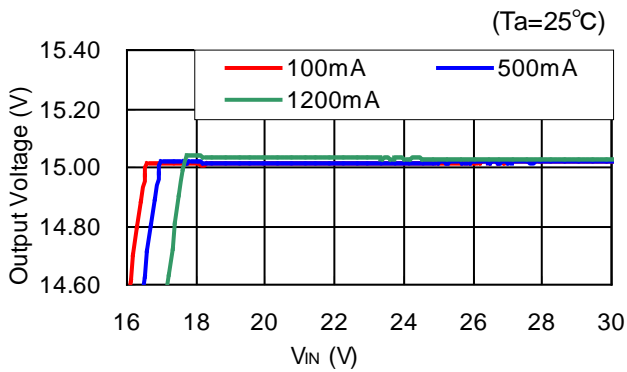

**R1245x00xE/R1245x00xF**  
**V<sub>OUT</sub>=24V**

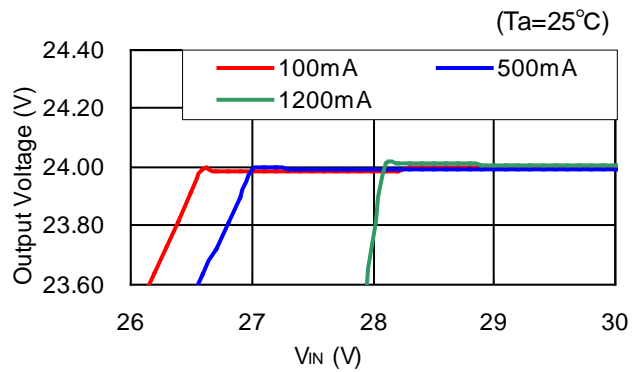

## 32) Input voltage vs. Output voltage (Version G/H)

**R1245x00xG/R1245x00xH**  
**V<sub>OUT</sub>=1.5V**

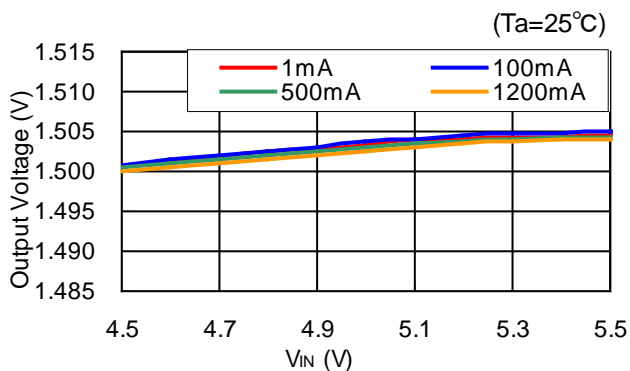

**R1245x00xG/R1245x00xH**  
**V<sub>OUT</sub>=3.3V**

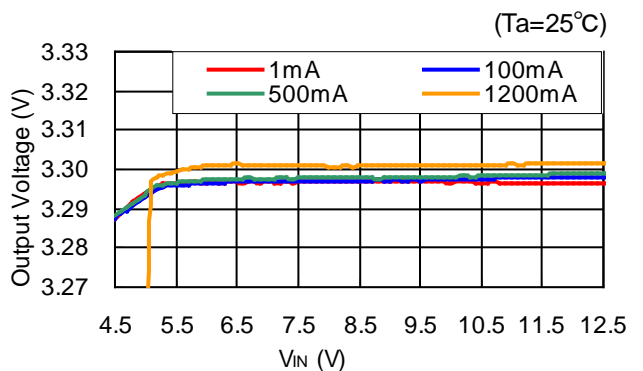

R1245x00xG/R1245x00xH

V<sub>OUT</sub>=5.0V

(Ta=25°C)

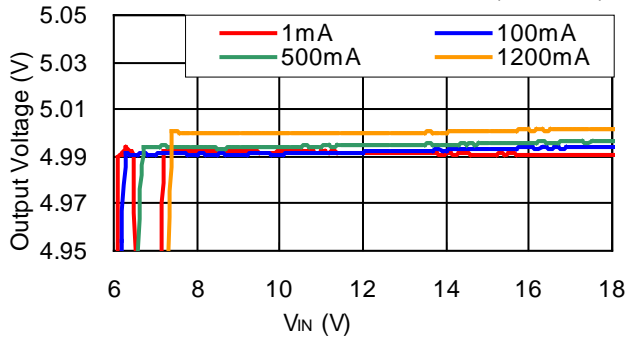

R1245x00xG/R1245x00xH

V<sub>OUT</sub>=12V

(Ta=25°C)

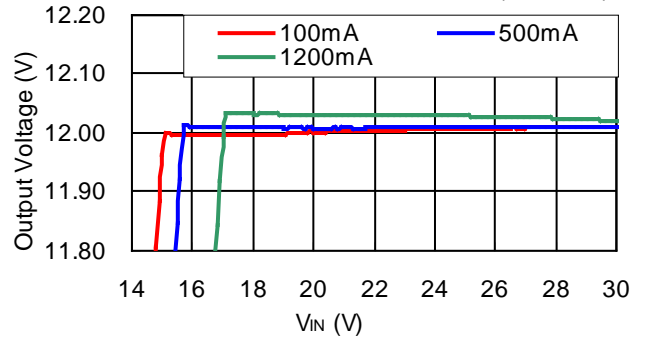



1. The products and the product specifications described in this document are subject to change or discontinuation of production without notice for reasons such as improvement. Therefore, before deciding to use the products, please refer to Ricoh sales representatives for the latest information thereon.
2. The materials in this document may not be copied or otherwise reproduced in whole or in part without prior written consent of Ricoh.
3. Please be sure to take any necessary formalities under relevant laws or regulations before exporting or otherwise taking out of your country the products or the technical information described herein.
4. The technical information described in this document shows typical characteristics of and example application circuits for the products. The release of such information is not to be construed as a warranty of or a grant of license under Ricoh's or any third party's intellectual property rights or any other rights.
5. The products listed in this document are intended and designed for use as general electronic components in standard applications (office equipment, telecommunication equipment, measuring instruments, consumer electronic products, amusement equipment etc.). Those customers intending to use a product in an application requiring extreme quality and reliability, for example, in a highly specific application where the failure or misoperation of the product could result in human injury or death (aircraft, spacevehicle, nuclear reactor control system, traffic control system, automotive and transportation equipment, combustion equipment, safety devices, life support system etc.) should first contact us.
6. We are making our continuous effort to improve the quality and reliability of our products, but semiconductor products are likely to fail with certain probability. In order to prevent any injury to persons or damages to property resulting from such failure, customers should be careful enough to incorporate safety measures in their design, such as redundancy feature, fire containment feature and fail-safe feature. We do not assume any liability or responsibility for any loss or damage arising from misuse or inappropriate use of the products.
7. Anti-radiation design is not implemented in the products described in this document.
8. Please contact Ricoh sales representatives should you have any questions or comments concerning the products or the technical information.



**Ricoh is committed to reducing the environmental loading materials in electrical devices with a view to contributing to the protection of human health and the environment.**

Ricoh has been providing RoHS compliant products since April 1, 2006 and Halogen-free products since April 1, 2012.

**RICOH** RICOH ELECTRONIC DEVICES CO., LTD.

<http://www.e-devices.ricoh.co.jp/en/>

#### Sales & Support Offices

##### **RICOH ELECTRONIC DEVICES CO., LTD.**

**Higashi-Shinagawa Office (International Sales)**  
3-32-3, Higashi-Shinagawa, Shinagawa-ku, Tokyo 140-8655, Japan  
Phone: +81-3-5479-2857 Fax: +81-3-5479-0502

##### **RICOH EUROPE (NETHERLANDS) B.V.**

**Semiconductor Support Centre**  
Prof. W.H. Keesomlaan 1, 1183 DJ Amstelveen, The Netherlands  
Phone: +31-20-5474-309

##### **RICOH INTERNATIONAL B.V. - German Branch**

**Semiconductor Sales and Support Centre**  
Oberrather Strasse 6, 40472 Düsseldorf, Germany  
Phone: +49-211-6546-0

##### **RICOH ELECTRONIC DEVICES KOREA CO., LTD.**

3F, Haesung Bldg, 504, Teheran-ro, Gangnam-gu, Seoul, 135-725, Korea  
Phone: +82-2-2135-5700 Fax: +82-2-2051-5713

##### **RICOH ELECTRONIC DEVICES SHANGHAI CO., LTD.**

Room 403, No.2 Building, No.690 Bibo Road, Pu Dong New District, Shanghai 201203, People's Republic of China  
Phone: +86-21-5027-3200 Fax: +86-21-5027-3299

##### **RICOH ELECTRONIC DEVICES CO., LTD.**

**Taipei office**  
Room 109, 10F-1, No.51, Hengyang Rd., Taipei City, Taiwan (R.O.C.)  
Phone: +886-2-2313-1621/1622 Fax: +886-2-2313-1623

# Mouser Electronics

Authorized Distributor

Click to View Pricing, Inventory, Delivery & Lifecycle Information:

[Ricoch Electronics:](#)

[R1245N001D-TR-FE](#) [R1245S003E-E2-FE](#) [R1245N001G-TR-FE](#)

Компания «Океан Электроники» предлагает заключение долгосрочных отношений при поставках импортных электронных компонентов на взаимовыгодных условиях!

Наши преимущества:

- Поставка оригинальных импортных электронных компонентов напрямую с производств Америки, Европы и Азии, а так же с крупнейших складов мира;
- Широкая линейка поставок активных и пассивных импортных электронных компонентов (более 30 млн. наименований);
- Поставка сложных, дефицитных, либо снятых с производства позиций;
- Оперативные сроки поставки под заказ (от 5 рабочих дней);
- Экспресс доставка в любую точку России;
- Помощь Конструкторского Отдела и консультации квалифицированных инженеров;
- Техническая поддержка проекта, помощь в подборе аналогов, поставка прототипов;
- Поставка электронных компонентов под контролем ВП;
- Система менеджмента качества сертифицирована по Международному стандарту ISO 9001;
- При необходимости вся продукция военного и аэрокосмического назначения проходит испытания и сертификацию в лаборатории (по согласованию с заказчиком);
- Поставка специализированных компонентов военного и аэрокосмического уровня качества (Xilinx, Altera, Analog Devices, Intersil, Interpoint, Microsemi, Actel, Aeroflex, Peregrine, VPT, Syfer, Eurofarad, Texas Instruments, MS Kennedy, Miteq, Cobham, E2V, MA-COM, Hittite, Mini-Circuits, General Dynamics и др.);

Компания «Океан Электроники» является официальным дистрибьютором и эксклюзивным представителем в России одного из крупнейших производителей разъемов военного и аэрокосмического назначения «JONHON», а так же официальным дистрибьютором и эксклюзивным представителем в России производителя высокотехнологичных и надежных решений для передачи СВЧ сигналов «FORSTAR».



## JONHON

«JONHON» (основан в 1970 г.)

Разъемы специального, военного и аэрокосмического назначения:

(Применяются в военной, авиационной, аэрокосмической, морской, железнодорожной, горно- и нефтедобывающей отраслях промышленности)

«FORSTAR» (основан в 1998 г.)

ВЧ соединители, коаксиальные кабели, кабельные сборки и микроволновые компоненты:

(Применяются в телекоммуникациях гражданского и специального назначения, в средствах связи, РЛС, а так же военной, авиационной и аэрокосмической отраслях промышленности).



Телефон: 8 (812) 309-75-97 (многоканальный)

Факс: 8 (812) 320-03-32

Электронная почта: [ocean@oceanchips.ru](mailto:ocean@oceanchips.ru)

Web: <http://oceanchips.ru/>

Адрес: 198099, г. Санкт-Петербург, ул. Калинина, д. 2, корп. 4, лит. А