

GP1S396HCPSF

Gap : 1.2mm Slit : 0.12mm
Phototransistor Output,
Compact Transmissive
Photointerrupter



■Description

GP1S396HCPSF is a phototransistor output, transmissive photointerrupter with a industry's smallest compact and low-profile package by the thin molding technology. This product detects an object between the emitter and the detector.
In addition, by narrowing the slit width of the infrared beam to 0.12mm, this product has improved detection accuracy.

■Features

1. Transmissive with phototransistor output
2. Highlights :
 - Compact size
 - Low Profile
 - Narrow Gap
3. Key Parameters :
 - Gap Width : 1.2mm
 - Slit Width (detector side) : 0.12mm
 - Package : 2.26 × 1.4 × 1.6mm
4. RoHS directive compliant

■Agency approvals/Compliance

1. Compliant with RoHS directive (2002/95/EC)

■Applications

1. General purpose detection of object presence or motion.
Example : printer, lens control for camera,
various mechanical position detection

Notice The content of data sheet is subject to change without prior notice.
In the absence of confirmation by device specification sheets, SHARP takes no responsibility for any defects that may occur in equipment using any SHARP devices shown in catalogs, data books, etc. Contact SHARP in order to obtain the latest device specification sheets before using any SHARP device.

Sheet No.: OP13020EN

■ Internal Connection Diagram

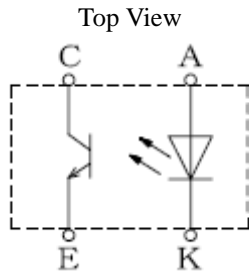

A : Anode
 K : Cathode
 C : Collector
 E : Emitter

■ Outline Dimensions

Drawing No. CY14942i02

Scale : 15/1 Unit : mm

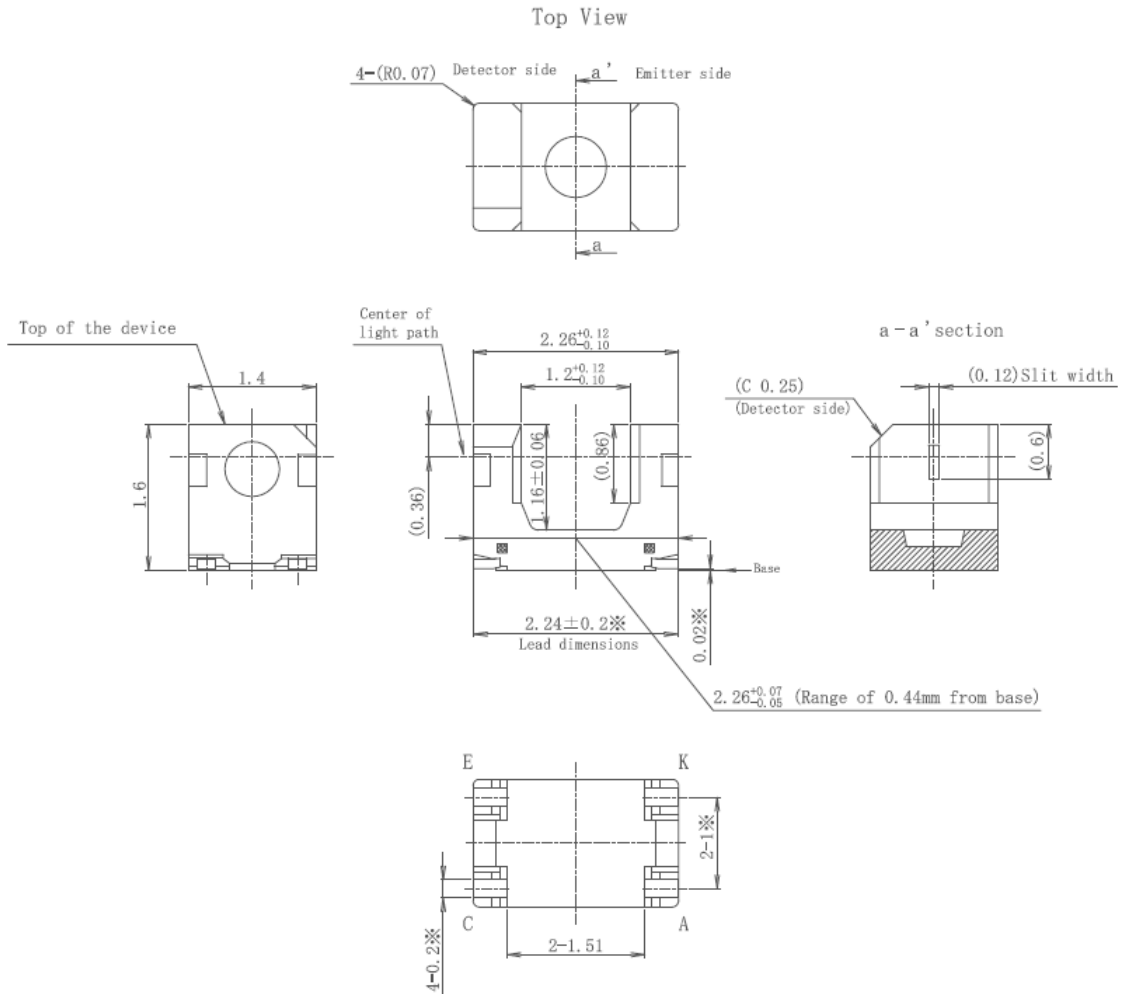

<Reference>
 Recommended soldering pattern dimensions

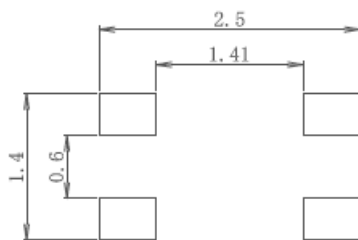

Note

- 1) Unspecified tolerance shall be ± 0.08mm.
- 2) Dimensions in parenthesis are shown for reference.
- 3) The dimensions indicated by ※ refer to the those measured from the lead base.
- 4) The dimensions shown do not include those of burrs. Burr's dimensions shall be 0.15Max.
- 5) There is a possibility that the lead of  part is exposed.
- 6) There is a possibility that the internal device is exposed at the top of the device because of the thin thickness of the outer package.
- 7) The recommendation pattern receives the influence of reflow soldering and solder type etc.. Sufficiently after doing the verification of mounting, please decide.

■ Absolute maximum ratings

Ta=25°C

Parameter		Symbol	Rating	Unit
Input	Forward current	I _F	30	mA
	Reverse voltage	V _R	6	V
	Power dissipation	P	50	mW
Output	Collector-emitter voltage	V _{CEO}	35	V
	Emitter-collector voltage	V _{ECO}	6	V
	Collector current	I _c	20	mA
	Collector power dissipation	P _c	50	mW
Total power dissipation		P _{tot}	70	mW
Operating temperature		T _{opr}	-25 to +85	°C
Storage temperature		T _{stg}	-40 to +100	°C
* Soldering temperature		T _{sol}	300	°C

* Soldering time : 3 s or less

■ Electro-optical Characteristics

Ta=25°C

Parameter		Symbol	Conditions	MIN.	TYP.	MAX.	Unit	
Input	Forward voltage	V _F	I _F =20mA	-	1.2	1.4	V	
	Reverse current	I _R	V _R =3V	-	-	10	μA	
Output	Collector dark current	I _{CEO}	V _{CE} =20V	-	-	100	nA	
Transfer characteristics	Collector current	I _c	V _{CE} =5V, I _F =5mA	100	-	400	μA	
	Response time	(Rise)	t _r	V _{CE} =5V, I _c =100μA R _L =1kΩ	-	30	120	μs
		(Fall)	t _f		-	30	120	μs
Collector-emitter saturation voltage		V _{CE(sat)}	I _F =10mA, I _c =40μA	-	-	0.4	V	

(Test circuit for response time)

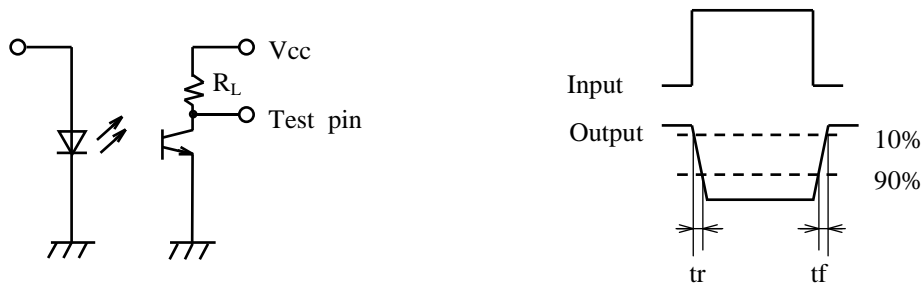

Forward current vs. ambient temperature

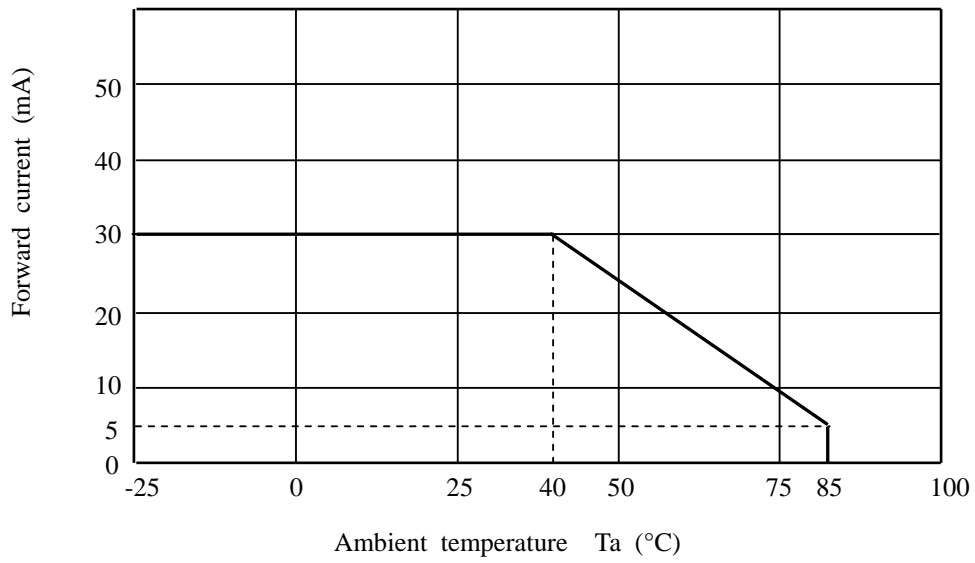

Power dissipation vs. ambient temperature

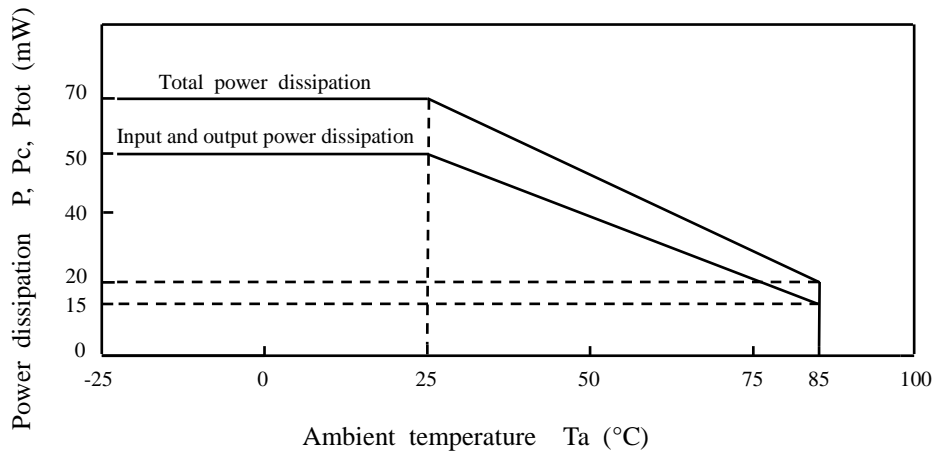

Relative collector current vs. shield distance 1 (Reference value)

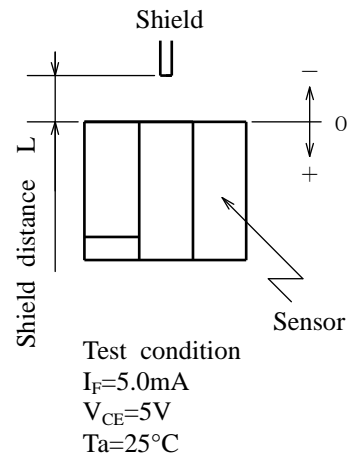
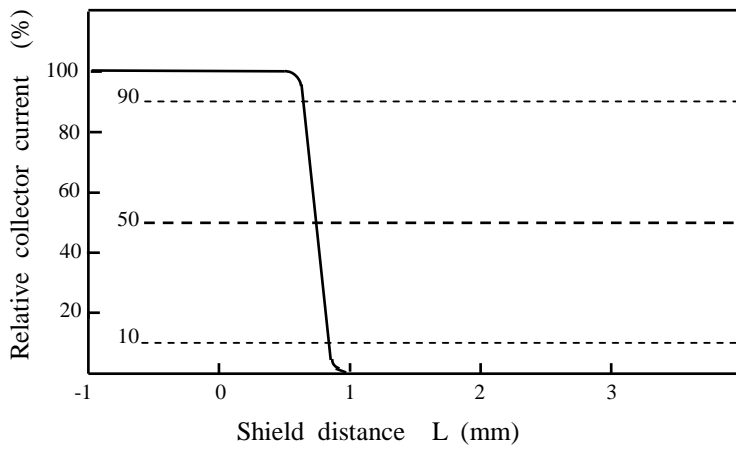

Relative collector current vs. shield distance 2 (Reference value)

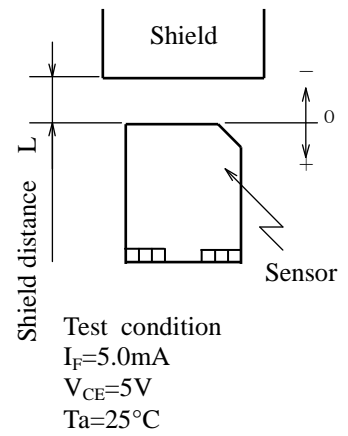
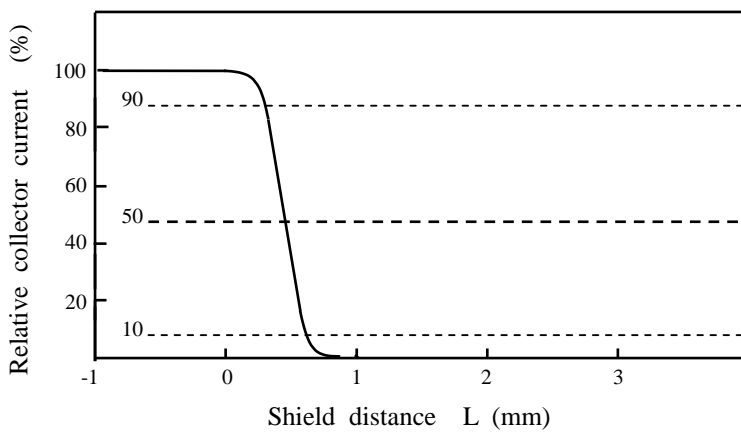

■ **Supplements**

● ODS materials

This product shall not contain the following materials.

Also, the following materials shall not be used in the production process for this product.

Materials for ODS : CFC_s, Halon, Carbon tetrachloride 1.1.1-Trichloroethane (Methyl chloroform)

● Halogen material

Chlorine < 900ppm , Bromine < 900ppm , Chlorine + Bromine < 1500ppm (Homogeneous material)

● Compliance with each regulation

1) The RoHS directive(2002/95/EC)

This product complies with the RoHS directive(2002/95/EC).

Object substances: mercury, lead, cadmium, hexavalent chromium, polybrominated biphenyls (PBB) and polybrominated diphenyl ethers (PBDE)

2) Content of six substances specified in Management Methods for Control of Pollution Caused by Electronic Information Products Regulation (Chinese : 电子信息产品污染控制管理办法).

Category	Toxic and hazardous substances					
	Lead (Pb)	Mercury (Hg)	Cadmium (Cd)	Hexavalent chromium (Cr ⁶⁺)	Polybrominated biphenyls (PBB)	Polybrominated diphenyl ethers (PBDE)
Photointerrupter	✓	✓	✓	✓	✓	✓

✓ : indicates that the content of the toxic and hazardous substance in all the homogeneous materials of the part is below the concentration limit requirement as described in SJ/T 11363-2006 standard.

● Product mass : Approx. 5mg

● Country of origin : China

● Taping specification : Refer to the attachment-2.

● Moisture-proof package specification : Refer to the attachment-3.

■Notes

●Circuit design

In circuit designing, make allowance for the degradation of the light emitting diode output that results from long continuous operation. (50% degradation/5 years)

●Prevention of detection error

To prevent photointerrupter from faulty operation caused by external light, do not set the detecting face to the external light.

●Position of opaque board

Opaque board shall be installed at place 0.86mm or more from the top of elements.

(Example)

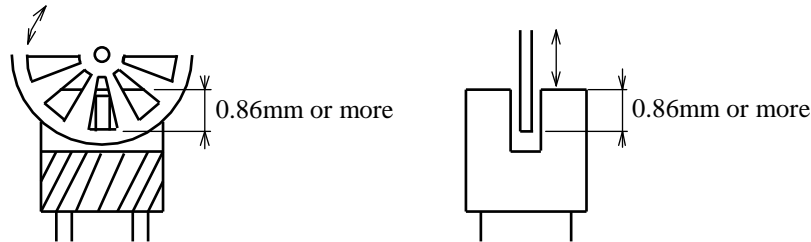

●Soldering

1) Reflow soldering

Please do only two soldering at the temperature and the time within the temperature profile in attachment-1.

2) Hand soldering

To solder onto lead pins, please solder at 300°C for 3 seconds or less.

Please also take care not to let mechanical stress exert on package and lead pins when soldering.

Please have soldering adjustment, etc. after GP1S396HCPSF is cooled down, and also note that the outer mold resin may be meltdown by heating for a long time.

Since the tip of the lead has exposed lead frame base material, there is a case not to be soldered, so please consider the soldering pattern on a print circuit board to solder well with the bottom and side surface of the lead.

●Cleaning

Cleaning shall be carried out under the below conditions to avoid keeping solvent, solder and flux on the device.

1) Solvent cleaning : Solvent temperature 45°C or less, Immersion for 3 min. or less

2) Ultrasonic cleaning : Since the influence to the product may changes by the conditions of the ultrasonic power, time, the tank size, PCB size, the product installation condition, etc., please evaluate with actual conditions and confirm before usage.

3) The cleaning shall be carried out with solvent below.

Solvent : Ethyl alcohol, Methyl alcohol

●Lead pin

Lead terminals of this product have Copper, Nickel, Palladium and Gold plating.

Before usage, please evaluate solder ability with actual conditions and confirm.

The uniformity in color for the lead terminals are not specified.

●Storage and management after open

1) Storage condition : Storage shall be in accordance with the below conditions.

Storage temp. : 5 to 30°C

Storage humidity : 70%RH or less

2) Treatment after open

(1) After open, please mount at the conditions of humidity 60%RH or less and temperature 5 to 30°C within 3 days.

In case that two times reflow soldering are required, please complete your 2nd reflow soldering within 3 days after the 1st reflow soldering.

(2) In case of long time storage after open, please storage at the conditions of humidity 70%RH or less and temperature 5 to 30°C by using dry box or resealing with desiccant in moisture-proof bag by sealer and mount within 2 weeks.

3) Baking before mounting

In case that it could not carry out the above treatment, it is able to mount with baking treatment.

However baking treatment shall be limited only 1 time. Although it is possible to have baking treatment with taping package, please bake it by putting a reel with standing situation. Please do not lay it down since it may change the reel shape and occur a mounting problem. Since a label and a fixing tape for the carrier tape does not have enough heat resistance, there may be a case to leave some paste.

Recommended baking conditions : 100°C, 22 to 26 hours

■Parts

This product uses the below parts.

- Light detector (Quantity : 1)

Type	Material	Maximum sensitivity (nm)	Sensitivity (nm)	Response time (μs)
Phototransistor	Silicon (Si)	920	700 to 1200	20

- Light emitter (Quantity : 1)

Type	Material	Maximum light emitting wavelength (nm)	I/O Frequency (MHz)
Infrared light emitting diode (non-coherent)	GaAs	940	0.3

- Material

Case	Lead frame	Lead frame plating
Black PPA resin	42 Alloy	Au-Pd-Ni-Cu

- Others

This product shall not be proof against radiation flux.

■ **Packing**

Drawing No. CY14943i09

● Inner Packing

1) Inner Packaging drawing

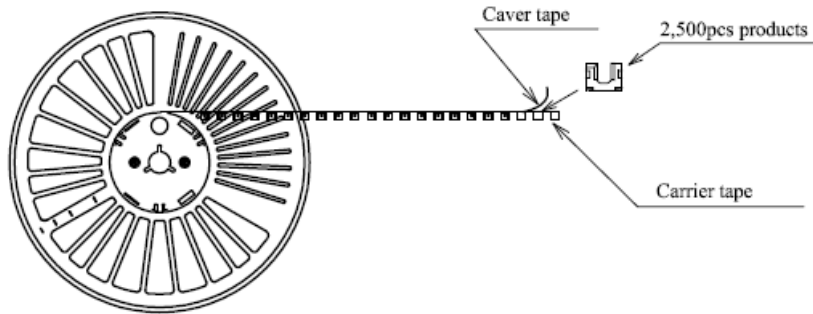

2) Inner Packing material : • Reel(PPE) • Carrier tape(PC) • Caver tape(PET)

3) Quantity : 2,500pcs./Reel

● Outer Packaging

1) Outer Packaging drawing

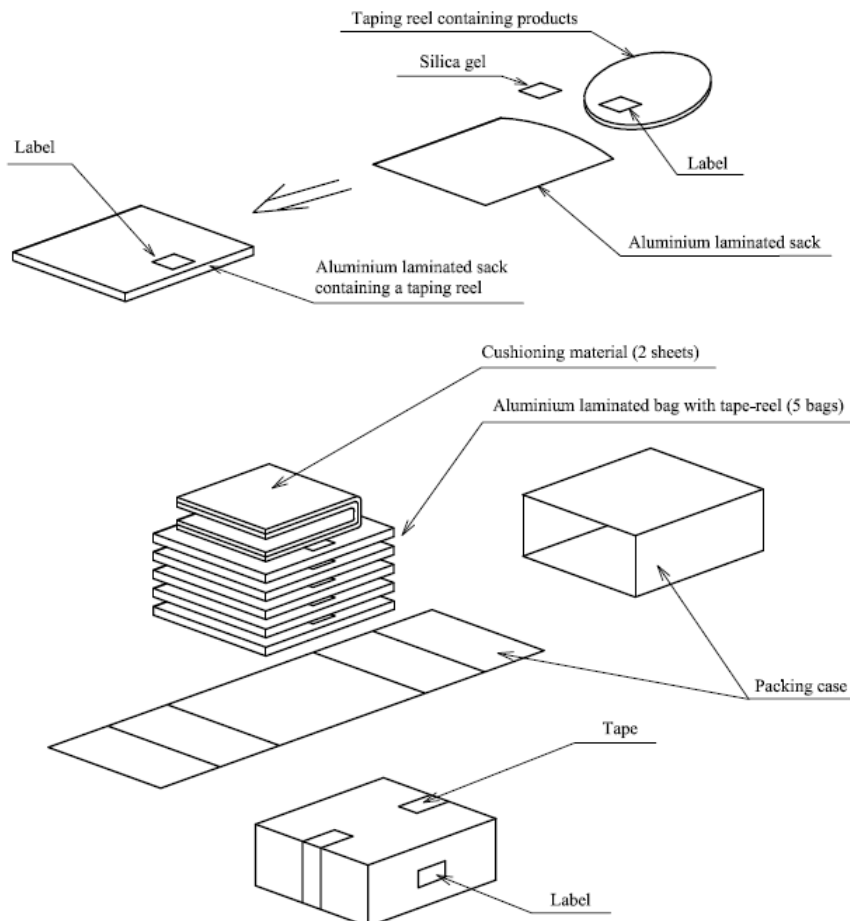

2) Outer Packing material : Packing case(Corrugated cardboard), Cushioning material(Urethane)
Aluminium laminated bag(Alumi-Polyethylene)
Label(paper), silica gel, craft tape

3) Quantity : 12,500pcs./box

4) The contents of the carton indication conforms to EIAJ C-3 and the following items are indicated.

Model No., Internal production control name, Quantity, Packing date, Corporate name, Country of origin

5) Regular packaged mass : Approximately 700g

(Attachment-1)

Precautions for Soldering photointerrupter

1) In case of reflow soldering,

Please do only two soldering at the temperature and the time within the temperature profile as shown in the figure below.

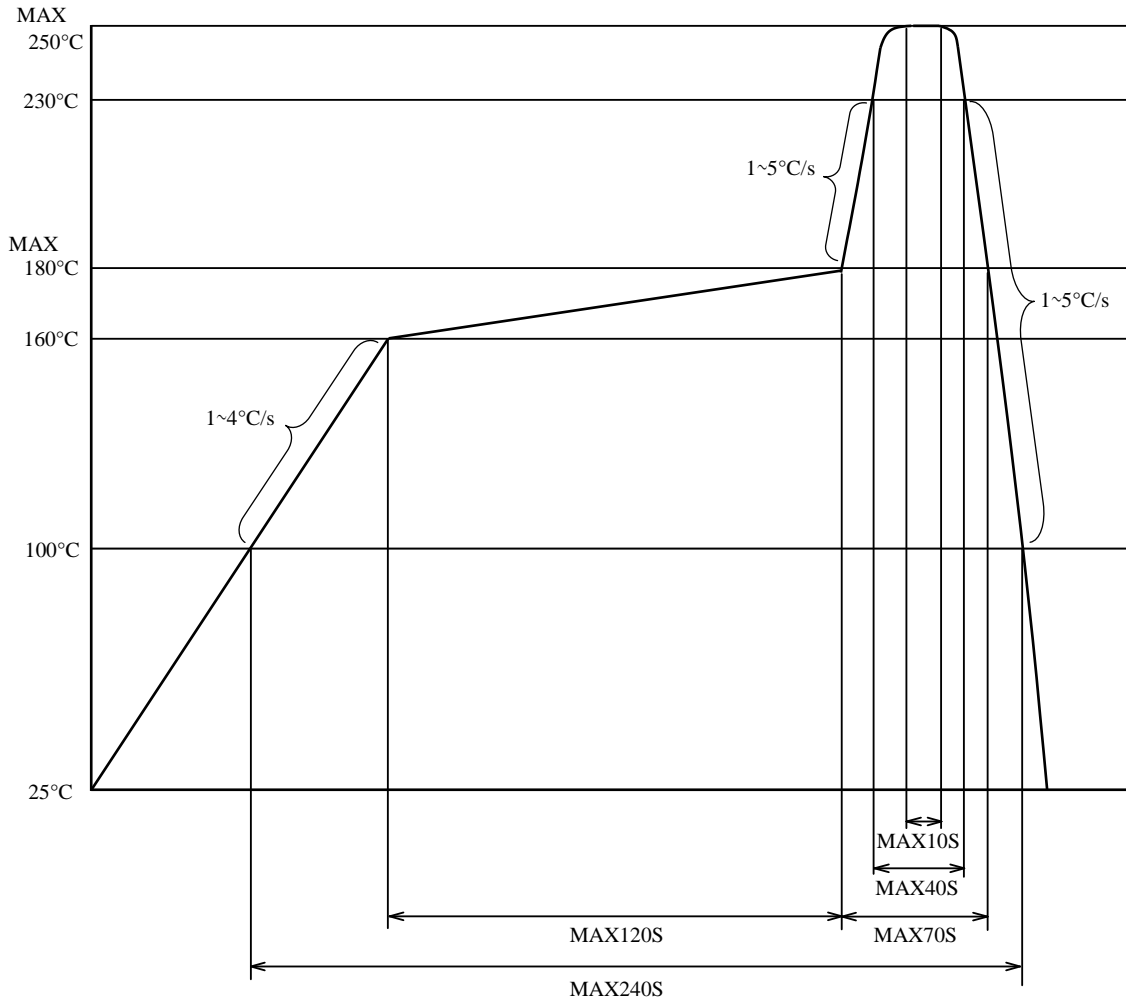

2) Other precautions

An infrared lamp used to heat up for soldering may cause a localized temperature rise in the resin.

So keep the package temperature within that specified in Item 1.

Also avoid immersing the resin part in the solder.

Even if within the temperature profile above, there is the possibility that the gold wire in package is broken in case that the deformation of PCB gives the affection to lead pins.

Please use after confirmation the conditions fully by actual solder reflow machine.

(Attachment-2-1)

Package specifications (φ180mm reel)

1) Application

This specification applies to the taping specifications and the relation items for the GP1S396HCPSF.

2) Taping method

(1) Tape structure and Dimensions (Refer to the attached sheets-2-2)

The tape shall have a structure in which a cover tape is sealed pressed on the carrier tape made by polycarbonate to protect against static electricity.

(2) Reel structure and Dimensions (Refer to the attached sheets-2-3)

(3) Direction of product insertion (Refer to the attached sheets-2-3)

Product direction in carrier tape shall direct to the detector at the hole side on the tape.

3) Repair method of sealing error

In case of repairing a sealing error, three sides of a cover tape matching to the product insertion portion are opened by a cutter and it will be closed by adhesiveness tape after repairing.

4) Adhesiveness of cover tape

The exhalation force between carrier tape and cover tape shall be 0.1N to 1.0N for the angle from 165° to 180°.

5) Rolling method and quantity

(1) Wind the tape back on the reel so that the cover tape will be outside the tape.

(2) Attach more than 16cm of blank tape to the trailer and attach more than 10cm of the leader.

Attach more than 40cm of cover tape to the leader to the tape and fix the both ends with adhesive tape.

(3) One reel shall contain 2,500 pcs.

6) Indication items

The contents of the carton indication conforms to EIAJ C-3 and the following items are indicated.

Model No., Internal production control name, Quantity, Packing date, Corporate name, Country of origin

7) Safety protection during shipping

There shall be no deformation of component or degradation of electrical characteristics due to shipping.

(Attachment-2-2)

- Tape structure and dimensions

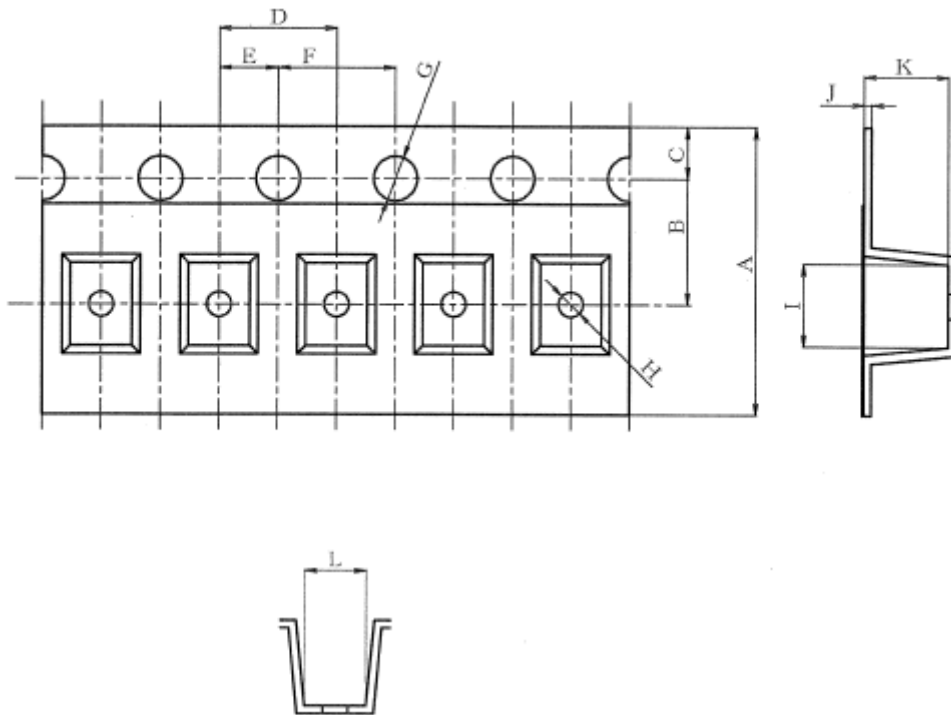

Symbol	Dimensions					
Unit	A	B	C	D	E	F
mm	8.0 ±0.3	3.5 ±0.1	1.75 ±0.1	4.0 ±0.1	2.0 ±0.1	4.0 ±0.1

Symbol	Dimensions					
Unit	G	H	I	J	K	L
mm	φ 1.5 ^{+0.1} ₋₀	φ 1.0 ±0.2	2.43 ±0.1	0.28 ±0.05	1.76 ±0.1	1.56 ±0.1

(Attachment-2-3)

- Reel structure and dimensions

Details for reel fixing hole

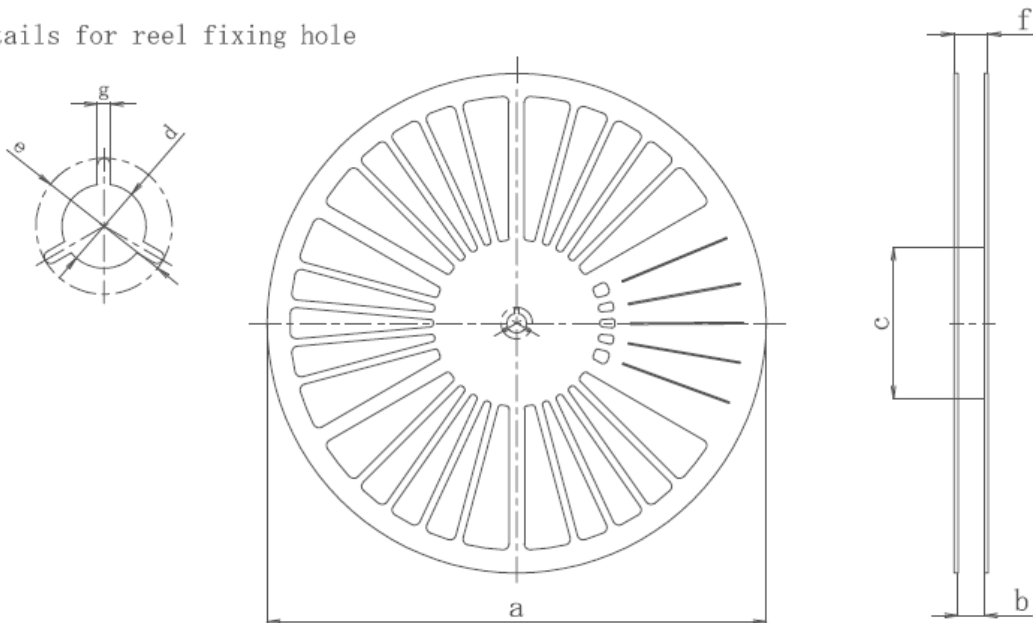

Symbol	Dimensions						
Unit	a	b	c	d	e	f	g
mm	$\phi 180 \pm 2.0$	9.5 ± 1.0	$\phi 60 \pm 1.0$	$\phi 13 \pm 0.2$	21 ± 0.8	13.1 ± 1.0	2 ± 0.5

- Direction of product insertion

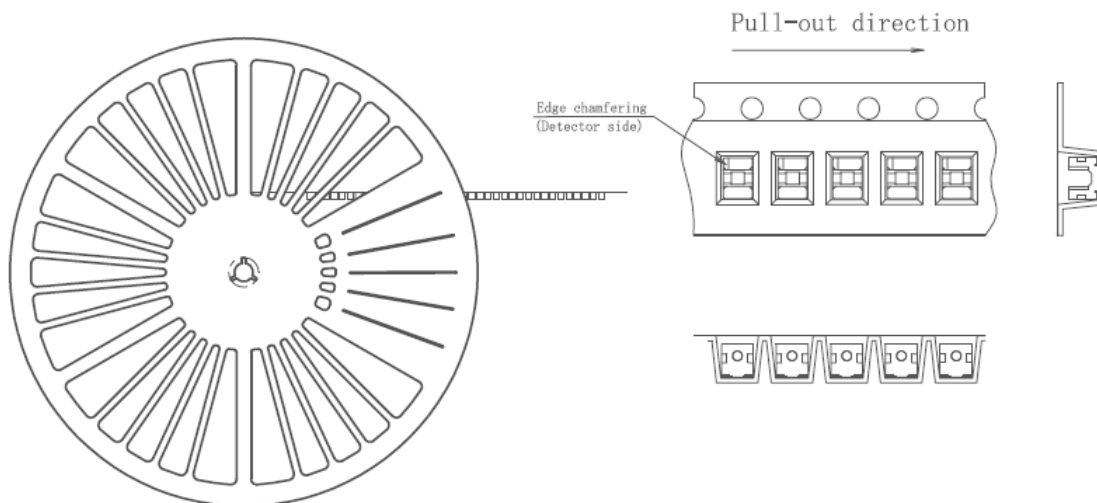

(Attachment-3-1)

Moisture-proof package specification

1) Application

This specification applies to the moisture-proof package for the GP1S396HCPSF.

2) Packaging specifications

(1) Packaging material

Name	Material
Aluminum laminated sack	Aluminum polyethylene
Label	Paper(-made)
Silica gel	-
Outer case	Paper(-made)
Cushioning material	Urethane

(2) Packaging method

- ① Seal a reel with 2,500pcs products into an aluminum laminated bag included the ruled silica gel quantity.
- ② Fill up the blank of label and paste on the bag.
- ③ Put the moisture-proof laminated bag in the ruled case (5bag/case).

The cushioning material is put in case.

Package shape	Product	Quantity	Moisture-proof sack Quantity
Tape-reel (φ180mm)	Single	2,500pcs./reel	1reel/bag

Minimum order Quantity : 2,500pcs (1 reel/bag)

- ④ Fill out the model name, quantity and date after closing the outer case by craft tape.
(Quantity: 12,500pcs./case) *Except the case products by failing to seal are cut out

3) Storage and management after open

- (1) Storage condition : Storage shall be in accordance with the below conditions.

Storage temp. : 5 to 30°C

Storage humidity : 70%RH or less

- (2) Treatment after open

- ① After open, please mount at the conditions of humidity 60%RH or less and temperature 5 to 30°C within 3 days.

In case that two times reflow soldering are required, please complete your 2nd reflow soldering within 3 days after the 1st reflow soldering.

- ② In case of long time storage after open, please storage at the conditions of humidity 70%RH or less and temperature 5 to 30°C by using dry box or resealing with desiccant in moisture-proof bag by sealer and mount within 2 weeks.

- (3) Baking before mounting

In case that it could not carry out the above treatment, it is able to mount with baking treatment.

However baking treatment shall be limited only 1 time.

Although it is possible to have baking treatment with taping package, please bake it by putting a reel with standing situation.

Please do not lay it down since it may change the reel shape and occur a mounting problem.

Since a label and a fixing tape for the carrier tape does not have enough heat resistance, there may be a case to leave some paste.

Recommended baking conditions : 100°C, 22 to 26 hours

(Attachment-3-2)

- Baking treatment before mounting
 - Placement of reels in an oven

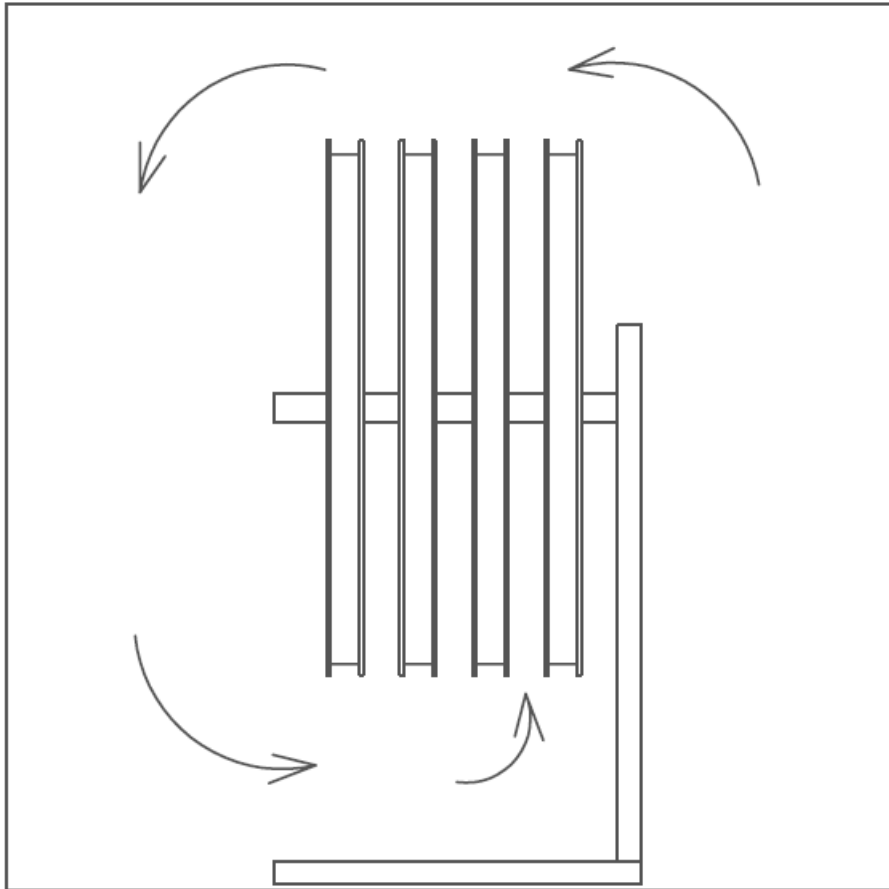

- 1) Please hang reels by using a center hole for fixing the reel.
Please keep some space between reels for better air rotation in the oven.
Please do not lay a reel down in the oven to avoid any damages for the tape edge and the flange of reel.
- 2) Please make sure the carrier tape does not have any slack in a reel before baking to avoid peeling the cover tape off.
Since the tape using for fixing carrier tape is not heatproof, there is a case to remain glue.
So if necessary, please change the tape to a heatproof one.

■ Important Notices

· The circuit application examples in this publication are provided to explain representative applications of SHARP devices and are not intended to guarantee any circuit design or license any intellectual property rights. SHARP takes no responsibility for any problems related to any intellectual property right of a third party resulting from the use of SHARP's devices.

· Contact SHARP in order to obtain the latest device specification sheets before using any SHARP device. SHARP reserves the right to make changes in the specifications, characteristics, data, materials, structure, and other contents described herein at any time without notice in order to improve design or reliability. Manufacturing locations are also subject to change without notice.

· Observe the following points when using any devices in this publication. SHARP takes no responsibility for damage caused by improper use of the devices which does not meet the conditions and absolute maximum ratings to be used specified in the relevant specification sheet nor meet the following conditions:

(i) The devices in this publication are designed for use in general electronic equipment designs such as:

- Personal computers
- Office automation equipment
- Telecommunication equipment [terminal]
- Test and measurement equipment
- Industrial control
- Audio visual equipment
- Consumer electronics

(ii) Measures such as fail-safe function and redundant design should be taken to ensure reliability and safety when SHARP devices are used for or in connection

with equipment that requires higher reliability such as:

- Transportation control and safety equipment (i.e., aircraft, trains, automobiles, etc.)
- Traffic signals
- Gas leakage sensor breakers
- Alarm equipment
- Various safety devices, etc.

(iii) SHARP devices shall not be used for or in connection with equipment that requires an extremely high level of reliability and safety such as:

- Space applications
- Telecommunication equipment [trunk lines]
- Nuclear power control equipment
- Medical and other life support equipment (e.g., scuba).

· If the SHARP devices listed in this publication fall within the scope of strategic products described in the Foreign Exchange and Foreign Trade Law of Japan, it is necessary to obtain approval to export such SHARP devices.

· This publication is the proprietary product of SHARP and is copyrighted, with all rights reserved. Under the copyright laws, no part of this publication may be reproduced or transmitted in any form or by any means, electronic or mechanical, for any purpose, in whole or in part, without the express written permission of SHARP. Express written permission is also required before any use of this publication may be made by a third party.

· Contact and consult with a SHARP representative if there are any questions about the contents of this publication.

Компания «Океан Электроники» предлагает заключение долгосрочных отношений при поставках импортных электронных компонентов на взаимовыгодных условиях!

Наши преимущества:

- Поставка оригинальных импортных электронных компонентов напрямую с производств Америки, Европы и Азии, а так же с крупнейших складов мира;
- Широкая линейка поставок активных и пассивных импортных электронных компонентов (более 30 млн. наименований);
- Поставка сложных, дефицитных, либо снятых с производства позиций;
- Оперативные сроки поставки под заказ (от 5 рабочих дней);
- Экспресс доставка в любую точку России;
- Помощь Конструкторского Отдела и консультации квалифицированных инженеров;
- Техническая поддержка проекта, помощь в подборе аналогов, поставка прототипов;
- Поставка электронных компонентов под контролем ВП;
- Система менеджмента качества сертифицирована по Международному стандарту ISO 9001;
- При необходимости вся продукция военного и аэрокосмического назначения проходит испытания и сертификацию в лаборатории (по согласованию с заказчиком);
- Поставка специализированных компонентов военного и аэрокосмического уровня качества (Xilinx, Altera, Analog Devices, Intersil, Interpoint, Microsemi, Actel, Aeroflex, Peregrine, VPT, Syfer, Eurofarad, Texas Instruments, MS Kennedy, Miteq, Cobham, E2V, MA-COM, Hittite, Mini-Circuits, General Dynamics и др.);

Компания «Океан Электроники» является официальным дистрибьютором и эксклюзивным представителем в России одного из крупнейших производителей разъемов военного и аэрокосмического назначения «**JONHON**», а так же официальным дистрибьютором и эксклюзивным представителем в России производителя высокотехнологичных и надежных решений для передачи СВЧ сигналов «**FORSTAR**».



JONHON

«**JONHON**» (основан в 1970 г.)

Разъемы специального, военного и аэрокосмического назначения:

(Применяются в военной, авиационной, аэрокосмической, морской, железнодорожной, горно- и нефтедобывающей отраслях промышленности)

«**FORSTAR**» (основан в 1998 г.)

ВЧ соединители, коаксиальные кабели,
кабельные сборки и микроволновые компоненты:

(Применяются в телекоммуникациях гражданского и специального назначения, в средствах связи, РЛС, а так же военной, авиационной и аэрокосмической отраслях промышленности).



Телефон: 8 (812) 309-75-97 (многоканальный)

Факс: 8 (812) 320-03-32

Электронная почта: ocean@oceanchips.ru

Web: <http://oceanchips.ru/>

Адрес: 198099, г. Санкт-Петербург, ул. Калинина, д. 2, корп. 4, лит. А