

DELPHI SERIES



FEATURES

- ◆ High efficiency: 93.2% @ 12V/ 25A
- ◆ Standard footprint: 58.4 x 61.0 x 11.2 mm (2.30" x2.40"x0.44")
- ◆ Industry standard pin out
- ◆ Single board construction
- ◆ Fixed frequency operation
- ◆ 2250V Isolation
- ◆ Basic insulation
- ◆ Monotonic startup into normal and pre-bias loads
- ◆ Fully protected: input UVLO, output OVP, OCP, OTP
- ◆ No minimum load required
- ◆ Wide output trim range: -20%, +10%
- ◆ ISO 9001, TL 9000, ISO 14001, QS 9000, OHSAS 18001 certified manufacturing facility
- ◆ UL/cUL 60950-1 (US & Canada) Recognized, and TUV (EN60950-1) Certified
- ◆ CE mark meets 73/23/EEC and 93/68/EEC directives

Delphi Series H48SA, Half Brick Family DC/DC Power Modules: 48V in, 12V/25A out

The Delphi Series H48SA Half Brick, 48V input, single output, isolated, open frame DC/DC converters are the latest offering from a world leader in power systems technology and manufacturing — Delta Electronics, Inc. This product family provides up to 300 watts of power or up to 25A of output current in an industry standard footprint. This product represents the next generation of design technology required by today's leading-edge circuitry. With creative design technology and optimization of component placement, these converters possess outstanding electrical and thermal performance, as well as extremely high reliability under highly stressful operating conditions. Typical efficiency of the 12V, 300W module is better than 93.2% and all modules are fully protected from abnormal input/output voltage, current and temperature conditions. The Delphi Series converters meet all safety requirements with basic insulation. A variety of optional heatsinks are available for extended thermal operation.

OPTIONS

- ◆ Positive on/off
- ◆ Heatspreader available for extended operation

APPLICATIONS

- ◆ Telecom / DataCom
- ◆ Wireless Networks
- ◆ Optical Network Equipment
- ◆ Server and Data Storage
- ◆ Industrial / Test Equipment

TECHNICAL SPECIFICATIONS

($T_A=25^{\circ}\text{C}$, airflow rate=300 LFM, $V_{in}=48\text{Vdc}$, nominal V_{out} unless otherwise noted.)

PARAMETER	NOTES and CONDITIONS	H48SA12025 (Standard)			
		Min.	Typ.	Max.	Units
ABSOLUTE MAXIMUM RATINGS					
Input Voltage					
Continuous				80	Vdc
Transient (100ms)	100ms			100	Vdc
Operating Device Temperature(Openframe)	Please refer to fig24. for the measuring point	-40		122	$^{\circ}\text{C}$
Operating Device Temperature(Heatspreader)	Please refer to fig25. for the measuring point	-40		109	$^{\circ}\text{C}$
Storage Temperature		-55		125	$^{\circ}\text{C}$
Input/Output Isolation Voltage				2250	Vdc
INPUT CHARACTERISTICS					
Operating Input Voltage		36	48	75	Vdc
Input Under-Voltage Lockout					
Turn-On Voltage Threshold		32.5	34	35.5	Vdc
Turn-Off Voltage Threshold		30.5	32	33.5	Vdc
Lockout Hysteresis Voltage		1	2	3	Vdc
Maximum Input Current	$V_{in}=36\text{V}$, 100% Load			9.5	A
No-Load Input Current			170	240	mA
Off Converter Input Current				18	mA
Inrush Current(I^2t)	With 100uF external input cap			1	A ² S
Input Terminal Ripple Current	RMS, With 100uF/0.1ohm input cap, 100% Load			0.42	A
Input Reflected-Ripple Current	Pk-Pk, thru 12uH inductor, 5Hz to 20MHz, 100% Load		7		mA
Input Voltage Ripple Rejection	120 Hz		50		dB
OUTPUT CHARACTERISTICS					
Output Voltage Set Point	$V_{in}=48\text{V}$, $I_o=I_{o,max}$, $T_c=25^{\circ}\text{C}$	11.82	12	12.18	Vdc
Output Voltage Regulation					
Over Load	$I_o=I_{o,min}$ to $I_{o,max}$		± 10		mV
Over Line	$V_{in}=36\text{V}$ to 75V		± 10		mV
Over Temperature	$T_c=-40^{\circ}\text{C}$ to 100°C		± 120		mV
Total Output Voltage Range	over sample load, line and temperature	11.64		12.36	V
Output Voltage Ripple and Noise	5Hz to 20MHz bandwidth				
Peak-to-Peak	100% Load, 1uF ceramic, 10uF tantalum		60	120	mV
RMS	100% Load, 1uF ceramic, 10uF tantalum		30	60	mV
Operating Output Current Range	Full input range	0		25	A
Operating Output Power Range	Full input range	0		300	W
Output DC Current Protection	Full input range	110		150	%
DYNAMIC CHARACTERISTICS					
Output Voltage Current Transient	48V, 10uF Tan & 1uF Ceramic load cap, 0.1A/us				
Positive Step Change in Output Current	50% $I_{o,max}$ to 75% $I_{o,max}$		400		mV
Negative Step Change in Output Current	75% $I_{o,max}$ to 50% $I_{o,max}$		400		mV
Settling Time (within 1% V_{out} nominal)			400		uS
Turn-On Transient					
Start-Up Time, From On/Off Control		12		28	mS
Start-Up Time, From Input		12		28	mS
Maximum Output Capacitance	100% Resistor load; 5% overshoot of V_{out} at startup			10000	uF
EFFICIENCY					
100% Load	$V_{in}=48\text{V}$		93.2		%
60% Load	$V_{in}=48\text{V}$		92.5		%
ISOLATION CHARACTERISTICS					
Input to Output				2250	Vdc
Isolation Resistance		10			M Ω
Isolation Capacitance			1500		pF
FEATURE CHARACTERISTICS					
Switching Frequency			300		kHz
ON/OFF Control, Negative Remote On/Off logic					
Logic Low (Module On)	$V_{on/off}$	-2		1.2	V
Logic High (Module Off)	$V_{on/off}$	3		18	V
ON/OFF Control, Positive Remote On/Off logic					
Logic Low (Module Off)	$V_{on/off}$	-2		1.2	V
Logic High (Module On)	$V_{on/off}$	3		18	V
ON/OFF Current (for both remote on/off logic)	$I_{on/off}$ at $V_{on/off}=0.0\text{V}$			0.3	mA
ON/OFF Current (for both remote on/off logic)	$I_{on/off}$ at $V_{on/off}=3\text{V}$	10			uA
Leakage Current(for both remote on/off logic)	Logic High, $V_{on/off}=15\text{V}$			100	uA
Output Voltage Trim Range	$P_{out} \leq \text{max rated power}$	9.6		13.2	V
Output Voltage Remote Sense Range	$P_{out} \leq \text{max rated power}$			10	%
Output Over-Voltage Protection	Over full input range; Over full temp range	115		140	%
GENERAL SPECIFICATIONS					
MTBF	$I_o=80\%$ of $I_{o,max}$; $T_a=25^{\circ}\text{C}$, airflow rate=300 LFM		1.5		M hours
Weight	Open frame		80		grams
Over-Temperature Shutdown(Openframe)	Please refer to Fig 24. for the measuring point		127		$^{\circ}\text{C}$
Over-Temperature Shutdown(Heatspreader)	Please refer to Fig 25. for the measuring point		116		$^{\circ}\text{C}$



ELECTRICAL CHARACTERISTICS CURVES

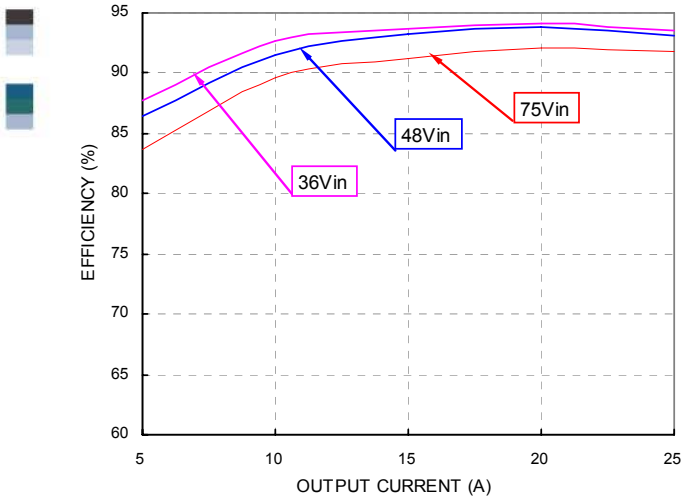

Figure 1: Efficiency vs. load current for minimum, nominal, and maximum input voltage at 25°C. $V_{out}=12V$.

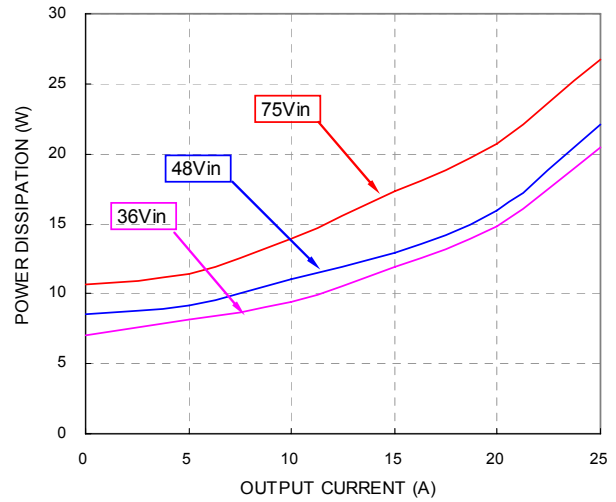

Figure 2: Power dissipation vs. load current for minimum, nominal, and maximum input voltage at 25°C. $V_{out}=12V$.

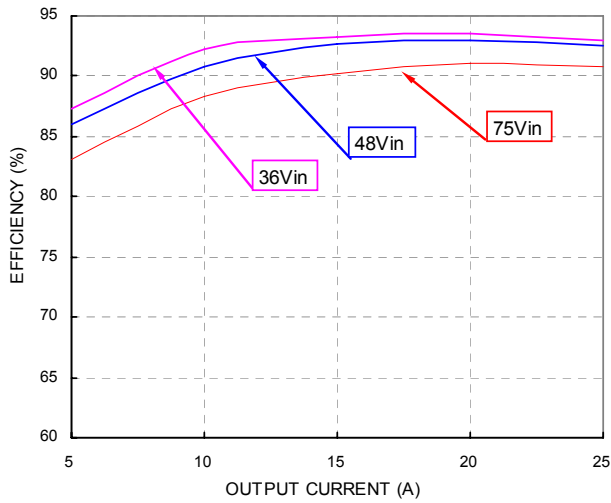

Figure 3: Efficiency vs. load current for minimum, nominal, and maximum input voltage at 25°C. $V_{out}=9.6V$.

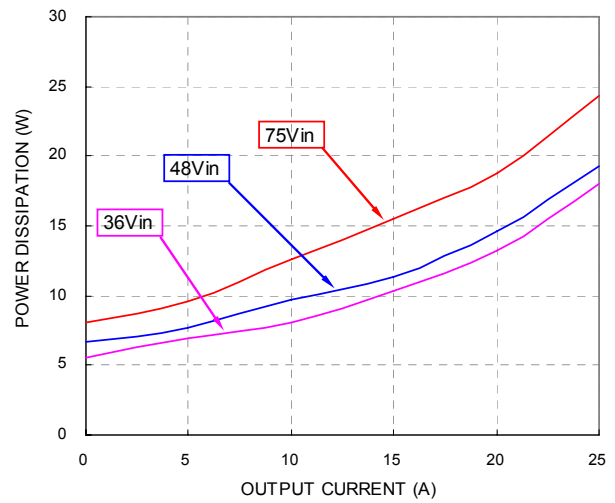
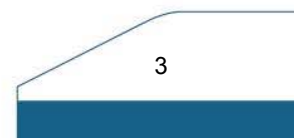

Figure 4: Power dissipation vs. load current for minimum, nominal, and maximum input voltage at 25°C. $V_{out}=9.6V$.





ELECTRICAL CHARACTERISTICS CURVES

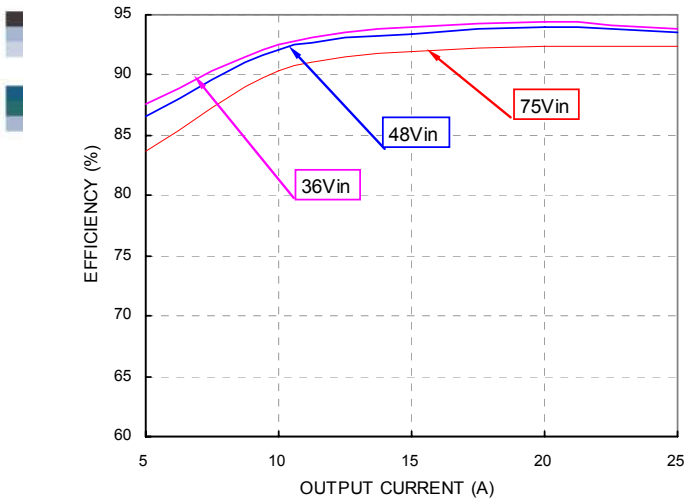

Figure 5: Efficiency vs. output voltage for minimum, nominal, and maximum input voltage at 25°C, $V_{out}=13.2V$.

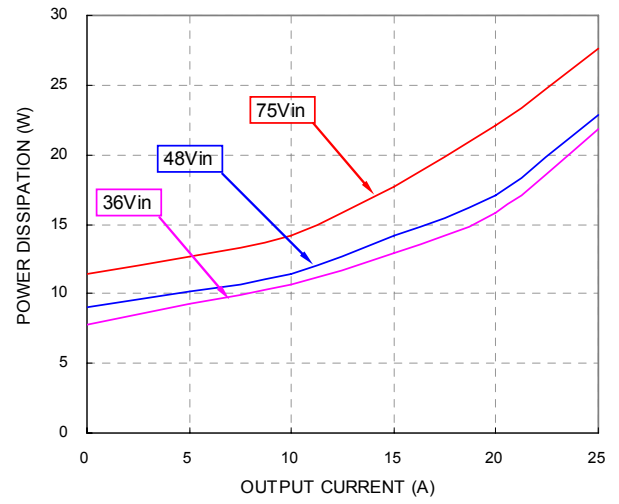

Figure 6: Power dissipation vs. output voltage for minimum, nominal, and maximum input voltage at 25°C, $V_{out}=13.2V$.

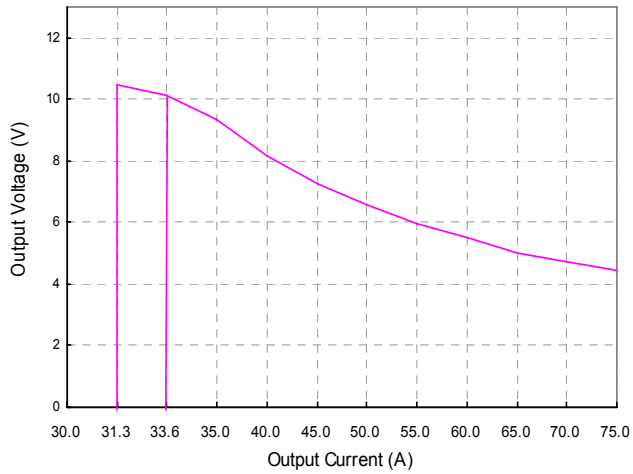

Figure 7: Typical input characteristics at room temperature.

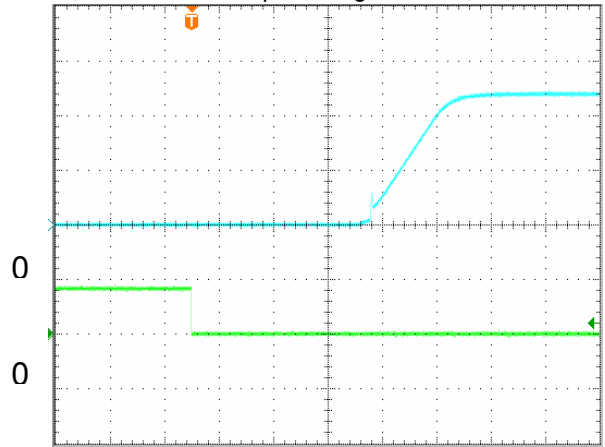
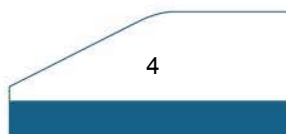

Figure 8: Turn-on transient at full rated load current, 4ms/div: Top Trace: V_{out} , 5V/div; Bottom Trace: ON/OFF input, 5V/div.





ELECTRICAL CHARACTERISTICS CURVES

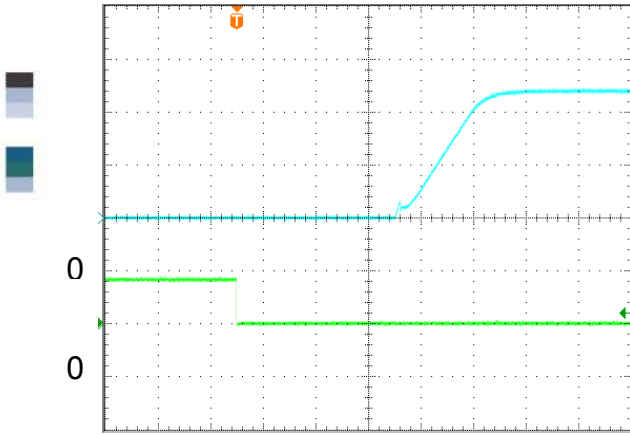

Figure 9: Turn-on transient at zero load current, 4 ms/div; Top Trace: Vout, 5V/div; Bottom Trace: ON/OFF input, 5V/div.

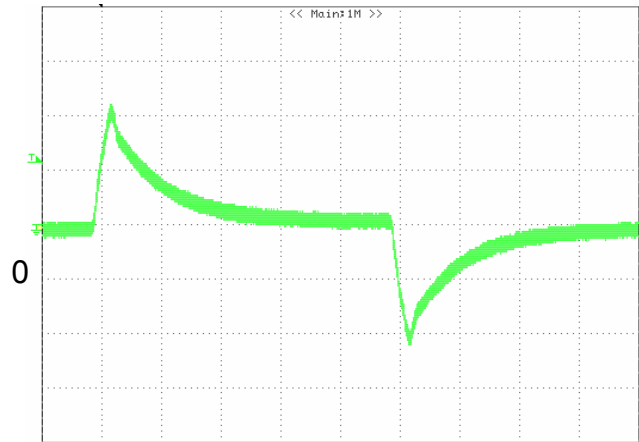

Figure 10: Output voltage response to step-change in load current, 200mV/div, 200us/div. 75%-50%-75% of I_o , max, $di/dt = 0.1A/\mu s$. Load cap: 10 μF , tantalum capacitor and 1 μF ceramic capacitor.

Scope measurement should be made using a BNC cable (length shorter than 20 inches). Position the load between 51 mm to 76 mm (2 inches to 3 inches) from the module..

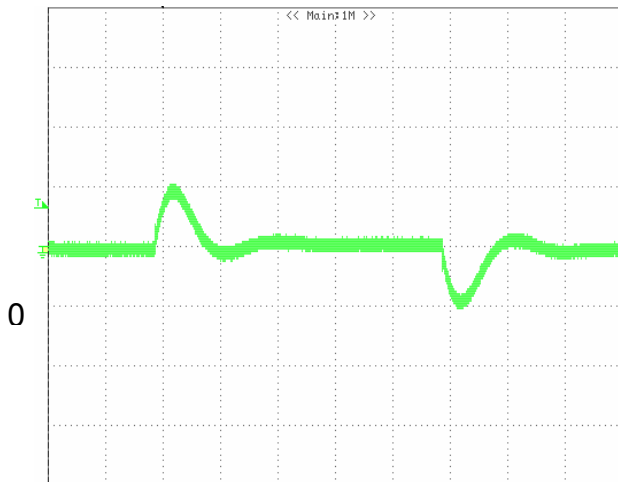

Figure 11: Output voltage response to step-change in load current, 200mV/div, 1ms/div. 75%-50%-75% of I_o , max, $di/dt = 1A/\mu s$. Load cap: 5000 μF tantalum capacitor and 1 μF ceramic capacitor.

Scope measurement should be made using a BNC cable (length shorter than 20 inches). Position the load between 51 mm to 76 mm (2 inches to 3 inches) from the module..

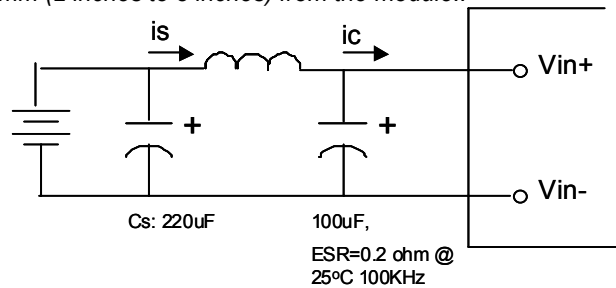

Figure 12: Test set-up diagram showing measurement points for Input Terminal Ripple Current and Input Reflected Ripple Current. Note: Measured input reflected-ripple current with a simulated source Inductance (L_{TEST}) of 12 μH . Capacitor C_s offset possible battery impedance. Measured current as shown below.



ELECTRICAL CHARACTERISTICS CURVES

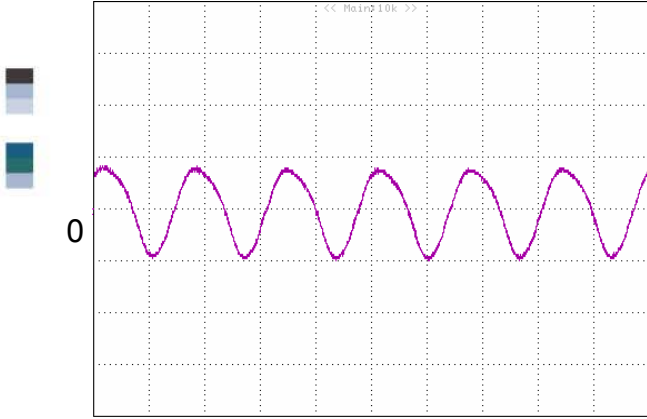

Figure 13: Input Terminal Ripple Current, i_c , at nominal input voltage and rated load current with $12\mu\text{H}$ source impedance and $100\mu\text{F}$ electrolytic capacitor, 500 mA/div, 2us/div.

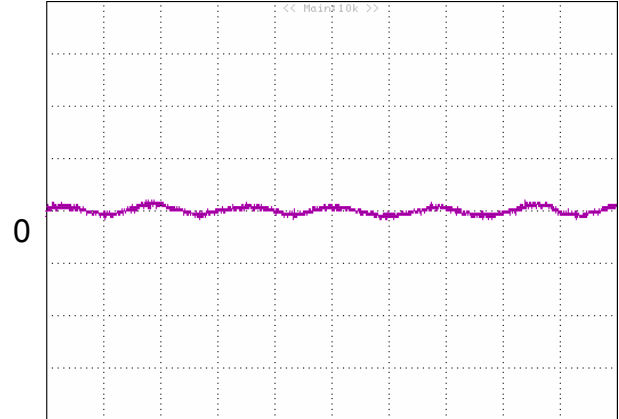

Figure 14: Input reflected ripple current, i_s , through a $12\mu\text{H}$ source inductor at nominal input voltage and rated load current, 20 mA/div, 2us/div.

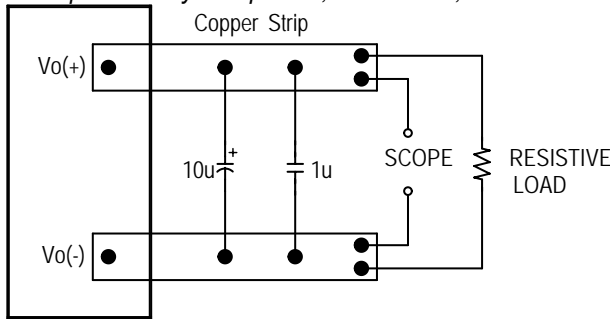

Figure 15: Output voltage noise and ripple measurement test setup

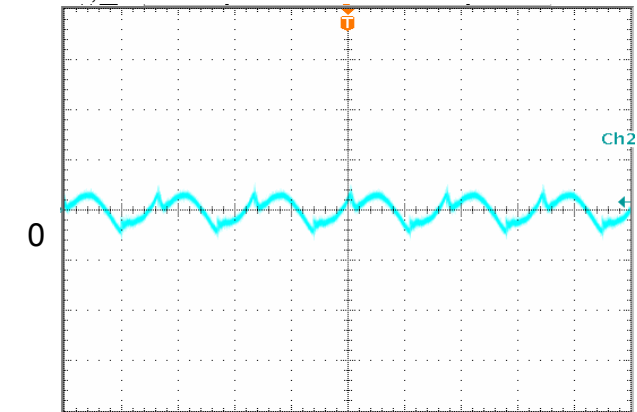

Figure 16: Output voltage ripple at nominal input voltage and rated load current, 50mV/div, 2us/div. Load capacitance: $1\mu\text{F}$ ceramic capacitor and $10\mu\text{F}$ tantalum capacitor. Bandwidth: 20 MHz. Scope measurement should be made using a BNC cable (length shorter than 20 inches). Position the load between 51 mm to 76 mm (2 inches to 3 inches) from the module.

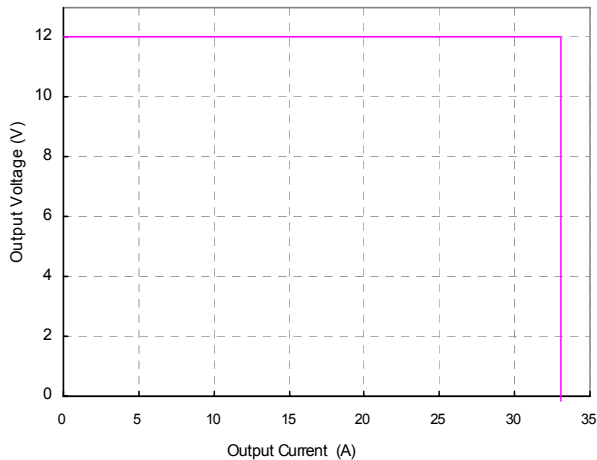

Figure 17: Output voltage vs. load current showing typical current limit curves and converter shutdown points.



DESIGN CONSIDERATIONS

Input Source Impedance

The impedance of the input source connecting to the DC/DC power modules will interact with the modules and affect the stability. A low ac-impedance input source is recommended. If the source inductance is more than a few μH , we advise adding a 33 to 100 μF electrolytic capacitor (ESR < 0.7 Ω at 100 kHz) mounted close to the input of the module to improve the stability.

Layout and EMC Considerations

Delta's DC/DC power modules are designed to operate in a wide variety of systems and applications. For design assistance with EMC compliance and related PWB layout issues, please contact Delta's technical support team. An external input filter module is available for easier EMC compliance design. Below is the reference design for an input filter tested with H48SA12025NN A to meet class B in CISPR 22.

Schematic and Components List

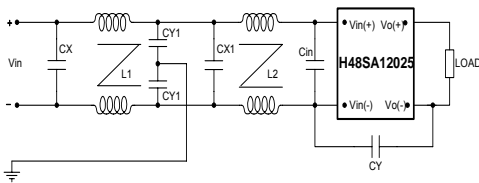

- CX is 4.7 μF ceramic cap;
- CX1 is 4.7 μF ceramic cap;
- CY is 3.3nF ceramic cap;
- CY1 is 4.7nF ceramic cap;
- L1 is common-mode inductor, L1=0.08mH;
- L2 is common-mode inductor, L1=0.24mH;

Test Result

Test result is in compliance with CISPR 22 class B, which is shown as below:

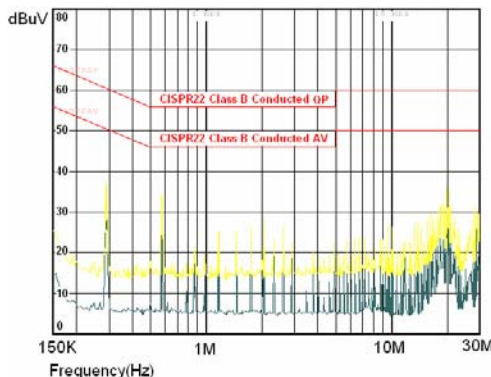

Vin=48V, Io=25A,
Yellow line is quasi peak mode;
Blue line is average mode.

Safety Considerations

The power module must be installed in compliance with the spacing and separation requirements of the end-user's safety agency standard, i.e., UL60950, CAN/CSA-C22.2 No. 60950-00 and EN60950:2000 and IEC60950-1999, if the system in which the power module is to be used must meet safety agency requirements. When the input source is 60 Vdc or below, the power module meets SELV (safety extra-low voltage) requirements. If the input source is a hazardous voltage which is greater than 60 Vdc and less than or equal to 75 Vdc, for the module's output to meet SELV requirements, all of the following must be met:

- The input source must be insulated from any hazardous voltages, including the ac mains, with reinforced insulation.
- One Vi pin and one Vo pin are grounded, or all the input and output pins are kept floating.
- The input terminals of the module are not operator accessible.
- If the metal baseplate is grounded the output must be also grounded.
- A SELV reliability test is conducted on the system where the module is used to ensure that under a single fault, hazardous voltage does not appear at the module's output.

Do not ground one of the input pins without grounding one of the output pins. This connection may allow a non-SELV voltage to appear between the output pin and ground. The power module has extra-low voltage (ELV) outputs when all inputs are ELV. This power module is not internally fused. To achieve optimum safety and system protection, an input line fuse is highly recommended. The safety agencies require a fuse with 30A maximum rating to be installed in the ungrounded lead. A lower rated fuse can be used based on the maximum inrush transient energy and maximum input current.

Soldering and Cleaning Considerations

Post solder cleaning is usually the final board assembly process before the board or system undergoes electrical testing. Inadequate cleaning and/or drying may lower the reliability of a power module and severely affect the finished circuit board assembly test. Adequate cleaning and/or drying is especially important for un-encapsulated and/or open frame type power modules. For assistance on appropriate soldering and cleaning procedures, please contact Delta's technical support team.



FEATURES DESCRIPTIONS

Over-Current Protection

The modules include an internal output over-current protection circuit. If the output current exceeds the OCP set point, the modules will automatically shut down, and enter hiccup mode or latch mode, which is optional.

For hiccup mode, the module will try to restart after shutdown. If the overload condition still exists, the module will shut down again. This restart trial will continue until the overload condition is corrected. Hiccup mode is default mode.

For latch mode, the module will latch off once it shutdown. The latch is reset by either cycling the input power or by toggling the on/off signal for one second.

Over-Voltage Protection

The modules include an internal output over-voltage protection circuit. If the output voltage exceeds the OVP set point, the modules will automatically shut down, and enter hiccup mode or latch mode, which is optional.

For hiccup mode, the module will try to restart after shutdown. If the over-voltage condition still exists, the module will shut down again. This restart trial will continue until the over-voltage condition is corrected. Hiccup mode is default mode.

For latch mode, the module will latch off once it shutdown. The latch is reset by either cycling the input power or by toggling the on/off signal for one second.

Over-Temperature Protection

The over-temperature protection consists of circuitry that provides protection from thermal damage. If the temperature exceeds the over-temperature threshold the module will shut down, and enter in auto-restart mode or latch mode, which is optional.

For auto-restart mode, the module will monitor the module temperature after shutdown. Once the temperature is within the specification, the module will be auto-restarted. Auto-restart mode is default mode.

For latch mode, the module will latch off once it shutdown. The latch is reset by either cycling the input power or by toggling the on/off signal for one second.

Remote On/Off

The remote on/off feature on the module can be either negative or positive logic. Negative logic turns the module on during a logic low and off during a logic high. Positive logic turns the modules on during a logic high and off during a logic low.

Remote on/off can be controlled by an external switch between the on/off terminal and the Vi(-) terminal. The switch can be an open collector or open drain.

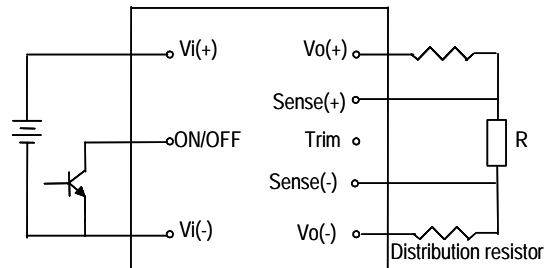

Figure 18: Remote on/off implementation

Remote Sense

Remote sense compensates for voltage drops on the output by sensing the actual output voltage at the point of load. The voltage between the remote sense pins and the output terminals must not exceed the output voltage sense range given here:

$$[Vo(+)-Vo(-)]-[SENSE(+)-SENSE(-)] \leq 10\% \times Vout$$

This limit includes any increase in voltage due to remote sense compensation and output voltage set point adjustment (trim).

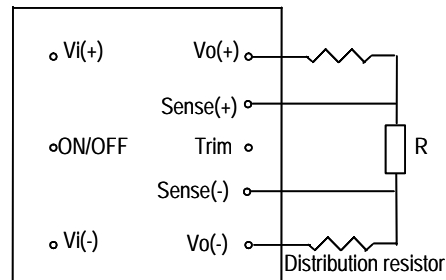

Figure 19: Effective circuit configuration for remote sense operation

If the remote sense feature is not used to regulate the output at the point of load, please connect SENSE(+) to Vo(+) and SENSE(-) to Vo(-) at the module.

The output voltage can be increased by both the remote sense and the trim; however, the maximum increase is the larger of either the remote sense or the trim, not the sum of both.

When using remote sense and trim, the output voltage of the module is usually increased, which increases the power output of the module with the same output current.

Care should be taken to ensure that the maximum output power does not exceed the maximum rated power.

FEATURES DESCRIPTIONS (CON.)

Output Voltage Adjustment (TRIM)

To increase or decrease the output voltage set point, the modules may be connected with an external resistor between the TRIM pin and either the SENSE(+) or SENSE(-). The TRIM pin should be left open if this feature is not used.

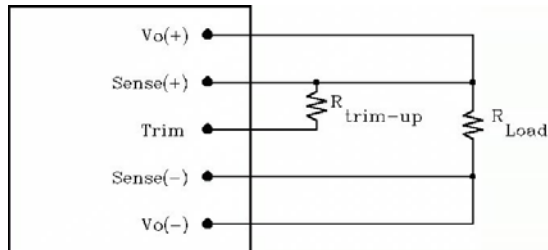

Figure 20: Circuit configuration for trim-up (increase output voltage)

If the external resistor is connected between the TRIM and SENSE (+) pins, the output voltage set point increases (Fig. 20). The external resistor value required to obtain a percentage of output voltage change $\Delta\%$ is defined as:

$$R_{\text{trim_up}} = \left[\frac{\left(\frac{12}{1.225} - 2 \right) \cdot (100 + \Delta) + 100}{\Delta} \right] \text{k}\Omega$$

Ex. When trim up to 13.2V from 12V
 $\Delta = 100 \cdot (13.2 - 12) / 12 = 10$

$$R_{\text{trim_up}} = \left[\frac{\left(\frac{12}{1.225} - 2 \right) \cdot (100 + 10) + 100}{10} \right] \text{k}\Omega$$

$R_{\text{trim_up}} = 95.755 \text{ k}\Omega$

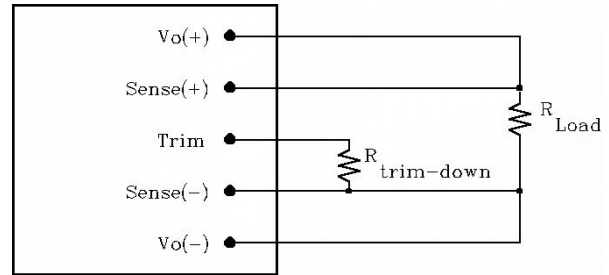

Figure 21: Circuit configuration for trim-down (decrease output voltage)

If the external resistor is connected between the TRIM and SENSE (-) the output voltage set point decreases (Fig. 21). The external resistor value required to obtain a percentage of output voltage change $\Delta\%$ is defined as:

$$R_{\text{trim_down}} = \left(\frac{100}{\Delta} - 2 \right) \text{k}\Omega$$

Ex. When trim down to 9.6V from 12V
 $\Delta = 100 \cdot (12 - 9.6) / 12 = 20$

$$R_{\text{trim_down}} = \left(\frac{100}{20} - 2 \right) \text{k}\Omega$$

$R_{\text{trim_down}} = 3 \text{ k}\Omega$

The typical resistor value can be seen in below figure 22.

Output voltage	Resistor value (k Ω)
13.2V	95.8
12.6V	183.7
10.8V	8.0
9.6V	3.0

Figure 22: Trim resistor value example for popular output voltages

The output voltage can be increased by both the remote sense and the trim, however the maximum increase is the larger of either the remote sense or the trim, not the sum of both.

When using remote sense and trim, the output voltage of the module is usually increased, which increases the power output of the module with the same output current.

Care should be taken to ensure that the maximum output power of the module remains at or below the maximum rated power.

THERMAL CONSIDERATIONS

Thermal management is an important part of the system design. To ensure proper, reliable operation, sufficient cooling of the power module is needed over the entire temperature range of the module. Convection cooling is usually the dominant mode of heat transfer.

Hence, the choice of equipment to characterize the thermal performance of the power module is a wind tunnel.

Thermal Testing Setup

Delta's DC/DC power modules are characterized in heated vertical wind tunnels that simulate the thermal environments encountered in most electronics equipment. This type of equipment commonly uses vertically mounted circuit cards in cabinet racks in which the power modules are mounted.

The following figure shows the wind tunnel characterization setup. The power module is mounted on a test PWB and is vertically positioned within the wind tunnel. The space between the neighboring PWB and the top of the power module is constantly kept at 6.35mm (0.25").

Thermal Derating

Heat can be removed by increasing airflow over the module. The module's maximum device temperature is to be defined and the measured location is illustrated in Figure 24. To enhance system reliability, the power module should always be operated below the maximum operating temperature. If the temperature exceeds the maximum module temperature, reliability of the unit may be affected.

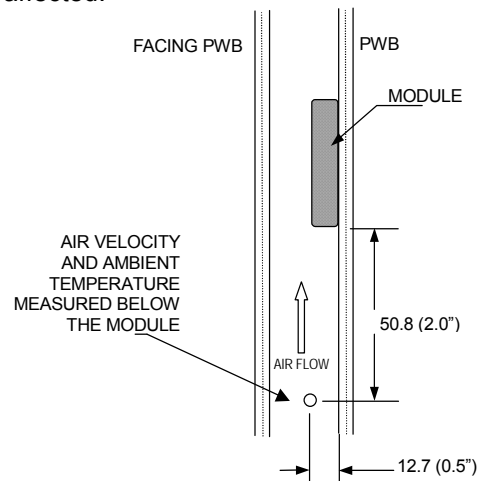

Note: Wind Tunnel Test Setup Figure Dimensions are in millimeters and (Inches)

Figure 23: Wind tunnel test setup

THERMAL CURVES

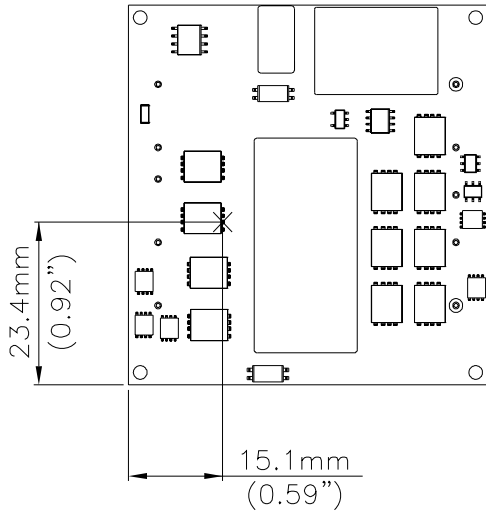

Figure 24: Temperature measurement location for openframe version - The allowed maximum hot spot temperature is defined at 122 °C.

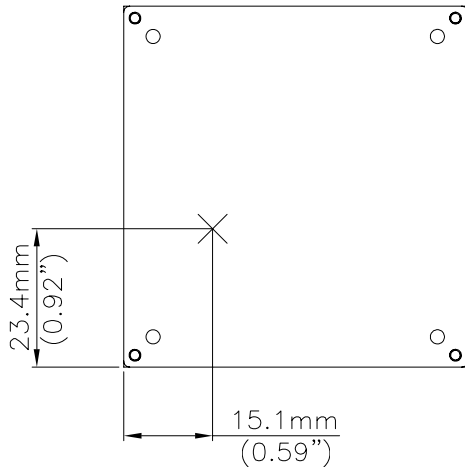

Figure 25: Temperature measurement location for heatspreader version - The allowed maximum hot spot temperature is defined at 109 °C.

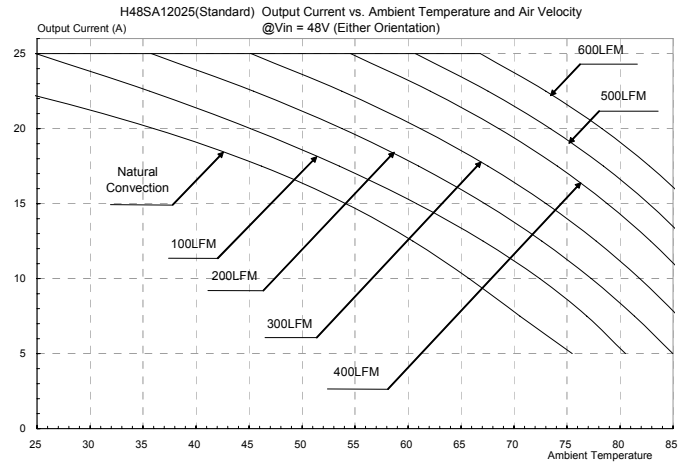

Figure 26: Output current vs. ambient temperature and air velocity @ $V_{in}=48V$, $V_{out}=12V$ (Openframe Version, Either Orientation).

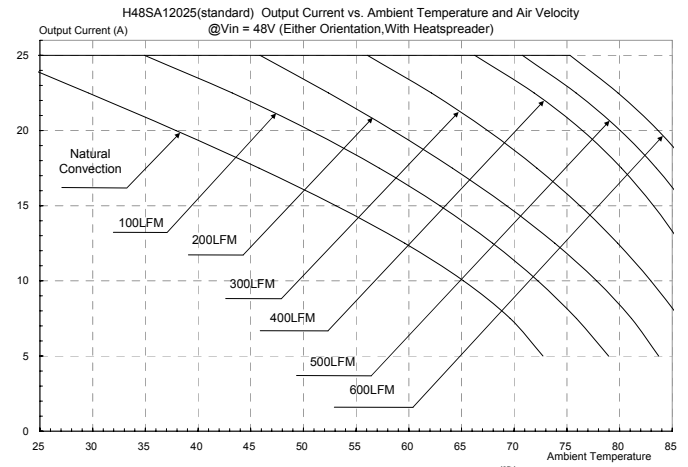
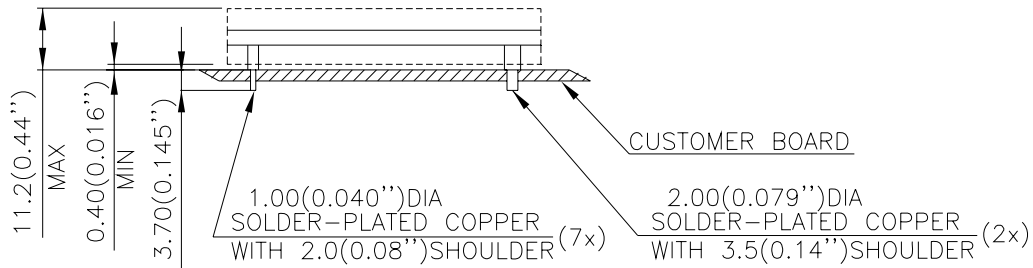
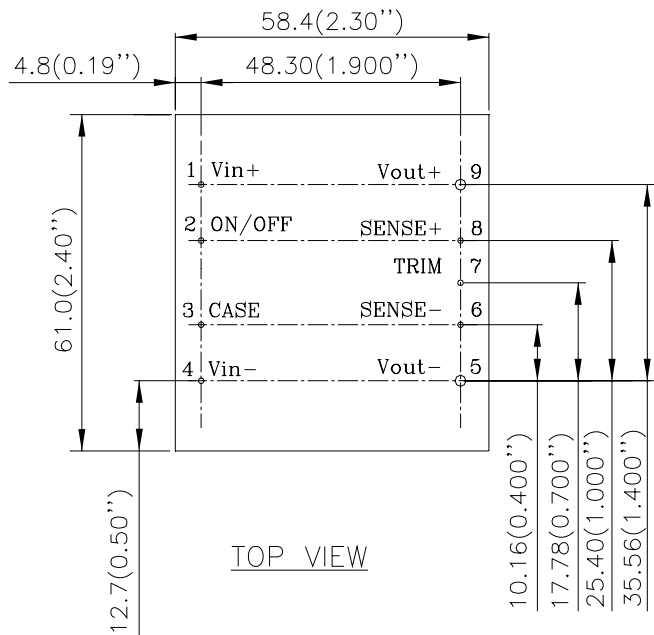

Figure 27: Output current vs. ambient temperature and air velocity @ $V_{in}=48V$, $V_{out}=12V$ (Heatspreader version, Either Orientation).

MECHANICAL DRAWING (WITHOUT HEATSPREADER)



SIDE VIEW

NOTES:
 DIMENSIONS ARE IN MILLIMETERS AND (INCHES)
 TOLERANCES: X.Xmm±0.5mm(X.XX in.±0.02 in.)
 X.XXmm±0.25mm(X.XXX in.±0.010 in.)

Pin No.	Name	Function
1	+Vin	Positive input voltage
2	ON/OFF	Remote ON/OFF
3	CASE	Case pin
4	-Vin	Negative input voltage
5	-Vout	Negative output voltage
6	-SENSE	Negative remote sense
7	TRIM	Output voltage trim
8	+SENSE	Positive remote sense
9	+Vout	Positive output voltage

Notes:

- 1 Pins 1-4, 6-8 are 1.00mm (0.040") diameter
- 2 Pins 5 and 9 are 2.00mm (0.079") diameter
- 3 All pins are copper with Tin plating.

MECHANICAL DRAWING (WITH HEATSPREADER)

For modules with optional heatspreader, they are intended for wave soldering assembly onto system boards, please do not subject modules with optional heatspreader through reflow temperature profile.

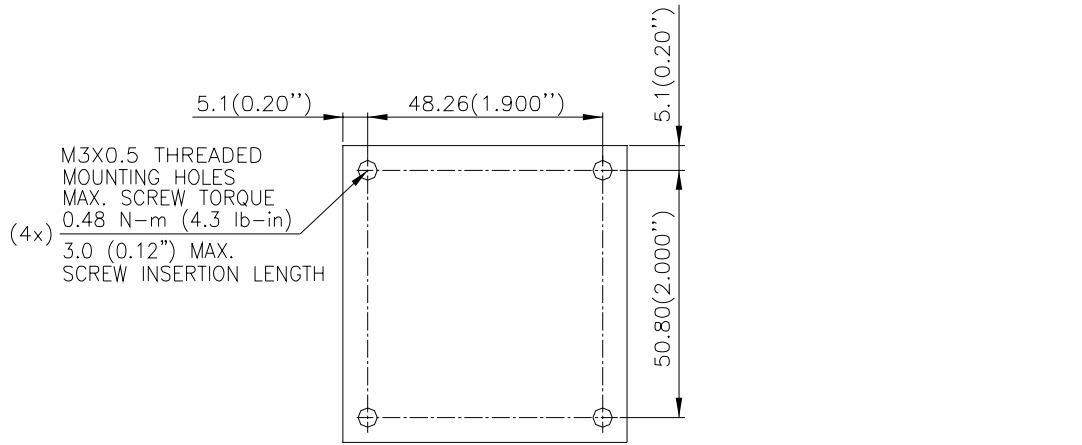

TOP VIEW

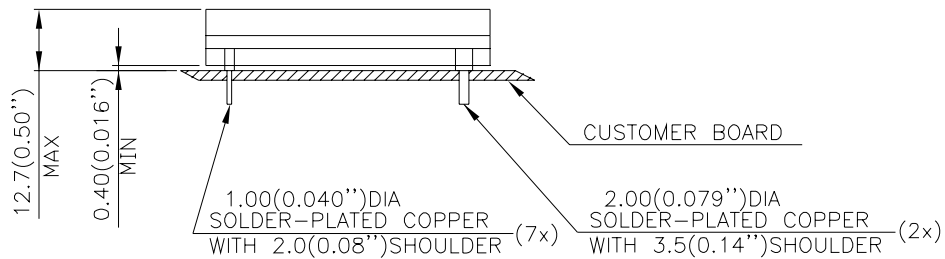

SIDE VIEW

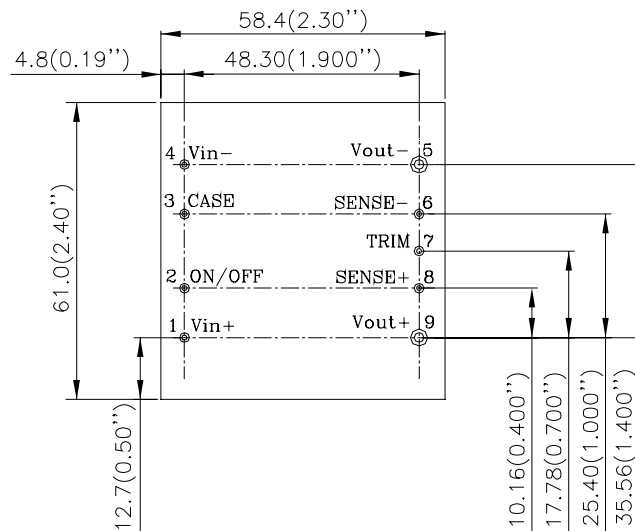

BOTTOM VIEW

NOTES:
 DIMENSIONS ARE IN MILLIMETERS AND (INCHES)
 TOLERANCES: X.Xmm±0.5mm(X.XX in.±0.02 in.)
 X.XXmm±0.25mm(X.XXX in.±0.010 in.)

PART NUMBERING SYSTEM

H	48	S	A	120	25	N	N	F	A
Form Factor	Input Voltage	Number of Outputs	Product Series	Output Voltage	Output Current	ON/OFF Logic	Pin Length		Option Code
H - Half-Brick	48V	S- Single	A - Advanced	120- 12V	25- 25A	N - Negative P - Positive	N - 0.145"	F- RoHS 6/6 (Lead Free)	A - Standard Functions H - with Heatspreader

MODEL LIST

Part Number	INPUT		OUTPUT		EFF @ 100% LOAD
H48SA12025NNFA	36V~75V	11A	12V	25A	93.2%

* For modules with through-hole pins and the optional heatspreader, they are intended for wave soldering assembly onto system boards, please do not subject such modules through reflow temperature profile.

CONTACT: www.delta.com.tw/dcdc

USA:

Telephone:
East Coast: (888) 335 8201
West Coast: (888) 335 8208
Fax: (978) 656 3964
Email: DCDC@delta-corp.com

Europe:

Phone: +41 31 998 53 11
Fax: +41 31 998 53 53
Email: DCDC@delta-es.com

Asia & the rest of world:

Telephone: +886 3 4526107 ext 6220
Fax: +886 3 4513485
Email: DCDC@delta.com.tw

WARRANTY

Delta offers a two (2) year limited warranty. Complete warranty information is listed on our web site or is available upon request from Delta.

Information furnished by Delta is believed to be accurate and reliable. However, no responsibility is assumed by Delta for its use, nor for any infringements of patents or other rights of third parties, which may result from its use. No license is granted by implication or otherwise under any patent or patent rights of Delta. Delta reserves the right to revise these specifications at any time, without notice.

Компания «Океан Электроники» предлагает заключение долгосрочных отношений при поставках импортных электронных компонентов на взаимовыгодных условиях!

Наши преимущества:

- Поставка оригинальных импортных электронных компонентов напрямую с производств Америки, Европы и Азии, а так же с крупнейших складов мира;
- Широкая линейка поставок активных и пассивных импортных электронных компонентов (более 30 млн. наименований);
- Поставка сложных, дефицитных, либо снятых с производства позиций;
- Оперативные сроки поставки под заказ (от 5 рабочих дней);
- Экспресс доставка в любую точку России;
- Помощь Конструкторского Отдела и консультации квалифицированных инженеров;
- Техническая поддержка проекта, помощь в подборе аналогов, поставка прототипов;
- Поставка электронных компонентов под контролем ВП;
- Система менеджмента качества сертифицирована по Международному стандарту ISO 9001;
- При необходимости вся продукция военного и аэрокосмического назначения проходит испытания и сертификацию в лаборатории (по согласованию с заказчиком);
- Поставка специализированных компонентов военного и аэрокосмического уровня качества (Xilinx, Altera, Analog Devices, Intersil, Interpoint, Microsemi, Actel, Aeroflex, Peregrine, VPT, Syfer, Eurofarad, Texas Instruments, MS Kennedy, Miteq, Cobham, E2V, MA-COM, Hittite, Mini-Circuits, General Dynamics и др.);

Компания «Океан Электроники» является официальным дистрибьютором и эксклюзивным представителем в России одного из крупнейших производителей разъемов военного и аэрокосмического назначения «**JONHON**», а так же официальным дистрибьютором и эксклюзивным представителем в России производителя высокотехнологичных и надежных решений для передачи СВЧ сигналов «**FORSTAR**».



JONHON

«**JONHON**» (основан в 1970 г.)

Разъемы специального, военного и аэрокосмического назначения:

(Применяются в военной, авиационной, аэрокосмической, морской, железнодорожной, горно- и нефтедобывающей отраслях промышленности)

«**FORSTAR**» (основан в 1998 г.)

ВЧ соединители, коаксиальные кабели, кабельные сборки и микроволновые компоненты:

(Применяются в телекоммуникациях гражданского и специального назначения, в средствах связи, РЛС, а так же военной, авиационной и аэрокосмической отраслях промышленности).



Телефон: 8 (812) 309-75-97 (многоканальный)

Факс: 8 (812) 320-03-32

Электронная почта: ocean@oceanchips.ru

Web: <http://oceanchips.ru/>

Адрес: 198099, г. Санкт-Петербург, ул. Калинина, д. 2, корп. 4, лит. А