

3 WATT DC-DC CONVERTER

OBQ-SC/OBQ-WC series

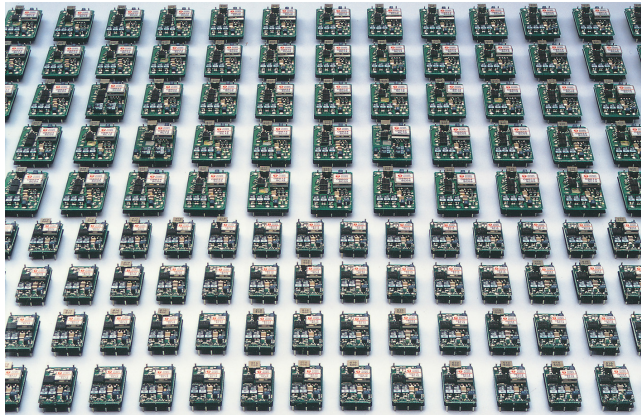

General Description

In response to market demand for “DISTRIBUTED POWER,” ETA has developed a new DC/DC converter suitable for PCB mounting. OB-Series AC/DC Switching Power Supplies are designed and built to be installed right onto the user’s printed circuit board like a piece of “patch-work”. They are small, light in weight and cost effective.

Features

1. PCB Mountable
2. Small , Light Weight
3. High Efficiency
4. Cost effective
5. Output Voltage adjustable
6. Over Voltage Protection

SC/WC05 Input Specifications

Specifications	Model							
	OBQ05SC05	OBQ12SC05	OBQ15SC05	OBQ24SC05	OBQ22WC05	OBQ23WC05		
OBQ**SC/WC05 3WATTS/SINGLE/2 OUTPUT								
Input Characteristic								
Input Voltage DC[V]	5	5	5	5	5	12	5	12
Input Range DC[V]	4.5-6							
Inrush Current [A]	Not specified							
Input Range								
at no load [mA](typical)	41	51	51	57	66	64	64	64
at full load[mA](typical)	676	789	779	800	843	356	800	342
Line Back Noise [mVp-p](typical)	200	100	200	200	200	100	200	100
Efficiency [%] (typical) *1	74	76	77	78	74	73	75	73

**ETA-USA**

HIGH QUALITY SWITCHING POWER SUPPLIES

SC/WC05 Output Specifications

Specifications	Model							
	OBQ05SC05	OBQ12SC05	OBQ15SC05	OBQ24SC05	OBQ22WC05		OBQ23WC05	
OBQ**SC/WC05 3WATTS/SINGLE/2 OUTPUT								
Output Voltage [V]	5	12	15	24	+12	-12	+15	-15
Output Current [A]	0.5	0.25	0.20	0.13	0.013-0.13		0.010-0.10	
Voltage Tolerance +/-[mV](max) *2	100	240	300	480	240	240	300	300
Ripple and Noise [mVp-p](max) *3	100							
Regulation								
a.Static Line Regulation [mV](max)	25	60	75	120	60	60	75	75
b.Dynamic Line Regulation +/-[mV](max) *4	250	200	200	200	200	200	200	200
c.Static Load Regulation [mV](max) *5	25	60	75	120	±1000	±1000	±1000	±1000
[mV](max) *6					±480	±480	±600	±600
[mV](max) *7					±60	±60	±75	±75
d.Temperature Coefficient *8	0.03%/°C(maximum)							
e.Drift[mV](maximum) *9	40	75	90	135	75	75	90	90
f.Dynamic Load Regulation +/- [mV](typ) *10	150	360	450	720	360	360	450	450
g.Recovery Time *4, *10	20mS(typical)							
Rise up time	10mS(typical) at rated input/output							
Hold up time	Not specified							
Functions								
Overcurrent Protection *10	Foldback/Current Limiting with automatic recovery at discontinuous short circuit conditions							
Overvoltage Protection	Not available							
Remote Sense	Not available							
Trimming of output voltage[mV] *11	+250	+250	+350	+650				
[mV] *12	-250	-900	-1600	-4000				
Input Fuse	Installed							
Environmental								
Operating Temperature (derating)	-20 to +71°C							
Operating Humidity	3.5%/°C (50oC to 71°C) (out of warranty >=71°C)							
Storage Temperature	20-90%/RH(non-condensing)							
Storage Humidity	-20 to +85°C							
Withstanding Voltage	20 to 90%/RH(non-condensing)							
Isolation Resistance	Primary-Secondary AC500V for 1minute							
Capacitance(input-output) [pF](typical)	Primary-Frame Ground 50MΩ(minimum) by DC500V insulation tester							
Vibration	2200							
Shock	5-10Hz:10mm double amplitude,10-55Hz:19.6m/s ² ,20minutes' period for 60minutes each along X,Y,Z axes(non-operating)							
Cooling	294m/s ²							
Weight (typical)	Convection							
	open board type:6g							

Conditions:

*1 at 25°C and rated input/output

*2 OBQ**WC0512 satisfies the above-mentioned specifications at the same load conditions on both outputs

*3 measured by a bayonet probe at the output connector at a 0 to 100MHz bandwidth

*4 when input voltage changed from 4.5V to 16V rapidly at rated output

*5 when output current changed from 0mA to rated current keeping the current of other output below minimum rated current at rated input

*6 when output current changed from minimum rated current to rated current keeping the current of other output above minimum rated current at rated input

*7 when output current of both outputs changed from 0mA to rated current identically at rated input

*8 at -20 to +71°C

*9 for 7hour period after 1hour warm-up at 25°C and rated input/output

*10 when output current changed rapidly between 25% and 75% of rated current at rated input

*11 to increase output voltage,put a resistor between pin"0" and trimming pin

*12 to reduce output voltage,put a resistor between pin"+" and trimming pin

SC/WC0512 Input Specifications

Specifications	Model											
	OBQ05SC0512		OBQ12SC0512		OBQ15SC0512		OBQ24SC0512		OBQ22WC0512		OBQ23WC0512	
OBQ**SC/WC0512 3WATTS/SINGLE/2 OUTPUT												
Input Characteristic												
Input Voltage DC[V]	5	12	5	12	5	12	5	12	5	12	5	12
Input Range DC[V]	4.5-16V											
Inrush Current [A]	Not specified											
Inrush Current [A]												
at no load [mA](typical)	41	44	51	54	51	53	57	59	66	64	64	64
at full load[mA](typical)	676	297	789	342	779	337	800	346	843	356	800	342
Line Back Noise [mVp-p](typical)	200	100	100	80	200	100	200	100	200	100	200	100
Efficiency [%] (typical) *1	74	70	76	73	77	74	78	75	74	73	75	73

**ETA-USA**

HIGH QUALITY SWITCHING POWER SUPPLIES

SC/WC0512 Output Specifications

Specifications	Model							
	OBQ05SC0512	OBQ12SC0512	OBQ15SC0512	OBQ24SC0512	OBQ22WC0512	OBQ23WC0512		
OBQ**SC/WC0512 3WATTS/SINGLE/2 OUTPUT								
Output Voltage [V]	5	12	15	24	+12	-12	+15	-15
Output Current [A]	0.5	0.25	0.20	0.13	0.013-0.13		0.010-0.10	
Voltage Tolerance +/-[mV](max) *2	100	240	300	480	240	240	300	300
Ripple and Noise [mVp-p](max) *3	100							
Regulation								
a.Static Line Regulation [mV](max)	25	60	75	120	60	60	75	75
b.Dynamic Line Regulation +/-[mV](max) *4	250	200	200	200	200	200	200	200
c.Static Load Regulation [mV](max) *5	25	60	75	120	±1000	±1000	±1000	±1000
[mV](max) *6					±480	±480	±600	±600
[mV](max) *7					±60	±60	±75	±75
d.Temperature Coefficient *8	0.03%/°C(maximum)							
e.Drift[mV](maximum) *9	40	75	90	135	75	75	90	90
f.Dynamic Load Regulation +/- [mV](typ) *10	150	360	450	720	360	360	450	450
g.Recovery Time *4, *10	20mS(typical)							
Rise up time	10mS(typical) at rated input/output							
Hold up time	Not specified							
Functions								
Overcurrent Protection *10	Foldback/Current Limiting with automatic recovery at discontinuous short circuit conditions							
Overvoltage Protection	Not available							
Remote Sence	Not available							
Trimming of output voltage[mV] *11	+250	+250	+350	+650				
[mV] *12	-250	-900	-1600	-4000				
Input Fuse	Installed							
Environmental								
Operating Temperature (derating)	-20 to +71°C							
Operating Humidity	3.5%/°C (50oC to 71°C) (out of warranty >=71°C)							
Storage Temperature	20-90%/RH(non-condensing)							
Storage Humidity	-20 to +85°C							
Withstanding Voltage	20 to 90%/RH(non-condensing)							
Isolation Resistance	Primary-Secondary AC500V for 1minute							
Capacitance(input-output) [pF](typical)	Primary-Frame Ground 50MΩ(minimum) by DC500V insulation tester							
Vibration	2200							
Shock	5-10Hz:10mm double amplitude.10-55Hz:19.6m/s ² 20minutes' period for 60minutes each along X.Y.Z axes(non-operating)							
Cooling	294m/s ²							
Weight (typical)	Convection							
	open board type:6g							

Conditions:

*1 at 25°C and rated input/output

*2 OBQ**WC0512 satisfies the above-mentioned specifications at the same load conditions on both outputs

*3 measured by a bayonet probe at the output connector at a 0 to 100MHz bandwidth

*4 when input voltage changed from 4.5V to 16V rapidly at rated output

*5 when output current changed from 0mA to rated current keeping the current of other output below minimum rated current at rated input

*6 when output current changed from minimum rated current to rated current keeping the current of other output above minimum rated current at rated input

*7 when output current of both outputs changed from 0mA to rated current identically at rated input

*8 at -20 to +71°C

*9 for 7hour period after 1hour warm-up at 25°C and rated input/output

*10 when output current changed rapidly between 25% and 75% of rated current at rated input

*11 to increase output voltage,put a resistor between pin"0" and trimming pin

*12 to reduce output voltage,put a resistor between pin"+" and trimming pin

**ETA-USA**

HIGH QUALITY SWITCHING POWER SUPPLIES

SC12 Input Specifications

Specifications	Model			
OBQ**SC12 3WATTS/SINGLE OUTPUT	OBQ05SC12	OBQ12SC12	OBQ15SC12	OBQ24SC12
Input Characteristic				
Input Voltage DC[V]	12	12	12	12
Input Range DC[V]	9-18V			
Inrush Current [A]	Not specified			
at no load [mA](typical)	41	51	51	57
at full load[mA](typical)	676	789	779	800
Line Back Noise [mVp-p](typical)	200	100	200	200
Efficiency [%] (typical) *1	74	77	77	78

**ETA-USA**

HIGH QUALITY SWITCHING POWER SUPPLIES

SC12 Output Specifications

Specifications	Model			
	OBQ05SC12	OBQ12SC12	OBQ15SC12	OBQ24SC12
OBQ**SC12 3WATTS/SINGLE/2 OUTPUT				
Output Voltage [V]	5	12	15	24
Output Current [A]	0.5	0.25	0.20	0.13
Voltage Tolerance +/-[mV](max) *2	100	240	300	480
Ripple and Noise [mVp-p](max) *3	100			
Regulation				
a.Static Line Regulation [mV](max)	25	60	75	120
b.Dynamic Line Regulation +/-[mV](max) *4	250	200	200	200
c.Static Load Regulation [mV](max) *5	25	60	75	120
[mV](max) *6				
[mV](max) *7				
d.Temperature Coefficient *8	0.03%/°C(maximum)			
e.Drift[mV](maximum) *9	40	75	90	135
f.Dynamic Load Regulation +/- [mV](typ) *10	150	360	450	720
g.Recovery Time *4, *10	20mS(typical)			
Rise up time	10mS(typical) at rated input/output			
Hold up time	Not specified			
Functions				
Overcurrent Protection *10	Foldback/Current Limiting with automatic recovery at discontinuous short circuit condi			
Overvoltage Protection	Not available			
Remote Sence	Not available			
Trimming of output voltage[mV] *11	+250	+250	+350	+650
[mV] *12	-250	-900	-1600	-4000
Input Fuse	Installed			
Environmental				
Operating Temperature	-20 to +71°C			
(derating)	3.5%/°C (50oC to 71°C) (out of warranty >=71°C)			
Operating Humidity	20-90%/RH(non-condensing)			
Storage Temperature	-20 to +85°C			
Storage Humidity	20 to 90%/RH(non-condensing)			
Withstanding Voltage	Primary-Secondary AC500V for 1minute			
Isolation Resistance	Primary-Frame Ground 50MΩ(minimum) by DC500V insulation tester			
Capacitance(input-output) [pF](typical)	2200			
Vibration	5-10Hz:10mm double amplitude,10-55Hz:19.6m/s ² ,20minutes' period for 60minutes each along X,Y,Z axes(non-operat			
Shock	294m/s ²			
Cooling	Convection			
Weight (typical)	open board type:6g			

Conditions:

*1 at 25°C and rated input/output

*2 OBQ**WC0512 satisfies the above-mentioned specifications at the same load conditions on both outputs

*3 measured by a bayonet probe at the output connector at a 0 to 100MHz bandwidth

*4 when input voltage changed from 4.5V to 16V rapidly at rated output

*5 when output current changed from 0mA to rated current keeping the current of other output below minimum rated current at rated input

*6 when output current changed from minimum rated current to rated current keeping the current of other output above minimum rated current at rated input

*7 when output current of both outputs changed from 0mA to rated current identically at rated input

*8 at -20 to +71°C

*9 for 7hour period after 1hour warm-up at 25°C and rated input/output

*10 when output current changed rapidly between 25% and 75% of rated current at rated input

*11 to increase output voltage,put a resistor between pin"0" and trimming pin

*12 to reduce output voltage,put a resistor between pin"+" and trimming pin

**ETA-USA**

HIGH QUALITY SWITCHING POWER SUPPLIES

SC/WC1224 Input Specifications

Specifications	Model											
OBQ**SC/WC1224 3WATTS/SINGLE/2 OUTPUT	OBQ05SC1224	OBQ12SC1224	OBQ15SC1224	OBQ24SC1224	OBQ22WC1224	OBQ23WC1224						
Input Characteristic												
Input Voltage DC[V]	12	24	12	24	12	24	12	24	12	24	12	24
Input Range DC[V]	8-32											
Inrush Current [A]	Not specified								9A/DC12V,18A/DC24V 10uS			
Inrush Current [A]												
at no load [mA](typical)	22	24	28	29	28	29	30	30	35	31	32	29
at full load[mA](typical)	267	144	312	168	304	164	317	171	329	173	308	164
Line Back Noise [mVp-p](typical)	300	150	300	150	300	150	300	150	1000	500	1000	500
Efficiency [%] (typical) *1	78	72	80	74	82	76	82	76	79	75	81	76

**ETA-USA**

HIGH QUALITY SWITCHING POWER SUPPLIES

SC/WC1224 Output Specifications

Specifications	Model							
	OBQ05SC1224	OBQ12SC1224	OBQ15SC1224	OBQ24SC1224	OBQ22WC1224		OBQ23WC1224	
OBQ**SC/WC1224 3WATTS/SINGLE/2 OUTPUT								
Output Voltage [V]	5	12	15	24	+12	-12	+15	-15
Output Current [A]	0.5	0.25	0.20	0.13	0.013-0.13		0.010-0.10	
Voltage Tolerance +/-[mV](maximum) *2	100	240	300	480	240	240	300	300
Ripple and Noise [mVp-p](maximum) *3	100							
Regulation								
a.Static Line Regulation [mV](maximum)	25	60	75	120	60	60	75	75
b.Dynamic Line Regulation +/-[mV](maximum) *4	200	200	200	200	300	300	300	300
c.Static Load Regulation [mV](maximum) *5	25	60	75	120	±1000	±1000	±1200	±1200
[mV](maximum) *6					±480	±480	±600	±600
[mV](maximum) *7					±60	±60	±75	±75
d.Temperature Coefficient *8	0.03%/°C(maximum)							
e.Drift[mV](maximum) *9	40	75	90	135	75	75	90	90
f.Dynamic Load Regulation [mV](maximum) *10	150	360	250	500	300	300	300	300
g.Recovery Time *4, *10	20mS(typical)							
Rise up time	10mS(typical) at rated input/output							
Hold up time	Not specified							
Functions								
Overcurrent Protection	Foldback/Current Limiting with automatic recovery at discontinuous short circuit conditions							
Overvoltage Protection	Not available							
Remote Sense	Not available							
Trimming of output voltage[mV] (typical) *11	+250	+250	+350	+650				
[mV](typical) *12	-250	-900	-1600	-4000				
Input Fuse	Installed							
Environmental								
Operating Temperature	-20 to 71°C							
(derating) *13	3.5%/(50°C to 71°C) (out of warranty ≥71°C)							
Operating Humidity	20-90%/RH(non-condensing)							
Storage Temperature	-20 to +85°C							
Storage Humidity	20 to 90%/RH(non-condensing)							
Withstanding Voltage	Primary-Secondary AC500V for 1minute							
Isolation Resistance	Primary-Secondary 50MΩ(minimum) by DC500V insulation tester							
Capacitance(input-output) [pF](typical)	2200							
Vibration	5-10Hz:10mm double amplitude,10-55Hz:19.6m/s ² ,20minutes' period for 60minutes each along X,Y,Z axes(non-operating)							
Shock	294m/s ²							
Cooling	Convection							
Weight (typical)	open board type:6g							

Conditions:

*1 at 25°C and rated input/output

*2 OBQ**WC0512 satisfies the above-mentioned specifications at the same load conditions on both outputs

*3 measured by a bayonet probe at the output connector at a 0 to 100Mhz bandwidth

*4 when input voltage changed from 8V to 32V rapidly at rated output

*5 when output current changed from 0mA to rated current keeping the current of other output below minimum rated current at rated input

*6 when output current changed from minimum rated current to rated current keeping the current of other output above minimum rated current at rated input

*7 when output current of both outputs changed from 0mA to rated current identically at rated input

*8 at -20 to +71°C

*9 for 7hour period after 1hour warm-up at 25°C and rated input/output

*10 when output current changed rapidly between 25% and 75% of rated current at rated input

*11 to increase output voltage,put a resistor between pin"0" and trimming pin

*12 to reduce output voltage,put a resistor between pin"+" and trimming pin

*13 operating temperature of OBQ**WC1224 should be ≤71-2*(Ein-24) at input voltage from 24V to 32V (Ein=Input Voltage)

**ETA-USA**

HIGH QUALITY SWITCHING POWER SUPPLIES

SC/WC2448 Input Specifications

Specifications	Model												
OBQ**SC/WC2448 3WATTS/SINGLE/2 OUTPUT	OBQ05SC2448	OBQ12SC2448	OBQ15SC2448	OBQ24SC2448	OBQ22WC2448	OBQ23WC2448							
Input Characteristic													
Input Voltage DC[V]	24	48	24	48	24	48	24	48	24	48	24	48	
Input Range DC[V]	18-72V												
Inrush Current [A]	Not specified												
Inrush Current [A]													
at no load [mA](typical)	10	11	15	15	15	15	15	15	15	14	14	14	14
at full load[mA](typical)	136	72	154	82	152	81	158	84.4	160	86	152	75	
Line Back Noise [mVp-p](typical)	100	80	100	80	100	80	100	80	200	100	200	100	
Efficiency [%] (typical) *1	76	72	81	76	82	77	82	77	81	76	82	76	

**ETA-USA**

HIGH QUALITY SWITCHING POWER SUPPLIES

SC/WC2448 Output Specifications

Specifications	Model							
	OBQ05SC2448	OBQ12SC2448	OBQ15SC2448	OBQ24SC2448	OBQ22WC2448		OBQ23WC2448	
OBQ**SC/WC2448 3WATTS/SINGLE/2 OUTPUT								
Output Voltage [V]	5	12	15	24	+12	-12	+15	-15
Output Current [A]	0.5	0.25	0.20	0.13	0.013-0.13		0.010-0.10	
Voltage Tolerance +/-[mV](maximum) *2	100	240	300	480	240	240	300	300
Ripple and Noise [mVp-p](maximum) *3	100							
Regulation								
a.Static Line Regulation [mV](maximum)	25	60	75	120	60	60	75	75
b.Dynamic Line Regulation +/-[mV](maximum) *4	250	200	200	200	300	300	300	300
c.Static Load Regulation [mV](maximum) *5	25	60	75	120	±1000	±1000	±1200	±1200
[mV](maximum) *6					±480	±480	±600	±600
[mV](maximum) *7					±60	±60	±75	±75
d.Temperature Coefficient *8	0.03%/°C(maximum)							
e.Drift[mV](maximum) *9	40	75	90	135	75	75	90	90
f.Dynamic Load Regulation [mV](maximum) *10	250	250	250	500	300	300	400	400
g.Recovery Time *4, *10	20mS(typical)							
Rise up time	10mS(typical) at rated input/output							
Hold up time	Not specified							
Functions								
Overcurrent Protection	Foldback/Current Limiting w ith automatic recovery at discontinuous short circuit conditions							
Overvoltage Protection	Not available							
Remote Sence	Not available							
Trimming of output voltage[mV] *11	+250	+250	+350	+650				
[mV] *12	-250	-900	-1600	-4000				
Input Fuse	Installed							
Environmental								
Operating Temperature (derating) *13	-20 to +71°C							
Operating Humidity	3.5%/°C (50°C to 71°C) (out of w arranty ≥ 71°C)							
Storage Temperature	20-90%/RH(non-condensing)							
Storage Humidity	-20 to +85°C							
Withstanding Voltage	20 to 90%/RH(non-condensing)							
Isolation Resistance	Primary-Secondary AC500V for 1minute							
Capacitance(input-output) [pF](typical)	Primary-Secondary 50MΩ(minimum) by DC500V insulation tester							
Vibration	2200							
Shock	5-10Hz:10mm double amplitude,10-55Hz:19.6m/s ² ,20minutes' period for 60minutes each along X,Y,Z axes(non-operating)							
Cooling	294m/s ²							
Weight (typical)	Convection							
	open board type:6g							

*1 at 25°C and rated input/output

*2 OBQ**WC2448 satisfies the above-mentioned specifications at the same load conditions on both outputs

*3 measured by a probe at the output connector at a 0 to 100MHz bandwidth

*4 when input voltage changed from 18V to 72V rapidly at rated output

*5 when output current changed from 0mA to rated current keeping the current of other output below minimum rated current at rated input

*6 when output current changed from minimum rated current to rated current keeping the current of other output above minimum rated current at rated input

*7 output current of both outputs changed from 0mA to rated current identically at rated input

*8 at -20 to +71°C

*9 for 7hour period after 1 hour warm-up at 25°C and rated input/output

*10 when output current changed rapidly between 25% and 75% of rated current at rated input

*11 to increase output voltage,put a resistor between pin"0" and trimming pin

*12 to reduce output voltage,put a resistor between pin"+" and trimming pin

*13 out of warranty ≥ 50°C at input voltage from 63V to 72V



ETA-USA

HIGH QUALITY SWITCHING POWER SUPPLIES

DIMENSION DIAGRAM

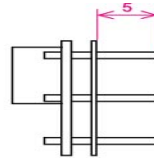
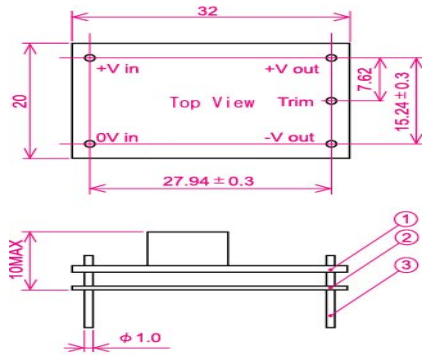

- ① Double-sided PCB FR4t=1.0
 - ② t=0.5 Insulator V0
 - ③ 1.0DIA PIN Material:BsB 2700 1/2H
Copper Plating 1~3μm
Solder Plating 3~6μm
- * Tolerance ±0.5

Dimension Diagram OBQ-SC2448

■ OBQ-SC/WC

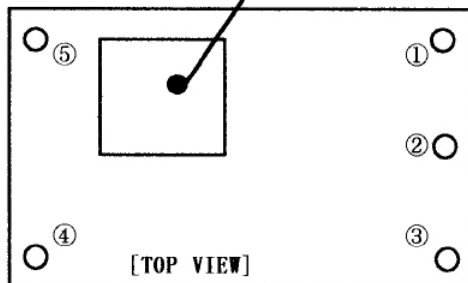

- ① : + [V]
- ② : COM
- ③ : 0 [V]
- ④ : DC 0 [V]
- ⑤ : DC + [V]



ETA-USA

HIGH QUALITY SWITCHING POWER SUPPLIES

EFFICIENCY CURVE

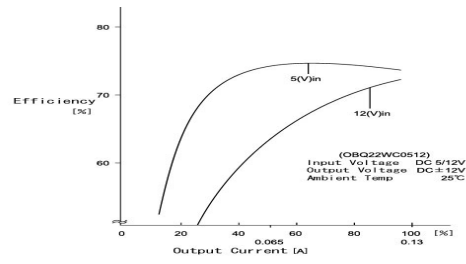

Efficiency Curve OBQ22WC0512

BLOCK DIAGRAM

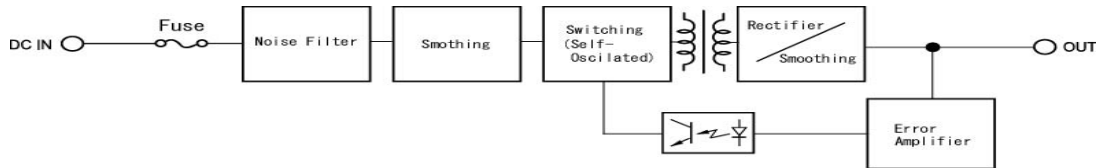

Block diagram OBQ-SC



ETA-USA

HIGH QUALITY SWITCHING POWER SUPPLIES

OCP CURVE

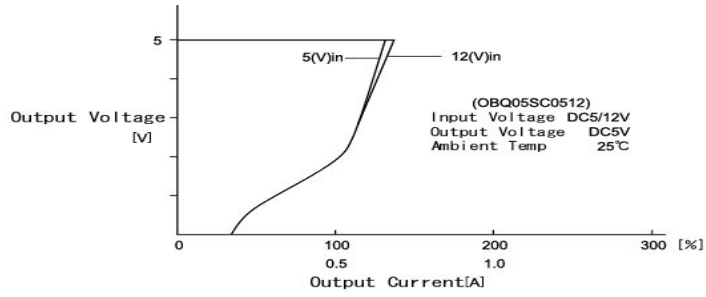

OCP Curve OBQ05SC0512



ETA-USA

HIGH QUALITY SWITCHING POWER SUPPLIES

DERATING CURVE

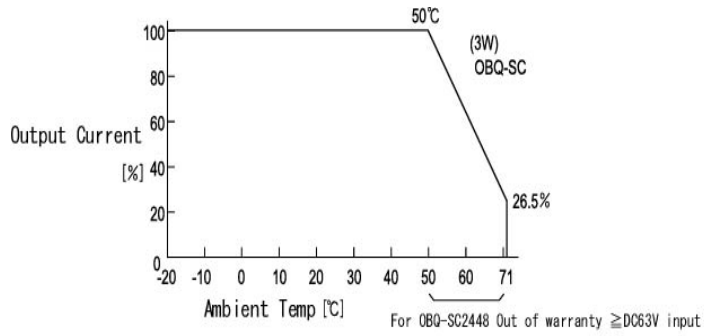

Derating Curve OBQ-SC-3W

Компания «Океан Электроники» предлагает заключение долгосрочных отношений при поставках импортных электронных компонентов на взаимовыгодных условиях!

Наши преимущества:

- Поставка оригинальных импортных электронных компонентов напрямую с производств Америки, Европы и Азии, а так же с крупнейших складов мира;
- Широкая линейка поставок активных и пассивных импортных электронных компонентов (более 30 млн. наименований);
- Поставка сложных, дефицитных, либо снятых с производства позиций;
- Оперативные сроки поставки под заказ (от 5 рабочих дней);
- Экспресс доставка в любую точку России;
- Помощь Конструкторского Отдела и консультации квалифицированных инженеров;
- Техническая поддержка проекта, помощь в подборе аналогов, поставка прототипов;
- Поставка электронных компонентов под контролем ВП;
- Система менеджмента качества сертифицирована по Международному стандарту ISO 9001;
- При необходимости вся продукция военного и аэрокосмического назначения проходит испытания и сертификацию в лаборатории (по согласованию с заказчиком);
- Поставка специализированных компонентов военного и аэрокосмического уровня качества (Xilinx, Altera, Analog Devices, Intersil, Interpoint, Microsemi, Actel, Aeroflex, Peregrine, VPT, Syfer, Eurofarad, Texas Instruments, MS Kennedy, Miteq, Cobham, E2V, MA-COM, Hittite, Mini-Circuits, General Dynamics и др.);

Компания «Океан Электроники» является официальным дистрибьютором и эксклюзивным представителем в России одного из крупнейших производителей разъемов военного и аэрокосмического назначения «**JONHON**», а так же официальным дистрибьютором и эксклюзивным представителем в России производителя высокотехнологичных и надежных решений для передачи СВЧ сигналов «**FORSTAR**».



JONHON

«**JONHON**» (основан в 1970 г.)

Разъемы специального, военного и аэрокосмического назначения:

(Применяются в военной, авиационной, аэрокосмической, морской, железнодорожной, горно- и нефтедобывающей отраслях промышленности)

«**FORSTAR**» (основан в 1998 г.)

ВЧ соединители, коаксиальные кабели,
кабельные сборки и микроволновые компоненты:

(Применяются в телекоммуникациях гражданского и специального назначения, в средствах связи, РЛС, а так же военной, авиационной и аэрокосмической отраслях промышленности).



Телефон: 8 (812) 309-75-97 (многоканальный)

Факс: 8 (812) 320-03-32

Электронная почта: ocean@oceanchips.ru

Web: <http://oceanchips.ru/>

Адрес: 198099, г. Санкт-Петербург, ул. Калинина, д. 2, корп. 4, лит. А