



MICROCHIP

HV7351
Ultrasound Tx Beamformer
Evaluation Board
User's Guide

Note the following details of the code protection feature on Microchip devices:

- Microchip products meet the specification contained in their particular Microchip Data Sheet.
- Microchip believes that its family of products is one of the most secure families of its kind on the market today, when used in the intended manner and under normal conditions.
- There are dishonest and possibly illegal methods used to breach the code protection feature. All of these methods, to our knowledge, require using the Microchip products in a manner outside the operating specifications contained in Microchip's Data Sheets. Most likely, the person doing so is engaged in theft of intellectual property.
- Microchip is willing to work with the customer who is concerned about the integrity of their code.
- Neither Microchip nor any other semiconductor manufacturer can guarantee the security of their code. Code protection does not mean that we are guaranteeing the product as "unbreakable."

Code protection is constantly evolving. We at Microchip are committed to continuously improving the code protection features of our products. Attempts to break Microchip's code protection feature may be a violation of the Digital Millennium Copyright Act. If such acts allow unauthorized access to your software or other copyrighted work, you may have a right to sue for relief under that Act.

Information contained in this publication regarding device applications and the like is provided only for your convenience and may be superseded by updates. It is your responsibility to ensure that your application meets with your specifications. MICROCHIP MAKES NO REPRESENTATIONS OR WARRANTIES OF ANY KIND WHETHER EXPRESS OR IMPLIED, WRITTEN OR ORAL, STATUTORY OR OTHERWISE, RELATED TO THE INFORMATION, INCLUDING BUT NOT LIMITED TO ITS CONDITION, QUALITY, PERFORMANCE, MERCHANTABILITY OR FITNESS FOR PURPOSE. Microchip disclaims all liability arising from this information and its use. Use of Microchip devices in life support and/or safety applications is entirely at the buyer's risk, and the buyer agrees to defend, indemnify and hold harmless Microchip from any and all damages, claims, suits, or expenses resulting from such use. No licenses are conveyed, implicitly or otherwise, under any Microchip intellectual property rights.

Trademarks

The Microchip name and logo, the Microchip logo, dsPIC, FlashFlex, flexPWR, JukeBlox, KEELOQ, KEELOQ logo, Klear, LANCheck, MediaLB, MOST, MOST logo, MPLAB, OptoLyzer, PIC, PICSTART, PIC³² logo, RightTouch, SpyNIC, SST, SST Logo, SuperFlash and UNI/O are registered trademarks of Microchip Technology Incorporated in the U.S.A. and other countries.

The Embedded Control Solutions Company and mTouch are registered trademarks of Microchip Technology Incorporated in the U.S.A.

Analog-for-the-Digital Age, BodyCom, chipKIT, chipKIT logo, CodeGuard, dsPICDEM, dsPICDEM.net, ECAN, In-Circuit Serial Programming, ICSP, Inter-Chip Connectivity, KlearNet, KlearNet logo, MiWi, MPASM, MPF, MPLAB Certified logo, MPLIB, MPLINK, MultiTRAK, NetDetach, Omniscient Code Generation, PICDEM, PICDEM.net, PICkit, PICtail, RightTouch logo, REAL ICE, SQI, Serial Quad I/O, Total Endurance, TSHARC, USBCheck, VariSense, ViewSpan, WiperLock, Wireless DNA, and ZENA are trademarks of Microchip Technology Incorporated in the U.S.A. and other countries.

SQTP is a service mark of Microchip Technology Incorporated in the U.S.A.

Silicon Storage Technology is a registered trademark of Microchip Technology Inc. in other countries.

GestIC is a registered trademarks of Microchip Technology Germany II GmbH & Co. KG, a subsidiary of Microchip Technology Inc., in other countries.

All other trademarks mentioned herein are property of their respective companies.

© 2015, Microchip Technology Incorporated, Printed in the U.S.A., All Rights Reserved.

ISBN: 978-1-63277-403-3

**QUALITY MANAGEMENT SYSTEM
CERTIFIED BY DNV
= ISO/TS 16949 =**

Microchip received ISO/TS-16949:2009 certification for its worldwide headquarters, design and wafer fabrication facilities in Chandler and Tempe, Arizona; Gresham, Oregon and design centers in California and India. The Company's quality system processes and procedures are for its PIC[®] MCUs and dsPIC[®] DSCs, KEELOQ[®] code hopping devices, Serial EEPROMs, microperipherals, nonvolatile memory and analog products. In addition, Microchip's quality system for the design and manufacture of development systems is ISO 9001:2000 certified.

Object of Declaration: HV7351 Ultrasound Tx Beamformer Evaluation Board

EU Declaration of Conformity

Manufacturer: Microchip Technology Inc.
2355 W. Chandler Blvd.
Chandler, Arizona, 85224-6199
USA

This declaration of conformity is issued by the manufacturer.

The development/evaluation tool is designed to be used for research and development in a laboratory environment. This development/evaluation tool is not a Finished Appliance, nor is it intended for incorporation into Finished Appliances that are made commercially available as single functional units to end users under EU EMC Directive 2004/108/EC and as supported by the European Commission's Guide for the EMC Directive 2004/108/EC (8th February 2010).

This development/evaluation tool complies with EU RoHS2 Directive 2011/65/EU.

This development/evaluation tool, when incorporating wireless and radio-telecom functionality, is in compliance with the essential requirement and other relevant provisions of the R&TTE Directive 1999/5/EC and the FCC rules as stated in the declaration of conformity provided in the module datasheet and the module product page available at www.microchip.com.

For information regarding the exclusive, limited warranties applicable to Microchip products, please see Microchip's standard terms and conditions of sale, which are printed on our sales documentation and available at www.microchip.com.

Signed for and on behalf of Microchip Technology Inc. at Chandler, Arizona, USA

Derek Carlson
VP Development Tools

12-Sep-14
Date

NOTES:



Table of Contents

Preface	7
Introduction.....	7
Document Layout	7
Conventions Used in this Guide	8
Recommended Reading.....	9
The Microchip Web Site	9
Customer Support	9
Document Revision History	9
Chapter 1. Product Overview	
1.1 Introduction	11
1.2 HV7351 Device Overview	11
1.3 Board Overview	11
1.4 What the HV7351 Ultrasound Tx Beamformer Evaluation Board Kit Includes	13
Chapter 2. Installation and Operation	
2.1 Getting Started	15
2.2 Setup Procedure	15
2.3 Evaluating The HV7351 Ultrasound Tx Beamformer Evaluation Board	18
2.4 Normal Operation	18
Chapter 3. Printed Circuit Board Layout Techniques	
Appendix A. Schematic and Layouts	
A.1 Introduction	21
A.2 Board – Schematic	22
A.3 Board – Top Layer	23
A.4 Board – Top Silk Layer	23
A.5 Board – Middle Layer	24
A.6 Board – Bottom Layer	24
A.7 Board – Bottom Silk Layer	25
A.8 Board – All Layers, and Dimension	25
Appendix B. Bill of Materials (BOM)	27
Appendix C. Plots and Waveforms	
C.1 HV7351 Typical Waveforms	29
Worldwide Sales and Service	34

HV7351 Ultrasound Tx Beamformer Evaluation Board User's Guide

NOTES:

Preface

NOTICE TO CUSTOMERS

All documentation becomes dated, and this manual is no exception. Microchip tools and documentation are constantly evolving to meet customer needs, so some actual dialogs and/or tool descriptions may differ from those in this document. Please refer to our web site (www.microchip.com) to obtain the latest documentation available.

Documents are identified with a “DS” number. This number is located on the bottom of each page, in front of the page number. The numbering convention for the DS number is “DSXXXXXXXXA”, where “XXXXXXXX” is the document number and “A” is the revision level of the document.

For the most up-to-date information on development tools, see the MPLAB® IDE online help. Select the Help menu, and then Topics to open a list of available online help files.

INTRODUCTION

This chapter contains general information that will be useful to know before using the HV7351 Ultrasound Tx Beamformer Evaluation Board. Items discussed in this chapter include:

- Document Layout
- Conventions Used in this Guide
- Recommended Reading
- The Microchip Web Site
- Customer Support
- Document Revision History

DOCUMENT LAYOUT

This document describes how to use the HV7351 Ultrasound Tx Beamformer Evaluation Board as a development tool to emulate and debug firmware on a target board. The manual layout is as follows:

- **Chapter 1. “Product Overview”** – Important information about the HV7351 Ultrasound Tx Beamformer Evaluation Board.
- **Chapter 2. “Installation and Operation”** – This chapter includes a detailed description of each function of the demonstration board and instructions on how to begin using the board.
- **Chapter 3. “Printed Circuit Board Layout Techniques”** – This chapter provides in-depth information on the recommended PCB Layout Techniques to optimally use the board.
- **Appendix A. “Schematic and Layouts”** – Shows the schematic and layout diagrams for the HV7351 Ultrasound Tx Beamformer Evaluation Board.
- **Appendix B. “Bill of Materials (BOM)”** – Lists the parts used to build the HV7351 Ultrasound Tx Beamformer Evaluation Board.
- **Appendix C. “Plots and Waveforms”** – Describes the various plots and waveforms for the HV7351 Ultrasound Tx Beamformer Evaluation Board.

CONVENTIONS USED IN THIS GUIDE

This manual uses the following documentation conventions:

DOCUMENTATION CONVENTIONS

Description	Represents	Examples
Arial font:		
Italic characters	Referenced books	<i>MPLAB® IDE User's Guide</i>
	Emphasized text	...is the <i>only</i> compiler...
Initial caps	A window	the Output window
	A dialog	the Settings dialog
	A menu selection	select Enable Programmer
Quotes	A field name in a window or dialog	"Save project before build"
Underlined, italic text with right angle bracket	A menu path	<u><i>File>Save</i></u>
Bold characters	A dialog button	Click OK
	A tab	Click the Power tab
N'Rnnnn	A number in verilog format, where N is the total number of digits, R is the radix and n is a digit.	4'b0010, 2'hF1
Text in angle brackets < >	A key on the keyboard	Press <Enter>, <F1>
Courier New font:		
Plain Courier New	Sample source code	#define START
	Filenames	autoexec.bat
	File paths	c:\mcc18\h
	Keywords	_asm, _endasm, static
	Command-line options	-Opa+, -Opa-
	Bit values	0, 1
	Constants	0xFF, 'A'
Italic Courier New	A variable argument	<i>file.o</i> , where <i>file</i> can be any valid filename
Square brackets []	Optional arguments	mcc18 [options] <i>file</i> [options]
Curly brackets and pipe character: { }	Choice of mutually exclusive arguments; an OR selection	errorlevel {0 1}
Ellipses...	Replaces repeated text	var_name [, var_name...]
	Represents code supplied by user	void main (void) { ... }

RECOMMENDED READING

This user's guide describes how to utilize the HV7351 Ultrasound Tx Beamformer Evaluation Board. Another useful document is listed below. The following Microchip document is available and recommended as a supplemental reference resource.

- **HV7351 Data Sheet – “8-Channel $\pm 70V$ 3A Programmable High Voltage Ultrasound Transmit Beamformer” (DS20005412).**

THE MICROCHIP WEB SITE

Microchip provides online support via our web site at www.microchip.com. This web site is used as a means to make files and information easily available to customers. Accessible by using your favorite Internet browser, the web site contains the following information:

- **Product Support** – Data sheets and errata, application notes and sample programs, design resources, user's guides and hardware support documents, latest software releases and archived software
- **General Technical Support** – Frequently Asked Questions (FAQs), technical support requests, online discussion groups, Microchip consultant program member listing
- **Business of Microchip** – Product selector and ordering guides, latest Microchip press releases, listing of seminars and events, listings of Microchip sales offices, distributors and factory representatives

CUSTOMER SUPPORT

Users of Microchip products can receive assistance through several channels:

- Distributor or Representative
- Local Sales Office
- Field Application Engineer (FAE)
- Technical Support

Customers should contact their distributor, representative or field application engineer (FAE) for support. Local sales offices are also available to help customers. A listing of sales offices and locations is included in the back of this document.

Technical support is available through the web site at:

<http://www.microchip.com/support>

DOCUMENT REVISION HISTORY

Revision A (June 2015)

- Initial Release of this Document.

NOTES:

Chapter 1. Product Overview

1.1 INTRODUCTION

This chapter discusses the following topics:

- HV7351 Device Overview
- Board Overview
- What the HV7351 Ultrasound Tx Beamformer Evaluation Board Kit Includes

1.2 HV7351 DEVICE OVERVIEW

The Microchip Technology Inc. HV7351 is a monolithic, eight channel, high-speed, high-voltage ultrasound transmitter Return-To-Zero (RTZ) programmable pulser. This integrated, high-performance circuit comes in a single 11 x 11 x 0.9 mm, 80-lead DFN package.

Each channel is capable of swinging up to $\pm 70V$ with an active discharge back to 0V. The outputs can source and sink more than 3A to achieve fast output rise and fall times. The active discharge is also capable of sourcing and sinking 3A for a fast return to ground. The digital beamforming topology of the HV7351 will significantly reduce the number of I/O logic control lines to the transmitter.

Each output is controlled by a 16 or 32-bit serial shift register. An arbitrary pattern can be generated depending on what is loaded into the shift registers, including four independent pattern options.

Once the patterns are loaded, the user can quickly select any of the four predefined patterns without having to clock in new data. A programmable 10-bit delay counter is provided for each output. This allows the user to program different delay times for each channel for beamforming.

1.3 BOARD OVERVIEW

There are two built-in Complex Programmable Logic Devices (CPLDs) and one serial EEPROM on the board to provide multiple demo waveform patterns. Other custom experimental data can be easily downloaded to these CPLDs/PROMs via the 6-pin Joint Test Action Group (JTAG) interface.

The HV7351 Board output waveforms can be directly displayed using an oscilloscope, by connecting the scope probe to the test points TX1 - TX8 and GND. The soldering jumper can select whether or not to connect the on-board dummy-load, a 330 pF capacitor paralleling with a 2.5 k Ω resistor. The test points can be used to connect the user's transducer to easily evaluate the pulser.

HV7351 Ultrasound Tx Beamformer Evaluation Board User's Guide

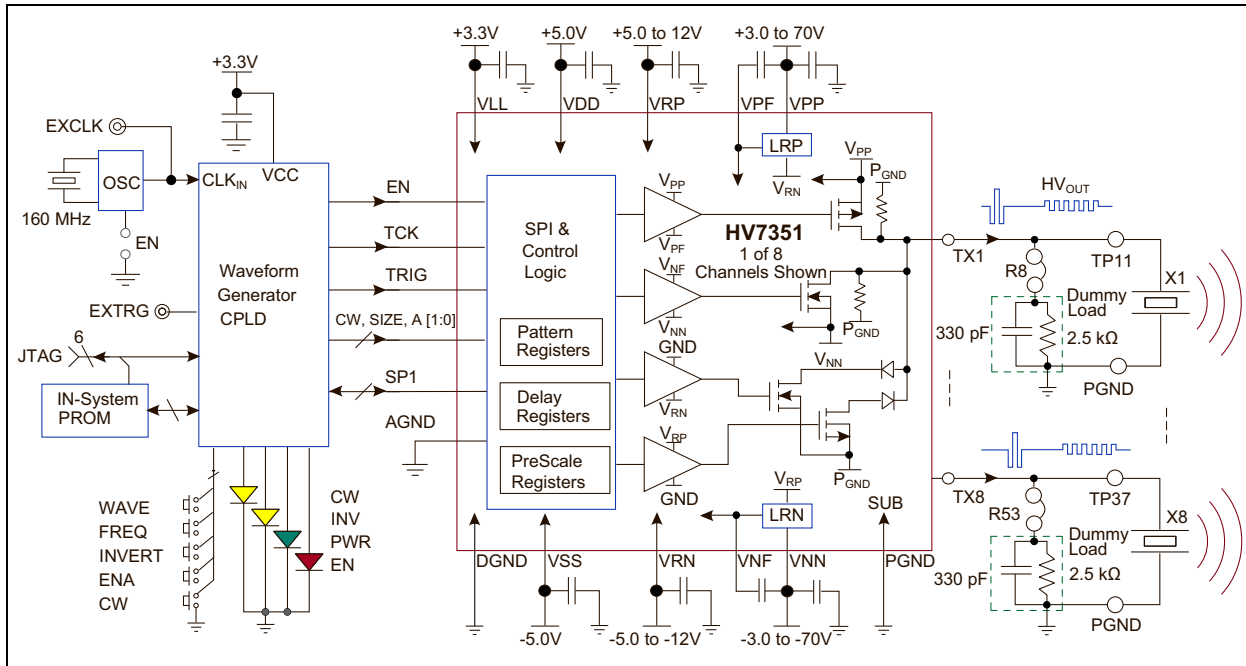

FIGURE 1-1: Block Diagram.

1.3.1 Board Features

- Two CPLDs provided to program a wide variety of data patterns that can be transmitted.
- Push-button selection of various Waveforms, Transmission Frequency, Waveform Inversion, Mode (Brightness or Continuous Wave mode) and Enable (see [Table 2-3](#) in [Chapter 2. "Installation and Operation"](#))
- LED indication of push button operations (see [Table 2-4](#) in [Chapter 2. "Installation and Operation"](#))
- Ability to bypass the crystal oscillator provided with an external clock source
- Numerous test points for probing of various input and output signals

1.3.2 HV7351 Ultrasound Tx Beamformer Evaluation Board Hardware Components

The HV7351 Ultrasound Tx Beamformer Evaluation Board contains several components:

- One HV7351 8-Channel $\pm 70V$, 3A Programmable Ultrasound Transmit Beamformer.
- Two Xilinx Inc. XC9572XL_VQ44 CPLDs
- Two Xilinx Inc. XCF01SVO20C PROM
- One Fox Electronics FXO-HC73-160 crystal oscillator running at 160 MHz

TABLE 1-1: TECHNICAL SPECIFICATIONS

Parameter	Value
Modes of Operation	B-mode and CW-mode
Input Logic Level	3.3V
Transmission Frequency	1 MHz – 10 MHz
High Voltage Supply Range	$\pm 3V$ – $\pm 70V$
Load on Each Channel	330 pF 2.5 k Ω

1.4 WHAT THE HV7351 ULTRASOUND TX BEAMFORMER EVALUATION BOARD KIT INCLUDES

The HV7351 Ultrasound Tx Beamformer Evaluation Board Kit includes:

- HV7351 Ultrasound Tx Beamformer Evaluation Board (ADM00658)
- Important Information Sheet

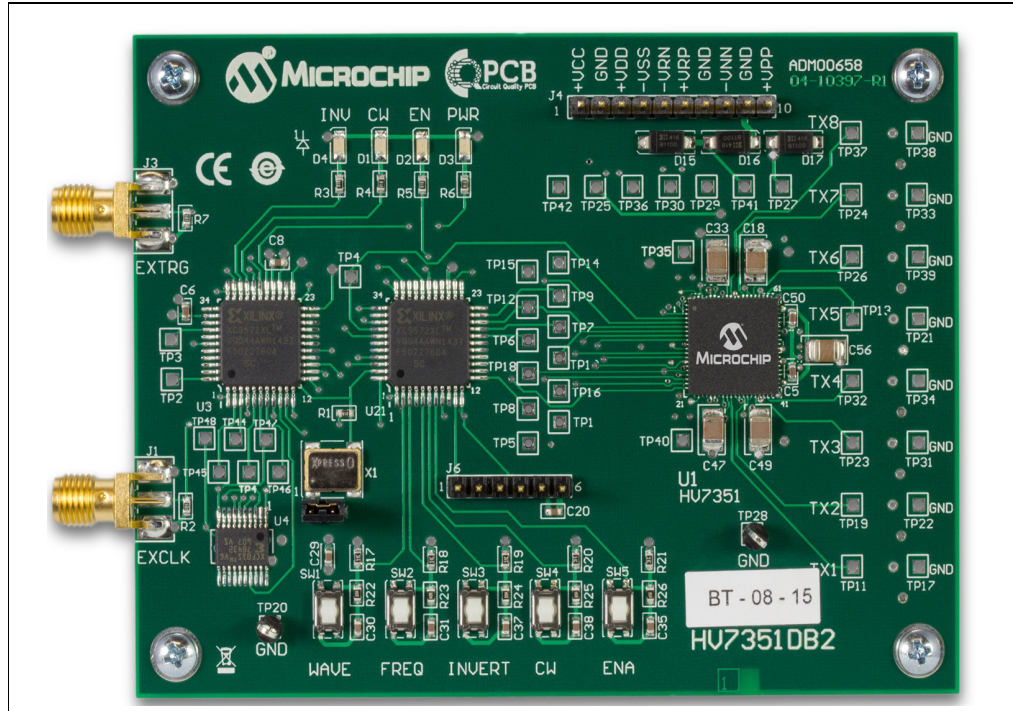

FIGURE 1-2: HV7351 Ultrasound Tx Beamformer Evaluation Board Front View.

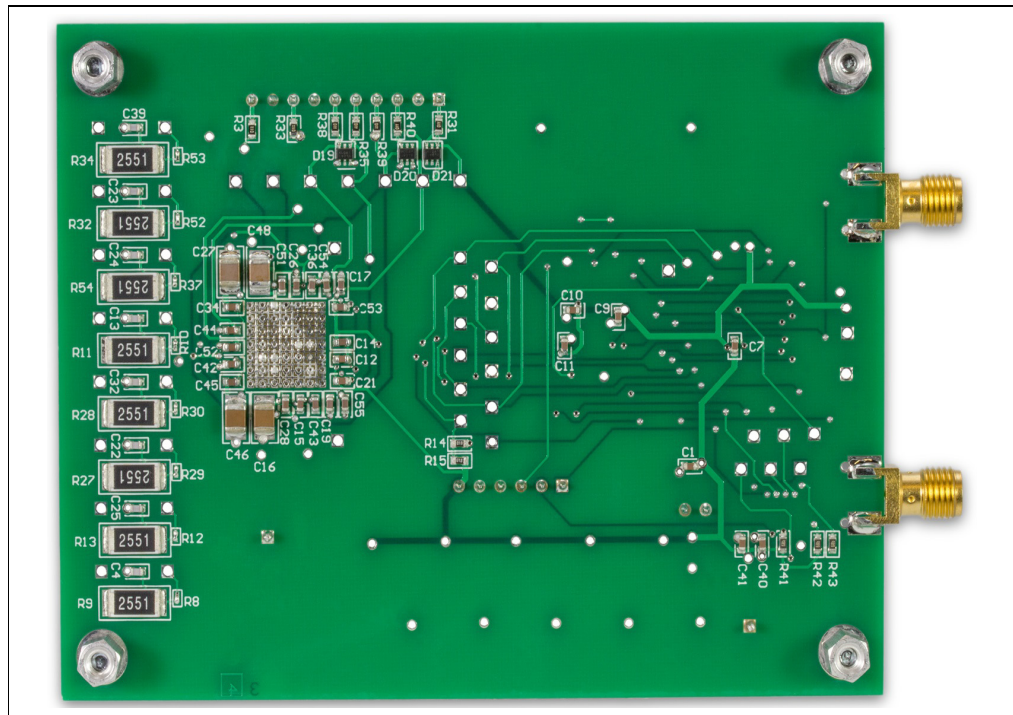

FIGURE 1-3: HV7351 Ultrasound Tx Beamformer Evaluation Board Back View.

NOTES:



HV7351 ULTRASOUND TX BEAMFORMER EVALUATION BOARD USER'S GUIDE

Chapter 2. Installation and Operation

2.1 GETTING STARTED

The HV7351 Ultrasound Tx Beamformer Evaluation Board is fully assembled and tested. The board requires external voltage sources.

2.1.1 Additional Tools Required for Operation

- A DC power supply, a bench supply that can produce 3.3V, 5V, -5V, 12V, -12V, 70V and -70V
- An oscilloscope and/or a multi-meter to observe the waveforms and measure electrical parameters

2.2 SETUP PROCEDURE

To operate the HV7351 Ultrasound Tx Beamformer Evaluation Board, the following steps must be followed:

WARNING

Read the HV7351 Ultrasound Tx Beamformer Evaluation Board User's Guide (this document) fully before proceeding to board setup.

1. Connect the supplies correctly to the board as shown in [Figure 2-1](#).
2. Set the voltages and current limits of the supply rails according to [Table 2-1](#), before connecting the power connector J4.

TABLE 2-1: POWER CONNECTOR DESCRIPTION

Pin	Name	Description
1	VCC	+3.3V Logic voltage input for V_{LL} and CPLD, 200 mA
2	GND	0V, Ground
3	VDD	+5.0V HV7351 Board positive V_{DD} supply, 50 mA
4	VSS	-5.0V HV7351 Board negative V_{SS} supply, 50 mA
5	VRN	-5.0V to -12V HV7351 Board negative regulator supply, 50 mA
6	VRP	+5.0V to +12V HV7351 Board positive regulator supply, 50 mA
7	GND	0V, Ground
8	VNN	-3.0V to -70V negative high-voltage supply, 10 mA to 50 mA (Note 1)
9	GND	0V, Ground
10	VPP	+3.0V to +70V positive high-voltage supply, 10 mA to 50 mA (Note 1)

Note 1: The current limits given for V_{PP} and V_{NN} are good for the supplied CPLD program in which B/CW-mode transmission is limited to about 16 cycles. If the user reprograms the CPLD for more CW cycles, the current limits need to be similarly increased.

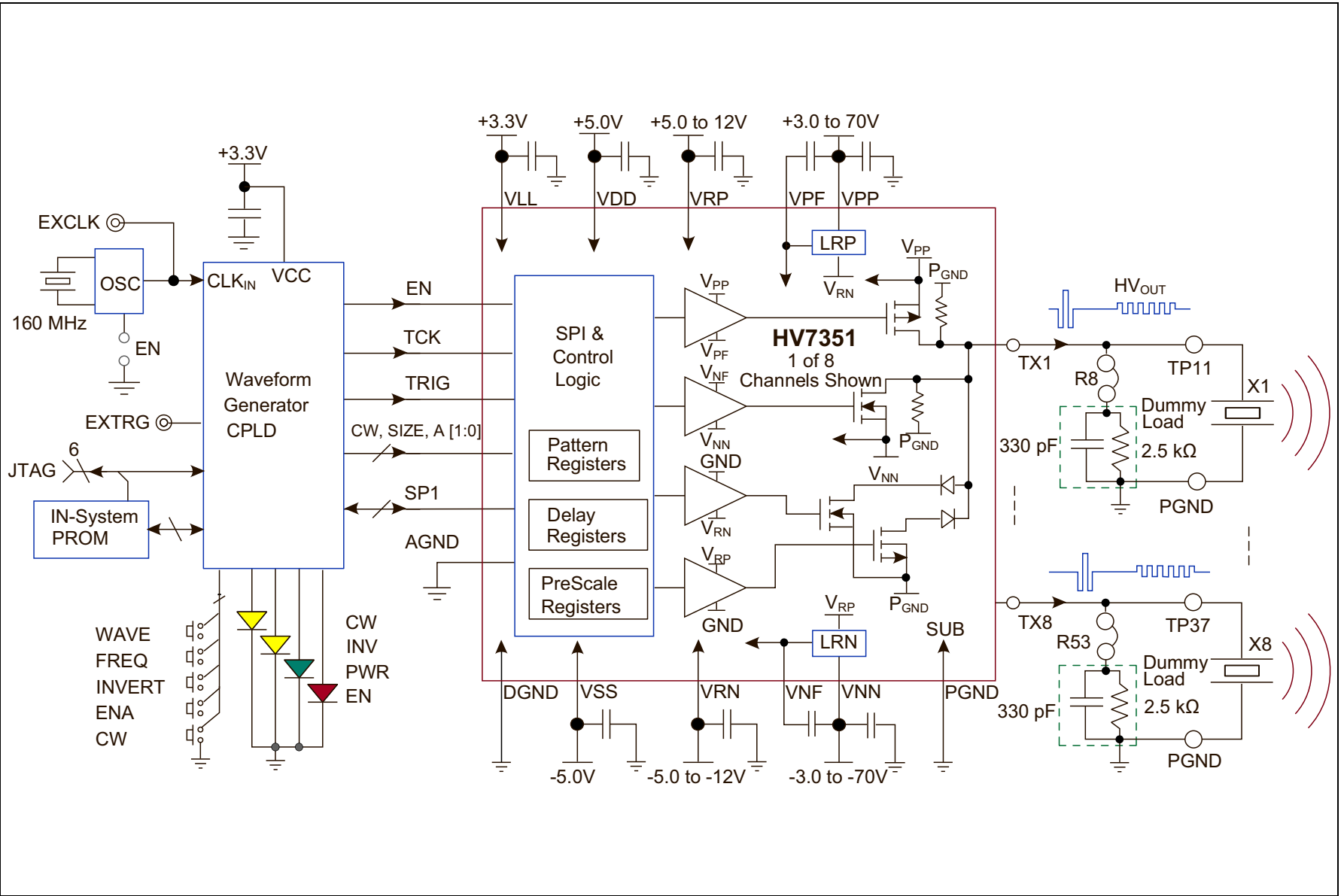

FIGURE 2-1: Power Supply and Load Connection Diagram.

3. Connect the high-impedance probe(s) of the oscilloscope to the Tx output(s).
4. Power up the supplies according to the power-up sequence as indicated in [Table 2-2](#).

TABLE 2-2: SUPPLY POWER-UP SEQUENCE

Step	Name	Description
1	+VCC	+3.3V positive logic supply voltage for HV7351 Board V_{LL} and CPLD V_{CC}
2	+VDD	+5.0V positive power supply
3	-VSS	-5.0V negative power supply
4	+VRP	+5V to +12.0V positive CW power supply
5	-VRN	-5V to -12.0V positive CW power supply
6	+VPP	+3V to +70V positive high voltage supply
7	-VNN	-3V to -70V positive high voltage supply

5. After the HV7351 Board has been successfully powered up by following the power-up sequence, enable the board by pressing the ENA button.
6. Change the output waveform and transmit frequency by pressing the WAVE and FREQ buttons, respectively. An overview of Push Button Operations is provided in [Table 2-3](#).

TABLE 2-3: PUSH BUTTON OPERATIONS

Button	Description
WAVE	Toggle select pulse waveforms
FREQ	Toggle select B-mode demo frequency
INVERT	Toggle select non-inverting or inverting waveform
CW	Toggle select CW-mode or B-mode (Note 1)
ENA	Toggle ON or OFF HV7351 Board enable signal EN

Note 1: In CW-mode, V_{PP}/V_{NN} voltages must be reduced to $\leq \pm 8V$

7. The output waveform can be inverted by pressing the INVERT button. [Table 2-4](#) lists all LED Indicators.

TABLE 2-4: LED INDICATORS

LED	Description
CW	CW-mode indicator
INVERT	Inverting waveform output indicator
PWR	V_{LL} 3.3V and CPLD chip V_{CC} power supply ON indicator
ENA	IC-enabled indicator. CPDL power-up default is OFF

8. The transmission mode can be toggled by pressing the CW button. In CW-mode, the typical waveforms are 16-cycle 5 MHz. To prevent the HV7351 Board from overheating, the following parameters are recommended when setting V_{PP}/V_{NN} voltages in CW-mode:
 - $+3V \leq V_{PP} \leq +8V$
 - $-3V \geq V_{NN} \geq -8V$

WARNING

Carefully double-check the voltage of every supply rail, current-limit value and polarity individually to avoid board damage.

Take extreme care while connecting the supplies to the board since connecting them incorrectly to the wrong pins could result in permanent damage to the entire board.

2.3 EVALUATING THE HV7351 ULTRASOUND TX BEAMFORMER EVALUATION BOARD

The best way to evaluate the HV7351 Ultrasound Tx Beamformer Evaluation Board is to explore the circuit and measure the voltages and currents with a Digital Voltage Meter (DVM) while probing the board with an oscilloscope.

2.4 NORMAL OPERATION

The HV7351 Ultrasound Tx Beamformer Evaluation Board should be powered up with multiple lab DC power supplies that feature current-limiting functions.

To meet the typical loading condition when using the high-impedance probe of an oscilloscope, the on-board dummy load (330 pF||2.5 k Ω) should be connected to the high-voltage pulser output through the solder jumper. To evaluate different loading conditions, the values of the RC may be changed within the current and power limits of the device.

In order to drive the user's piezoelectric transducers with a cable, the output load impedance should be properly matched to avoid cable and transducer reflections.

A 70 to 75 k Ω coaxial cable is recommended. The coaxial cable end should be soldered to the TX1 - TX8 and GND directly with very short leads. If the user's load is being used, the on-board dummy load should be disconnected by cutting the small shorting copper trace in between the 0k Ω resistors (R8, R12, R29, R30, R10, R37, R52 and R53) and the eight resistor pads. They are shorted by factory default.

All on-board test points are designed to work with the high-impedance probe of an oscilloscope. Some probes may have limited input voltage range. When using the probe on these high-voltage test points, make sure that the V_{PP}/V_{NN} voltages do not exceed the probe limit. When using the high-impedance oscilloscope probe on the on-board test points, it is important to have short ground leads to the circuit board ground plane.

Chapter 3. Printed Circuit Board Layout Techniques

The large thermal pad at the bottom of the HV7351 package is internally connected to the IC's substrate (V_{SUB}). This thermal pad should be connected to 0V or GND externally on the PCB. The designer needs to pay attention to the connecting traces on the outputs TX1 - TX8, specifically the high-voltage and high-speed traces. In particular, controlled impedance to ground plane and more trace spacing needs to be applied in such situations.

High-speed PCB trace design practices that are compatible with about 50 MHz to 100 MHz operating speeds are used for the HV7351 PCB layout. The internal circuitry of the HV7351 can operate at rather high frequencies, the primary speed limitation being the load capacitance.

Because of the high-speed and high-transient currents that result when driving capacitive loads, the supply-voltage bypass capacitors should be as close to the pins as possible. The GND pin should have low inductance feed-through via connections that are soldered directly to a solid ground plane.

The device's V_{LL} , AV_{DD} , DV_{DD} , PV_{DD} , PV_{SS} , V_{PP} , V_{NN} , V_{PF} , V_{NF} and V_{RN} voltage supplies and bypass capacitors pins must have a ceramic capacitor per pin and be placed close to the pin. A ceramic capacitor of 1.0 μ F may be used. Only the V_{PP} and V_{NN} to GND capacitors need to be high-voltage type. The V_{PF} to V_{PP} and V_{NF} to V_{NN} capacitors can be low-voltage.

It is advisable to minimize the trace length to the ground plane and to insert a ferrite bead in the power supply lead to the capacitor to prevent resonance within the power supply lines. For applications that are sensitive to jitter and noise, and when using multiple HV7351 ICs, another ferrite bead between each of the chip's supply line should be inserted.

To reduce inductance, special attention should be paid to minimizing trace lengths and using sufficient trace width. Surface mount components are highly recommended. Since the output impedance of the HV7351 high-voltage power stages is very low, in some cases it may be desirable to add a small value resistor in series with the output TX1 - TX8. This results in obtaining better waveform integrity at the load terminals after long cables and will also reduce the output voltage slew rate at the terminals of a capacitive load.

Special attention should be paid to the parasitic coupling from the outputs to the input signal terminals of the HV7351. This feedback may cause oscillations or spurious waveform shapes on the edges of signal transitions. Since the input operates with signals down to 3.3V, even small coupling voltages may cause problems. The use of a solid ground plane and good power and signal layout practices will prevent this problem.

It should also be ensured that the circulating ground return current from the capacitive load cannot react with common inductance to create noise voltages in the input circuitry.

NOTES:



MICROCHIP

**HV7351
ULTRASOUND TX BEAMFORMER
EVALUATION BOARD USER'S GUIDE**

Appendix A. Schematic and Layouts

A.1 INTRODUCTION

This appendix contains the following schematics and layouts for the HV7351 Ultrasound Tx Beamformer Evaluation Board:

- Board – Schematic
- Board – Top Layer
- Board – Top Silk Layer
- Board – Middle Layer
- Board – Bottom Layer
- Board – Bottom Silk Layer
- Board – All Layers, and Dimension

A.3 BOARD – TOP LAYER

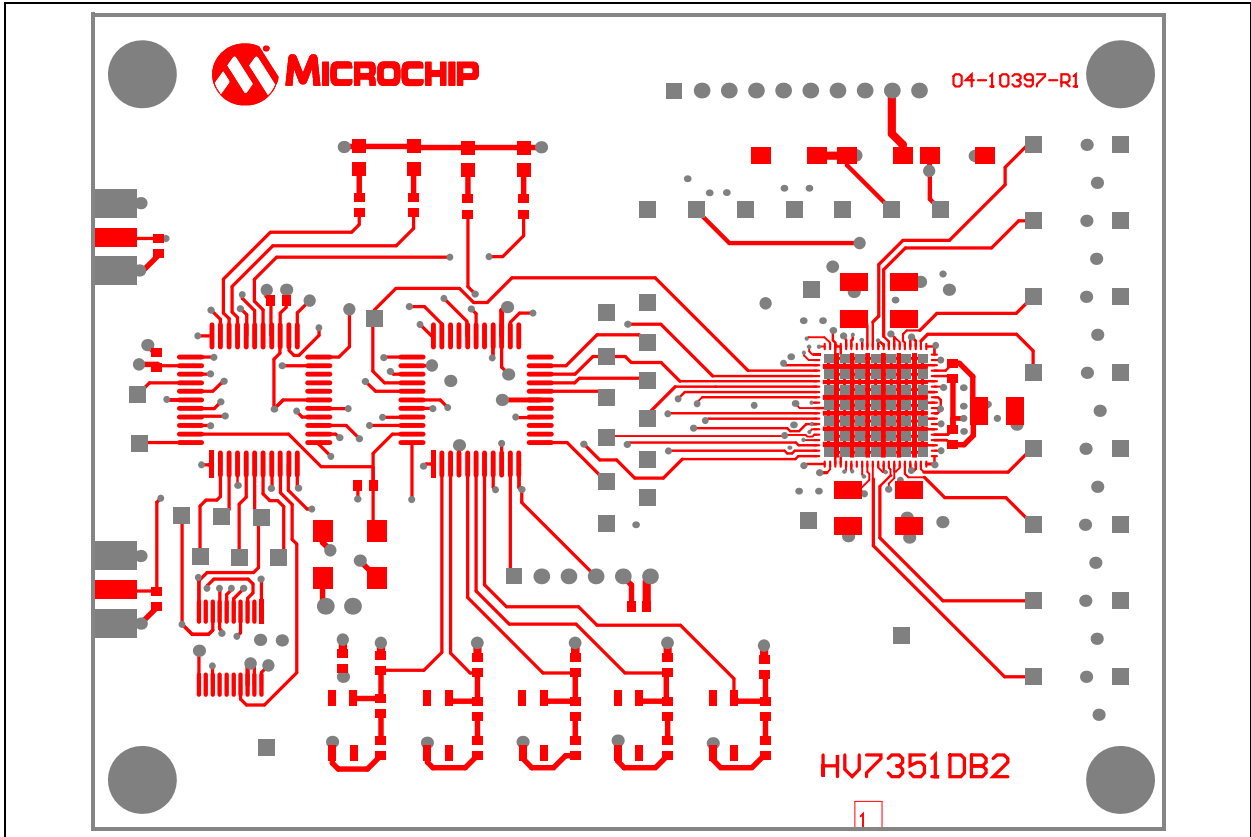

A.4 BOARD – TOP SILK LAYER

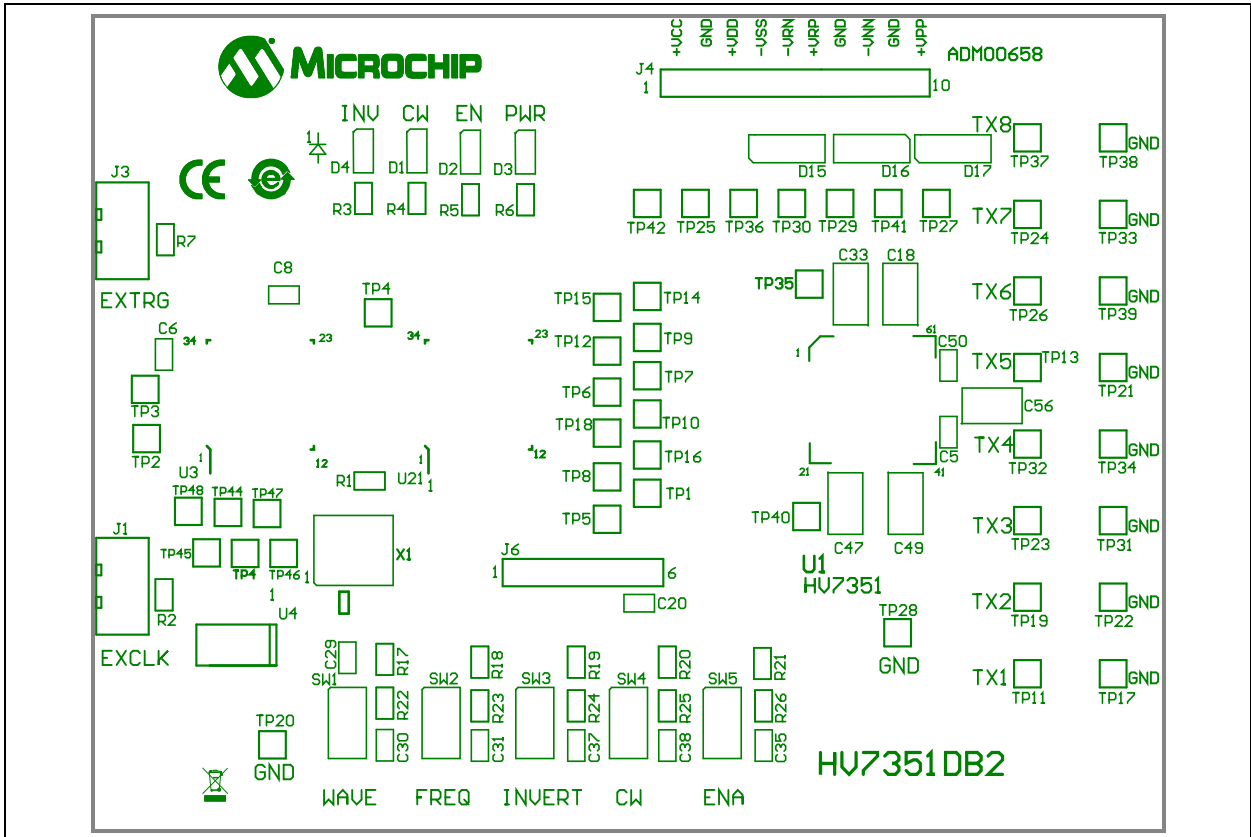

A.5 BOARD – MIDDLE LAYER

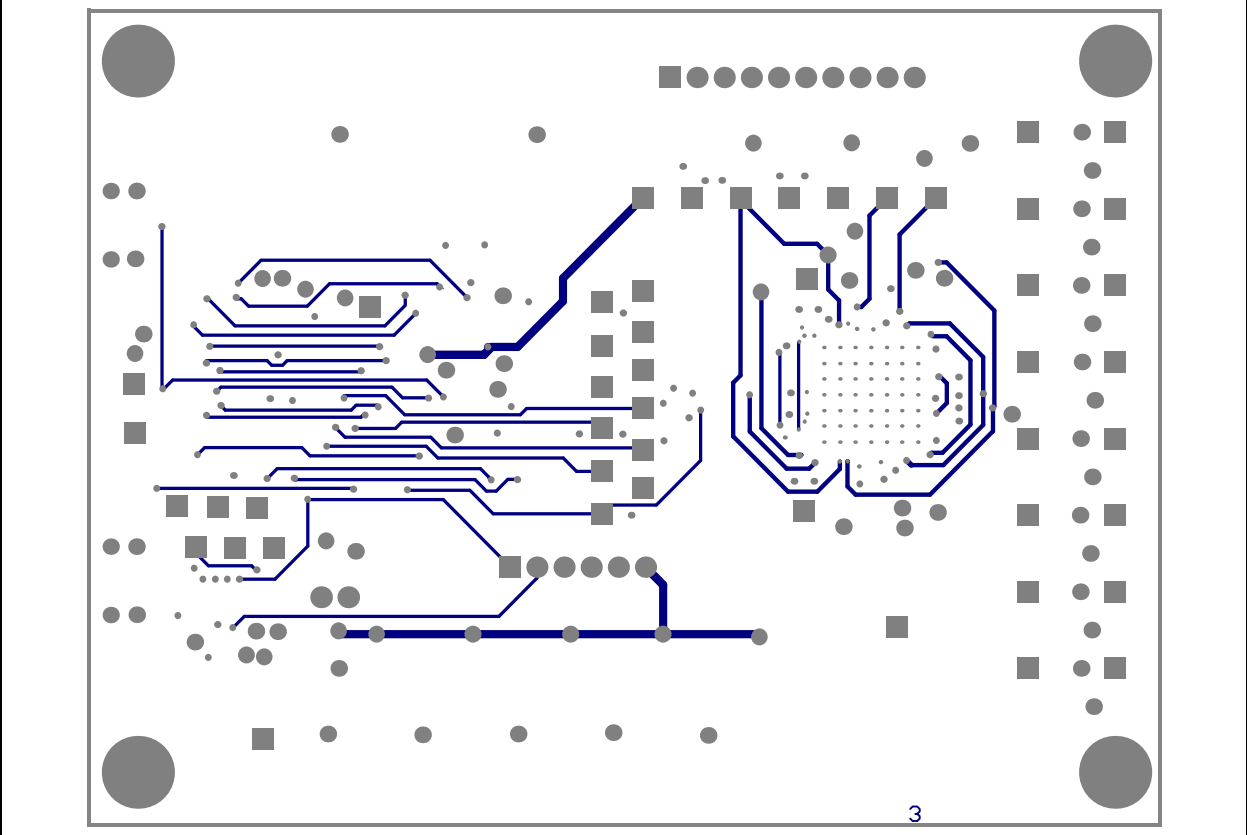

A.6 BOARD – BOTTOM LAYER

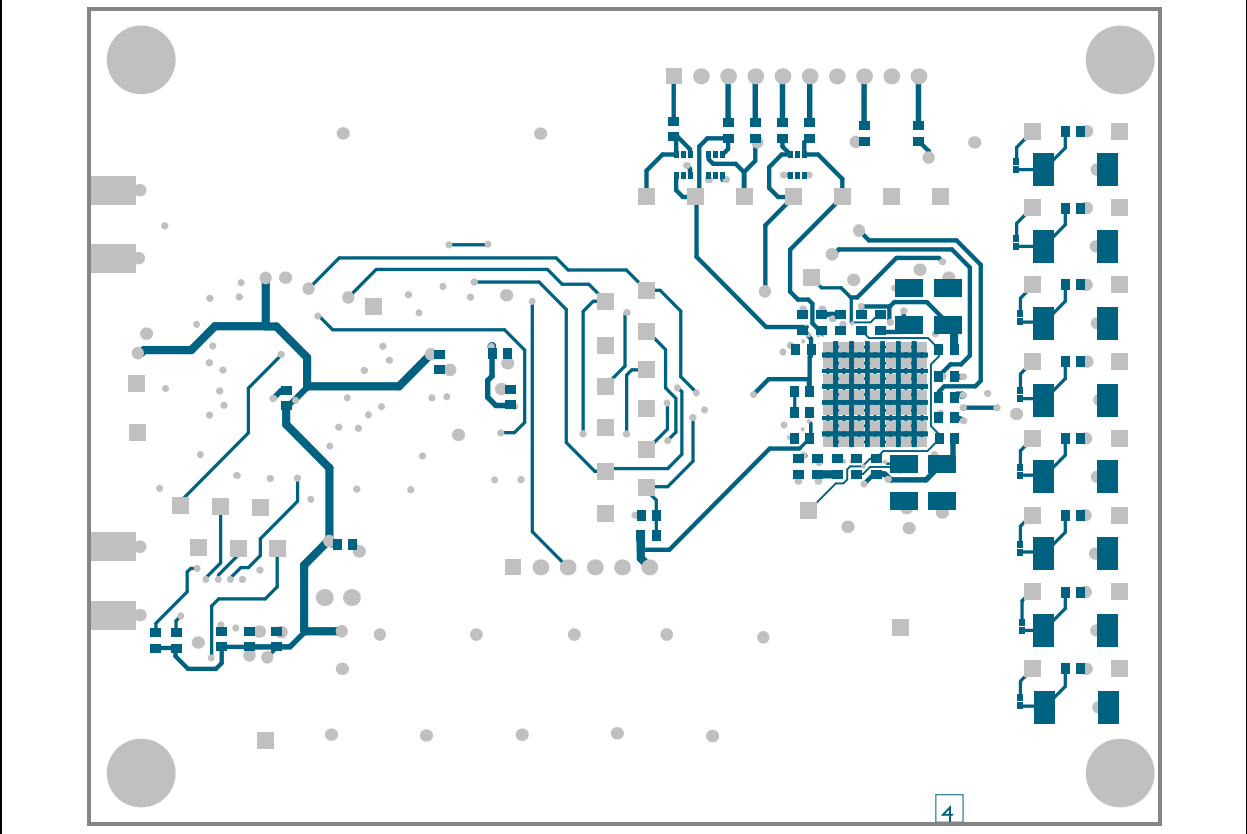

A.7 BOARD – BOTTOM SILK LAYER

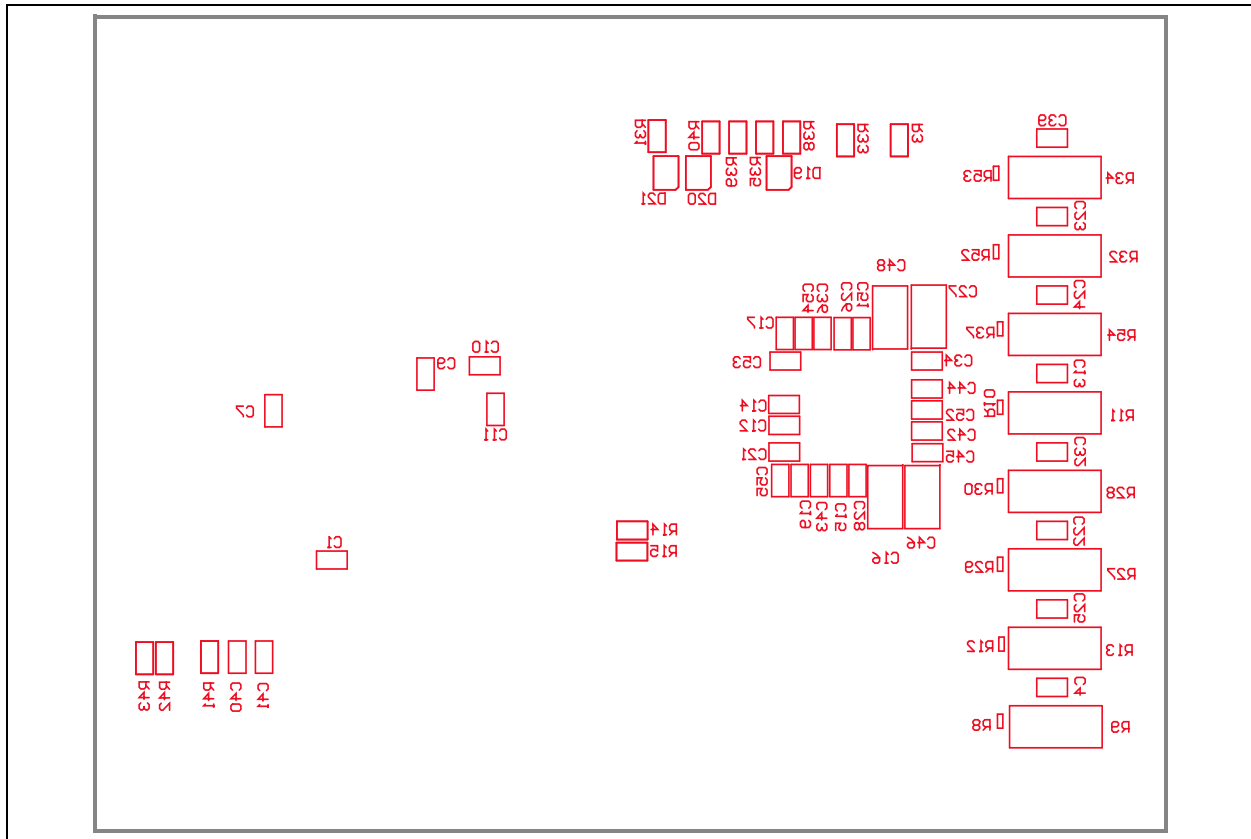

A.8 BOARD – ALL LAYERS, AND DIMENSION

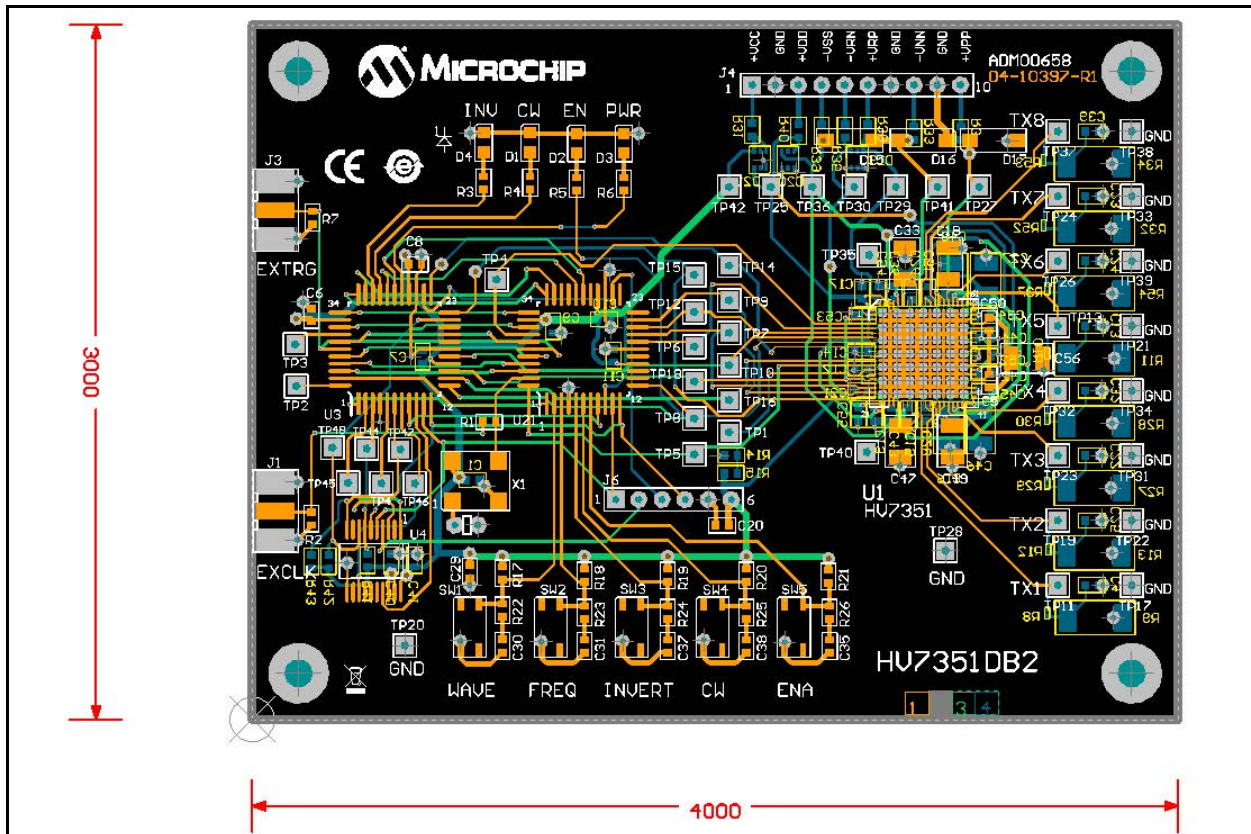

NOTES:

**MICROCHIP**

HV7351 ULTRASOUND TX BEAMFORMER EVALUATION BOARD USER'S GUIDE

Appendix B. Bill of Materials (BOM)

TABLE B-1: BILL OF MATERIALS (BOM)

Qty	Reference	Description	Manufacturer	Part Number
18	C1, 6-12, 20, 21, 29-31, 35, 37, 38, 40, 41	0.22 μ F, 10% 16V X7R ceramic capacitor	TDK Corporation	C1608X7R1C224K
8	C4,13, 22-25, 32, 39	330 pF, 200V X7R ceramic capacitor	TDK Corporation	CGJ3E3C0G2D331J080AA
19	C5, 14, 15, 17, 19, 26, 28, 34, 36, 42-45, 50-55	1 μ F, 16V X7R ceramic capacitor	TDK Corporation	C1608X7R1C105M
9	C16, 18, 27, 33, 46-49, 56	1 μ F, 20% 100V X7R ceramic capacitor	Taiyo Yuden Co., Ltd.	HMK325B7105KN-T
2	D1, D4	LED Thin 585 nm, Yellow Diff.	Lumex [®] Inc.	SML-LXT0805YW-TR
1	D2	LED Thin 635 nm, Red Diff.	Lumex Inc.	SML-LXT0805IW-TR
1	D3	LED Thin 565 nm, Green Diff.	Lumex Inc.	SML-LXT0805GW-TR
3	D15, D16, D17	100V 1A Schottky Diode	Diodes [®] Incorporated	B1100-13
3	D19, D20, D21	30V Dual Schottky Diode	Diodes Incorporated	BAT54DW-7
2	J1, J3	Connector Jack End Launch PCB Gold SM	Cinch Connectivity Solutions	142-0711-821
1	J2	Connector Header 2 POS, 100 Vert. Gold	Molex [®]	22-28-4023
1	J4	Connector Header 10 POS, 100 Vert. Gold	TE Connectivity Ltd.	1-640454-0
1	J6	Connector Header 6 POS, 100 Vert. Gold	Molex	22-28-4063
4	MH1, MH2, MH3, MH4	Screw Machine Phillips 4-40X1/4	Building Fasteners	PMS 440 0025 PH
1	PCB	HV7351 Ultrasound Tx Beamformer Evaluation Board – Printed Circuit Board	—	04-10397
7	R1, R3, R4, R5, R6, R14, R15	1 k Ω , 1/16W, 1% resistor	ROHM Semiconductor	MCR03EZP5J10
2	R2, R7	49.9 Ω , 1/16W, 1% resistor	Panasonic [®] - ECG	ERJ-3EKF49R9V
8	R8, R10, R12, R29, R30, R37, R52, R53	Solder Gap (short)	NA	NA
8	R9, R11, R13, R27, R28, R32, R34, R54	2.55 k Ω , 1W, 1% resistor	Panasonic - ECG	ERJ-1TNF2551U
5	R17, R18, R19, R20, R21	33.2 k Ω , 1/16W, 1% resistor	Panasonic - ECG	ERJ-3EKF3322V
5	R22, R23, R24, R25, R26	200 Ω , 1/16W, 1% resistor	ROHM Semiconductor	MCR03FZPEJ201

Note 1: The components listed in this Bill of Materials are representative of the PCB assembly. The released BOM used in manufacturing uses all RoHS-compliant components.

HV7351 Ultrasound Tx Beamformer Evaluation Board User's Guide

TABLE B-1: BILL OF MATERIALS (BOM) (CONTINUED)

Qty	Reference	Description	Manufacturer	Part Number
5	R31, R35, R38, R39, R40	1Ω, 1/10W, 1% resistor	Stackpole Electronics, Inc.	RNCP0603FTD1R00
2	R33,3R6	10Ω, 1/10W, 1% resistor	Stackpole Electronics, Inc.	RMCF0603JT10R0
3	R41, R42, R43	4.99 kΩ, 1/16W, 1% resistor	Panasonic - ECG	ERJ-3EKF4991V
5	SW1-SW5	Switch LT 4.7 mm X 3.5 mm 100 GF SMD	Panasonic - ECG	EVQ-P2002M
2	TP20, TP28	Test Point PC Multi-Purpose Block	Keystone Electronics Corp.	5011
1	U1	IC HV7351K6-G 8-Ch ±70V, 3A Beamformer	Microchip Technology Inc.	HV7351K6-G
2	U2, U3	IC CPLD 72 MC cell C-Temp 44-VQFP	Xilinx Inc.	XC9572XL-5VQ44C
1	U4	IC Prom IN Syst. Prg. 3.3V 20TSSOP	Xilinx Inc.	XCF01SVOG20C
1	X1	160 MHz Clock Oscillator, 3.3V SMD	Fox Electronics	FXO-HV73x-160
4	for MH1-4	Standoff Hex 4-40THR 0.25"L Alum.	Keystone Electronics Corp.	1891
1	for J2	Shunt, ECON, PHBR 5 AU, Black	TE Connectivity Ltd	382811-8

Note 1: The components listed in this Bill of Materials are representative of the PCB assembly. The released BOM used in manufacturing uses all RoHS-compliant components.



Appendix C. Plots and Waveforms

C.1 HV7351 TYPICAL WAVEFORMS

C.1.1 Four Outputs of Eight Channels, 5 MHz \pm 70V with Different Beamforming Delays, with 330 pF||2.5 k Ω Load

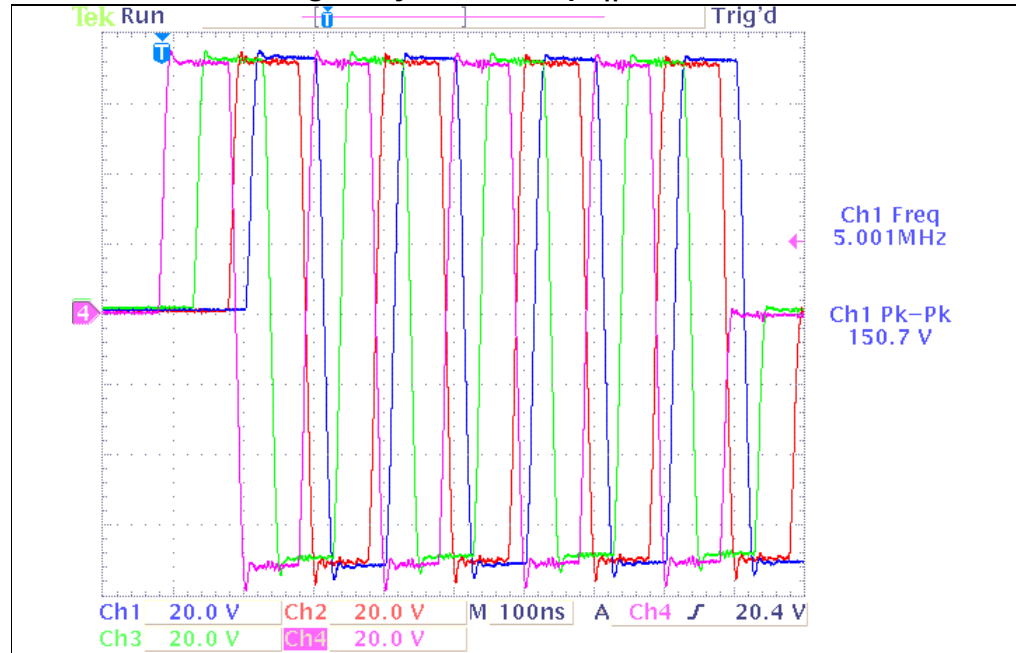

C.1.2 Tx Output at 10 MHz \pm 70V with 330 pF||2.5 k Ω Load

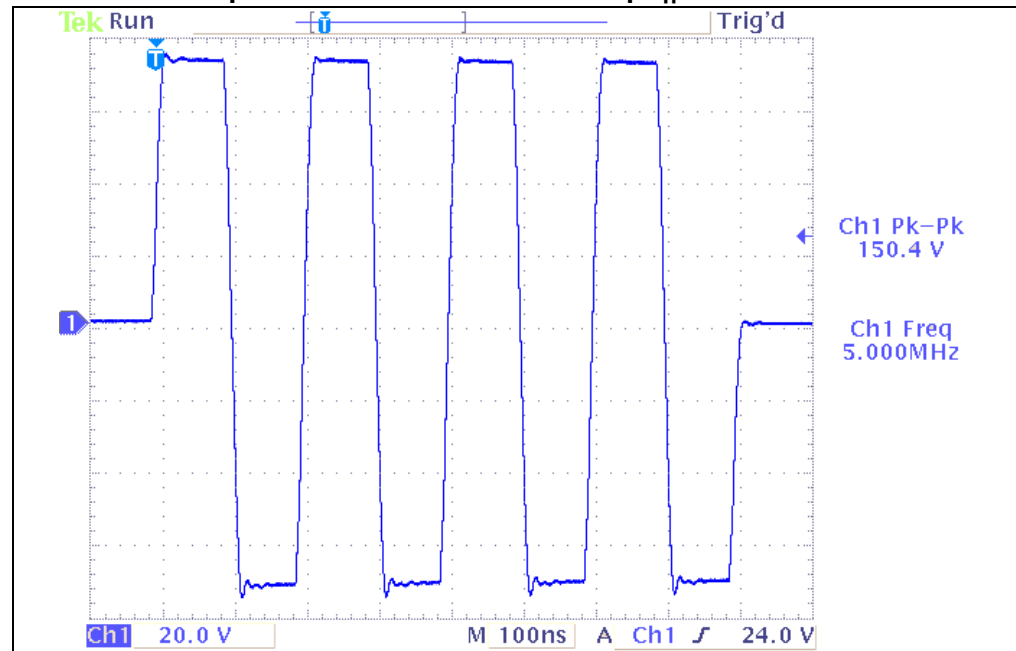

C.1.3 Tx RTZ Output at $\pm 70\text{V}$ with $330\text{ pF} \parallel 2.5\text{k}\Omega$ Load

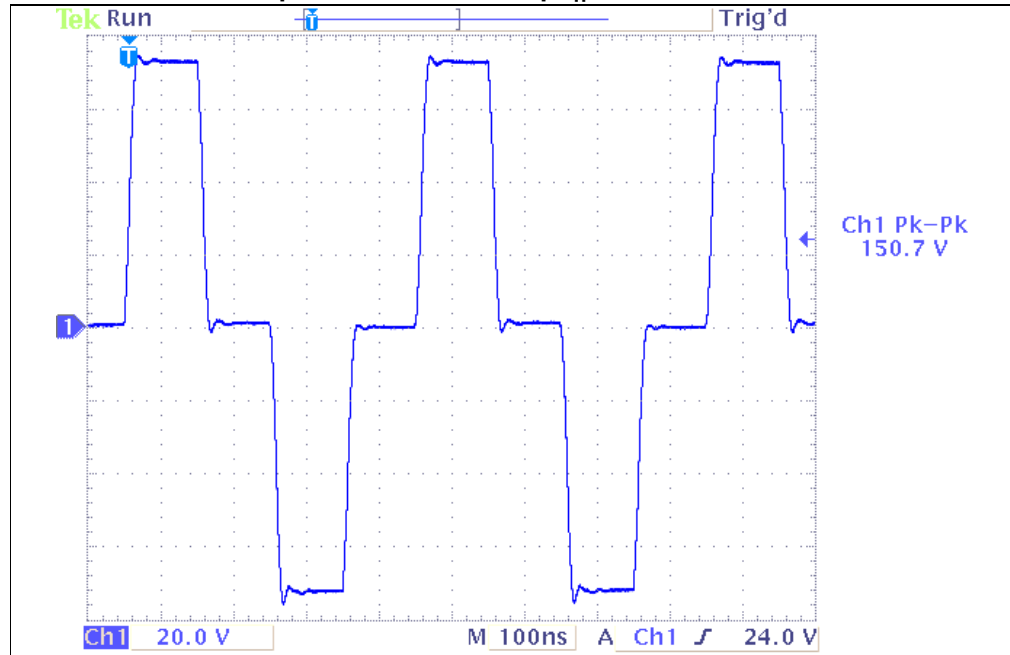

C.1.4 RTZ Output t_r/t_f Time at 0 to +70V with $330\text{ pF} \parallel 2.5\text{k}\Omega$ Load

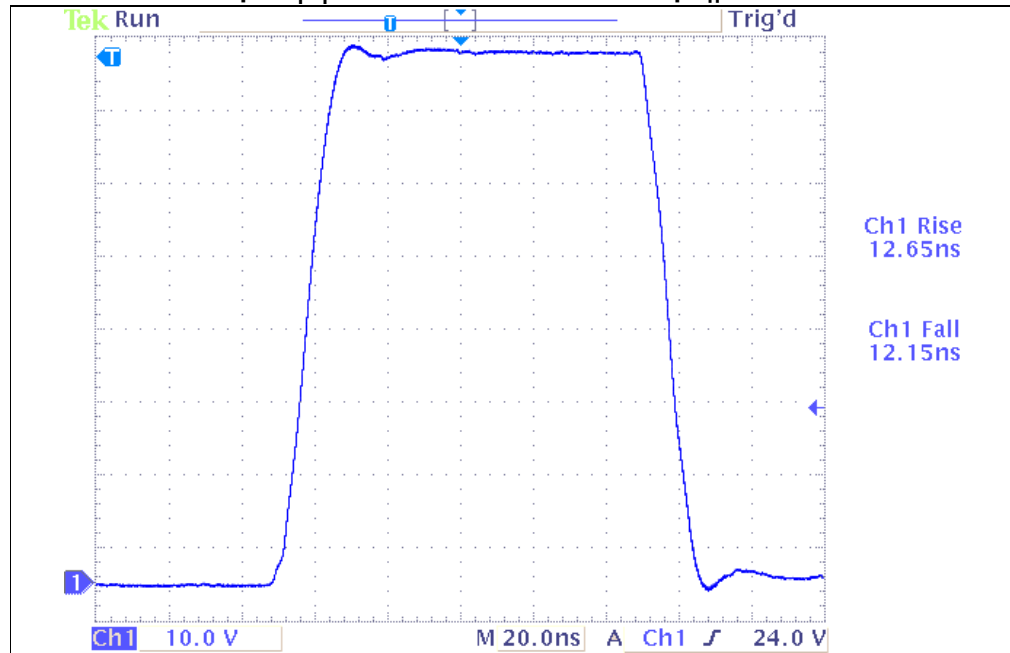

C.1.5 RTZ Output t_r/t_f Time at 0 to -70V with 330 pF||2.5 k Ω Load

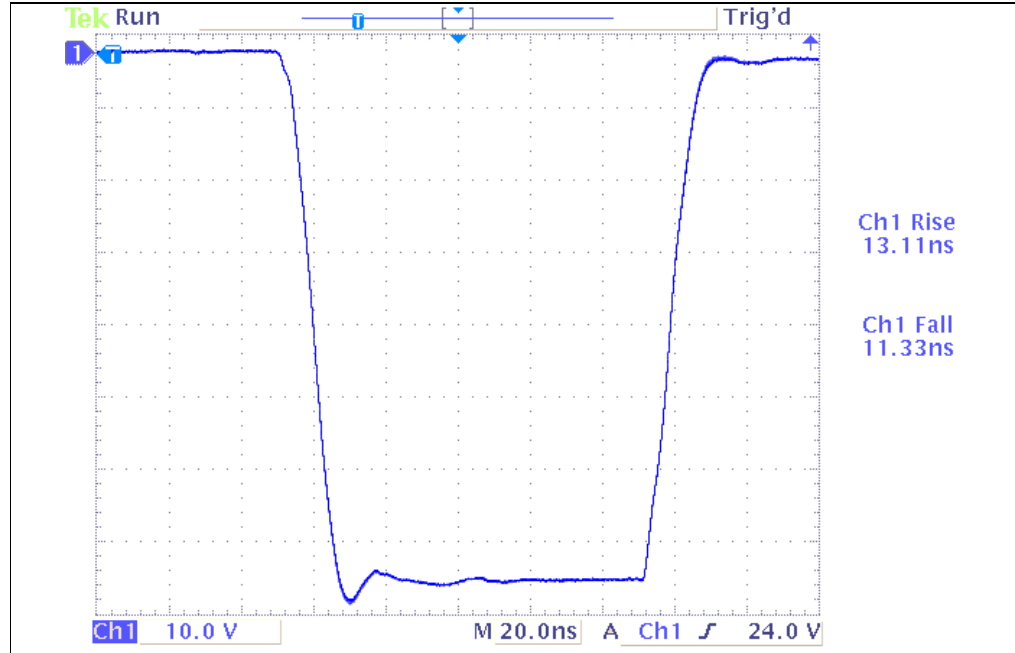

C.1.6 5 MHz t_r/t_f Time at $\pm 50V$ Output with 330 pF||2.5 k Ω Load

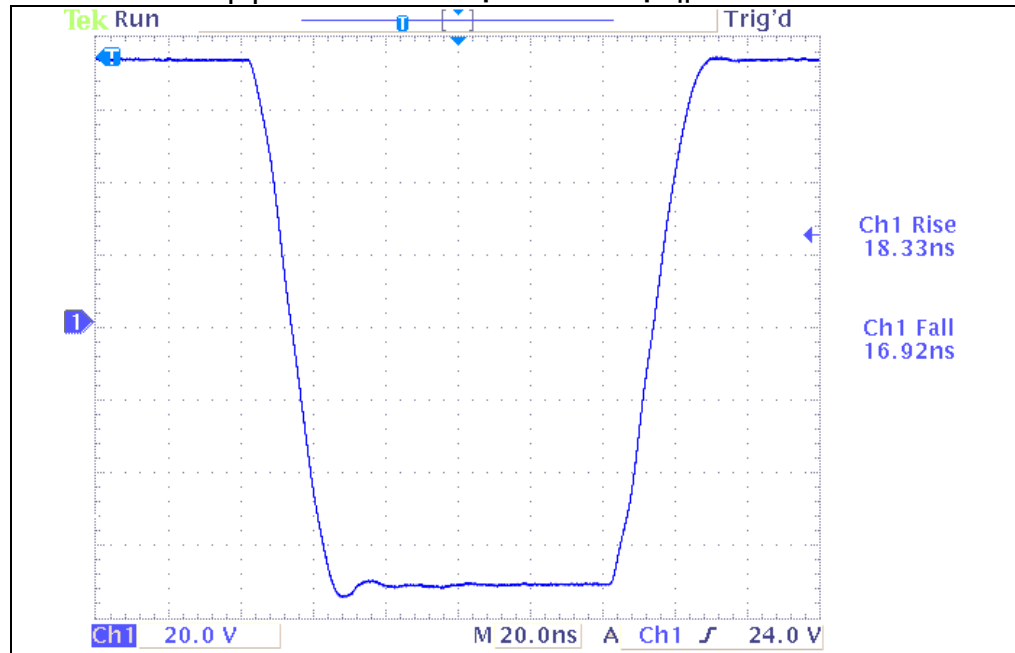

C.1.7 $\pm 50V$ 5 MHz 8-Cycle Output & HD2 with 330 pF||2.5 k Ω Load

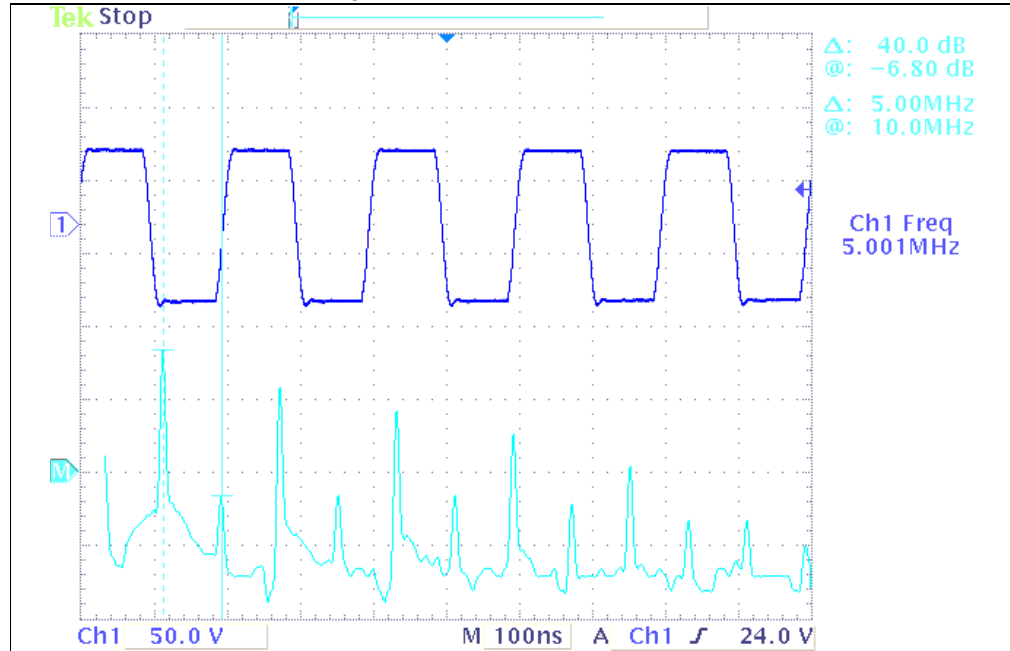

C.1.8 5 MHz $\pm 75V$ B-Mode Waveform and Flip Waveform

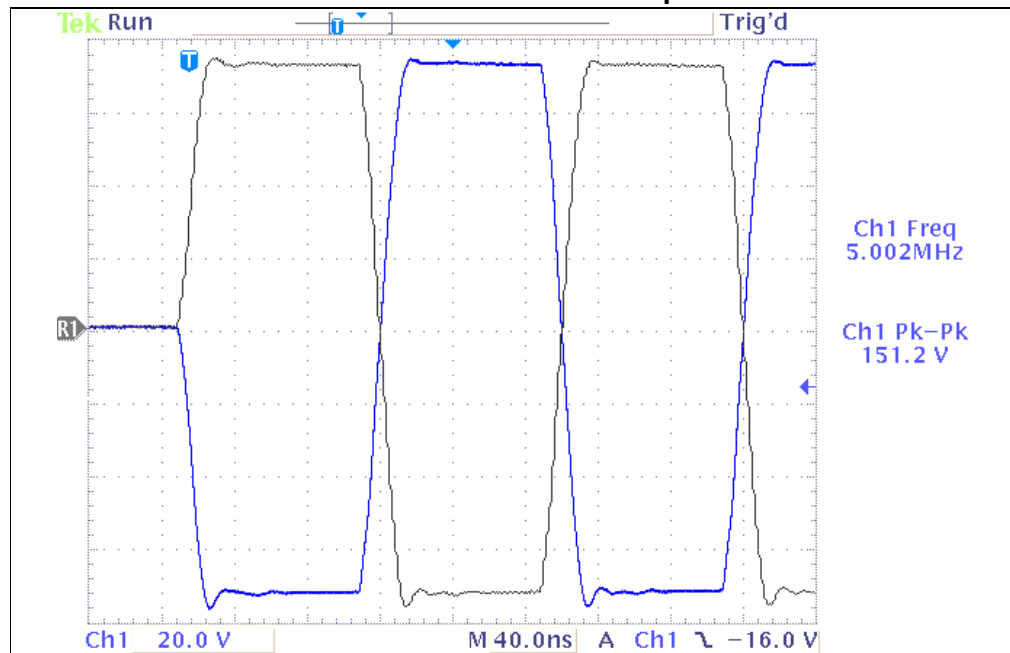

C.1.9 Four Outputs of Eight Channels, 5 MHz \pm 5.0V CW-Mode Output Waveform

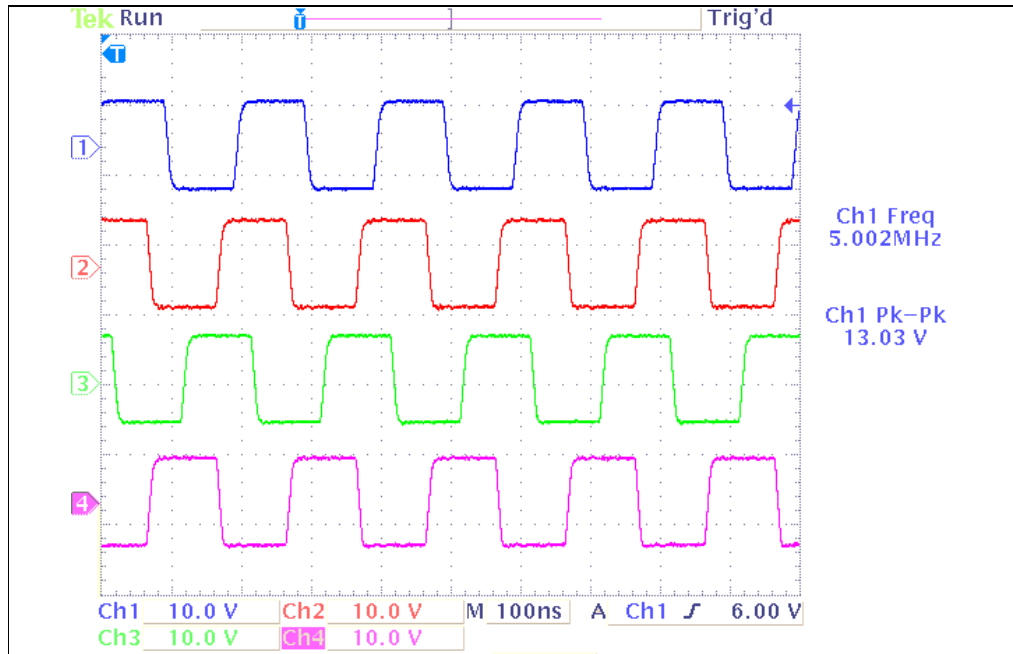



MICROCHIP

Worldwide Sales and Service

AMERICAS

Corporate Office

2355 West Chandler Blvd.
Chandler, AZ 85224-6199
Tel: 480-792-7200
Fax: 480-792-7277
Technical Support:
<http://www.microchip.com/support>

Web Address:

www.microchip.com

Atlanta

Duluth, GA
Tel: 678-957-9614
Fax: 678-957-1455

Austin, TX

Tel: 512-257-3370

Boston

Westborough, MA
Tel: 774-760-0087
Fax: 774-760-0088

Chicago

Itasca, IL
Tel: 630-285-0071
Fax: 630-285-0075

Cleveland

Independence, OH
Tel: 216-447-0464
Fax: 216-447-0643

Dallas

Addison, TX
Tel: 972-818-7423
Fax: 972-818-2924

Detroit

Novi, MI
Tel: 248-848-4000

Houston, TX

Tel: 281-894-5983

Indianapolis

Noblesville, IN
Tel: 317-773-8323
Fax: 317-773-5453

Los Angeles

Mission Viejo, CA
Tel: 949-462-9523
Fax: 949-462-9608

New York, NY

Tel: 631-435-6000

San Jose, CA

Tel: 408-735-9110

Canada - Toronto

Tel: 905-673-0699
Fax: 905-673-6509

ASIA/PACIFIC

Asia Pacific Office

Suites 3707-14, 37th Floor
Tower 6, The Gateway
Harbour City, Kowloon

Hong Kong

Tel: 852-2943-5100
Fax: 852-2401-3431

Australia - Sydney

Tel: 61-2-9868-6733
Fax: 61-2-9868-6755

China - Beijing

Tel: 86-10-8569-7000
Fax: 86-10-8528-2104

China - Chengdu

Tel: 86-28-8665-5511
Fax: 86-28-8665-7889

China - Chongqing

Tel: 86-23-8980-9588
Fax: 86-23-8980-9500

China - Dongguan

Tel: 86-769-8702-9880

China - Hangzhou

Tel: 86-571-8792-8115
Fax: 86-571-8792-8116

China - Hong Kong SAR

Tel: 852-2943-5100
Fax: 852-2401-3431

China - Nanjing

Tel: 86-25-8473-2460
Fax: 86-25-8473-2470

China - Qingdao

Tel: 86-532-8502-7355
Fax: 86-532-8502-7205

China - Shanghai

Tel: 86-21-5407-5533
Fax: 86-21-5407-5066

China - Shenyang

Tel: 86-24-2334-2829
Fax: 86-24-2334-2393

China - Shenzhen

Tel: 86-755-8864-2200
Fax: 86-755-8203-1760

China - Wuhan

Tel: 86-27-5980-5300
Fax: 86-27-5980-5118

China - Xian

Tel: 86-29-8833-7252
Fax: 86-29-8833-7256

ASIA/PACIFIC

China - Xiamen

Tel: 86-592-2388138
Fax: 86-592-2388130

China - Zhuhai

Tel: 86-756-3210040
Fax: 86-756-3210049

India - Bangalore

Tel: 91-80-3090-4444
Fax: 91-80-3090-4123

India - New Delhi

Tel: 91-11-4160-8631
Fax: 91-11-4160-8632

India - Pune

Tel: 91-20-3019-1500

Japan - Osaka

Tel: 81-6-6152-7160
Fax: 81-6-6152-9310

Japan - Tokyo

Tel: 81-3-6880-3770
Fax: 81-3-6880-3771

Korea - Daegu

Tel: 82-53-744-4301
Fax: 82-53-744-4302

Korea - Seoul

Tel: 82-2-554-7200
Fax: 82-2-558-5932 or
82-2-558-5934

Malaysia - Kuala Lumpur

Tel: 60-3-6201-9857
Fax: 60-3-6201-9859

Malaysia - Penang

Tel: 60-4-227-8870
Fax: 60-4-227-4068

Philippines - Manila

Tel: 63-2-634-9065
Fax: 63-2-634-9069

Singapore

Tel: 65-6334-8870
Fax: 65-6334-8850

Taiwan - Hsin Chu

Tel: 886-3-5778-366
Fax: 886-3-5770-955

Taiwan - Kaohsiung

Tel: 886-7-213-7828

Taiwan - Taipei

Tel: 886-2-2508-8600
Fax: 886-2-2508-0102

Thailand - Bangkok

Tel: 66-2-694-1351
Fax: 66-2-694-1350

EUROPE

Austria - Wels

Tel: 43-7242-2244-39
Fax: 43-7242-2244-393

Denmark - Copenhagen

Tel: 45-4450-2828
Fax: 45-4485-2829

France - Paris

Tel: 33-1-69-53-63-20
Fax: 33-1-69-30-90-79

Germany - Dusseldorf

Tel: 49-2129-3766400

Germany - Munich

Tel: 49-89-627-144-0
Fax: 49-89-627-144-44

Germany - Pforzheim

Tel: 49-7231-424750

Italy - Milan

Tel: 39-0331-742611
Fax: 39-0331-466781

Italy - Venice

Tel: 39-049-7625286

Netherlands - Drunen

Tel: 31-416-690399
Fax: 31-416-690340

Poland - Warsaw

Tel: 48-22-3325737

Spain - Madrid

Tel: 34-91-708-08-90
Fax: 34-91-708-08-91

Sweden - Stockholm

Tel: 46-8-5090-4654

UK - Wokingham

Tel: 44-118-921-5800
Fax: 44-118-921-5820

01/27/15

Компания «Океан Электроники» предлагает заключение долгосрочных отношений при поставках импортных электронных компонентов на взаимовыгодных условиях!

Наши преимущества:

- Поставка оригинальных импортных электронных компонентов напрямую с производств Америки, Европы и Азии, а так же с крупнейших складов мира;
- Широкая линейка поставок активных и пассивных импортных электронных компонентов (более 30 млн. наименований);
- Поставка сложных, дефицитных, либо снятых с производства позиций;
- Оперативные сроки поставки под заказ (от 5 рабочих дней);
- Экспресс доставка в любую точку России;
- Помощь Конструкторского Отдела и консультации квалифицированных инженеров;
- Техническая поддержка проекта, помощь в подборе аналогов, поставка прототипов;
- Поставка электронных компонентов под контролем ВП;
- Система менеджмента качества сертифицирована по Международному стандарту ISO 9001;
- При необходимости вся продукция военного и аэрокосмического назначения проходит испытания и сертификацию в лаборатории (по согласованию с заказчиком);
- Поставка специализированных компонентов военного и аэрокосмического уровня качества (Xilinx, Altera, Analog Devices, Intersil, Interpoint, Microsemi, Actel, Aeroflex, Peregrine, VPT, Syfer, Eurofarad, Texas Instruments, MS Kennedy, Miteq, Cobham, E2V, MA-COM, Hittite, Mini-Circuits, General Dynamics и др.);

Компания «Океан Электроники» является официальным дистрибьютором и эксклюзивным представителем в России одного из крупнейших производителей разъемов военного и аэрокосмического назначения «**JONHON**», а так же официальным дистрибьютором и эксклюзивным представителем в России производителя высокотехнологичных и надежных решений для передачи СВЧ сигналов «**FORSTAR**».



JONHON

«**JONHON**» (основан в 1970 г.)

Разъемы специального, военного и аэрокосмического назначения:

(Применяются в военной, авиационной, аэрокосмической, морской, железнодорожной, горно- и нефтедобывающей отраслях промышленности)

«**FORSTAR**» (основан в 1998 г.)

ВЧ соединители, коаксиальные кабели,
кабельные сборки и микроволновые компоненты:

(Применяются в телекоммуникациях гражданского и специального назначения, в средствах связи, РЛС, а так же военной, авиационной и аэрокосмической отраслях промышленности).



Телефон: 8 (812) 309-75-97 (многоканальный)

Факс: 8 (812) 320-03-32

Электронная почта: ocean@oceanchips.ru

Web: <http://oceanchips.ru/>

Адрес: 198099, г. Санкт-Петербург, ул. Калинина, д. 2, корп. 4, лит. А