

18V, 3A SYNCHRONOUS DC-DC BUCK CONVERTER

NEW PRODUCT

Description

The AP3513E is a 500kHz fixed frequency, current mode, PWM synchronous buck (step-down) DC-DC converter, capable of driving a 3A load with high efficiency, excellent line and load regulation. The AP3513E exhibits high efficiency at light load. The device integrates N-channel power MOSFET switch with low on-resistance. Current mode control provides fast transient response and cycle-by-cycle current limit.

The AP3513E employs complete protection to ensure system security, including output Over Voltage Protection, input Under Voltage Lock Out, programmable Soft-start, Over Temperature Protection and hiccup mode Short Circuit Protection.

This IC is available in SO-8EP package.

Features

- Input Voltage Range: 4.5V to 18V
- Fixed 500kHz Frequency
- High Efficiency at Light Load
- Output Current: 3A
- Current Mode Control
- Built-in Over Current Protection
- Built-in Thermal Shutdown Function
- Built-in UVLO Function
- Built-in Over Voltage Protection
- Programmable Soft-start
- Hiccup Mode SCP
- **Totally Lead-Free & Fully RoHS Compliant (Notes 1 & 2)**
- **Halogen and Antimony Free. "Green" Device (Note 3)**

Pin Assignments

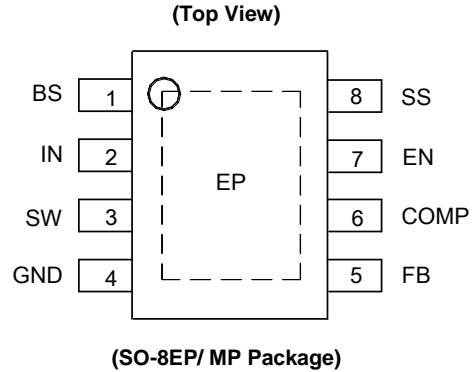

Applications

- Monitor
- TV
- STB
- Datacom

Notes: 1. No purposely added lead. Fully EU Directive 2002/95/EC (RoHS) & 2011/65/EU (RoHS 2) compliant.
 2. See http://www.diodes.com/quality/lead_free.html for more information about Diodes Incorporated's definitions of Halogen- and Antimony-free, "Green" and Lead-free.
 3. Halogen- and Antimony-free "Green" products are defined as those which contain <900ppm bromine, <900ppm chlorine (<1500ppm total Br + Cl) and <1000ppm antimony compounds.

Typical Applications Circuit

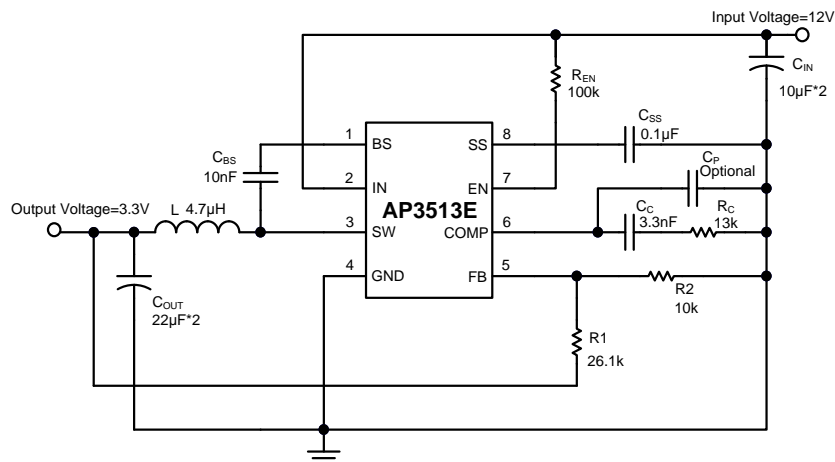

Pin Descriptions

Pin Number	Pin Name	Function
1	BS	Bootstrap pin. A bootstrap capacitor is connected between the BS pin and SW pin. The voltage across the bootstrap capacitor drives the internal high-side NMOS switch.
2	IN	Supply input pin. A capacitor should be connected between the IN pin and GND pin to keep the DC input voltage constant.
3	SW	Power switch output pin. This pin is connected to the inductor and bootstrap capacitor.
4	GND	Ground pin
5	FB	Feedback pin. This pin is connected to an external resistor divider to program the system output voltage. When the FB pin voltage exceeds 1.1V, the over voltage protection is triggered. When the FB pin voltage is below 0.3V, the oscillator frequency is lowered to realize short circuit protection.
6	COMP	Compensation pin. This pin is the output of the transconductance error amplifier and the input to the current comparator. This pin is used to compensate the control loop. Connect a series RC network from this pin to GND pin. In some cases, an additional capacitor from this pin to GND pin is required.
7	EN	Enable Input. EN is a digital input that turns the regulator on or off. Drive EN high to turn on the regulator, drive it low to turn off. Pull up with 100kΩ resistor for automatic startup.
8	SS	Soft-start control input pin. SS controls the soft start period. Connect a capacitor from SS to GND to set the soft-start period. A 0.1μF capacitor sets the soft-start period to 15ms. To disable the soft-start feature, leave SS unconnected.
-	EP	Exposed pad. It should be connected to GND in PCB layout.

NEW PRODUCT

Functional Block Diagram

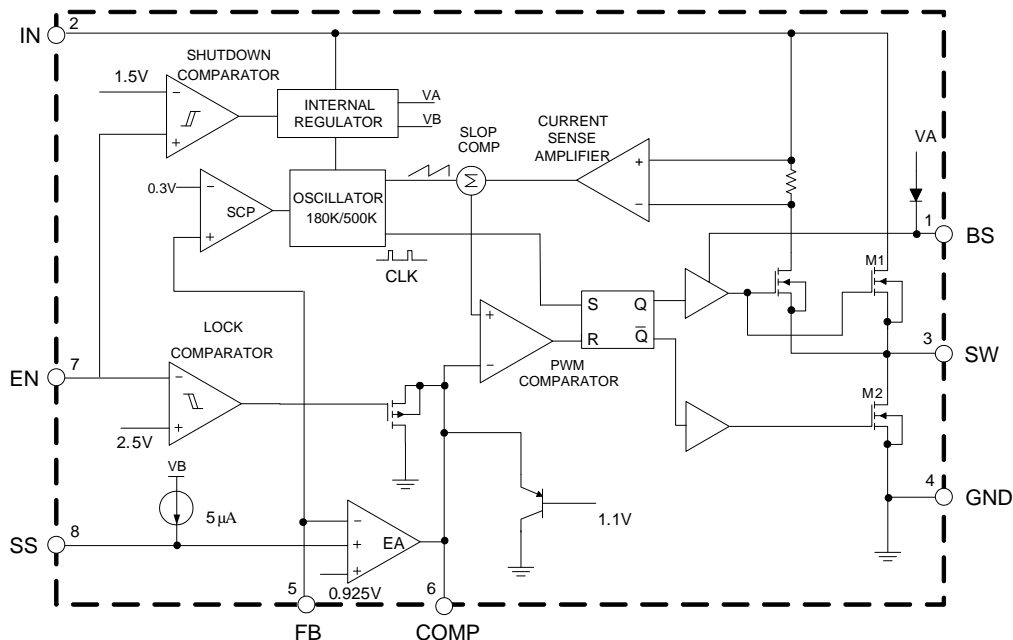

Absolute Maximum Ratings (Note 4)

Symbol	Parameter	Rating		Unit
V_{IN}	IN Pin Voltage	-0.3 to 20		V
V_{EN}	EN Pin Voltage	-0.3 to V_{IN}		V
V_{SW}	SW Pin Voltage	21		V
V_{BS}	BS Pin Voltage	-0.3 to $V_{SW}+6$		V
V_{FB}	FB Pin Voltage	-0.3 to 6		V
V_{COMP}	COMP Pin Voltage	-0.3 to 6		V
V_{SS}	SS Pin Voltage	-0.3 to 6		V
T_J	Operating Junction Temperature	+150		°C
T_{STG}	Storage Temperature	-65 to +150		°C
T_{LEAD}	Lead Temperature (Soldering, 10sec)	+260		°C
θ_{JA}	Thermal Resistance (Junction to Ambient)	SO-8EP	60	°C/W
V_{HBM}	ESD (Human Body Model)	2000		V
V_{MM}	ESD (Machine Model)	200		V

Note 4: Stresses greater than those listed under "Absolute Maximum Ratings" may cause permanent damage to the device. These are stress ratings only, and functional operation of the device at these or any other conditions beyond those indicated under "Recommended Operating Conditions" is not implied. Exposure to "Absolute Maximum Ratings" for extended periods may affect device reliability.

Recommended Operating Conditions

Symbol	Parameter	Min	Max	Unit
V_{IN}	Input Voltage	4.5	18	V
T_A	Operating Ambient Temperature	-40	+85	°C

Electrical Characteristics ($V_{IN} = V_{EN} = 12V$, $V_{OUT} = 3.3V$, $T_A = +25^\circ C$, unless otherwise specified.)

Symbol	Parameter	Conditions	Min	Typ	Max	Unit
SUPPLY VOLTAGE (IN PIN)						
V_{IN}	Input Voltage	–	4.5	–	18	V
I_Q	Quiescent Current	$V_{FB} = 1V$, $V_{EN} = 3.3V$	–	1.2	1.4	mA
I_{SHDN}	Shutdown Supply Current	$V_{EN} = 0V$	–	0.1	1.0	μA
UNDER VOLTAGE LOCKOUT						
V_{UVLO}	Input UVLO Threshold	V_{IN} Rising	3.65	4.0	4.25	V
V_{HYS}	Input UVLO Hysteresis	–	–	0.2	–	V
ENABLE (EN PIN)						
–	EN Shutdown Threshold Voltage	–	1.1	1.5	2	V
–	EN Shutdown Threshold Voltage Hysteresis (Note 5)	–	–	350	–	mV
–	EN Lockout Threshold Voltage	–	2.2	2.5	2.7	V
–	EN Lockout Hysteresis	–	–	210	–	mV
VOLTAGE REFERENCE (FB PIN)						
V_{FB}	Feedback Voltage	–	0.907	0.925	0.943	V
V_{FBOV}	Feedback Over Voltage Threshold	–	–	1.1	–	V
I_{FB}	Feedback Bias Current	$V_{FB} = 1V$	-0.1	–	0.1	μA
MOSFET						
R_{DSONH}	High-side Switch On-resistance (Note 6)	$I_{SW} = 0.2A \& 0.7A$	–	100	–	m Ω
R_{DSONL}	Low-side Switch On-resistance (Note 6)	$I_{SW} = -0.2A \& -0.7A$	–	100	–	m Ω
CURRENT LIMIT						
I_{LEAKH}	High-side Switch Leakage Current	$V_{IN} = 18V$, $V_{EN} = 0V$, $V_{SW} = 0V$	–	0.1	10	μA
I_{LIMH}	High-side Switch Current Limit	–	4.3	5.6	–	A
I_{LIML}	Low-side Switch Current Limit	From drain to source	–	50	–	mA
SWITCHING REGULATOR						
f_{OSC1}	Oscillator Frequency	–	410	500	590	kHz
f_{OSC2}	Short Circuit Oscillator Frequency	–	–	180	–	kHz
D_{MAX}	Max. Duty Cycle	$V_{FB} = 0.85V$	–	90	–	%
D_{MIN}	Min. Duty Cycle	$V_{FB} = 1V$	–	–	0	%

Electrical Characteristics (Cont. $V_{IN} = V_{EN} = 12V$, $V_{OUT} = 3.3V$, $T_A = +25^\circ C$, unless otherwise specified.)

Symbol	Parameter	Conditions	Min	Typ	Max	Unit
ERROR AMPLIFIER						
A_{EA}	Error Amplifier Voltage Gain (Note 5)	–	–	400	–	V/V
G_{EA}	Error Amplifier Transconductance	–	–	800	–	$\mu A/V$
G_{CS}	COMP to Current Sense Transconductance	–	–	5.2	–	A/V
THERMAL SHUTDOWN						
T_{OTSD}	Thermal Shutdown (Note 5)	–	–	+160	–	$^\circ C$
T_{HYS}	Thermal Shutdown Hysteresis (Note 5)	–	–	+30	–	$^\circ C$
SOFT START (SS PIN)						
t_{SS}	Soft-start Time (Note 5)	$C_{SS} = 0.1\mu F$	–	15	–	ms
–	Soft-start Current	–	–	5	–	μA

Notes: 5. Not tested, guaranteed by design.

$$6. R_{DS(on)} = \frac{V_{SW1} - V_{SW2}}{I_{SW1} - I_{SW2}}$$

Performance Characteristics ($V_{IN} = 12V$, $V_{OUT} = 3.3V$, $L = 4.7\mu H$, $T_A = +25^\circ C$, unless otherwise noted.)

Efficiency vs. Output Current

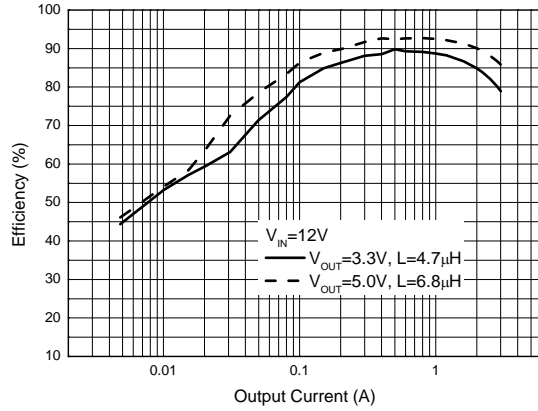

Quiescent Current vs. Temperature

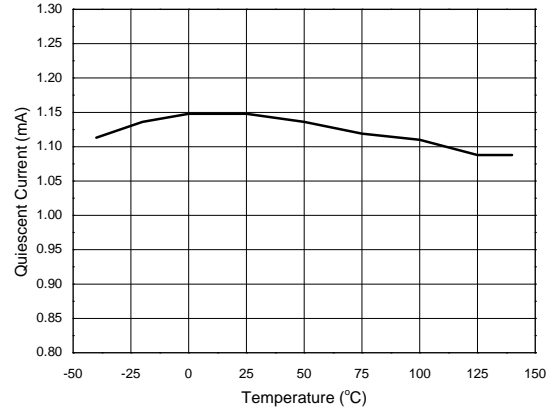

Feedback Voltage vs. Temperature

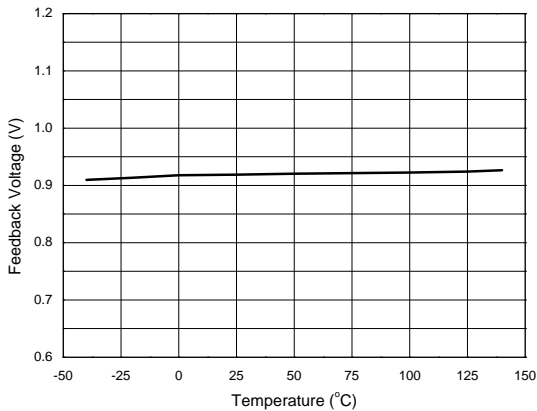

Output Ripple ($I_{OUT} = 2.5A$)

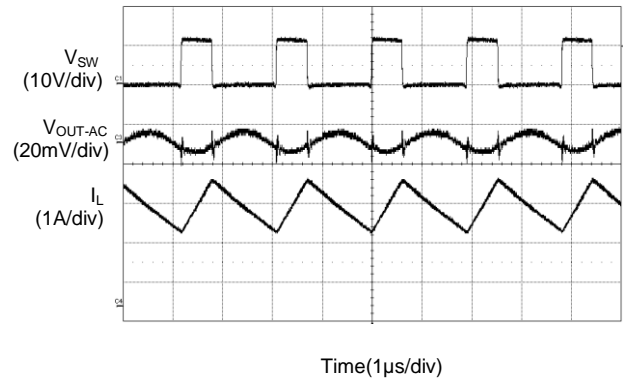

Load Transient Response ($I_{OUT} = 0.2A$ to $2.5A$)

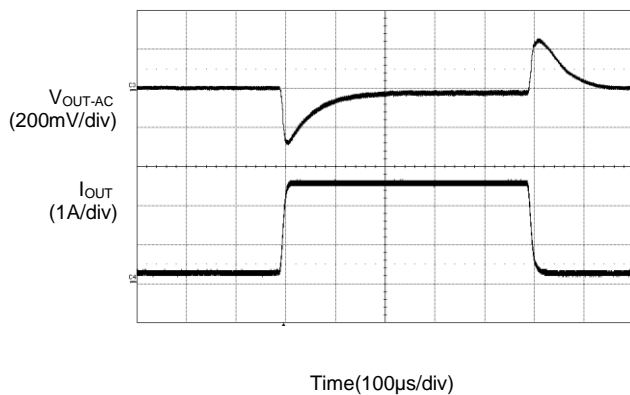

Load Transient Response ($I_{OUT} = 1A$ to $2.5A$)

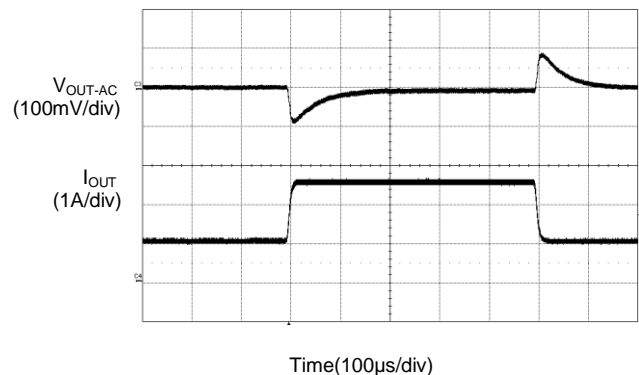

Performance Characteristics (Cont. $V_{IN} = 12V$, $V_{OUT} = 3.3V$, $L = 4.7\mu H$, $T_A = +25^\circ C$, unless otherwise noted.)

Power On from VIN ($I_{OUT} = 2.5A$)

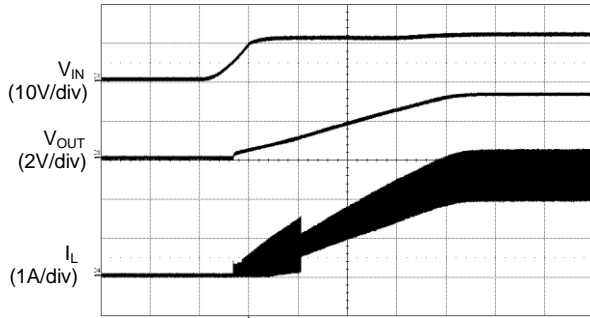

Time(3.20ms/div)

Power Off from VIN ($I_{OUT} = 2.5A$)

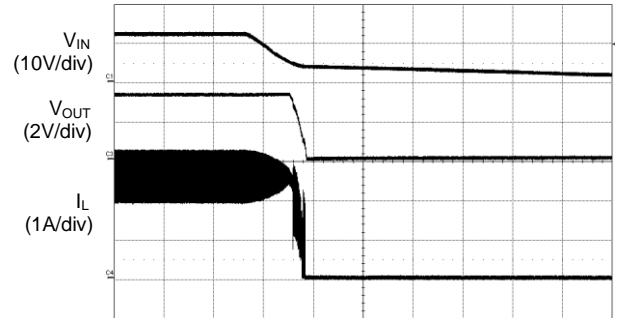

Time(3.20ms/div)

Power On from EN ($I_{OUT} = 2.5A$)

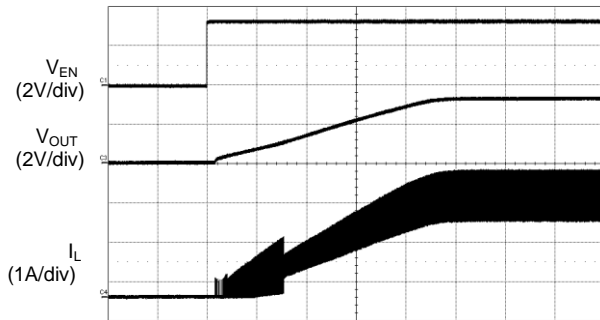

Time(3.20ms/div)

Power Off from EN ($I_{OUT} = 2.5A$)

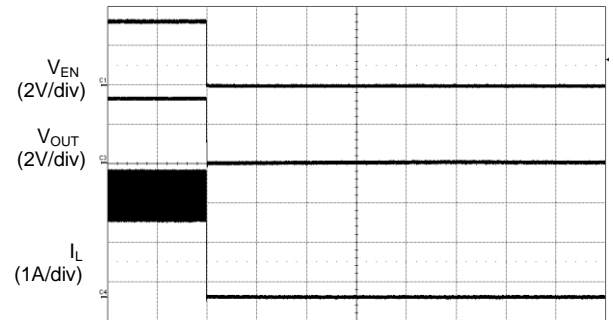

Time(3.20ms/div)

Short Circuit Protection ($I_{OUT} = 2.5A$)

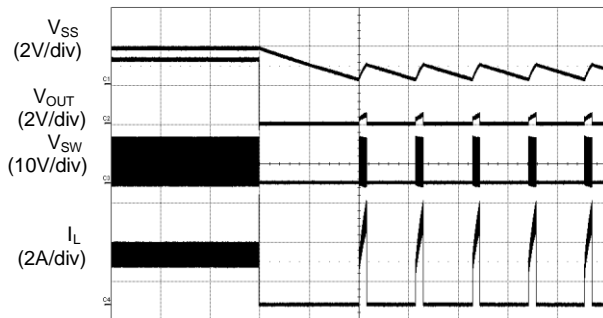

Time(64ms/div)

Short Circuit Protection Recovery ($I_{OUT} = 2.5A$)

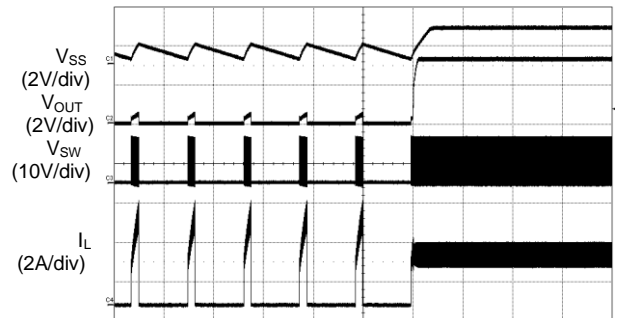

Time(64ms/div)

NEW PRODUCT

Ordering Information

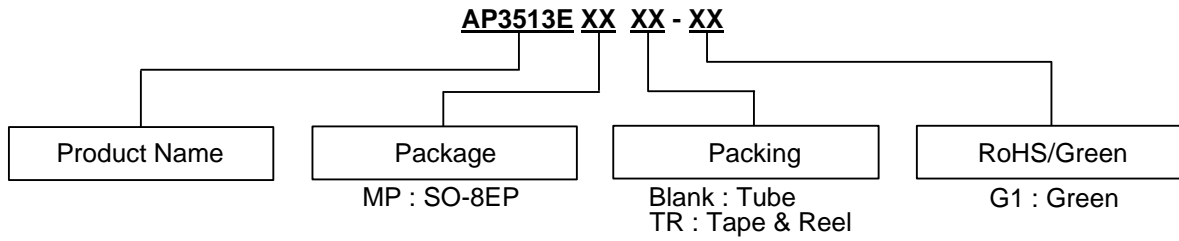

Diodes IC's Pb-free products with "G1" suffix in the part number, are RoHS compliant and green.

Package	Temperature Range	Part Number	Marking ID	Packing
SO-8EP	-40 to +85°C	AP3513EMP-G1	3513EMP-G1	100/Tube
		AP3513EMPTR-G1	3513EMP-G1	4000/Tape & Reel

Marking Information

(1) SO-8EP

(Top View)

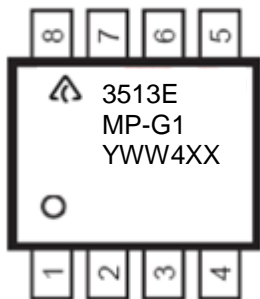

First and Second Lines: Logo and Marking ID
 Third Line: Date Code
 Y: Year
 WW: Work Week of Molding
 4: Assembly Site Code
 XX: 7th and 8th digits of Batch Number

Package Outline Dimensions (All dimensions in mm(inch).)

(1) Package Type: SO-8EP

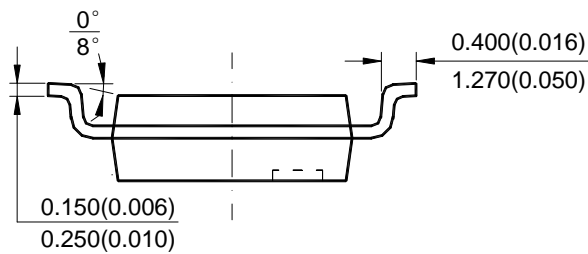
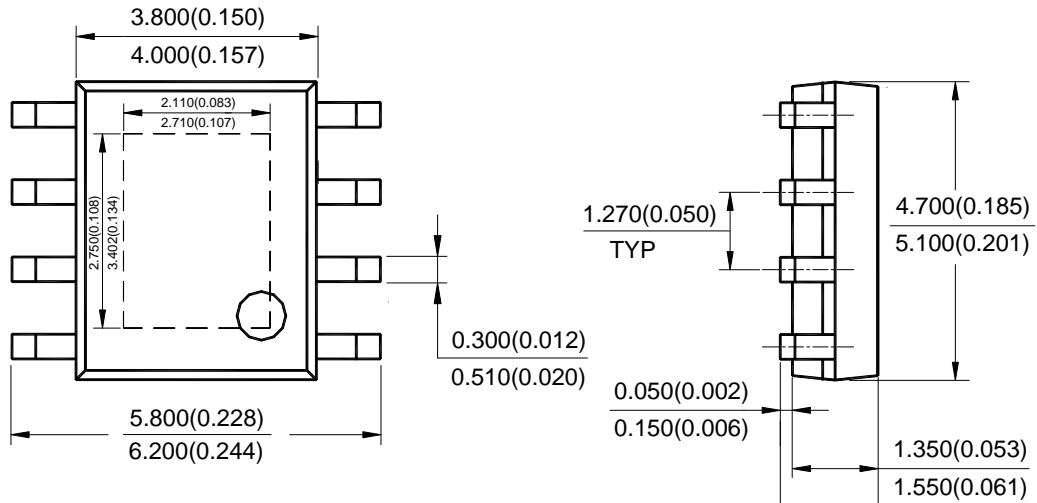

Note: Eject hole, oriented hole and mold mark is optional.

NEW PRODUCT

Suggested Pad Layout

(1) Package Type: SO-8EP

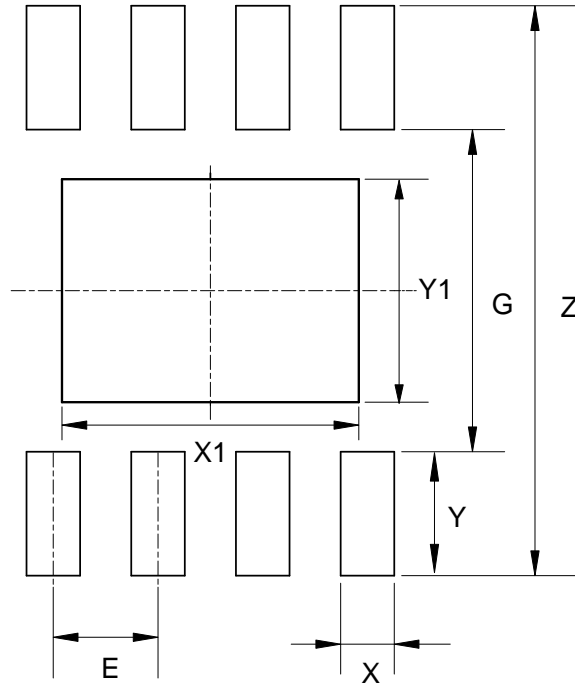

Dimensions	Z (mm)/(inch)	G (mm)/(inch)	X (mm)/(inch)	Y (mm)/(inch)
Value	6.900/0.272	3.900/0.154	0.650/0.026	1.500/0.059
Dimensions	X1 (mm)/(inch)	Y1 (mm)/(inch)	E (mm)/(inch)	---
Value	3.600/0.142	2.700/0.106	1.270/0.050	---

IMPORTANT NOTICE

DIODES INCORPORATED MAKES NO WARRANTY OF ANY KIND, EXPRESS OR IMPLIED, WITH REGARDS TO THIS DOCUMENT, INCLUDING, BUT NOT LIMITED TO, THE IMPLIED WARRANTIES OF MERCHANTABILITY AND FITNESS FOR A PARTICULAR PURPOSE (AND THEIR EQUIVALENTS UNDER THE LAWS OF ANY JURISDICTION).

Diodes Incorporated and its subsidiaries reserve the right to make modifications, enhancements, improvements, corrections or other changes without further notice to this document and any product described herein. Diodes Incorporated does not assume any liability arising out of the application or use of this document or any product described herein; neither does Diodes Incorporated convey any license under its patent or trademark rights, nor the rights of others. Any Customer or user of this document or products described herein in such applications shall assume all risks of such use and will agree to hold Diodes Incorporated and all the companies whose products are represented on Diodes Incorporated website, harmless against all damages.

Diodes Incorporated does not warrant or accept any liability whatsoever in respect of any products purchased through unauthorized sales channel. Should Customers purchase or use Diodes Incorporated products for any unintended or unauthorized application, Customers shall indemnify and hold Diodes Incorporated and its representatives harmless against all claims, damages, expenses, and attorney fees arising out of, directly or indirectly, any claim of personal injury or death associated with such unintended or unauthorized application.

Products described herein may be covered by one or more United States, international or foreign patents pending. Product names and markings noted herein may also be covered by one or more United States, international or foreign trademarks.

This document is written in English but may be translated into multiple languages for reference. Only the English version of this document is the final and determinative format released by Diodes Incorporated.

LIFE SUPPORT

Diodes Incorporated products are specifically not authorized for use as critical components in life support devices or systems without the express written approval of the Chief Executive Officer of Diodes Incorporated. As used herein:

A. Life support devices or systems are devices or systems which:

1. are intended to implant into the body, or
2. support or sustain life and whose failure to perform when properly used in accordance with instructions for use provided in the labeling can be reasonably expected to result in significant injury to the user.

B. A critical component is any component in a life support device or system whose failure to perform can be reasonably expected to cause the failure of the life support device or to affect its safety or effectiveness.

Customers represent that they have all necessary expertise in the safety and regulatory ramifications of their life support devices or systems, and acknowledge and agree that they are solely responsible for all legal, regulatory and safety-related requirements concerning their products and any use of Diodes Incorporated products in such safety-critical, life support devices or systems, notwithstanding any devices- or systems-related information or support that may be provided by Diodes Incorporated. Further, Customers must fully indemnify Diodes Incorporated and its representatives against any damages arising out of the use of Diodes Incorporated products in such safety-critical, life support devices or systems.

Copyright © 2012, Diodes Incorporated

www.diodes.com

Компания «Океан Электроники» предлагает заключение долгосрочных отношений при поставках импортных электронных компонентов на взаимовыгодных условиях!

Наши преимущества:

- Поставка оригинальных импортных электронных компонентов напрямую с производств Америки, Европы и Азии, а так же с крупнейших складов мира;
- Широкая линейка поставок активных и пассивных импортных электронных компонентов (более 30 млн. наименований);
- Поставка сложных, дефицитных, либо снятых с производства позиций;
- Оперативные сроки поставки под заказ (от 5 рабочих дней);
- Экспресс доставка в любую точку России;
- Помощь Конструкторского Отдела и консультации квалифицированных инженеров;
- Техническая поддержка проекта, помощь в подборе аналогов, поставка прототипов;
- Поставка электронных компонентов под контролем ВП;
- Система менеджмента качества сертифицирована по Международному стандарту ISO 9001;
- При необходимости вся продукция военного и аэрокосмического назначения проходит испытания и сертификацию в лаборатории (по согласованию с заказчиком);
- Поставка специализированных компонентов военного и аэрокосмического уровня качества (Xilinx, Altera, Analog Devices, Intersil, Interpoint, Microsemi, Actel, Aeroflex, Peregrine, VPT, Syfer, Eurofarad, Texas Instruments, MS Kennedy, Miteq, Cobham, E2V, MA-COM, Hittite, Mini-Circuits, General Dynamics и др.);

Компания «Океан Электроники» является официальным дистрибьютором и эксклюзивным представителем в России одного из крупнейших производителей разъемов военного и аэрокосмического назначения «JONHON», а так же официальным дистрибьютором и эксклюзивным представителем в России производителя высокотехнологичных и надежных решений для передачи СВЧ сигналов «FORSTAR».



JONHON

«JONHON» (основан в 1970 г.)

Разъемы специального, военного и аэрокосмического назначения:

(Применяются в военной, авиационной, аэрокосмической, морской, железнодорожной, горно- и нефтедобывающей отраслях промышленности)

«FORSTAR» (основан в 1998 г.)

ВЧ соединители, коаксиальные кабели,
кабельные сборки и микроволновые компоненты:

(Применяются в телекоммуникациях гражданского и специального назначения, в средствах связи, РЛС, а так же военной, авиационной и аэрокосмической отраслях промышленности).



Телефон: 8 (812) 309-75-97 (многоканальный)

Факс: 8 (812) 320-03-32

Электронная почта: ocean@oceanchips.ru

Web: <http://oceanchips.ru/>

Адрес: 198099, г. Санкт-Петербург, ул. Калинина, д. 2, корп. 4, лит. А