

ZXMN10A07F

100V N-CHANNEL ENHANCEMENT MODE MOSFET IN SOT23 PACKAGE

Product Summary

BV _{DSS}	R _{DS(ON)} Max	I _D T _A = +25°C (Note 6)
100V	700mΩ @ V _{GS} = 10V	0.76A
	900mΩ @ V _{GS} = 6V	0.67A

Description

This MOSFET has been designed to minimize the on-state resistance (R_{DS(on)}) and yet maintain superior switching performance, making it ideal for high efficiency power management applications.

Applications

- DC-DC Converters
- Power Management Functions
- Motor Control
- Disconnect switches

Features

- Low On-Resistance
- Low Threshold
- Fast Switching Speed
- Low Gate Drive
- **Totally Lead-Free & Fully RoHS Compliant (Notes 1 & 2)**
- **Halogen and Antimony Free. "Green" Device (Note 3)**
- **Qualified to AEC-Q101 Standards for High Reliability**

Mechanical Data

- Case: SOT23
- Case Material: Molded Plastic, "Green" Molding Compound. UL Flammability Classification Rating 94V-0
- Moisture Sensitivity: Level 1 per J-STD-020
- Terminals: Matte Tin Finish
- Weight: 0.008 grams (approximate)



Top View

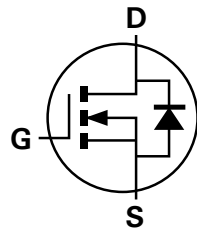

Device Symbol

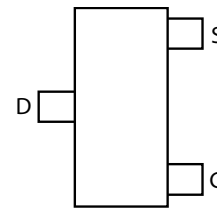

Top View Pin-Out

Ordering Information (Note 4)

Part Number	Marking	Reel size (inches)	Tape width (mm)	Quantity per reel
ZXMN10A07FTA	7N1	7	8	3,000

- Notes:
1. No purposely added lead. Fully EU Directive 2002/95/EC (RoHS) & 2011/65/EU (RoHS 2) compliant.
 2. See <http://www.diodes.com> for more information about Diodes Incorporated's definitions of Halogen and Antimony free, "Green" and Lead-Free.
 3. Halogen and Antimony free "Green" products are defined as those which contain <900ppm bromine, <900ppm chlorine (<1500ppm total Br + Cl) and <1000ppm antimony compounds.
 4. For packaging details, go to our website at <http://www.diodes.com>

Marking Information

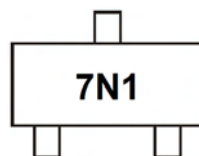

7N1 = Product Type Marking Code

ZXMN10A07F

Maximum Ratings (@T_A = +25°C, unless otherwise specified.)

Characteristic		Symbol	Value	Unit
Drain-Source Voltage		V _{DSS}	100	V
Gate-Source Voltage		V _{GSS}	±20	V
Continuous Drain Current	Steady State	@ V _{GS} = 10V; T _A = +25°C (Note 6)	0.8	A
		@ V _{GS} = 10V; T _A = +70°C (Note 6)	0.6	
		@ V _{GS} = 10V; T _A = +100°C (Note 6)	0.5	
		@ V _{GS} = 10V; T _A = +25°C (Note 5)	0.7	
Pulsed Drain Current (Note 7)		I _{DM}	3.5	A
Continuous Source Current (Body Diode) (Note 6)		I _S	0.5	A
Pulsed Source Current (Body Diode) (Note 7)		I _{SM}	3.5	A

Thermal Characteristics (@T_A = +25°C, unless otherwise specified.)

Characteristic	Symbol	Value	Unit
Power Dissipation (Note 5)	P _D	625	mW
Power Dissipation (Note 6)	P _D	806	mW
Thermal Resistance, Junction to Ambient (Note 5)	R _{θJA}	200	°C/W
Thermal Resistance, Junction to Ambient (Note 6)	R _{θJA}	155	°C/W
Thermal Resistance, Junction to Leads (Note 8)	R _{θJL}	194	°C/W
Operating and Storage Temperature Range	T _J , T _{STG}	-55 to +150	°C

- Notes:
5. For a device surface mounted on 25mm x 25mm FR4 PCB with high coverage of single sided 1oz copper, in still air conditions.
 6. For a device surface mounted on FR4 PCB measured at t ≤ 10 sec.
 7. Repetitive rating - 25mm x 25mm FR4 PCB, D = 0.02, pulse width 300µs – pulse width limited by maximum junction temperature.
 8. Thermal resistance from junction to solder-point (at the end of the drain lead).

Thermal Characteristics

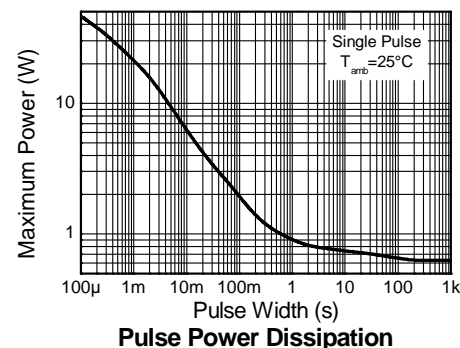
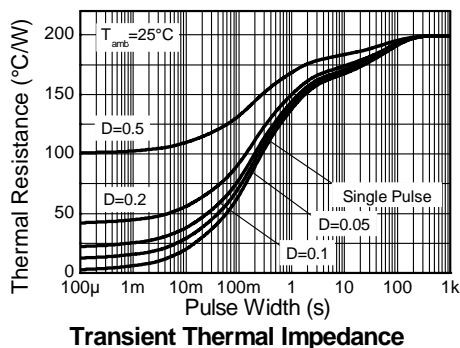
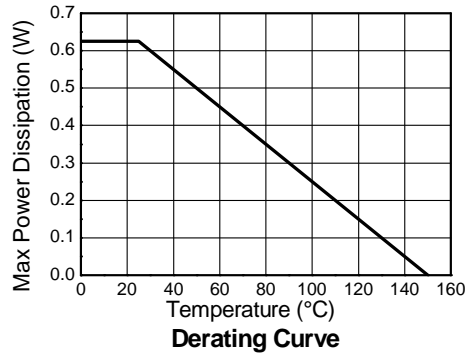
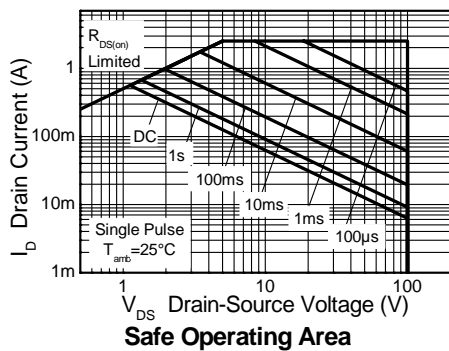

Electrical Characteristics (@T_A = +25°C, unless otherwise specified.)

Characteristic	Symbol	Min	Typ	Max	Unit	Test Condition
OFF CHARACTERISTICS						
Drain-Source Breakdown Voltage	BV _{DSS}	100	—	—	V	V _{GS} = 0V, I _D = 250μA
Zero Gate Voltage Drain Current T _J = +25°C	I _{DSS}	—	—	1.0	μA	V _{DS} = 100V, V _{GS} = 0V
Gate-Source Leakage	I _{GSS}	—	—	100	nA	V _{GS} = ±20V, V _{DS} = 0V
ON CHARACTERISTICS						
Gate Threshold Voltage	V _{GS(th)}	2	—	4	V	V _{DS} = V _{GS} , I _D = 250μA
Static Drain-Source On-Resistance (Note 9)	R _{DS(on)}	—	540	700	mΩ	V _{GS} = 10V, I _D = 1.5A
			700	900		V _{GS} = 6V, I _D = 1A
Forward Transconductance (Notes 9 & 11)	g _{fs}	—	1.6	—	S	V _{DS} = 15V, I _D = 1A
Diodes Forward Voltage (Note 9)	V _{SD}	—	0.85	0.95	V	T _J = +25°C, I _S = 1.5A, V _{GS} = 0V
DYNAMIC CHARACTERISTICS						
Input Capacitance (Notes 10 & 11)	C _{iss}	—	138	280	pF	V _{DS} = 50V, V _{GS} = 0V, f = 1.0MHz
Output Capacitance (Notes 10 & 11)	C _{oss}	—	12	25		
Reverse Transfer Capacitance (Notes 10 & 11)	C _{rss}	—	6	12		
Gate Resistance (Notes 10 & 11)	R _g	—	2	4	Ω	f = 1MHz, V _{GS} = 0V, V _{DS} = 0V
Total Gate Charge (Notes 10 & 11)	Q _g	—	2.9	6	nC	V _{GS} = 10V, V _{DS} = 50V, I _D = 1A
Gate-Source Charge (Notes 10 & 11)	Q _{gs}	—	0.7	1.5		
Gate-Drain Charge (Notes 10 & 11)	Q _{gd}	—	1	2		
Reverse Recovery Time (Note 11)	t _{rr}	—	27	60	ns	T _J = +25°C, I _F = 1.8A, di/dt = 100A/μs
Reverse Recovery Charge (Note 11)	Q _{rr}	—	12	—	nC	
Turn-On Delay Time (Notes 10 & 11)	t _{D(on)}	—	1.8	—	ns	V _{GS} = 10V, V _{DD} = 50V, R _G = 6Ω, I _D = 1A
Turn-On Rise Time (Notes 10 & 11)	t _r	—	1.5	—		
Turn-Off Delay Time (Notes 10 & 11)	t _{D(off)}	—	4.1	—		
Turn-Off Fall Time (Notes 10 & 11)	t _f	—	2.1	—		

Notes:
 9. Measured under pulsed conditions. Pulse width ≤ 300μs; duty cycle ≤ 2%.
 10. Switching characteristics are independent of operating junction temperature.
 11. For design aid only, not subject to production testing.

Typical Characteristics

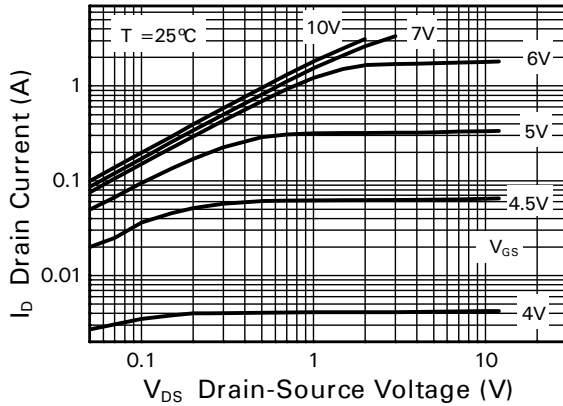

Output Characteristics

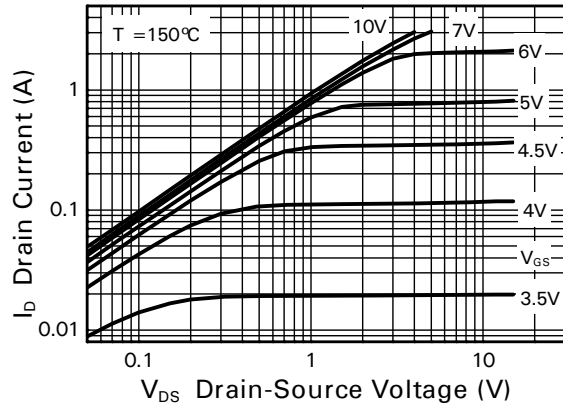

Output Characteristics

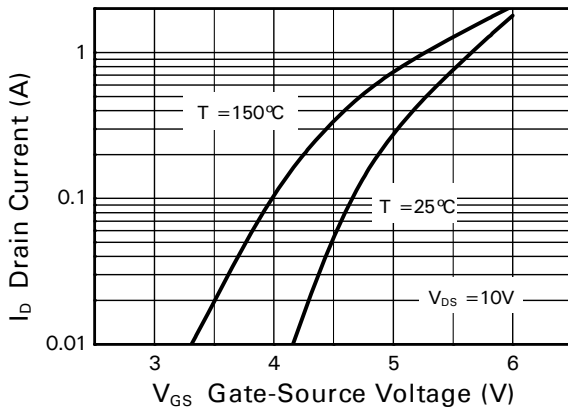

Typical Transfer Characteristics

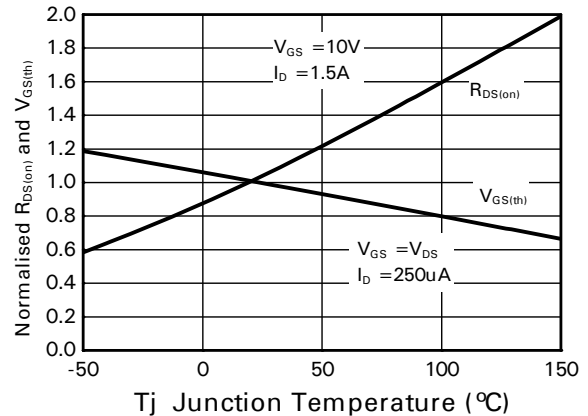

Normalised Curves v Temperature

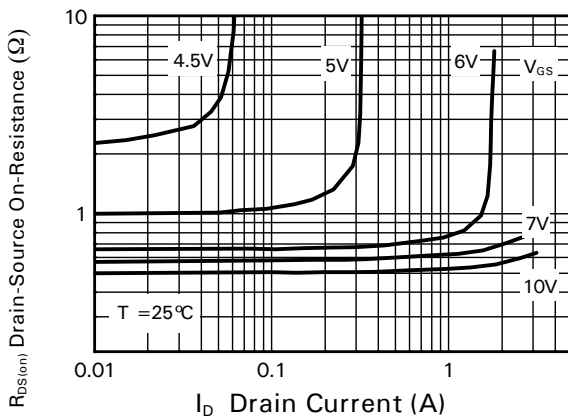

On-Resistance v Drain Current

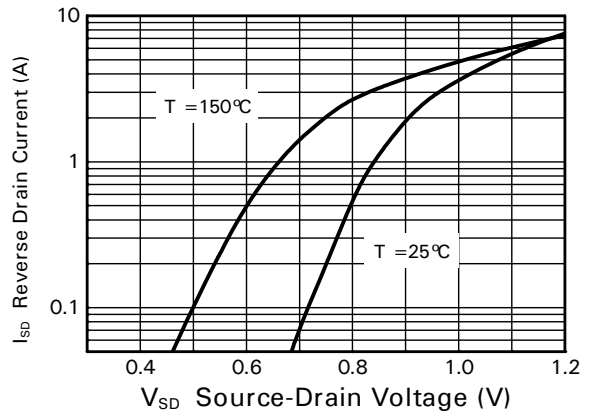

Source-Drain Diode Forward Voltage

Typical Characteristics (cont.)

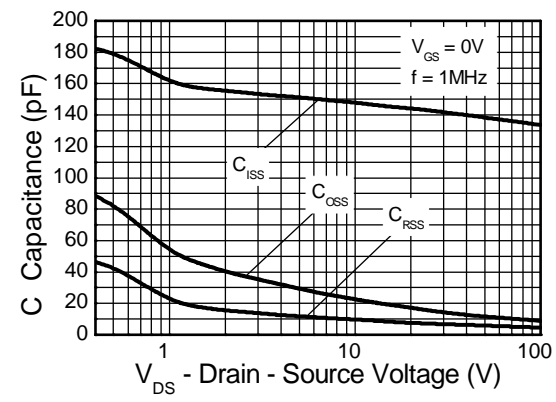

Capacitance v Drain-Source Voltage

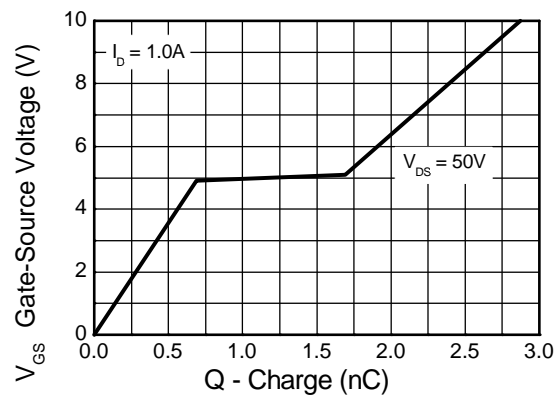

Gate-Source Voltage v Gate Charge

Test Circuits

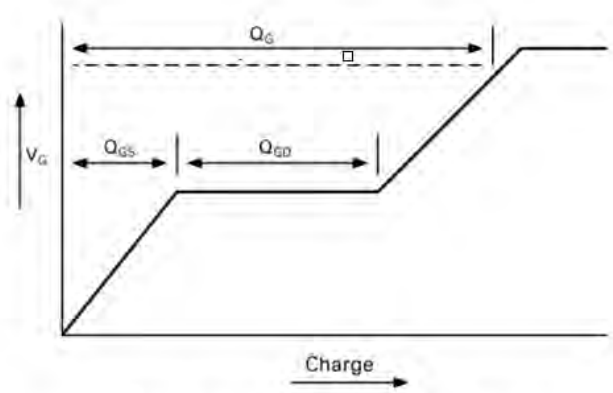

Basic gate charge waveform

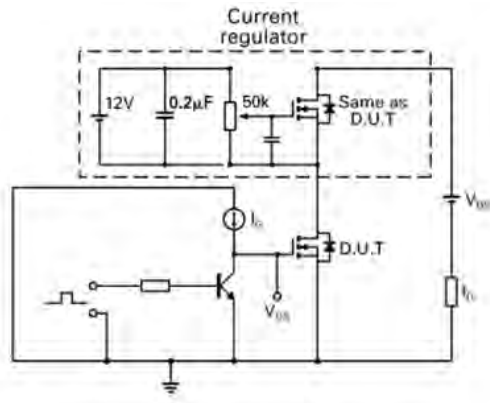

Gate charge test circuit

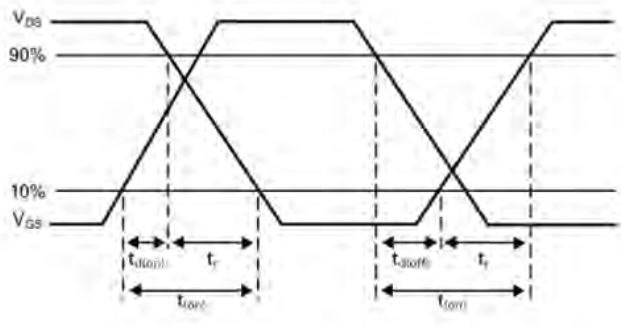

Switching time waveforms

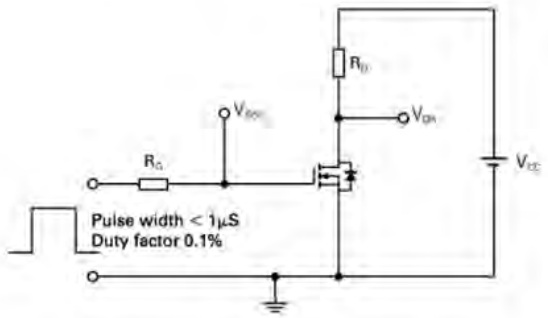

Switching time test circuit

ZXMN10A07F

Package Outline Dimensions

Please see AP02002 at <http://www.diodes.com/datasheets/ap02002.pdf> for latest version.

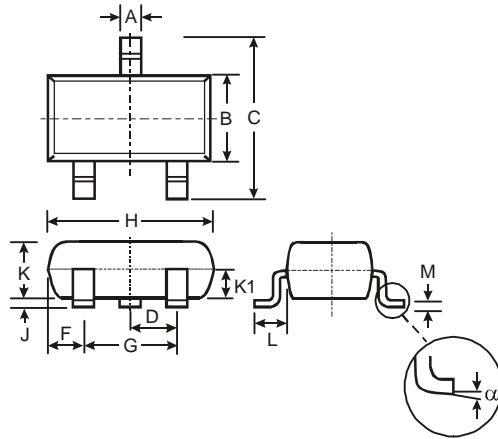

SOT23			
Dim	Min	Max	Typ
A	0.37	0.51	0.40
B	1.20	1.40	1.30
C	2.30	2.50	2.40
D	0.89	1.03	0.915
F	0.45	0.60	0.535
G	1.78	2.05	1.83
H	2.80	3.00	2.90
J	0.013	0.10	0.05
K	0.903	1.10	1.00
K1	-	-	0.400
L	0.45	0.61	0.55
M	0.085	0.18	0.11
α	0°	8°	-
All Dimensions in mm			

Suggested Pad Layout

Please see AP02001 at <http://www.diodes.com/datasheets/ap02001.pdf> for the latest version.

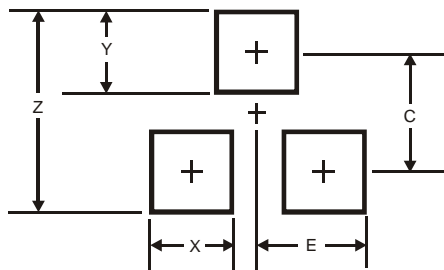

Dimensions	Value (in mm)
Z	2.9
X	0.8
Y	0.9
C	2.0
E	1.35

IMPORTANT NOTICE

DIODES INCORPORATED MAKES NO WARRANTY OF ANY KIND, EXPRESS OR IMPLIED, WITH REGARDS TO THIS DOCUMENT, INCLUDING, BUT NOT LIMITED TO, THE IMPLIED WARRANTIES OF MERCHANTABILITY AND FITNESS FOR A PARTICULAR PURPOSE (AND THEIR EQUIVALENTS UNDER THE LAWS OF ANY JURISDICTION).

Diodes Incorporated and its subsidiaries reserve the right to make modifications, enhancements, improvements, corrections or other changes without further notice to this document and any product described herein. Diodes Incorporated does not assume any liability arising out of the application or use of this document or any product described herein; neither does Diodes Incorporated convey any license under its patent or trademark rights, nor the rights of others. Any Customer or user of this document or products described herein in such applications shall assume all risks of such use and will agree to hold Diodes Incorporated and all the companies whose products are represented on Diodes Incorporated website, harmless against all damages.

Diodes Incorporated does not warrant or accept any liability whatsoever in respect of any products purchased through unauthorized sales channel. Should Customers purchase or use Diodes Incorporated products for any unintended or unauthorized application, Customers shall indemnify and hold Diodes Incorporated and its representatives harmless against all claims, damages, expenses, and attorney fees arising out of, directly or indirectly, any claim of personal injury or death associated with such unintended or unauthorized application.

Products described herein may be covered by one or more United States, international or foreign patents pending. Product names and markings noted herein may also be covered by one or more United States, international or foreign trademarks.

LIFE SUPPORT

Diodes Incorporated products are specifically not authorized for use as critical components in life support devices or systems without the express written approval of the Chief Executive Officer of Diodes Incorporated. As used herein:

A. Life support devices or systems are devices or systems which:

1. are intended to implant into the body, or
2. support or sustain life and whose failure to perform when properly used in accordance with instructions for use provided in the labeling can be reasonably expected to result in significant injury to the user.

B. A critical component is any component in a life support device or system whose failure to perform can be reasonably expected to cause the failure of the life support device or to affect its safety or effectiveness.

Customers represent that they have all necessary expertise in the safety and regulatory ramifications of their life support devices or systems, and acknowledge and agree that they are solely responsible for all legal, regulatory and safety-related requirements concerning their products and any use of Diodes Incorporated products in such safety-critical, life support devices or systems, notwithstanding any devices- or systems-related information or support that may be provided by Diodes Incorporated. Further, Customers must fully indemnify Diodes Incorporated and its representatives against any damages arising out of the use of Diodes Incorporated products in such safety-critical, life support devices or systems.

Copyright © 2012, Diodes Incorporated

www.diodes.com

Компания «Океан Электроники» предлагает заключение долгосрочных отношений при поставках импортных электронных компонентов на взаимовыгодных условиях!

Наши преимущества:

- Поставка оригинальных импортных электронных компонентов напрямую с производств Америки, Европы и Азии, а так же с крупнейших складов мира;
- Широкая линейка поставок активных и пассивных импортных электронных компонентов (более 30 млн. наименований);
- Поставка сложных, дефицитных, либо снятых с производства позиций;
- Оперативные сроки поставки под заказ (от 5 рабочих дней);
- Экспресс доставка в любую точку России;
- Помощь Конструкторского Отдела и консультации квалифицированных инженеров;
- Техническая поддержка проекта, помощь в подборе аналогов, поставка прототипов;
- Поставка электронных компонентов под контролем ВП;
- Система менеджмента качества сертифицирована по Международному стандарту ISO 9001;
- При необходимости вся продукция военного и аэрокосмического назначения проходит испытания и сертификацию в лаборатории (по согласованию с заказчиком);
- Поставка специализированных компонентов военного и аэрокосмического уровня качества (Xilinx, Altera, Analog Devices, Intersil, Interpoint, Microsemi, Actel, Aeroflex, Peregrine, VPT, Syfer, Eurofarad, Texas Instruments, MS Kennedy, Miteq, Cobham, E2V, MA-COM, Hittite, Mini-Circuits, General Dynamics и др.);

Компания «Океан Электроники» является официальным дистрибьютором и эксклюзивным представителем в России одного из крупнейших производителей разъемов военного и аэрокосмического назначения «JONHON», а так же официальным дистрибьютором и эксклюзивным представителем в России производителя высокотехнологичных и надежных решений для передачи СВЧ сигналов «FORSTAR».



JONHON

«JONHON» (основан в 1970 г.)

Разъемы специального, военного и аэрокосмического назначения:

(Применяются в военной, авиационной, аэрокосмической, морской, железнодорожной, горно- и нефтедобывающей отраслях промышленности)

«FORSTAR» (основан в 1998 г.)

ВЧ соединители, коаксиальные кабели, кабельные сборки и микроволновые компоненты:

(Применяются в телекоммуникациях гражданского и специального назначения, в средствах связи, РЛС, а так же военной, авиационной и аэрокосмической отраслях промышленности).



Телефон: 8 (812) 309-75-97 (многоканальный)

Факс: 8 (812) 320-03-32

Электронная почта: ocean@oceanchips.ru

Web: <http://oceanchips.ru/>

Адрес: 198099, г. Санкт-Петербург, ул. Калинина, д. 2, корп. 4, лит. А