

IRIS-SCREW

~5° real spot beam with holder optimized for CREE XP-E. Assembly with screws.

TECHNICAL SPECIFICATIONS:

Dimensions	Ø 38.0 mm
Height	26.9 mm
Fastening	glue, pin, screw
ROHS compliant	yes ⓘ

MATERIAL SPECIFICATIONS:

Component	Type	Material	Colour	Finish
IRIS	Single lens	PMMA	clear	
IRIS-XP-HLD	Holder	PC	black	

ORDERING INFORMATION:

Component		Qty in box	MOQ	MPQ	Box weight (kg)
FCN12076_IRIS-SCREW	Single lens	360		90	0.0
» Box size:					



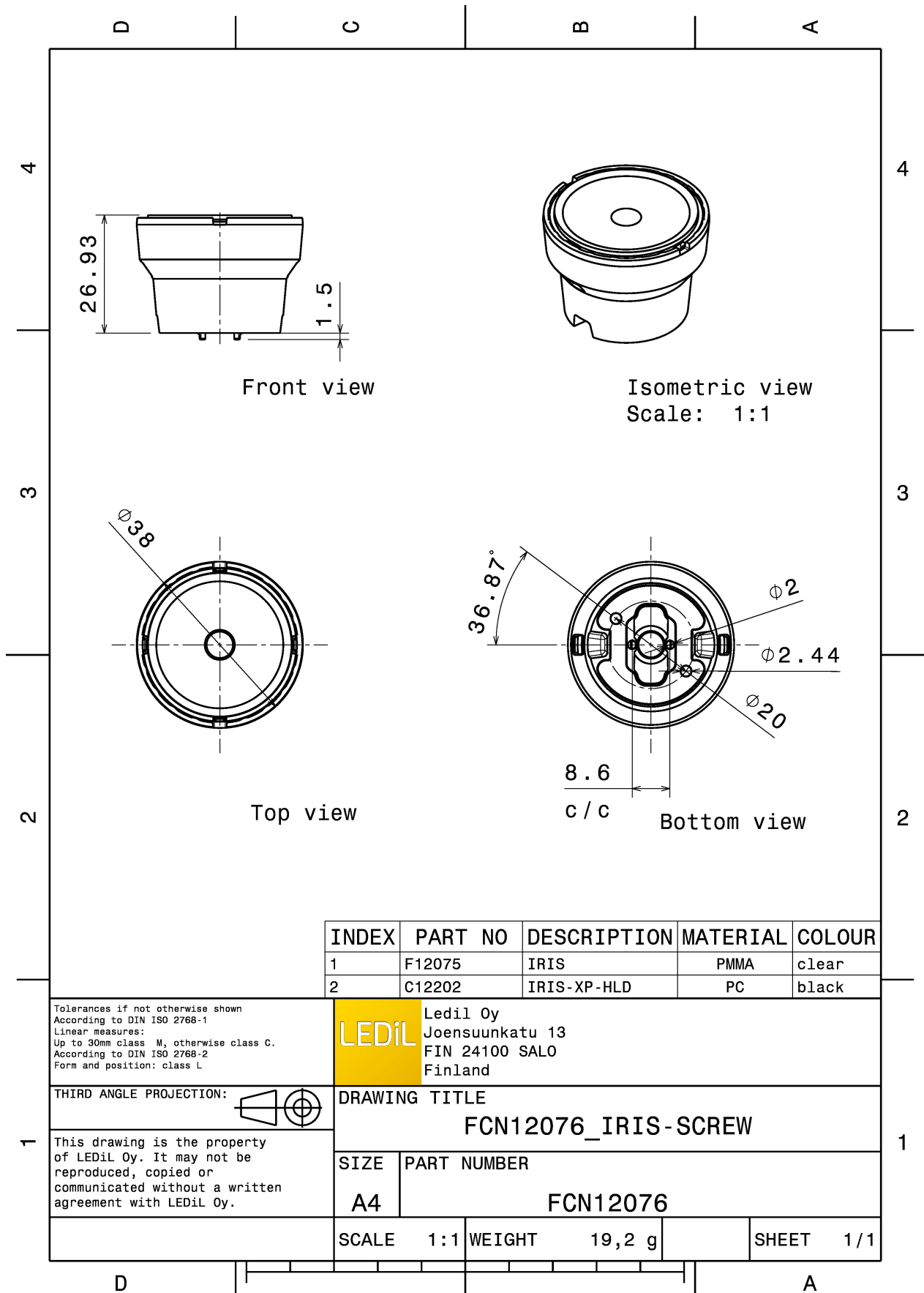

INDEX	PART NO	DESCRIPTION	MATERIAL	COLOUR
1	F12075	IRIS	PMMA	clear
2	C12202	IRIS-XP-HLD	PC	black

Tolerances if not otherwise shown
According to DIN ISO 2768-1
Linear measures:
Up to 30mm class M, otherwise class C.
According to DIN ISO 2768-2
Form and position: class L

LEDiL Ledil Oy
Joensuunkatu 13
FIN 24100 SALO
Finland

THIRD ANGLE PROJECTION:

DRAWING TITLE
FCN12076_IRIS-SCREW

This drawing is the property of LEDiL Oy. It may not be reproduced, copied or communicated without a written agreement with LEDiL Oy.

SIZE	PART NUMBER
A4	FCN12076

SCALE	1:1	WEIGHT	19,2 g	SHEET	1/1
-------	-----	--------	--------	-------	-----

PHOTOMETRIC DATA (MEASURED):

CREE

LED XHP35 HI
 FWHM 7.6°
 Efficiency 90 %
 Peak intensity 35.9 cd/lm
 LEDs/each optic 1
 Light colour White
 Required components:

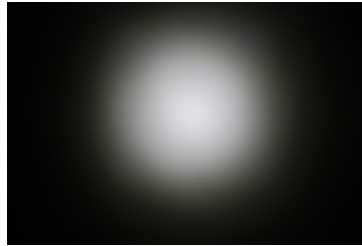

CREE

LED XP-E
 FWHM 4.0°
 Efficiency 93 %
 Peak intensity 87.4 cd/lm
 LEDs/each optic 1
 Light colour White
 Required components:

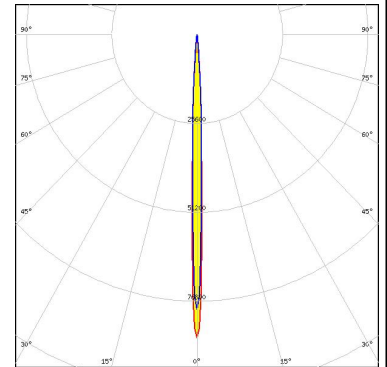

CREE

LED XP-G
 FWHM 5.0°
 Efficiency 93 %
 Peak intensity 52 cd/lm
 LEDs/each optic 1
 Light colour White
 Required components:

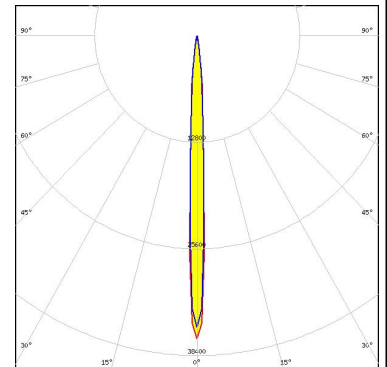
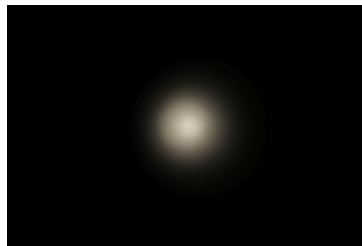

CREE

LED XP-L HD
 FWHM 8.5°
 Efficiency 93 %
 Peak intensity 22.2 cd/lm
 LEDs/each optic 1
 Light colour White
 Required components:

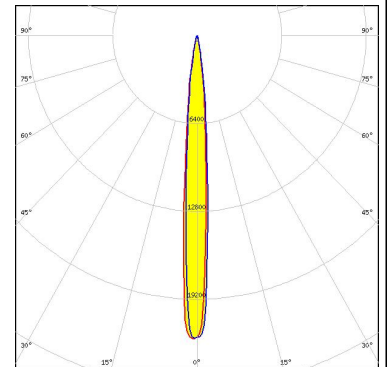

PHOTOMETRIC DATA (MEASURED):

LUMILEDS

LED LUXEON Rebel
 FWHM 5.0°
 Efficiency 93 %
 Peak intensity 75.6 cd/Im
 LEDs/each optic 1
 Light colour White
 Required components:

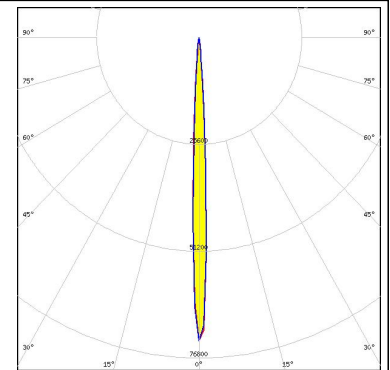

LUMILEDS

LED LUXEON Rebel ES
 FWHM 7.0°
 Efficiency 93 %
 Peak intensity 38.5 cd/Im
 LEDs/each optic 1
 Light colour White
 Required components:

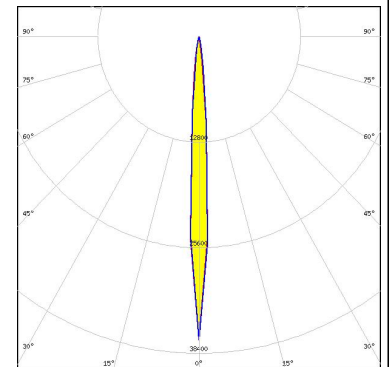
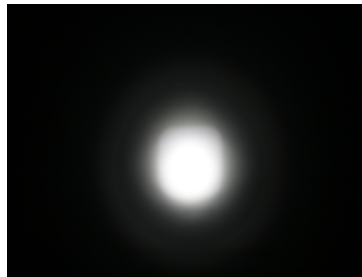

LUMILEDS

LED LUXEON V
 FWHM 9.0°
 Efficiency 92 %
 Peak intensity 20.6 cd/Im
 LEDs/each optic 1
 Light colour White
 Required components:

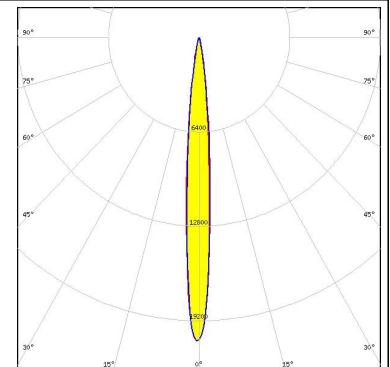
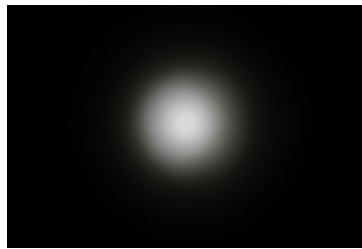

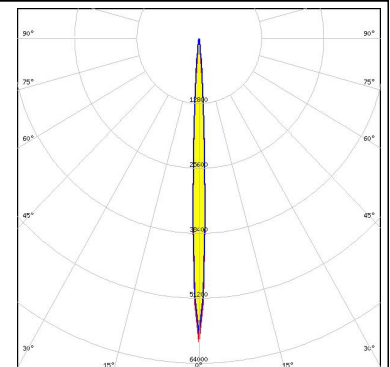

NICHIA

LED NCSxx19A
 FWHM 5.0°
 Efficiency %
 LEDs/each optic 1
 Light colour White
 Required components:

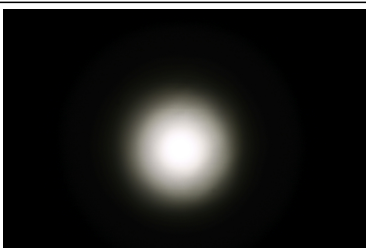
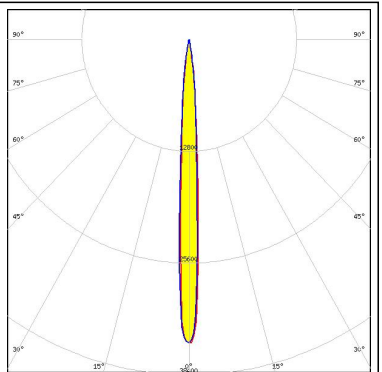
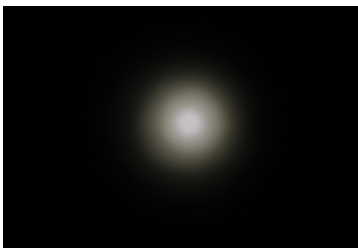
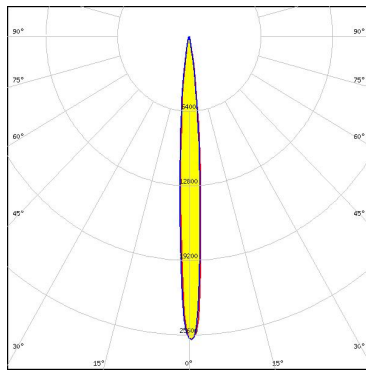

PHOTOMETRIC DATA (MEASURED):

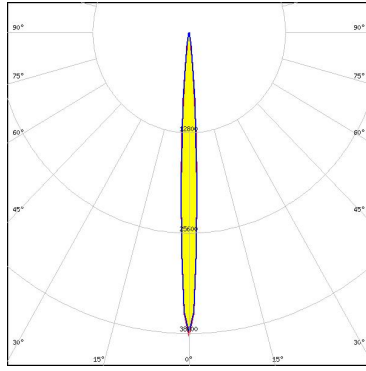
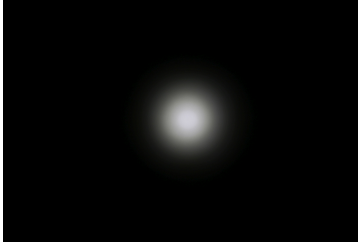
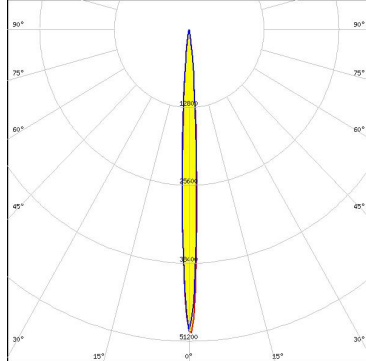
<p>NICHIA</p> <p>LED NVSW219F FWHM 7.0° Efficiency 93 % Peak intensity 34.8 cd/lm LEDs/each optic 1 Light colour White Required components:</p>		
<p>NICHIA</p> <p>LED NVSW3x9A FWHM 8.0° Efficiency 90 % Peak intensity 26.1 cd/lm LEDs/each optic 1 Light colour White Required components:</p>		
<p>NICHIA</p> <p>LED NVSxx19A FWHM 6.0° Efficiency 93 % Peak intensity 38.7 cd/lm LEDs/each optic 1 Light colour White Required components:</p>		
<p>OSRAM <small>Opto Semiconductors</small></p> <p>LED OSLOM Square CSSRM2/CSSRM3 FWHM 6.0° Efficiency 94 % Peak intensity 49.9 cd/lm LEDs/each optic 1 Light colour White Required components:</p>		

PHOTOMETRIC DATA (MEASURED):

OSRAM
Opto Semiconductors

LED OSLON SSL 150
FWHM 4.0°
Efficiency 93 %
Peak intensity 76.8 cd/lm
LEDs/each optic 1
Light colour White
Required components:

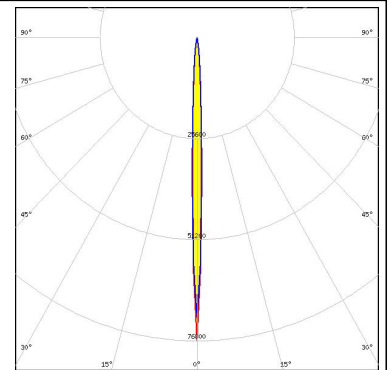

OSRAM
Opto Semiconductors

LED OSLON SSL 80
FWHM 4.0°
Efficiency 90 %
Peak intensity 89 cd/lm
LEDs/each optic 1
Light colour White
Required components:

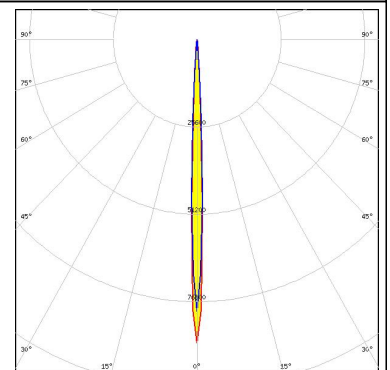

SEOL

SEOUL SEMICONDUCTOR

LED Z5M3
FWHM 7.0°
Efficiency 92 %
Peak intensity 3.1 cd/lm
LEDs/each optic 1
Light colour White
Required components:

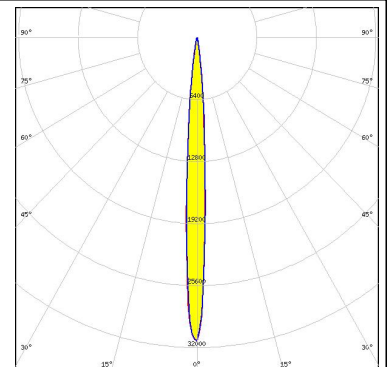

PHOTOMETRIC DATA (SIMULATED):



LED XP-E2
 FWHM 5.9°
 Efficiency 94 %
 Peak intensity 56.6 cd/lm
 LEDs/each optic 1
 Light colour White
 Required components:

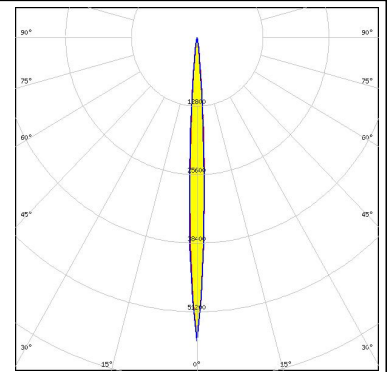

LED XP-G2
 FWHM 6.7°
 Efficiency 94 %
 Peak intensity 44.3 cd/lm
 LEDs/each optic 1
 Light colour White
 Required components:

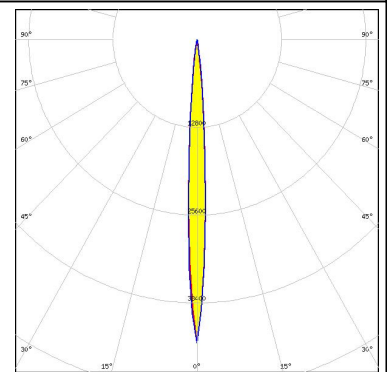

LED XP-G2 HE
 FWHM 8.0°
 Efficiency 90 %
 Peak intensity 28.6 cd/lm
 LEDs/each optic 1
 Light colour White
 Required components:

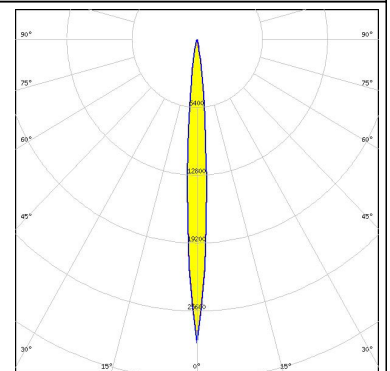

LED XP-G3
 FWHM 7.5°
 Efficiency 91 %
 Peak intensity 29.6 cd/lm
 LEDs/each optic 1
 Light colour White
 Required components:

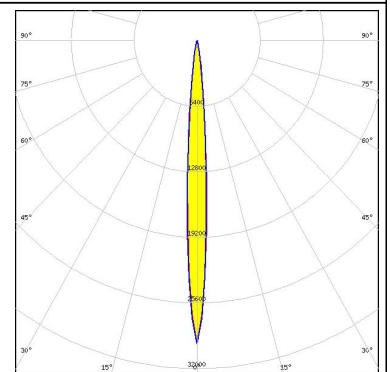

PHOTOMETRIC DATA (SIMULATED):



LED XQ-E HD
 FWHM 5.0°
 Efficiency 93 %
 Peak intensity 80 cd/lm
 LEDs/each optic 1
 Light colour White
 Required components:



LED XQ-E HD
 FWHM 5.5°
 Efficiency 94 %
 Peak intensity 74.2 cd/lm
 LEDs/each optic 1
 Light colour White
 Required components:

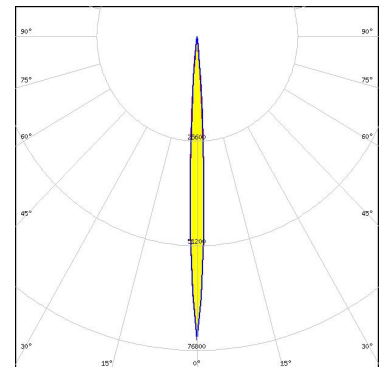

LED OSCONIQ P 3737 (2W version)
 FWHM 6.5°
 Efficiency 94 %
 Peak intensity 46.4 cd/lm
 LEDs/each optic 1
 Light colour White
 Required components:

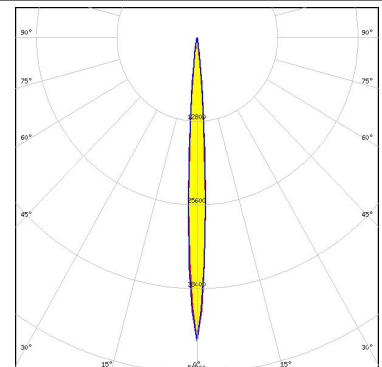

LED OSCONIQ P 3737 (3W version)
 FWHM 9.0°
 Efficiency 94 %
 Peak intensity 25.5 cd/lm
 LEDs/each optic 1
 Light colour White
 Required components:

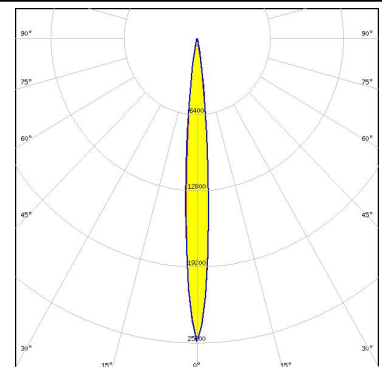

PHOTOMETRIC DATA (SIMULATED):

SAMSUNG

LED LH351B
 FWHM 7.4°
 Efficiency 94 %
 Peak intensity 33.9 cd/lm
 LEDs/each optic 1
 Light colour White
 Required components:

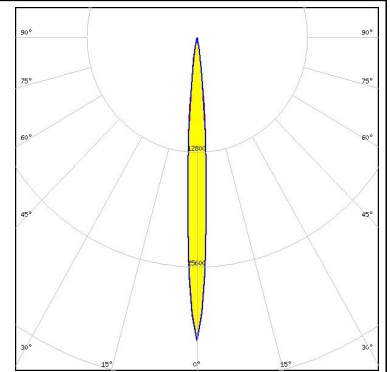

SAMSUNG

LED LH351D
 FWHM 9.2°
 Efficiency 90 %
 Peak intensity 20.6 cd/lm
 LEDs/each optic 1
 Light colour White
 Required components:

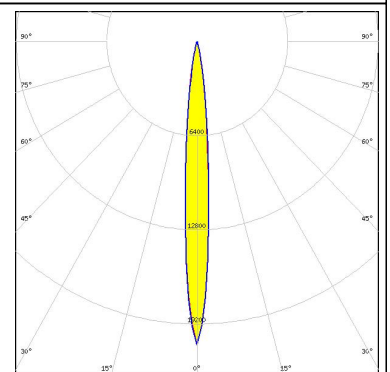

SAMSUNG

LED LM101B
 FWHM 6.0°
 Efficiency 92 %
 Peak intensity 58.9 cd/lm
 LEDs/each optic 1
 Light colour White
 Required components:

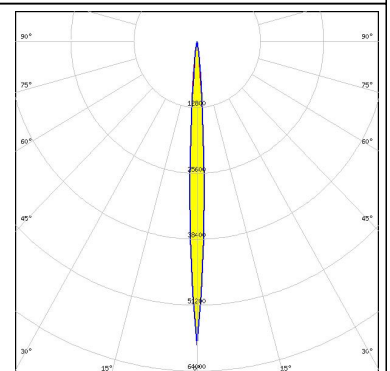

SEOUL SEMICONDUCTOR

LED Z8Y22P
 FWHM 8.0°
 Efficiency 98 %
 Peak intensity 29.9 cd/lm
 LEDs/each optic 1
 Light colour White
 Required components:

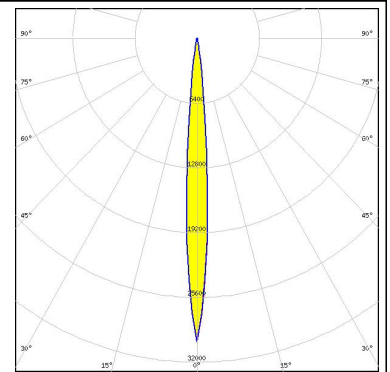

GENERAL INFORMATION:

NOTE: The typical beam angle will be changed by different color, chip size and chip position tolerance. The typical total beam angle is the full angle measured where the luminous intensity is half of the peak value.

MATERIALS:

As part of our continuous research and improvement processes, and to ensure the best possible quality and availability of our products, LEDiL reserves the right to change material grades without notice.

PRODUCT DATA USER AGREEMENT AND DISCLAIMER:

The measured data in the provided downloadable LEDiL Product Datasheets and Mechanical 2D-Drawings is rounded and provided as reference for planning. LEDiL Oy's optical specifications have been verified by conducting performance testing of the products in accordance with the company's quality system. The reported data are averaged results of multiple measurements with typical variation. LEDiL Oy reserves the right to without prior notification make changes and improvements to its products.

LEDiL Oy assumes neither warranty, nor guarantee nor any other liability of any kind for the contents and correctness of the provided data. The provided data has been generated with highest diligence but the provided data may in reality not represent the complete possible variation range of all intrinsic parameters. Therefore, in certain cases a deviation from the provided data could occur.

LEDiL Oy reserves the right to undertake technical changes of its products without further notification which could lead to changes in the provided data. LEDiL Oy assumes no liability of any kind for the possible deviation from any provided data or any other damage resulting from the usage of the provided data.

The user agrees to this disclaimer and user agreement with the download or usage of the provided files.

LEDiL Oy

Joensuunkatu 13
FI-24240 SALO
Finland

LEDiL Inc.

228 West Page Street
Suite D
Sycamore IL 60178
USA

Local sales and technical support

[www.ledil.com/
where_to_buy](http://www.ledil.com/where_to_buy)

Shipping locations

Salo, Finland
Hong Kong, China

Distribution Partners

[www.ledil.com/
where_to_buy](http://www.ledil.com/where_to_buy)

Компания «Океан Электроники» предлагает заключение долгосрочных отношений при поставках импортных электронных компонентов на взаимовыгодных условиях!

Наши преимущества:

- Поставка оригинальных импортных электронных компонентов напрямую с производств Америки, Европы и Азии, а так же с крупнейших складов мира;
- Широкая линейка поставок активных и пассивных импортных электронных компонентов (более 30 млн. наименований);
- Поставка сложных, дефицитных, либо снятых с производства позиций;
- Оперативные сроки поставки под заказ (от 5 рабочих дней);
- Экспресс доставка в любую точку России;
- Помощь Конструкторского Отдела и консультации квалифицированных инженеров;
- Техническая поддержка проекта, помощь в подборе аналогов, поставка прототипов;
- Поставка электронных компонентов под контролем ВП;
- Система менеджмента качества сертифицирована по Международному стандарту ISO 9001;
- При необходимости вся продукция военного и аэрокосмического назначения проходит испытания и сертификацию в лаборатории (по согласованию с заказчиком);
- Поставка специализированных компонентов военного и аэрокосмического уровня качества (Xilinx, Altera, Analog Devices, Intersil, Interpoint, Microsemi, Actel, Aeroflex, Peregrine, VPT, Syfer, Eurofarad, Texas Instruments, MS Kennedy, Miteq, Cobham, E2V, MA-COM, Hittite, Mini-Circuits, General Dynamics и др.);

Компания «Океан Электроники» является официальным дистрибьютором и эксклюзивным представителем в России одного из крупнейших производителей разъемов военного и аэрокосмического назначения «JONHON», а так же официальным дистрибьютором и эксклюзивным представителем в России производителя высокотехнологичных и надежных решений для передачи СВЧ сигналов «FORSTAR».



JONHON

«JONHON» (основан в 1970 г.)

Разъемы специального, военного и аэрокосмического назначения:

(Применяются в военной, авиационной, аэрокосмической, морской, железнодорожной, горно- и нефтедобывающей отраслях промышленности)

«FORSTAR» (основан в 1998 г.)

ВЧ соединители, коаксиальные кабели, кабельные сборки и микроволновые компоненты:

(Применяются в телекоммуникациях гражданского и специального назначения, в средствах связи, РЛС, а так же военной, авиационной и аэрокосмической отраслях промышленности).



Телефон: 8 (812) 309-75-97 (многоканальный)

Факс: 8 (812) 320-03-32

Электронная почта: ocean@oceanchips.ru

Web: <http://oceanchips.ru/>

Адрес: 198099, г. Санкт-Петербург, ул. Калинина, д. 2, корп. 4, лит. А