

Features

- 32.768 kHz ± 5 , ± 10 , ± 20 ppm frequency stability options over temp
- World's smallest TCXO in a 1.5 x 0.8 mm CSP
- Operating temperature ranges:
 - 0°C to +70°C
 - 40°C to +85°C
- Ultra-low power: <1 μ A
- Vdd supply range: 1.5V to 3.63V
- Improved stability reduces system power with fewer network timekeeping updates
- Internal filtering eliminates external Vdd bypass cap and saves space
- Pb-free, RoHS and REACH compliant

Applications

- Smart Meters (AMR)
- Health and Wellness Monitors
- Pulse-per-Second (pps) Timekeeping
- RTC Reference Clock



Electrical Specifications

Table 1. Electrical Characteristics

Parameter	Symbol	Min.	Typ.	Max.	Unit	Condition
Frequency and Stability						
Output Frequency	F _{out}	32.768			kHz	
Frequency Stability Over Temperature^[1] (without Initial Offset^[2])	F _{stab}	-5.0		5.0	ppm	Stability part number code = E
		-10		10		Stability part number code = F
		-20		20		Stability part number code = 1
Frequency Stability Over Temperature (with Initial Offset^[2])	F _{stab}	-10		10	ppm	Stability part number code = E
		-13		13		Stability part number code = F
		-22		22		Stability part number code = 1
Frequency Stability vs Voltage	F _{vdd}	-0.75		0.75	ppm	1.8V \pm 10%
		-1.5		1.5	ppm	1.5V – 3.63V
First Year Frequency Aging	F _{aging}	-1.0		1.0	ppm	T _A = 25°C, Vdd = 3.3V
Jitter Performance (T_A = over temp)						
Long Term Jitter				2.5	μ s _{pp}	81920 cycles (2.5 sec), 100 samples
Period Jitter			35		nSRMS	Cycles = 10,000, T _A = 25°C, Vdd = 1.5V – 3.63V
Supply Voltage and Current Consumption						
Operating Supply Voltage	Vdd	1.5		3.63	V	T _A = -40°C to +85°C
Core Supply Current^[3]	I _{dd}		0.99		μ A	T _A = 25°C, Vdd = 1.8V, LVCMOS Output configuration, No Load
				1.52		T _A = -40°C to +85°C, Vdd = 1.5V – 3.63V, No Load
Power-Supply Ramp	t _{Vdd_Ramp}			100	ms	Vdd Ramp-Up 0 to 90% Vdd, T _A = -40°C to +85°C
Start-up Time at Power-up	t _{start}		180	300	ms	T _A = -40°C +60°C, valid output
				350		T _A = +60°C to +70°C, valid output
				380		T _A = +70°C to +85°C, valid output

Notes:

- No board level underfill. Measured as peak-to-peak/2. Inclusive of 3x-reflow and $\pm 20\%$ load variation. Tested with Agilent 53132A frequency counter. Due to the low operating frequency, the gate time must be ≥ 100 ms to ensure an accurate frequency measurement.
- Initial offset is defined as the frequency deviation from the ideal 32.768 kHz at room temperature, post reflow.
- Core operating current does not include output driver operating current or load current. To derive total operating current (no load), add core operating current + output driver operating current, which is a function of the output voltage swing. See the description titled [Calculating Load Current](#).

Table 1. Electrical Characteristics (continued)

Parameter	Symbol	Min.	Typ.	Max.	Unit	Condition
Operating Temperature Range						
Commercial Temperature	Op_Temp	0		70	°C	
Industrial Temperature		-40		85	°C	
LVC MOS Output						
Output Rise/Fall Time	tr, tf		100	200	ns	10-90% (Vdd), 15 pF Load
				50		10-90% (Vdd), 5 pF Load, Vdd ≥ 1.62V
Output Clock Duty Cycle	DC	48		52	%	
Output Voltage High	VOH	90%			V	Vdd: 1.5V – 3.63V. IOH = -1 µA, 15 pF Load
Output Voltage Low	VOL			10%	V	Vdd: 1.5V – 3.63V. IOL = 1 µA, 15 pF Load
NanoDrive™ Programmable, Reduced Swing Output						
Output Rise/Fall Time	tf, tf			200	ns	30-70% (VOL/VOH), 10 pF Load
Output Clock Duty Cycle	DC	48		52	%	
AC-coupled Programmable Output Swing	V_sw		0.20 to 0.80		V	SiT1552 does not internally AC-couple. This output description is intended for a receiver that is AC-coupled. See Table 4 for acceptable NanoDrive swing options. Vdd: 1.5V – 3.63V, 10 pF Load, IOH/ IOL = ±0.2 µA.
DC-Biased Programmable Output Voltage High Range	VOH		0.60 to 1.225		V	Vdd: 1.5V – 3.63V. IOH = -0.2 µA, 10 pF Load. See Table 4 for acceptable VOH/VOL setting levels.
DC-Biased Programmable Output Voltage Low Range	VOL		0.35 to 0.80		V	Vdd: 1.5V – 3.63V. IOL = 0.2 µA, 10 pF Load. See Table 4 for acceptable VOH/VOL setting levels.
Programmable Output Voltage Swing Tolerance		-0.055		0.055	V	TA = -40°C to +85°C, Vdd = 1.5V to 3.63V.

Table 2. Pin Configuration

CSP Pin	Symbol	I/O	Functionality
1, 4	GND	Power Supply Ground	Connect to ground. All GND pins must be connected to power supply ground. The GND pins can be connected together, as long as both GND pins are connected ground.
2	CLK Out	OUT	Oscillator clock output. When interfacing to an MCU's XTAL, the CLK Out is typically connected to the receiving IC's X IN pin. The SiT1552 oscillator output includes an internal driver. As a result, the output swing and operation is not dependent on capacitive loading. This makes the output much more flexible, layout independent, and robust under changing environmental and manufacturing conditions.
3	Vdd	Power Supply	Connect to power supply 1.5V ≤ Vdd ≤ 3.63V. Under normal operating conditions, Vdd does not require external bypass/decoupling capacitor(s). For more information about the internal power-supply filtering, see Power-Supply Noise Immunity section in the detailed description. Contact SiTime for applications that require a wider operating supply voltage range.

CSP Package (Top View)

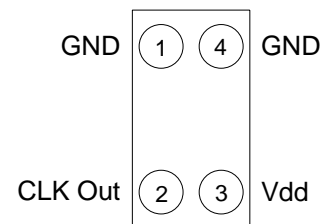

Figure 1. Pin Assignments

System Block Diagram

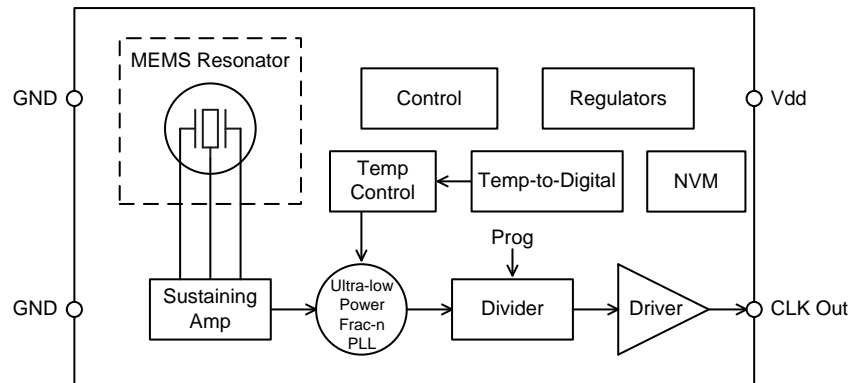

Figure 2. SiT1552 Block Diagram

Table 3. Absolute Maximum Limits

Attempted operation outside the absolute maximum ratings cause permanent damage to the part. Actual performance of the IC is only guaranteed within the operational specifications, not at absolute maximum ratings.

Parameter	Test Condition	Value	Unit
Continuous Power Supply Voltage Range (Vdd)		-0.5 to 3.63	V
Short Duration Maximum Power Supply Voltage (Vdd)	≤30 minutes	4.0	V
Continuous Maximum Operating Temperature Range	Vdd = 1.5V - 3.63V	105	°C
Short Duration Maximum Operating Temperature Range	Vdd = 1.5V - 3.63V, ≤30 mins	125	°C
Human Body Model (HBM) ESD Protection	JESD22-A114	3000	V
Charge-Device Model (CDM) ESD Protection	JESD22- C101	750	V
Machine Model (MM) ESD Protection	JESD22- A115	300	V
Latch-up Tolerance	JESD78 Compliant		
Mechanical Shock Resistance	Mil 883, Method 2002	10,000	<i>g</i>
Mechanical Vibration Resistance	Mil 883, Method 2007	70	<i>g</i>
1508 CSP Junction Temperature		150	°C
Storage Temperature		-65°C to 150°C	

Description

The [SiT1552](#) is an ultra-small and ultra-low power 32.768 kHz TCXO optimized for battery-powered applications. SiTime's silicon MEMS technology enables the first 32 kHz TCXO in the world's smallest footprint and chip-scale packaging (CSP). Typical core supply current is only 1 μ A.

SiTime's MEMS oscillators consist of MEMS resonators and a programmable analog circuit. Our MEMS resonators are built with SiTime's unique MEMS First™ process. A key manufacturing step is EpiSeal™ during which the MEMS resonator is annealed with temperatures over 1000°C. EpiSeal creates an extremely strong, clean, vacuum chamber that encapsulates the MEMS resonator and ensures the best performance and reliability. During EpiSeal, a poly silicon cap is grown on top of the resonator cavity, which eliminates the need for additional cap wafers or other exotic packaging. As a result, SiTime's MEMS resonator die can be used like any other semiconductor die. One unique result of SiTime's MEMS First and EpiSeal manufacturing processes is the capability to integrate SiTime's MEMS die with a SOC, ASIC, microprocessor or analog die within a package to eliminate external timing components and provide a highly integrated, smaller, cheaper solution to the customer.

TCXO Frequency Stability

The SiT1552 is factory calibrated (trimmed) over multiple temperature points to guarantee extremely tight stability over temperature. Unlike quartz crystals that have a classic tuning fork parabola temperature curve with a 25°C turnover point with a 0.04 ppm/C² temperature coefficient, the SiT1552 temperature coefficient is calibrated and corrected over temperature with an active temperature correction circuit. The result is 32 kHz TCXO with extremely tight frequency variation over the -40°C to +85°C temperature range. Contact [SiTime](#) for applications that require a wider supply voltage range >3.63V, or lower operating frequency below 32 kHz.

When measuring the SiT1552 output frequency with a frequency counter, it is important to make sure the counter's gate time is >100 ms. The slow frequency of a 32kHz clock will give false readings with faster gate times.

Power Supply Noise Immunity

In addition to eliminating external output load capacitors common with standard XTALs, this device includes special power supply filtering and thus, eliminates the need for an external V_{dd} bypass-decoupling capacitor to keep the footprint as small as possible. Internal power supply filtering is designed to reject more than \pm 150 mV noise and frequency components from low frequency to more than 10 MHz.

Start-up and Steady-State Supply Current

The SiT1552 TCXO starts-up to a valid output frequency within 300 ms (180 mstyp). To ensure the device starts-up within the specified limit, make sure the power-supply ramps-up in approximately 10 – 20 ms (to within 90% of V_{dd}).

During initial power-up, the SiT1552 power-cycles internal blocks, as shown in the power-supply start-up and steady state plot in the [Typical Operating Curves](#) section. Power-up and initialization is typically 200 ms, and during that time, the peak supply current reaches 28 μ A as the internal capacitors are charged, then sequentially drops to its 990 nA steady-state current. During steady-state operation, the internal temperature compensation circuit turns on every 350 ms for a duration of approximately 10 ms.

Output Voltage

The SiT1552 has two output voltage options. One option is a standard LVCMOS output swing. The second option is the NanoDrive reduced swing output. Output swing is customer specific and programmed between 200 mV and 800 mV. For DC-coupled applications, output V_{OH} and V_{OL} are individually factory programmed to the customers' requirement. V_{OH} programming range is between 600 mV and 1.225V in 100 mV increments. Similarly, V_{OL} programming range is between 350 mV and 800 mV. For example; a PMIC or MCU is internally 1.8V logic compatible, and requires a 1.2V V_{IH} and a 0.6V V_{IL}. Simply select SiT1552 NanoDrive factory programming code to be "D14" and the correct output thresholds will match the downstream PMIC or MCU input requirements. Interface logic will vary by manufacturer and we recommend that you review the input voltage requirements for the input interface.

For DC-biased NanoDrive output configuration, the minimum V_{OL} is limited to 350mV and the maximum allowable swing (V_{OH} - V_{OL}) is 750 mV. For example, 1.1V V_{OH} and 400 mV V_{OL} is acceptable, but 1.2V V_{OH} and 400 mV V_{OL} is not acceptable.

When the output is interfacing to an XTAL input that is internally AC-coupled, the SiT1552 output can be factory programmed to match the input swing requirements. For example, if a PMIC or MCU input is internally AC-coupled and requires an 800 mV swing, then simply choose the SiT1552 NanoDrive programming code "AA8" in the part number. It is important to note that the SiT1552 does not include internal AC-coupling capacitors. Please see the [Part Number Ordering](#) section at the end of the datasheet for more information about the part number ordering scheme.

SiT1552 NanoDrive™

Figure 3 shows a typical output waveform of the SiT1552 (into a 10 pF load) when factory programmed for a 0.70V swing and DC bias (V_{OH}/V_{OL}) for 1.8V logic:

Example:

- NanoDrive™ part number coding: **D14**.
Example part number: SiT1552AI-JE-**D14**-32.768
- $V_{OH} = 1.1V$, $V_{OL} = 0.4V$ ($V_{-sw} = 0.70V$)

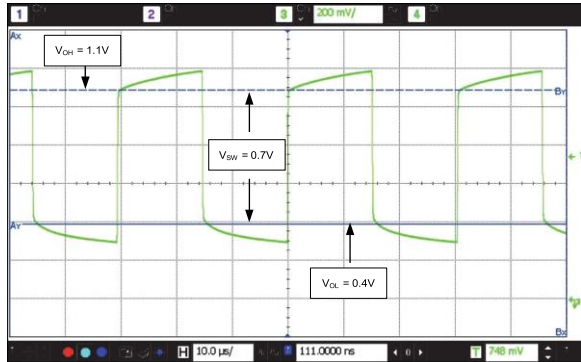

Figure 3. SiT1552AI-JE-D14-32.768 Output Waveform (10 pF load)

Table 4 shows the supported NanoDrive™ V_{OH} , V_{OL} factory programming options.

Table 4. Acceptable V_{OH}/V_{OL} NanoDrive™ Levels

NanoDrive	V_{OH} (V)	V_{OL} (V)	Swing (mV)	Comments
D26	1.2	0.6	600 ±55	1.8V logic compatible
D14	1.1	0.4	700 ±55	1.8V logic compatible
D74	0.7	0.4	300 ±55	XTAL compatible
AA3	n/a	n/a	300 ±55	XTAL compatible

The values listed in Table 4 are nominal values at 25°C and will exhibit a tolerance of ±55 mV across V_{dd} and -40°C to 85°C operating temperature range.

SiT1552 Full Swing LVCMOS Output

The SiT1552 can be factory programmed to generate full-swing LVCMOS levels. Figure 4 shows the typical waveform ($V_{dd} = 1.8V$) at room temperature into a 15 pF load.

Example:

- LVCMOS output part number coding is always **DCC**
- Example part number: SiT1552AI-JE-**DCC**-32.768

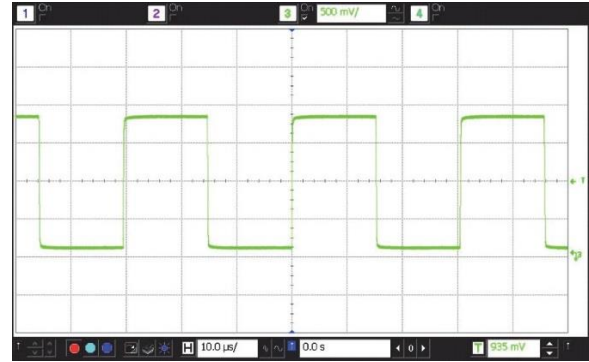

Figure 4. LVCMOS Waveform ($V_{dd} = 1.8V$) into 15 pF Load

Calculating Load Current

No Load Supply Current

When calculating no-load power for the SiT1552, the core and output driver components need to be added. Since the output voltage swing can be programmed to minimize load current, the output driver current is variable. Therefore, no-load operating supply current is broken into two sections; core and output driver. The equation is as follows:

Total Supply Current (no load) = I_{dd} Core + I_{dd} Output Driver

Example 1: Full-swing LVCMOS

- V_{dd} = 1.8V
 - I_{dd} Core = 990nA (typ)
 - V_{outpp} = 1.8V
 - I_{dd} Output Driver: (C_{driver})(V_{out})(F_{out}) = (3.5pF)(1.8V)(32768Hz) = 206nA
- Supply Current = 990nA + 206nA = 1.2μA

Example 2: NanoDrive™ Reduced Swing

- V_{dd} = 1.8V
 - I_{dd} Core = 990nA (typ)
 - V_{outpp} (D14) = V_{OH} - V_{OL} = 1.1V - 0.4V = 700mV
 - I_{dd} Output Driver: (C_{driver})(V_{out})(F_{out}) = (3.5pF)(0.7V)(32768Hz) = 80nA
- Supply Current = 990nA + 80nA = 1.07μA

Total Supply Current with Load

To calculate the total supply current, including the load, follow the equation listed below.

Total Current = I_{dd} Core + I_{dd} Output Driver + Load Current

Example 1: Full-swing LVCMOS

- V_{dd} = 1.8V
 - I_{dd} Core = 990nA
 - Load Capacitance = 10pF
 - I_{dd} Output Driver: (C_{driver})(V_{out})(F_{out}) = (3.5pF)(1.8V)(32768Hz) = 206nA
- Load Current: (10pF)(1.8V)(32768Hz) = 590nA
 Total Current = 990nA + 206nA + 590nA = 1.79μA

Example 2: NanoDrive™ Reduced Swing

- V_{dd} = 1.8V
 - I_{dd} Core = 990nA
 - Load Capacitance = 10pF
 - V_{outpp} (D14): V_{OH} - V_{OL} = 1.1V - 0.4V = 700mV
 - I_{dd} Output Driver: (C_{driver})(V_{out})(F_{out}) = (3.5pF)(0.7V)(32768Hz) = 80nA
- Load Current: (10pF)(0.7V)(32.768kHz) = 229nA
 Total Current = 990nA + 80nA + 229nA = 1.299μA

Typical Operating Curves

(T_A = 25°C, V_{dd} = 1.8V, unless otherwise stated)

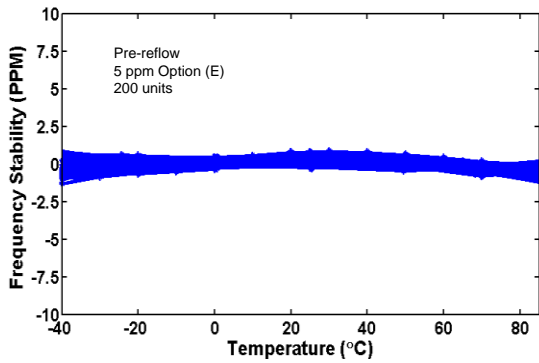

Figure 5. Frequency Stability Over Temperature (Pre-Reflow)

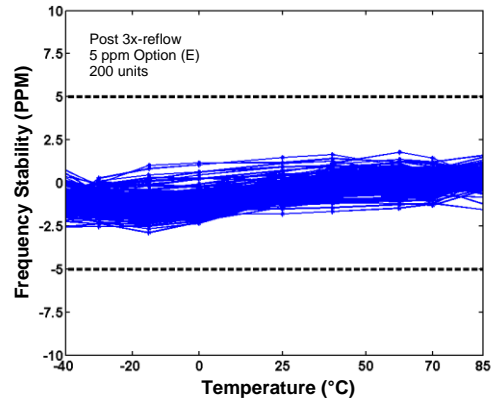

Figure 6. Frequency Stability Over Temperature (Post-Reflow)

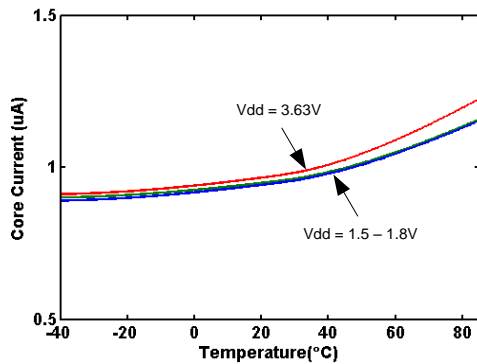

Figure 7. Core Current Over Temperature

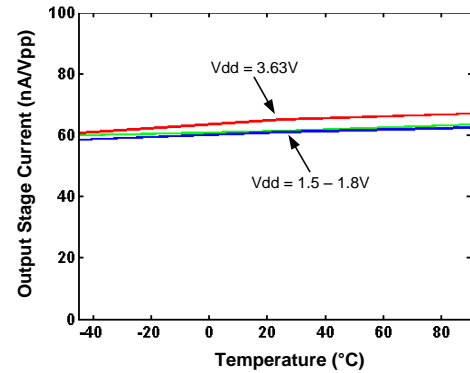

Figure 8. Output Stage Current Over Temperature

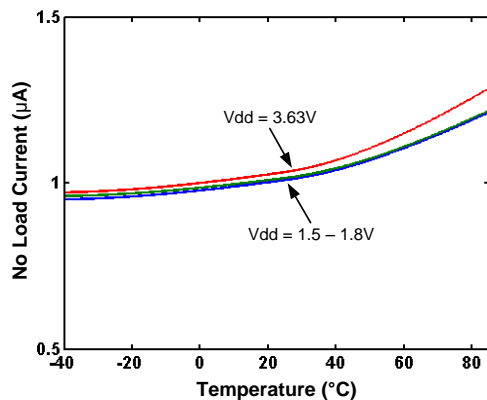

Figure 9. Total Supply Current Over Temperature, LVC MOS (Core + LVC MOS Output Driver, No Load)

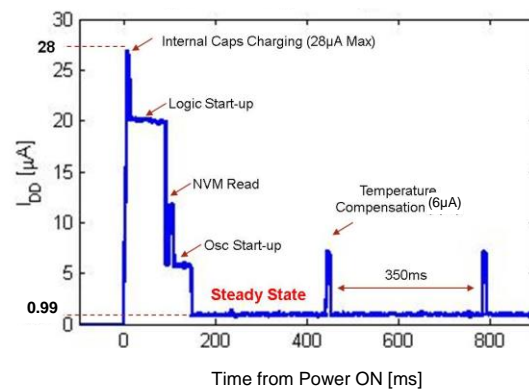

Figure 10. Start-up and Steady-State Current Profile

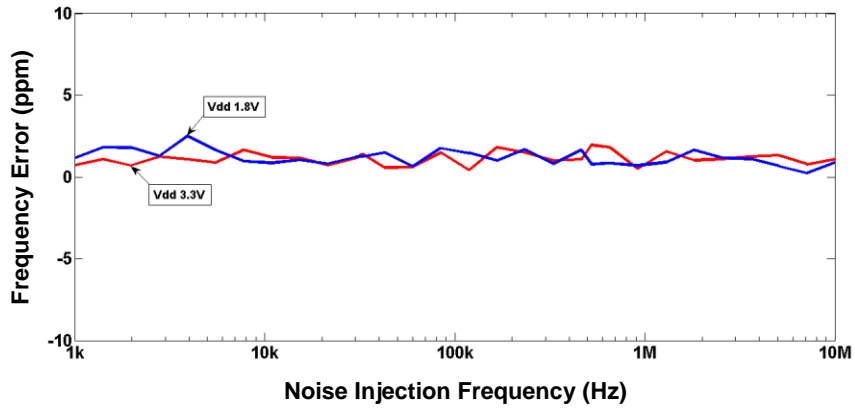

Figure 11. Power Supply Noise Rejection ($\pm 150\text{mV}$ Noise)

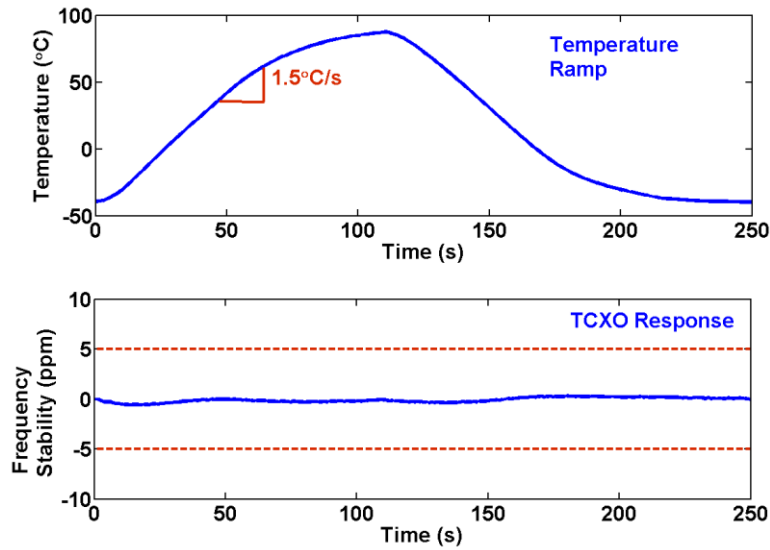

Figure 12. Temperature Ramp Response

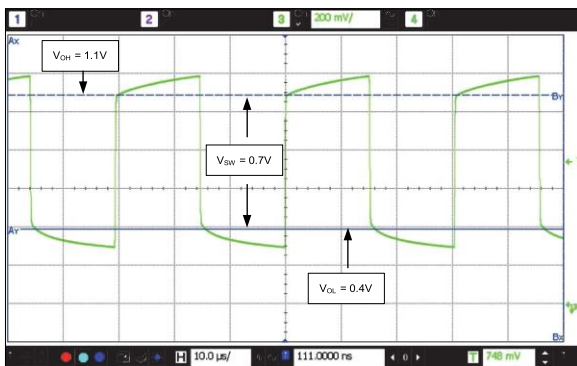

Figure 13. NanoDrive™ Output Waveform
($V_{OH} = 1.1\text{V}$, $V_{OL} = 0.4\text{V}$; SIT1552AI-JE-D14-32.768)

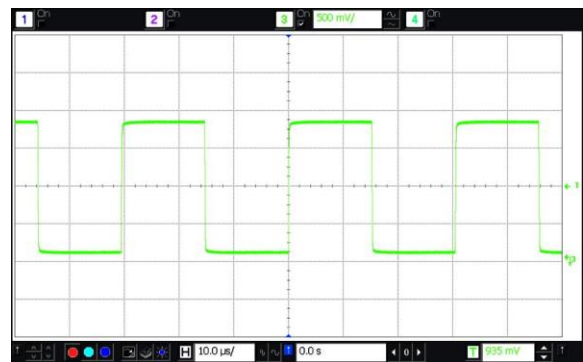

Figure 14. LVC MOS Output Waveform
($V_{Swing} = 1.8\text{V}$, SIT1552AI-JE-DCC-32.768, 10 pF Load)

Dimensions and Patterns

Package Size – Dimensions (Unit: mm)

Dimension Table (mm)				
Item	SYMBOL	MINIMUM	NOMINAL	MAXIMUM
Total Thickness	A	0.48	0.54	0.60
Stand Off	A1	0.22		0.28
MEMS Clearance	A2	0.027		0.113
Film Thickness	A3	0.036	0.040	0.044
Wafer Thickness	A4	0.225	0.250	0.275
Ball Diameter	b	0.30	0.315	0.33
Ball Pitch	X	e	0.41	BSC
	Y	e1	1.00	BSC
MEMS	X	D1	0.46	REF
	Y	E1	0.46	REF
Body Size	X	D	0.84	BSC
	Y	E	1.54	BSC
Ball To Center	X	SD	0.205	BSC
	Y	SE	0.500	BSC
Package Edge Tolerance	aaa		0.040	
Coplanarity	ccc		0.075	

4 LD – 1.5 x 0.8 x 0.55 mm	
Package Outline	
POD-35 Rev A	

Recommended Land Pattern (Unit: mm)

(soldermask openings shown with dashed line around NSMD pad)

Recommended 4-mil (0.1mm) stencil thickness

Manufacturing Guidelines

- 1) No Ultrasonic Cleaning: Do not subject the SiT1552 to an ultrasonic cleaning environment. Permanent damage or long term reliability issues to the MEMS structure may occur.
- 2) Do not apply underfill to the SiT1552. The device will not meet the frequency stability specification if underfill is applied.
- 3) Reflow profile, per JESD22-A113D.
- 4) For additional manufacturing guidelines and marking/tape-reel instructions, refer to: [SiTime Manufacturing Notes](#).

Ordering Information

Part number characters in blue represent the customer specific options. The other characters in the part number are fixed.

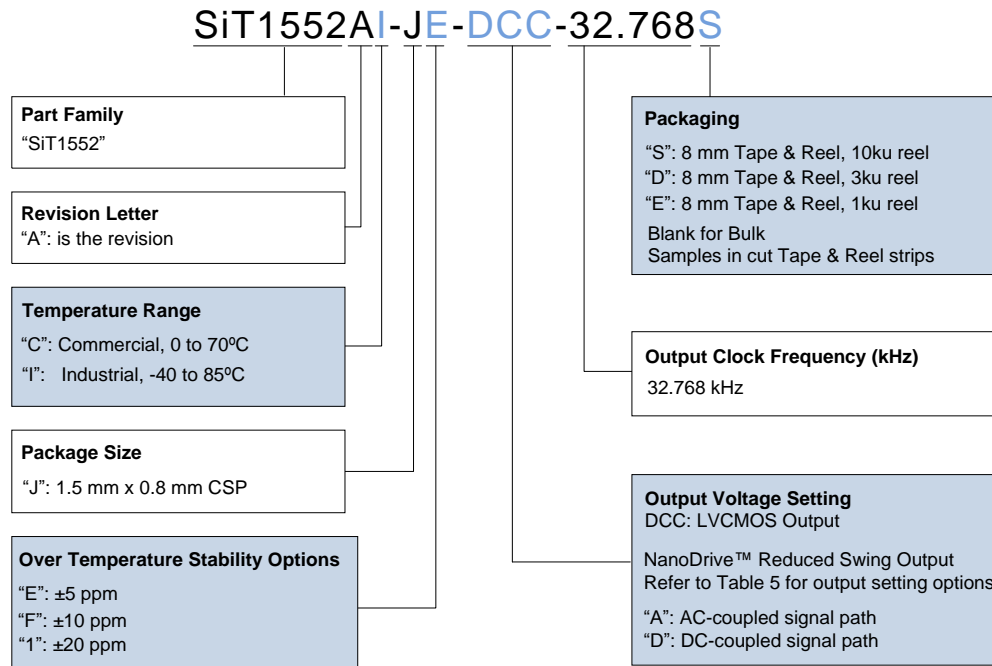

The following examples illustrate how to select the appropriate temp range and output voltage requirements:

Example 1: SiT1552AI-JE-DCC-32.768

- Industrial temperature range
- CSP package
- 5 ppm frequency stability over temp
- Output swing requirements:
 - a) Output frequency = 32.769 kHz
 - b) "D" = DC-coupled receiver
 - c) "C" = LVCMOS output swing
 - d) "C" = LVCMOS output swing

Example 2: SiT1552AC-JF-D14-32.768

- Commercial temperature range
- CSP package
- 10 ppm frequency stability over temp
- Output swing requirements:
 - a) Output frequency = 32.769 kHz
 - b) "D" = DC-coupled receiver
 - c) "1" = VOH = 1.1V
 - d) "4" = VOL = 400mV

Table 5. Acceptable V_{OH}/V_{OL} NanoDrive™ Levels^[4]

NanoDrive	V _{OH} (V)	V _{OL} (V)	Swing (mV)	Comments
D26	1.2	0.6	600 ±55	1.8V logic compatible
D14	1.1	0.4	700 ±55	1.8V logic compatible
D74	0.7	0.4	300 ±55	XTAL compatible
AA3	n/a	n/a	300 ±55	XTAL compatible

Note:

4. If these available options do not accommodate your application, contact [SiTime](http://www.sitime.com) for other NanoDrive options.

Table 6. Revision History

Version	Release Date	Change Summary
1.0	09/17/2014	Rev 0.9 Preliminary to Rev 1.0 Production Release Updated start-up time specification Added typical operating plots Removed SOT23 and 2012 SMD package options Added "no underfill" in frequency stability specification condition Added Manufacturing Guidelines section
1.1	10/14/2014	Improved Start-up Time at Power-up spec Added 5 pF LVCMOS rise/fall time spec
1.2	11/10/2014	Updated 5 pF LVCMOS rise/fall time spec
1.3	11/12/2015	Removed NanoDrive from EC Table and Ordering Info
1.31	01/18/2018	Updated SPL, page layout changes
1.32	03/15/2018	Updated POD (Package Outline Drawing) Updated logo and company address, other page layout changes
1.4	04/12/2018	Added the NanoDrive sections

SiTime Corporation, 5451 Patrick Henry Drive, Santa Clara, CA 95054, USA | **Phone:** +1-408-328-4400 | **Fax:** +1-408-328-4439

© SiTime Corporation 2014-2018. The information contained herein is subject to change at any time without notice. SiTime assumes no responsibility or liability for any loss, damage or defect of a Product which is caused in whole or in part by (i) use of any circuitry other than circuitry embodied in a SiTime product, (ii) misuse or abuse including static discharge, neglect or accident, (iii) unauthorized modification or repairs which have been soldered or altered during assembly and are not capable of being tested by SiTime under its normal test conditions, or (iv) improper installation, storage, handling, warehousing or transportation, or (v) being subjected to unusual physical, thermal, or electrical stress.

Disclaimer: SiTime makes no warranty of any kind, express or implied, with regard to this material, and specifically disclaims any and all express or implied warranties, either in fact or by operation of law, statutory or otherwise, including the implied warranties of merchantability and fitness for use or a particular purpose, and any implied warranty arising from course of dealing or usage of trade, as well as any common-law duties relating to accuracy or lack of negligence, with respect to this material, any SiTime product and any product documentation. Products sold by SiTime are not suitable or intended to be used in a life support application or component, to operate nuclear facilities, or in other mission critical applications where human life may be involved or at stake. All sales are made conditioned upon compliance with the critical uses policy set forth below.

CRITICAL USE EXCLUSION POLICY

BUYER AGREES NOT TO USE SITIME'S PRODUCTS FOR ANY APPLICATION OR IN ANY COMPONENTS USED IN LIFE SUPPORT DEVICES OR TO OPERATE NUCLEAR FACILITIES OR FOR USE IN OTHER MISSION-CRITICAL APPLICATIONS OR COMPONENTS WHERE HUMAN LIFE OR PROPERTY MAY BE AT STAKE.

SiTime owns all rights, title and interest to the intellectual property related to SiTime's products, including any software, firmware, copyright, patent, or trademark. The sale of SiTime products does not convey or imply any license under patent or other rights. SiTime retains the copyright and trademark rights in all documents, catalogs and plans supplied pursuant to or ancillary to the sale of products or services by SiTime. Unless otherwise agreed to in writing by SiTime, any reproduction, modification, translation, compilation, or representation of this material shall be strictly prohibited.

Компания «Океан Электроники» предлагает заключение долгосрочных отношений при поставках импортных электронных компонентов на взаимовыгодных условиях!

Наши преимущества:

- Поставка оригинальных импортных электронных компонентов напрямую с производств Америки, Европы и Азии, а так же с крупнейших складов мира;
- Широкая линейка поставок активных и пассивных импортных электронных компонентов (более 30 млн. наименований);
- Поставка сложных, дефицитных, либо снятых с производства позиций;
- Оперативные сроки поставки под заказ (от 5 рабочих дней);
- Экспресс доставка в любую точку России;
- Помощь Конструкторского Отдела и консультации квалифицированных инженеров;
- Техническая поддержка проекта, помощь в подборе аналогов, поставка прототипов;
- Поставка электронных компонентов под контролем ВП;
- Система менеджмента качества сертифицирована по Международному стандарту ISO 9001;
- При необходимости вся продукция военного и аэрокосмического назначения проходит испытания и сертификацию в лаборатории (по согласованию с заказчиком);
- Поставка специализированных компонентов военного и аэрокосмического уровня качества (Xilinx, Altera, Analog Devices, Intersil, Interpoint, Microsemi, Actel, Aeroflex, Peregrine, VPT, Syfer, Eurofarad, Texas Instruments, MS Kennedy, Miteq, Cobham, E2V, MA-COM, Hittite, Mini-Circuits, General Dynamics и др.);

Компания «Океан Электроники» является официальным дистрибьютором и эксклюзивным представителем в России одного из крупнейших производителей разъемов военного и аэрокосмического назначения «JONHON», а так же официальным дистрибьютором и эксклюзивным представителем в России производителя высокотехнологичных и надежных решений для передачи СВЧ сигналов «FORSTAR».



JONHON

«JONHON» (основан в 1970 г.)

Разъемы специального, военного и аэрокосмического назначения:

(Применяются в военной, авиационной, аэрокосмической, морской, железнодорожной, горно- и нефтедобывающей отраслях промышленности)

«FORSTAR» (основан в 1998 г.)

ВЧ соединители, коаксиальные кабели,
кабельные сборки и микроволновые компоненты:

(Применяются в телекоммуникациях гражданского и специального назначения, в средствах связи, РЛС, а так же военной, авиационной и аэрокосмической отраслях промышленности).



Телефон: 8 (812) 309-75-97 (многоканальный)

Факс: 8 (812) 320-03-32

Электронная почта: ocean@oceanchips.ru

Web: <http://oceanchips.ru/>

Адрес: 198099, г. Санкт-Петербург, ул. Калинина, д. 2, корп. 4, лит. А