



Typical Unit

| Output Voltage (Vdc) | Output Current (A) | Input Voltage Range (Vdc) |
|----------------------|--------------------|---------------------------|
| 3.3                  | 15.0               | 9 to 36                   |
| 5                    | 10.0               | 9 to 36                   |
| 12                   | 4.5                | 9 to 36                   |
| 15                   | 3.3                | 9 to 36                   |
| 24                   | 2.0                | 9 to 36                   |

## FEATURES

- High efficiency, up to 91%
- 9-36 Volts DC wide input range
- Single output of 3.3, 5, 12, 15 or 24 Volts
- Up to 54 Watts total output power
- 1.30 x 0.90" x 0.36" Open-frame package
- Industry standard DOSA sixteenth-brick format and pinout
- Small footprint DC-DC converter, ideal for high current applications
- Pre-bias start-up protection
- Trimmable outputs: 3.3Vout ( $\pm 10\%$ ), 5Vout, 12Vout, 15Vout and 24Vout ( $-20\%$ ,  $+10\%$ )
- Operating temperature range  $-40$  to  $+85^{\circ}\text{C}$  with derating
- Stable no-load operation with no required external components
- Certified to UL 60950-1, 2nd Edition, EN60950-1 safety approvals

## SAFETY FEATURES

- Basic insulation
- 2250Vdc, Input-to-Output isolation
- Over-temperature shutdown
- Extensive self-protection shut down features
- UL 60950-1, 2<sup>nd</sup> Edition
- CAN/CSA-C22.2 NO. 60950-1
- EN 60950-1
- RoHS compliant

## PRODUCT OVERVIEW

The world of "brick" DC-DC converters has seen a steady size reduction. The UWS-Q12 series makes another dramatic size shrink down to a "sixteenth brick" width (0.9 inches) while still retaining a high power output and full 2250 Volt DC I/O isolation. The converter family accepts 9 to 36 Volts DC inputs and delivers fixed regulated outputs. The UWS converters are ideal for mobile applications, datacom and telecom applications, cell phone towers, data centers, server farms and network repeaters.

The UWS outputs may be trimmed while delivering fast settling to current step loads and no adverse effects from higher capacitive loads. Excellent ripple and noise specifications assure compatibility to circuits using CPU's, ASIC's, programmable logic and FPGA's. No minimum load

is required. For systems requiring controlled startup/shutdown, the external remote On/Off control may use an open collector switch transistor.

Many self-protection features on the UWS-Q12 series avoid both converter and external circuit hazards. These include input undervoltage shutdown and overtemperature shutdown. The output of these DC-DC converters have current limit using the "hiccup" autorestart technique and the outputs may be short-circuited indefinitely. Additional features include output overvoltage and reverse conduction elimination.

The synchronous flyback topology yields high efficiency for minimal heat buildup and "no fan" operation.

## Open-Frame Through-Hole Package

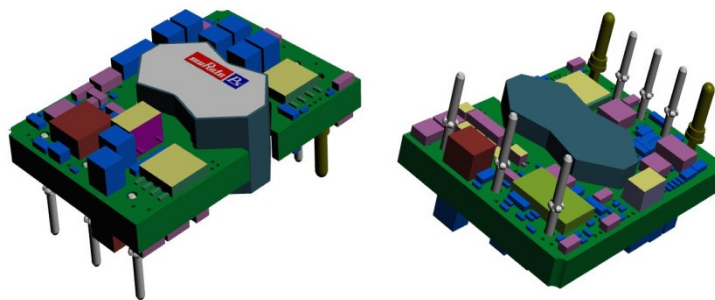

| PERFORMANCE SPECIFICATIONS SUMMARY AND ORDERING GUIDE ①② |                      |                            |           |                |      |                     |         |                          |           |                                |                                 |       |           |                    |
|--|----------------------|----------------------------|-----------|----------------|------|---------------------|---------|--------------------------|-----------|--------------------------------|---------------------------------|-------|-----------|--------------------|
| Root Model   | Output               |                            |           |                |      |                     | Input   |                          |           |                                | Efficiency                      |       | Package ④ |                    |
|  | V <sub>out</sub> (V) | I <sub>out</sub> (A, Max.) | Power (W) | R/N (mV pk-pk) |      | Regulation (Max.) ③ |         | V <sub>in</sub> Nom. (V) | Range (V) | I <sub>in</sub> , No Load (mA) | I <sub>in</sub> , Full Load (A) | Min.  | Typ.      | Case (inches)      |
|  |                      |                            |           | Typ.           | Max. | Line                | Load    |                          |           |                                |                                 |       |           |                    |
| UWS-3.3/15-Q12   | 3.3                  | 15.0                       | 49.5      | 60             | 75   | ±0.150%             | ±0.300% | 24                       | 9-36      | 30                             | 2.30                            | 87.5% | 89.5%     | 1.30 x 0.90 x 0.36 |
| UWS-5/10-Q12   | 5                    | 10.0                       | 50.0      | 40             | 75   | ±0.125%             | ±0.125% | 24                       | 9-36      | 25                             | 2.29                            | 89.0% | 91.0%     | 1.30 x 0.90 x 0.36 |
| UWS-12/4.5-Q12   | 12                   | 4.5                        | 54.0      | 100            | 130  | ±0.125%             | ±0.125% | 24                       | 9-36      | 30                             | 2.47                            | 89.5% | 91.0%     | 1.30 x 0.90 x 0.36 |
| UWS-15/3-Q12   | 15                   | 3.3                        | 49.5      | 110            | 150  | ±0.125%             | ±0.125% | 24                       | 9-36      | 65                             | 2.29                            | 89.5% | 91.0%     | 1.30 x 0.90 x 0.36 |
| UWS-24/2-Q12   | 24                   | 2.0                        | 48.0      | 140            | 240  | ±0.125%             | ±0.125% | 24                       | 9-36      | 130                            | 2.20                            | 89.0% | 91.0%     | 1.30 x 0.90 x 0.36 |

- ① Please refer to the Part Number Structure when ordering.
- ② All specifications are at nominal line voltage and full load, +25°C unless otherwise noted. See detailed specifications. Output capacitors are 1 µF ceramic multilayer in parallel with 10 µF and a 220 µF 100V capacitor across the input pins. I/O caps are necessary for our test equipment and may not be needed for your application.
- ③ Regulation specifications describe output voltage deviations from a nominal/midpoint value to either extreme (50% load step).
- ④ Please see the Mechanical Specifications for the Case Dimensions in [mm].

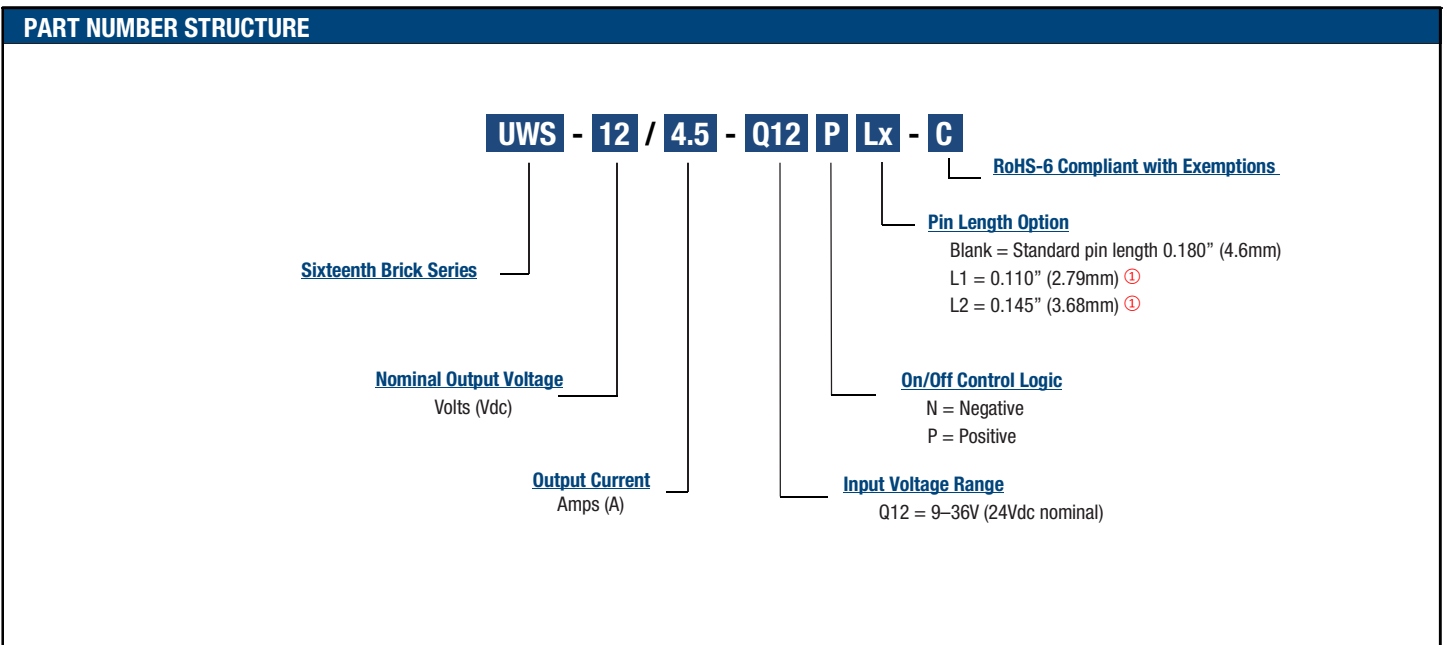

**Part Number Examples:**

**UWS-3.3/15-Q12N-C** stands for Sixteenth Brick, 3.3Vout @ 15A, 9-36Vin, Negative Logic, RoHS-6 Compliant.

**UWS-12/4.5-Q12P-C** stands for Sixteenth Brick, 12Vout @ 4.5A, 9-36Vin, Positive Logic, RoHS-6 Compliant.

- NOTES:**
- ① Special quantity order is required. Samples are only available with the standard pin length.
  - ② Some model number combinations may not be available. Please see our website or contact your local Murata Sales Representative.

## FUNCTIONAL SPECIFICATIONS, UWS-3.3/15-Q12

| ABSOLUTE MAXIMUM RATINGS  | Conditions [1]                                      | Minimum | Typical/Nominal | Maximum | Units |
|---------------------------|---|---------|-----------------|---------|-------|
| Input Voltage, Continuous | Full temperature range                              | 0       |                 | 36      | Vdc   |
| Input Voltage, Transient  | Operating or non-operating, 100 mS max. duration    |         |                 | 50      | Vdc   |
| Isolation Voltage         | Input to output tested                              |         |                 | 2250    | Vdc   |
| Input Reverse Polarity    | None, install external fuse                         |         | None            |         | Vdc   |
| On/Off Remote Control     | Power on or off, referred to -Vin                   | 0       |                 | 15      | Vdc   |
| Output Power              |   | 0       |                 | 50      | W     |
| Output Current            | Current-limited, no damage, short-circuit protected | 0       |                 | 15      | A     |
| Storage Temperature Range | Vin = Zero (no power)                               | -55     |                 | 125     | °C    |

Absolute maximums are stress ratings. Exposure of devices to greater than any of these conditions may adversely affect long-term reliability. Proper operation under conditions other than those listed in the Performance/Functional Specifications Table is not implied or recommended.

| INPUT                                      |   |     |           |      |           |
|--|---|-----|-----------|------|-----------|
| Operating voltage range                    |   | 9   | 24        | 36   | Vdc       |
| Recommended External Fuse                  | Fast blow                               |     |           | 10.0 | A         |
| Start-up threshold                         | Rising input voltage                    | 7.7 | 8.3       | 9.0  | Vdc       |
| Undervoltage shutdown [9]                  | Falling input voltage                   | 6.9 | 7.3       | 7.7  | Vdc       |
| Overvoltage shutdown                       | Rising input voltage                    |     | None      |      | Vdc       |
| Reverse Polarity Protection [11]           | None, install external fuse             |     | None      |      | Vdc       |
| Internal Filter Type                       |   |     | LC        |      |           |
| Input Current                              |   |     |           |      |           |
| Full Load Conditions                       | Vin = nominal                           |     | 2.30      | 2.38 | A         |
| Low Line                                   | Vin = minimum, 15A load                 |     | 6.21      | 6.42 | A         |
| Inrush Transient                           |   |     | 0.05      |      | A2-Sec.   |
| Output in Short Circuit                    |   |     | 50        | 100  | mA        |
| No Load Input current                      | Iout = minimum, unit=ON                 |     | 30        | 50   | mA        |
| Shut-Down mode Input Current (Off, UV, OT) |   |     | 1         | 2    | mA        |
| Reflected (back) ripple current [2]        | Measured at input with specified filter |     | 30        | 35   | mA, pk-pk |
| Reflected (back) ripple current            | No filtering                            |     | 250       | 300  | mA, pk-pk |
| Pre-biased startup                         | External output voltage < Vset          |     | Monotonic |      |           |

| GENERAL and SAFETY                 |  |      |       |  |                         |
|------------------------------------|--|------|-------|--|-------------------------|
| Efficiency                         | Vin=9V, full load  | 86.5 | 88.5  |  | %                       |
|                                    | Vin=24V, full load   | 87.5 | 89.5  |  | %                       |
| Isolation                          |  |      |       |  |                         |
| Isolation Voltage, Input to Output |  | 2250 |       |  | Vdc                     |
| Insulation Safety Rating           |  |      | Basic |  |                         |
| Isolation Resistance               |  | 10   |       |  | MΩ                      |
| Isolation Capacitance              |  |      | 1000  |  | pF                      |
| Safety                             | Certified to UL-60950-1, IEC/EN60950-1, 2nd Edition                            |      | Yes   |  |                         |
| Calculated MTBF [3]                | Per Telcordia SR-332, Issue 3, Case 3, Ground Benign controlled, Tambient=40°C |      | 11.5  |  | Hours x 10 <sup>6</sup> |

| DYNAMIC CHARACTERISTICS     |   |     |      |      |      |
|-----------------------------|---|-----|------|------|------|
| Fixed Switching Frequency   |   | 225 | 275  | 325  | kHz  |
| Power Up Startup Time       | Power On to Vout regulated                              |     |      | 20   | mS   |
| On/Off Startup Time         | Remote On to Vout regulated                             |     |      | 20   | mS   |
| Dynamic Load Response       | 50-75-50% load step, settling time to within 1% of Vout |     | 100  | 200  | μSec |
| Dynamic Load Peak Deviation | Same as above,  |     | ±180 | ±240 | mV   |

| FEATURES and OPTIONS      |                                     |      |   |     |     |
|---------------------------|-------------------------------------|------|---|-----|-----|
| Remote On/Off Control [4] |                                     |      |   |     |     |
| "N" suffix                |                                     |      |   |     |     |
| Negative Logic, ON state  | ON=Pin grounded or external voltage | -0.1 |   | 0.8 | Vdc |
| Negative Logic, OFF state | OFF=Pin open or external voltage    | 2.5  |   | 15  | Vdc |
| Control Current           | Open collector/drain, sourcing      |      | 1 | 2   | mA  |
| "P" suffix                |                                     |      |   |     |     |
| Positive Logic, ON state  | ON=Pin open or external voltage     | 10   |   | 15  | Vdc |
| Positive Logic, OFF state | OFF=Ground pin or external voltage  | 0    |   | 0.7 | Vdc |
| Control Current           | Open collector/drain                |      | 1 | 2   | mA  |

## FUNCTIONAL SPECIFICATIONS, UWS-3.3/15-Q12 (CONT.)

| OUTPUT   | Conditions [1]                                     | Minimum | Typical/Nominal    | Maximum | Units         |
|--|--|---------|--------------------|---------|---------------|
| <b>Total Output Power</b>                                      | See Derating                                       | 0.0     | 49.5               | 49.9    | W             |
| <b>Voltage</b>   |  |         |                    |         |               |
| <b>Nominal Output Voltage</b>                                  | No trim  | 3.267   | 3.30               | 3.333   | Vdc           |
| <b>Setting Accuracy</b>  | At 50% load  |         | 1                  |         | % of Vnom.    |
| <b>Output Voltage Range [6]</b>                                | User-adjustable                                    | -10     |                    | 10      | % of Vnom.    |
| <b>Overvoltage Protection [8]</b>                              | Via magnetic feedback                              | 4       | 4.5                | 5.0     | Vdc           |
| <b>Current</b>   |  |         |                    |         |               |
| <b>Output Current Range</b>                                    | Vin=9V-36V   | 0.0     |                    | 15.0    | A             |
| <b>Minimum Load</b>  |  |         | No minimum load    |         |               |
| <b>Current Limit Inception</b>                                 | 98% of Vnom., after warmup                         | 16.5    | 22.5               | 24.5    | A             |
| <b>Short Circuit</b>   |  |         |                    |         |               |
| <b>Short Circuit Current</b>                                   | Hiccup technique, autorecovery within 1.0% of Vout |         | 0.6                |         | A             |
| <b>Short Circuit Duration (remove short for recovery)</b>      | Output shorted to ground, no damage                |         | Continuous         |         |               |
| <b>Short circuit protection method</b>                         | Current limiting                                   |         |                    |         |               |
| <b>Regulation [5]</b>  |  |         |                    |         |               |
| <b>Line Regulation</b>   | Vin=min. to max., Vout=nom., full load             |         |                    | ±0.15   | %             |
| <b>Load Regulation</b>   | Iout=min. to max., Vin=24V                         |         |                    | ±0.30   | %             |
| <b>Ripple and Noise [7][10]</b>                                | With a 1uF    10uF output caps                     |         | 60                 | 75      | mV pk-pk      |
| <b>Temperature Coefficient</b>                                 | At all outputs                                     |         | 0.02               |         | % of Vnom./°C |
| <b>Remote Sense Compensation</b>                               | Sense connected at load                            |         |                    | 10      | % of Vout     |
| <b>Maximum Capacitive Load</b>                                 | Constant resistance mode, low ESR                  | 0       | 10,000             |         | µF            |
| <b>MECHANICAL</b>  |  |         |                    |         |               |
| <b>Outline Dimensions</b>                                      |  |         | 1.30 x 0.90 x 0.36 |         | Inches        |
| <b>(Please refer to outline drawing)</b>                       | L x W x H  |         | 33.0 x 22.9 x 9.1  |         | mm            |
| <b>Weight</b>  |  |         | 0.48               |         | Ounces        |
|  |  |         | 13.6               |         | Grams         |
| <b>Through Hole Pin Diameter</b>                               |  |         | 0.060 & 0.040      |         | Inches        |
|  |  |         | 1.52 & 1.02        |         | mm            |
| <b>Through Hole Pin Material</b>                               |  |         | Copper alloy       |         |               |
| <b>EMI/RFI Shielding</b>                                       |  |         | None               |         |               |
| <b>ENVIRONMENTAL</b>   |  |         |                    |         |               |
| <b>Operating Ambient Temperature Range</b>                     | See derating, full power, natural convection       | -40     |                    | 85      | °C            |
| <b>Operating Case Temperature Range</b>                        | No derating, full power, natural convection        | -40     |                    | 105     | °C            |
| <b>Storage Temperature</b>                                     | Vin = Zero (no power)                              | -55     |                    | 125     | °C            |
| <b>Thermal Protection/Shutdown</b>                             | Measured in center                                 | 115     | 125                | 130     | °C            |
| <b>Electromagnetic Interference Conducted, EN55022/CISPR22</b> | External filter is required                        |         | B                  |         | Class         |
| <b>RoHS rating</b>   |  |         | RoHS-6             |         |               |

## TYPICAL PERFORMANCE DATA, UWS-3.3/15-Q12

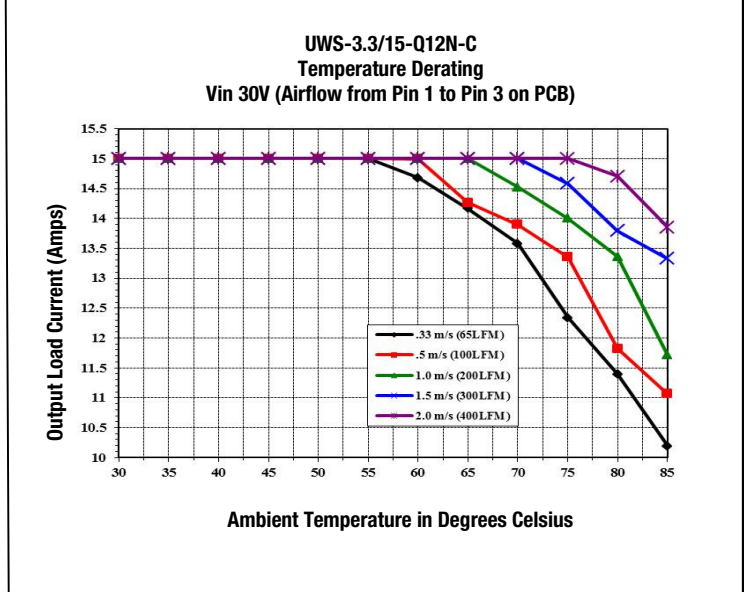
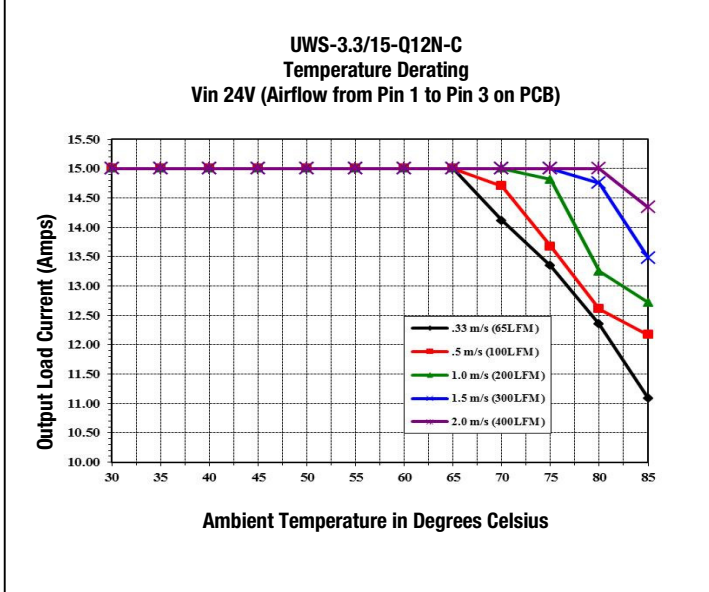
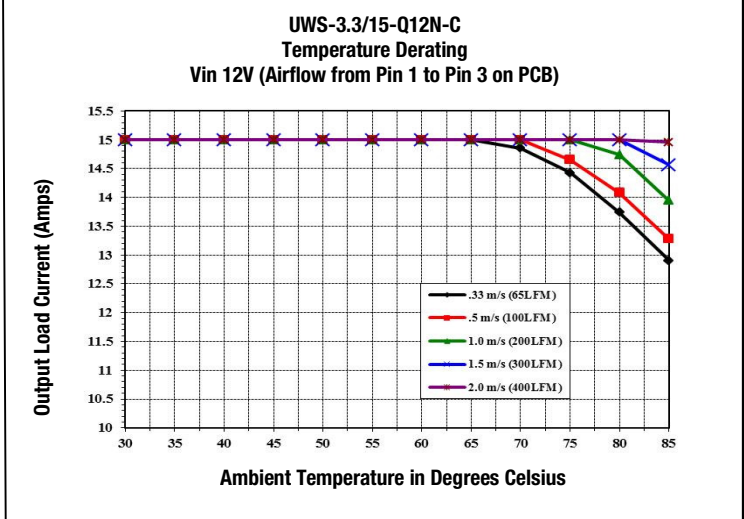
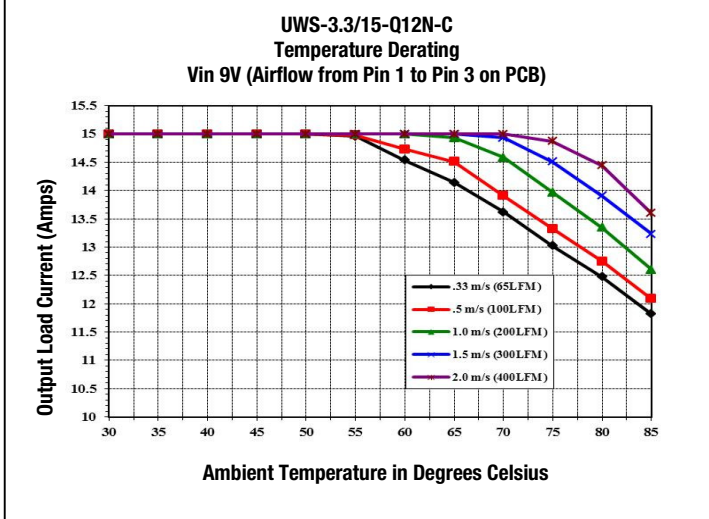
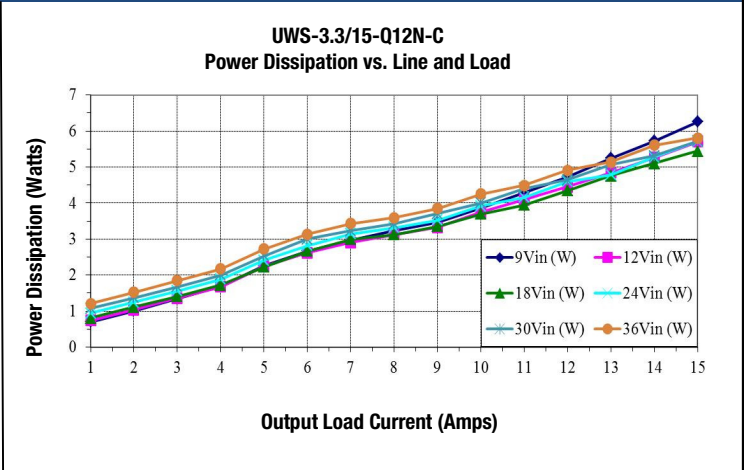
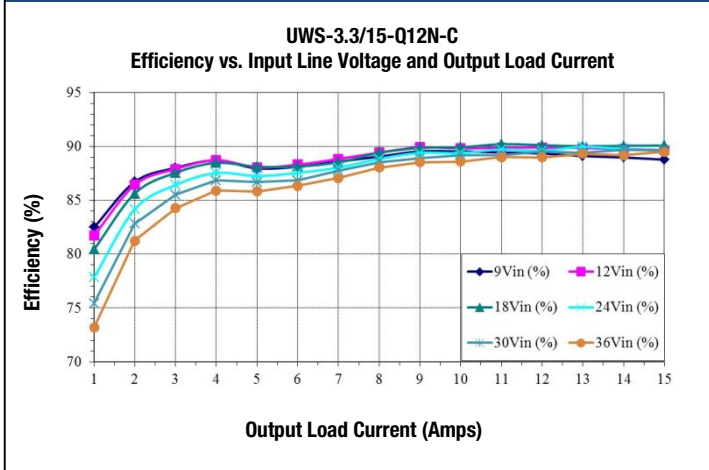

### TYPICAL PERFORMANCE DATA, UWS-3.3/15-Q12

Output Ripple and Noise (Vin=24V, Vout=nom., Iout=no load, Cload=1μF ceramic || 10μF tantalum, Ta=+25°C., ScopeBW=20MHz)

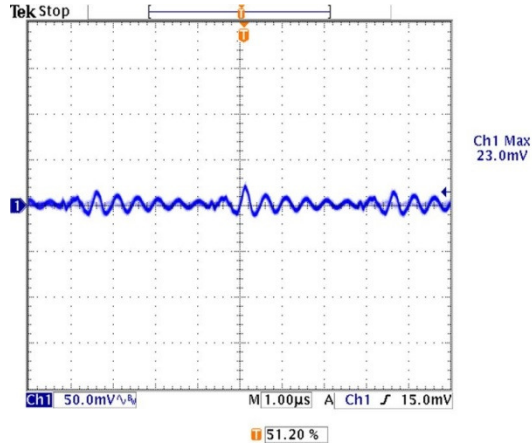

Output Ripple and Noise (Vin=24V, Vout=nom., Iout=15A, Cload=1μF ceramic || 10μF tantalum, Ta=+25°C., ScopeBW=20MHz)

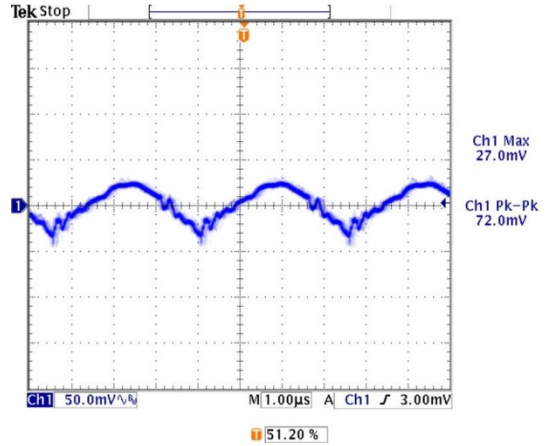

On/Off Enable Delay (Negative logic, Vin=24V, Vout=nom., Iout=no load, Cload=0 μF, Ta=+25°C., ScopeBW=20MHz) Trace 1=Enable, Trace 2=Vout

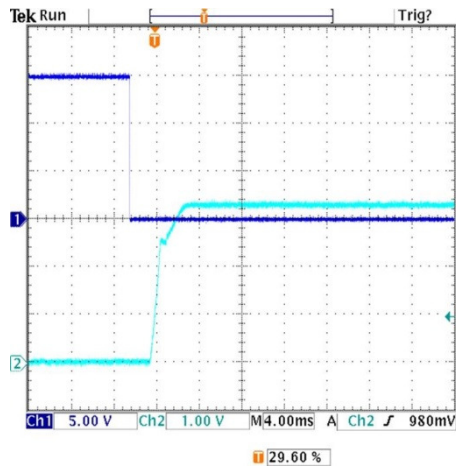

On/Off Enable Delay (Negative logic, Vin=24V, Vout=nom., Iout=15A, Cload=0 μF, Ta=+25°C., ScopeBW=20MHz) Trace 1=Enable, Trace 2=Vout

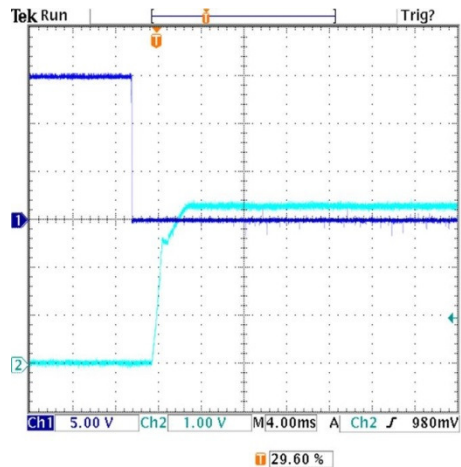

### TYPICAL PERFORMANCE DATA, UWS-3.3/15-Q12

Step Load Transient Response ( $V_{in}=24V$ ,  $V_{out}=nom.$ ,  $I_{out}=50-75-50\%$  of full load,  $C_{load}=1\mu F$  ceramic II  $10\mu F$  tantalum,  $T_a=+25^\circ C.$ , ScopeBW=20MHz)

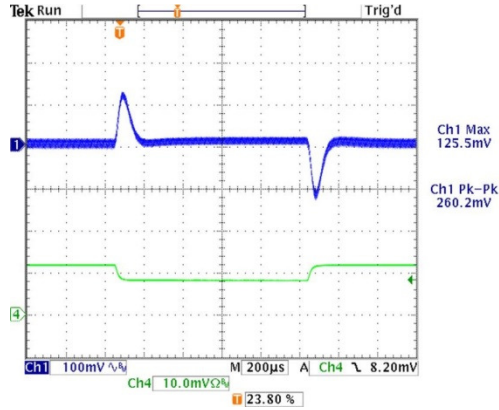

Step Load Transient Response ( $V_{in}=24V$ ,  $V_{out}=nom.$ ,  $I_{out}=50-75-50\%$  of full load,  $C_{load}=10000\mu F$ ,  $T_a=+25^\circ C.$ , ScopeBW=20MHz)

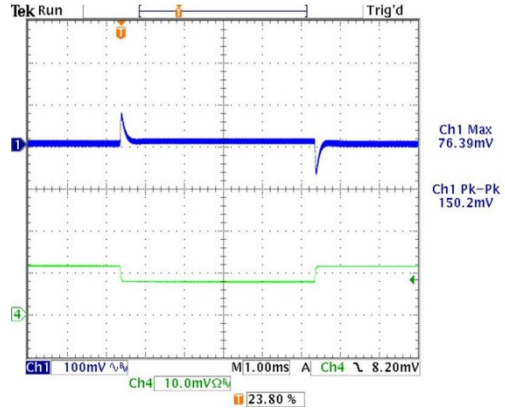

Power On Startup Delay ( $V_{in}=0$  to  $24V$ ,  $V_{out}=nom.$ ,  $I_{out}=no$  load,  $C_{load}=0\mu F$ ,  $T_a=+25^\circ C.$ , ScopeBW=20MHz) Trace 1= $V_{in}$ , Trace 2= $V_{out}$

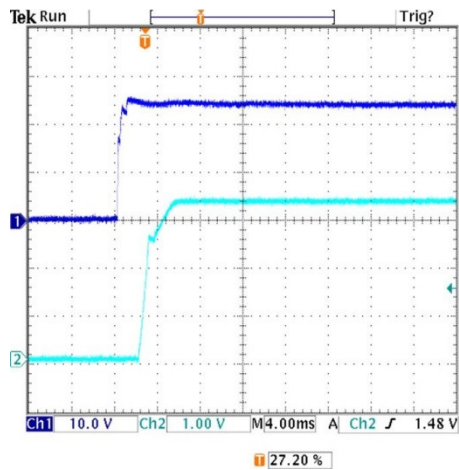

Power On Startup Delay ( $V_{in}=0$  to  $24V$ ,  $V_{out}=nom.$ ,  $I_{out}=15A$ ,  $C_{load}=0\mu F$ ,  $T_a=+25^\circ C.$ , ScopeBW=20MHz) Trace 1= $V_{in}$ , Trace 2= $V_{out}$

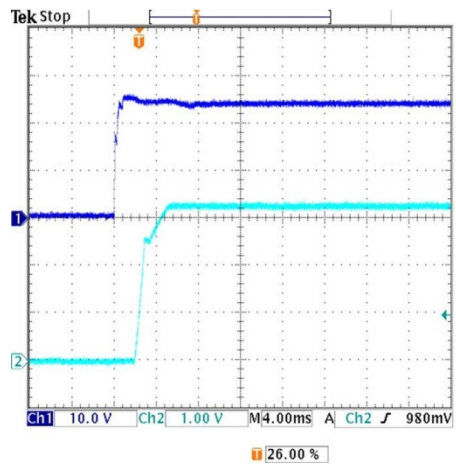

Pre-biased output voltage added connecting an external 10000uF to the output ( $V_{in}=24V$ ,  $I_{out}=0A$ ,  $+25^\circ C$ )

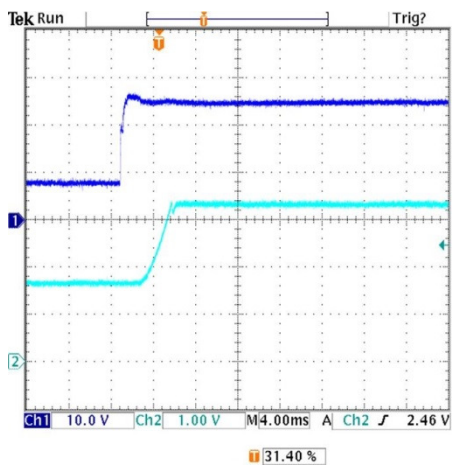

Pre-biased output voltage added connecting an external supply through a diode ( $V_{in}=24V$ ,  $I_{out}=0A$ ,  $+25^\circ C$ )

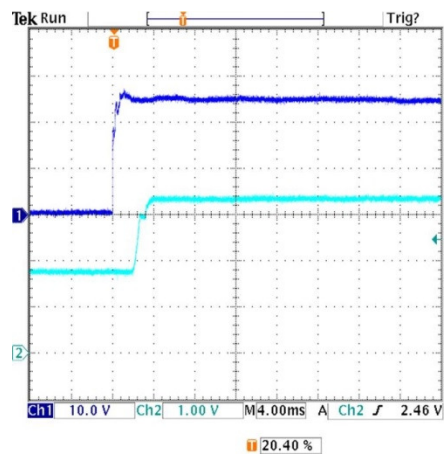

## FUNCTIONAL SPECIFICATIONS, UWS-5/10-Q12

| ABSOLUTE MAXIMUM RATINGS  | Conditions [1]  | Minimum | Typical/Nominal | Maximum | Units |
|---------------------------|---|---------|-----------------|---------|-------|
| Input Voltage, Continuous | Full temperature range                                      | 0       |                 | 36      | Vdc   |
| Input Voltage, Transient  | Operating or non-operating, tested:<br>100 mS max. duration | 0       |                 | 50      | Vdc   |
| Isolation Voltage         | Input to output   |         |                 | 2250    | Vdc   |
| Input Reverse Polarity    | None, install external fuse                                 |         | None            |         | Vdc   |
| On/Off Remote Control     | Power on, referred to -Vin                                  | 0       |                 | 15      | Vdc   |
| Output Power              |   | 0       |                 | 50.5    | W     |
| Output Current            | Current-limited, no damage, short-circuit protected         | 0       |                 | 10      | A     |
| Storage Temperature Range | Vin = Zero (no power)                                       | -55     |                 | 125     | °C    |

Absolute maximums are stress ratings. Exposure of devices to greater than any of these conditions may adversely affect long-term reliability. Proper operation under conditions other than those listed in the Performance/Functional Specifications Table is not implied or recommended.

| INPUT                               |   |     |           |      |         |
|-------------------------------------|---|-----|-----------|------|---------|
| Operating voltage range             |   | 9   | 24        | 36   | Vdc     |
| Recommended External Fuse           | Fast blow                               |     |           | 10.0 | A       |
| Start-up threshold, turn on         | Rising input voltage                    | 7.7 | 8.3       | 9.0  | Vdc     |
| Undervoltage shutdown, turn off [9] | Falling input voltage                   | 6.9 | 7.3       | 7.7  | Vdc     |
| Overvoltage shutdown                |   |     | NA        |      | Vdc     |
| Reverse Polarity Protection [11]    | None, install external fuse             |     | None      |      | Vdc     |
| Internal Filter Type                |   |     | LC        |      |         |
| Input Current                       |   |     |           |      |         |
| Full Load Conditions                | Vin = nominal                           |     | 2.29      | 2.36 | A       |
| Low Line                            | Vin = minimum                           |     | 6.21      | 6.38 | A       |
| Inrush Transient                    |   |     | 0.05      |      | A2-Sec. |
| Output in Short Circuit             |   |     | 50        | 100  | mA      |
| No Load Input Current               | Iout = minimum, unit=ON                 |     | 25        | 75   | mA      |
| Shut-Down Mode Input Current        |   |     | 5         | 10   | mA      |
| Reflected (back) ripple current [2] | Measured at input with specified filter |     | 30        | 35   | mAp-p   |
| Reflected (back) ripple current     | Measured at input without filter        |     | 250       | 300  | mAp-p   |
| Pre-biased startup                  | External output voltage < Vset          |     | Monotonic |      |         |

| GENERAL and SAFETY                        |  |      |       |  |                         |
|---|--|------|-------|--|-------------------------|
| Efficiency                                | Vin=9V, full load  | 88.0 | 89.5  |  | %                       |
|   | Vin=24V, full load   | 89.0 | 91.0  |  | %                       |
| Isolation                                 |  |      |       |  |                         |
| Isolation Voltage, Input to Output        |  | 2250 |       |  | Vdc                     |
| Insulation Safety Rating                  |  |      | Basic |  |                         |
| Isolation Resistance                      |  |      | 100   |  | MΩ                      |
| Isolation Capacitance                     |  |      | 1000  |  | pF                      |
| Safety (meets the following requirements) | UL-60950-1, CSA-C22.2 No.60950-1, IEC/EN60950-1, 2nd Edition                   |      | Yes   |  |                         |
| Calculated MTBF [3]                       | Per Telcordia SR-332, Issue 3, Case 3, Ground Benign controlled, Tambient=40°C |      | 10.5  |  | Hours x 10 <sup>6</sup> |

| DYNAMIC CHARACTERISTICS     |   |     |      |      |      |
|-----------------------------|---|-----|------|------|------|
| Fixed Switching Frequency   |   | 225 | 275  | 325  | kHz  |
| Startup Time                | Power On to Vout regulated                              |     |      | 30   | mS   |
| Startup Time                | Remote ON to Vout regulated                             |     |      | 30   | mS   |
| Dynamic Load Response       | 50-75-50% load step, settling time to within 1% of Vout |     | 100  | 200  | μSec |
| Dynamic Load Peak Deviation | Same as above,  |     | ±180 | ±240 | mV   |

| FEATURES and OPTIONS      |                                       |      |   |     |    |
|---------------------------|---------------------------------------|------|---|-----|----|
| Remote On/Off Control [4] |                                       |      |   |     |    |
| "N" suffix                |                                       |      |   |     |    |
| Negative Logic, ON state  | ON = Pin grounded or external voltage | -0.1 |   | 0.8 | V  |
| Negative Logic, OFF state | OFF = Pin open or external voltage    | 2.5  |   | 15  | V  |
| Control Current           | open collector/drain                  |      | 1 | 2   | mA |
| "P" suffix                |                                       |      |   |     |    |
| Positive Logic, ON state  | ON = Pin open or external voltage     | 10   |   | 15  | V  |
| Positive Logic, OFF state | OFF = Ground pin or external voltage  | 0    |   | 0.7 | V  |
| Control Current           | open collector/drain                  |      | 1 | 2   | mA |



## FUNCTIONAL SPECIFICATIONS, UWS-5/10-Q12 (CONT.)

| OUTPUT  | Conditions [1]                                   | Minimum | Typical/Nominal                                 | Maximum | Units         |
|---|--|---------|---|---------|---------------|
| Total Output Power                                  | See Derating                                     | 0.0     | 50  | 50.50   | W             |
| <b>Voltage</b>                                      |  |         |   |         |               |
| Nominal Output Voltage                              | No trim  | 4.95    | 5   | 5.05    | Vdc           |
| Setting Accuracy                                    | At 50% load                                      | -1.00   |   | 1.00    | % of Vset     |
| Output Voltage Range [6]                            | User-adjustable                                  | -20     |   | 10      |               |
| Overvoltage Protection [8]                          | Via magnetic feedback                            | 6.5     | 7.0   | 8.0     | Vdc           |
| <b>Current</b>                                      |  |         |   |         |               |
| Output Current Range                                | Vin=9V to 36V                                    | 0       |   | 10      |               |
| Minimum Load  |  |         | No minimum load                                 |         |               |
| Current Limit Inception                             | 98% of Vnom., after warmup                       | 11.50   | 14.50   | 16.0    | A             |
| <b>Short Circuit</b>                                |  |         |   |         |               |
| Short Circuit Current                               | Hiccup technique, autorecovery within 1% of Vout |         | 0.6   |         | A             |
| Short Circuit Duration (remove short for recovery)  | Output shorted to ground, no damage              |         | Continuous                                      |         |               |
| Short circuit protection method                     | Current limiting                                 |         |   |         |               |
| <b>Regulation [5]</b>                               |  |         |   |         |               |
| Line Regulation                                     | Vin=min. to max., Vout=nom., nom load            |         | ±0.125  |         | V             |
| Load Regulation                                     | Iout=min. to max                                 |         | ±0.125  |         | V             |
| Ripple and Noise [7][10]                            | With a 1uF    10 uF output caps.                 |         | 40  | 75      | mV pk-pk      |
| Temperature Coefficient                             | At all outputs                                   |         | 0.02  |         | % of Vout./°C |
| Remote Sense Compensation                           | Sense connected at load                          |         | 10  |         | % of Vout     |
| Maximum Capacitive Loading (10% ceramic, 90% Oscon) | Constant resistance mode , low ESR               | 0       | 5000  |         | µF            |
| <b>MECHANICAL</b>                                   |  |         |   |         |               |
| Outline Dimensions                                  |  |         | 1.30 x 0.90 x 0.36                              |         | Inches        |
| (Please refer to outline drawing)                   | L x W x H  |         | 33.0 x 22.9 x 9.1                               |         | mm            |
| Weight  |  |         | 0.48  |         | Ounces        |
|   |  |         | 13.6  |         | Grams         |
| Through Hole Pin Diameter                           | Diameter of pins standard                        |         | 0.060 & 0.040                                   |         | Inches        |
|   |  |         | 1.52 & 1.02                                     |         | mm            |
| Through Hole Pin Material                           |  |         | Gold-plated copper alloy with nickel underplate |         |               |
| TH Pin Plating Metal and Thickness                  | Nickel subplate                                  |         | 50  |         | µ-inches      |
|   | Gold overplate                                   |         | 5   |         | µ-inches      |
| EMI/RFI Shielding                                   |  |         | None  |         |               |
| <b>ENVIRONMENTAL</b>                                |  |         |   |         |               |
| Operating Ambient Temperature Range                 | See derating curves                              | -40     |   | 85      | °C            |
| Storage Temperature                                 | Vin = Zero (no power)                            | -55     |   | 125     | °C            |
| Operating Case Temp                                 | No derating required                             | -40     |   | 105     | °C            |
| Thermal Protection/Shutdown                         | Measured at hotspot                              | 115     | 125   | 130     | °C            |
| Electromagnetic Interference                        | External filter is required                      |         |   |         |               |
| Conducted, EN55022/CISPR22                          |  |         | B   |         | Class         |
| RoHS rating   |  |         | RoHS-6  |         |               |

## TYPICAL PERFORMANCE DATA, UWS-5/10-Q12

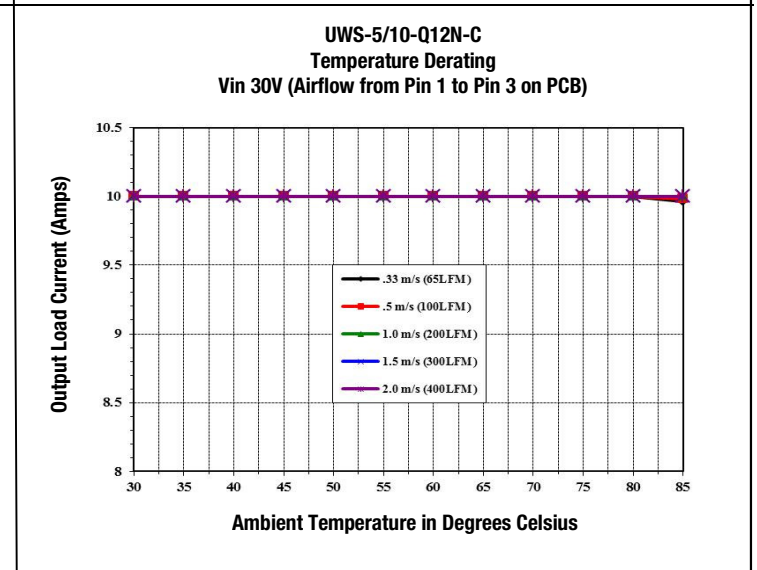
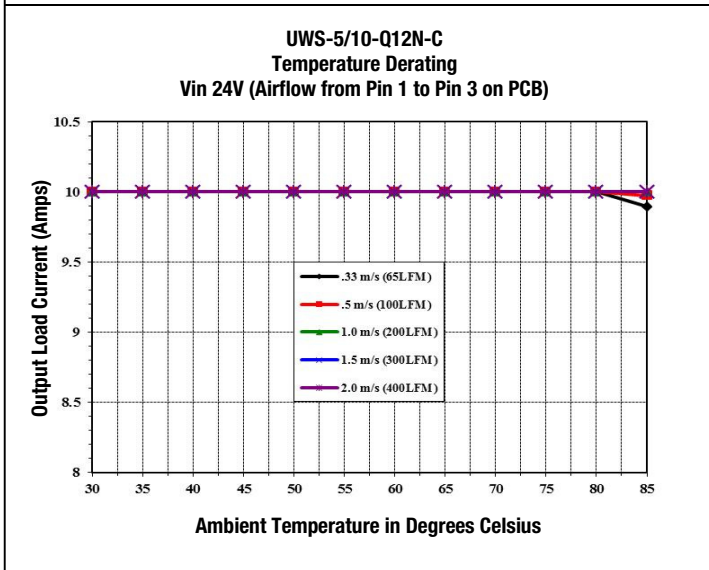
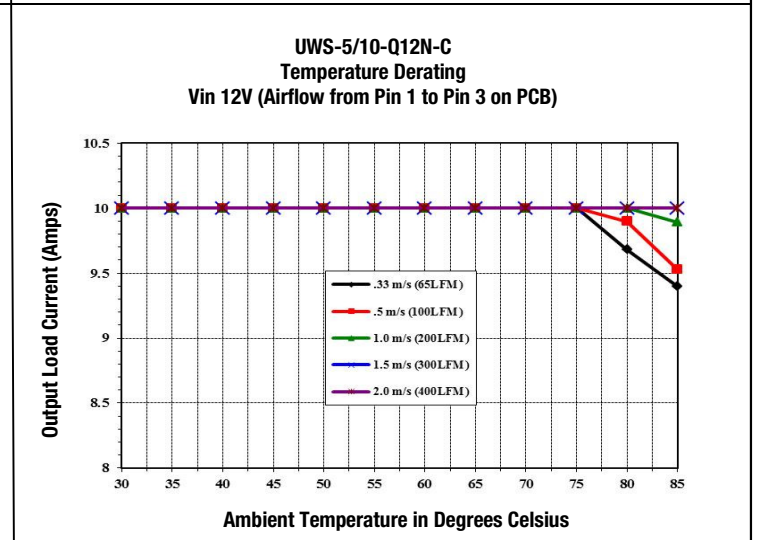
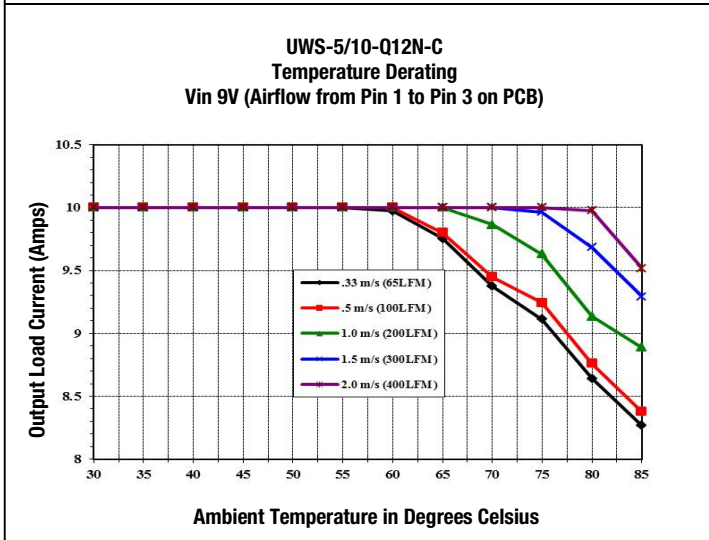
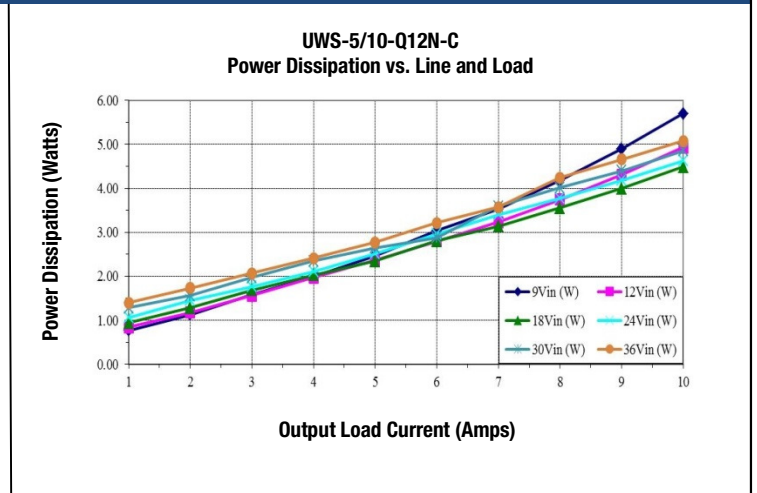
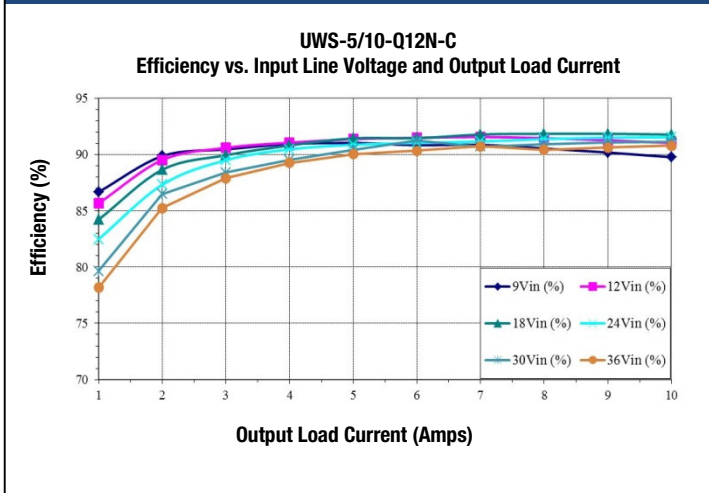

### TYPICAL PERFORMANCE DATA, UWS-5/10-Q12

Output Ripple and Noise ( $V_{in}=24V$ ,  $V_{out}=nom.$ ,  $I_{out}=no\ load$ ,  $C_{load}=1\mu F$  ceramic ||  $10\mu F$  tantalum,  $T_a=+25^{\circ}C.$ , ScopeBW=20MHz)

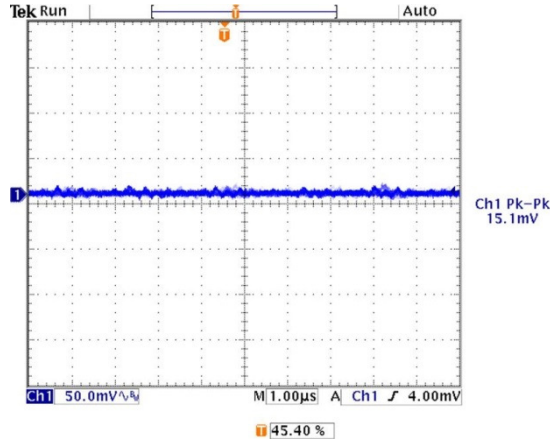

Output Ripple and Noise ( $V_{in}=24V$ ,  $V_{out}=nom.$ ,  $I_{out}=10A$ ,  $C_{load}=1\mu F$  ceramic ||  $10\mu F$  tantalum,  $T_a=+25^{\circ}C.$ , ScopeBW=20MHz)

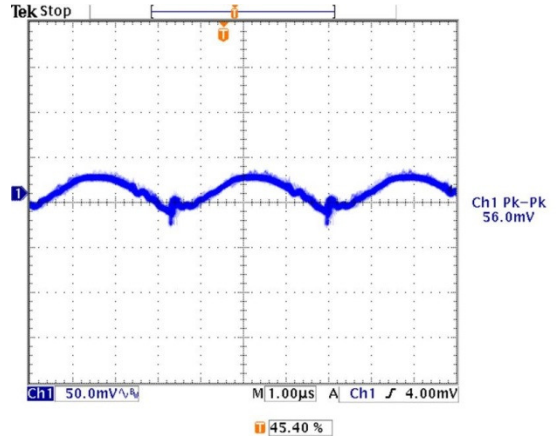

On/Off Enable Delay (Negative logic,  $V_{in}=24V$ ,  $V_{out}=nom.$ ,  $I_{out}=no\ load$ ,  $C_{load}=0\mu F$ ,  $T_a=+25^{\circ}C.$ , ScopeBW=20MHz) Trace 1=Enable, Trace 2=Vout

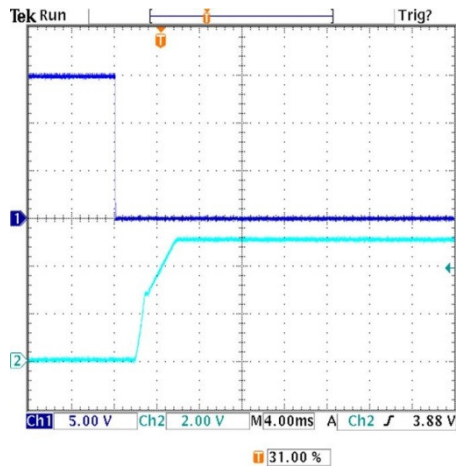

On/Off Enable Delay (Negative logic,  $V_{in}=24V$ ,  $V_{out}=nom.$ ,  $I_{out}=10A$ ,  $C_{load}=0\mu F$ ,  $T_a=+25^{\circ}C.$ , ScopeBW=20MHz) Trace 1=Enable, Trace 2=Vout

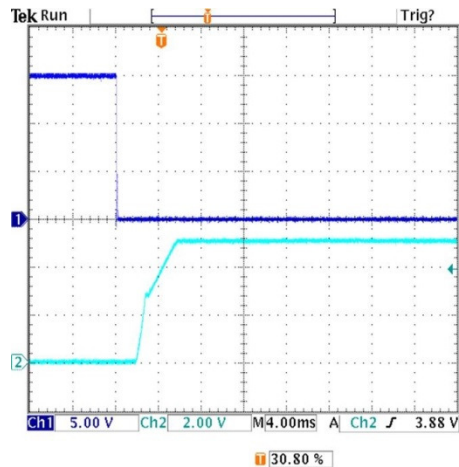

## TYPICAL PERFORMANCE DATA, UWS-5/10-Q12

Step Load Transient Response ( $V_{in}=24V$ ,  $V_{out}=nom.$ ,  $I_{out}=50-75-50\%$  of full load,  $C_{load}=1\mu F$  ceramic II  $10\mu F$  tantalum,  $T_a=+25^\circ C$ , ScopeBW=20MHz)

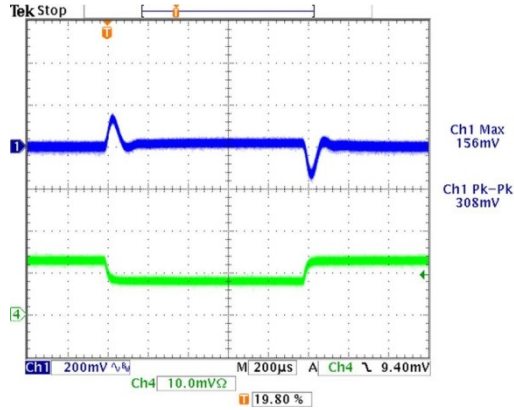

Step Load Transient Response ( $V_{in}=24V$ ,  $V_{out}=nom.$ ,  $I_{out}=50-75-50\%$  of full load,  $C_{load}=5000\mu F$ ,  $T_a=+25^\circ C$ , ScopeBW=20MHz)

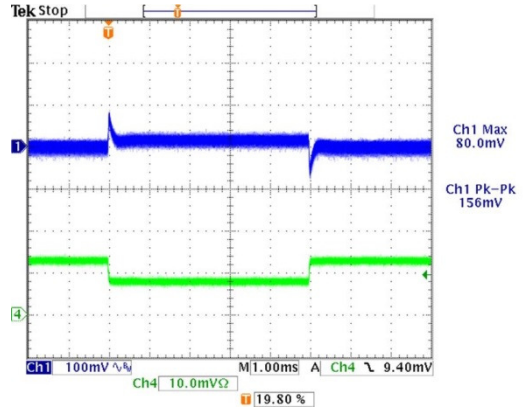

Power On Startup Delay ( $V_{in}=0$  to  $24V$ ,  $V_{out}=nom.$ ,  $I_{out}=no$  load,  $C_{load}=0\mu F$ ,  $T_a=+25^\circ C$ , ScopeBW=20MHz) Trace 1= $V_{in}$ , Trace 2= $V_{out}$

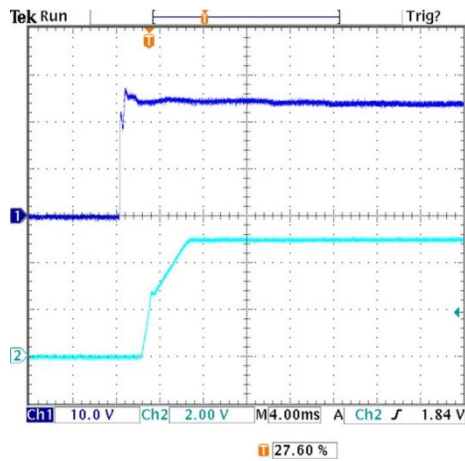

Power On Startup Delay ( $V_{in}=0$  to  $24V$ ,  $V_{out}=nom.$ ,  $I_{out}=10A$ ,  $C_{load}=0\mu F$ ,  $T_a=+25^\circ C$ , ScopeBW=20MHz) Trace 1= $V_{in}$ , Trace 2= $V_{out}$

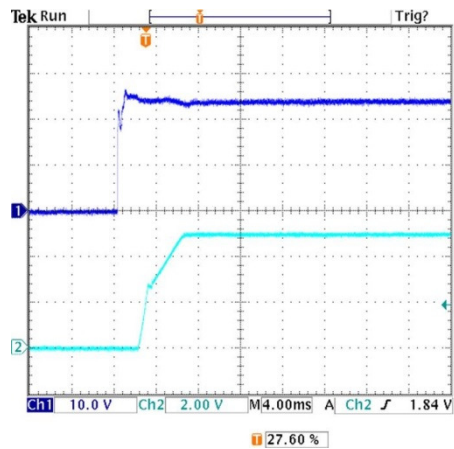

Pre-biased output voltage added connecting an external 5000uF to the output ( $V_{in}=24V$ ,  $I_{out}=0A$ ,  $+25^\circ C$ )

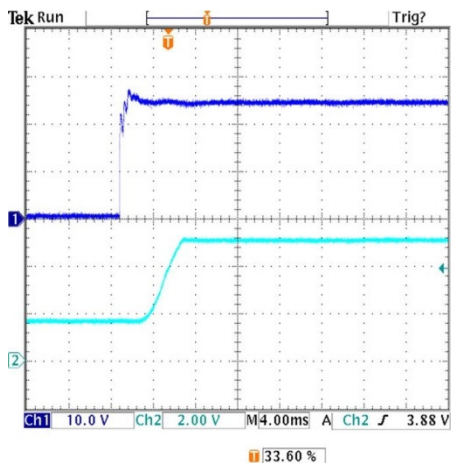

Pre-biased output voltage added connecting an external supply through a diode ( $V_{in}=24V$ ,  $I_{out}=0A$ ,  $+25^\circ C$ )

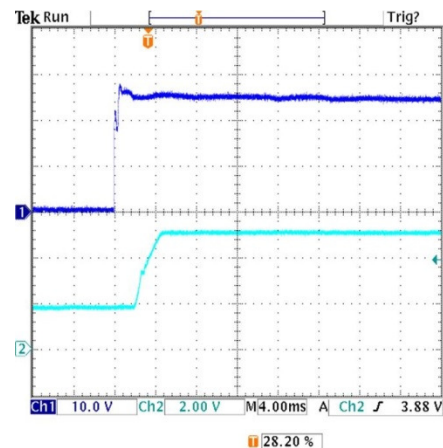

## FUNCTIONAL SPECIFICATIONS, UWS-12/4.5-Q12

| ABSOLUTE MAXIMUM RATINGS  | Conditions [1]                                      | Minimum | Typical/Nominal | Maximum | Units |
|---------------------------|---|---------|-----------------|---------|-------|
| Input Voltage, Continuous | Full temperature range                              | 0       |                 | 36      | Vdc   |
| Input Voltage, Transient  | Operating or non-operating, 100 mS max. duration    | 0       |                 | 50      | Vdc   |
| Isolation Voltage         | Input to output tested                              |         |                 | 2250    | Vdc   |
| Input Reverse Polarity    | None, install external fuse                         |         | None            |         | Vdc   |
| On/Off Remote Control     | Power on or off, referred to -Vin                   | 0       |                 | 15      | Vdc   |
| Output Power              |   | 0       |                 | 54.54   | W     |
| Output Current            | Current-limited, no damage, short-circuit protected | 0       |                 | 4.5     | A     |
| Storage Temperature Range | Vin = Zero (no power)                               | -55     |                 | 125     | °C    |

Absolute maximums are stress ratings. Exposure of devices to greater than any of these conditions may adversely affect long-term reliability. Proper operation under conditions other than those listed in the Performance/Functional Specifications Table is not implied or recommended.

| INPUT  |  |      |           |      |                         |
|--|--|------|-----------|------|-------------------------|
| Operating voltage range                              |  | 9    | 24        | 36   | Vdc                     |
| Recommended External Fuse                            | Fast blow  |      |           | 10.0 | A                       |
| Start-up threshold                                   | Rising input voltage   | 7.7  | 8.3       | 9.0  | Vdc                     |
| Undervoltage shutdown [9]                            | Falling input voltage  | 6.9  | 7.3       | 7.7  | Vdc                     |
| Overvoltage shutdown                                 | Rising input voltage   |      | None      |      | Vdc                     |
| Reverse Polarity Protection [11]                     | None, install external fuse  |      | None      |      | Vdc                     |
| Internal Filter Type                                 |  |      | LC        |      |                         |
| Input Current  |  |      |           |      |                         |
| Full Load Conditions                                 | Vin = nominal  |      | 2.47      | 2.54 | A                       |
| Low Line   | Vin = minimum , 4.5A load  |      | 6.59      | 6.77 | A                       |
| Inrush Transient                                     |  |      | 0.05      |      | A2-Sec.                 |
| Output in Short Circuit                              |  |      | 50        | 100  | mA                      |
| No Load Input Current                                | Iout = minimum, unit=ON  |      | 30        | 75   | mA                      |
| Shut-Down Mode Input Current (Off, UV, OT)           |  |      | 1         | 2    | mA                      |
| Reflected (back) ripple current [2]                  | Measured at input with specified filter  |      | 30        | 35   | mA, pk-pk               |
| Reflected (back) ripple current                      | Measured at input without filter   |      | 300       | 350  | mA, pk-pk               |
| Pre-biased startup                                   | External output voltage < Vset   |      | Monotonic |      |                         |
| GENERAL and SAFETY                                   |  |      |           |      |                         |
| Efficiency   | Vin=9V, full load  | 89.5 | 91.0      |      | %                       |
|  | Vin=24V, full load   | 89.5 | 91.0      |      | %                       |
| Isolation  |  |      |           |      |                         |
| Isolation Voltage, Input to Output                   |  | 2250 |           |      | Vdc                     |
| Insulation Safety Rating                             |  |      | Basic     |      |                         |
| Isolation Resistance                                 |  |      | 100       |      | MΩ                      |
| Isolation Capacitance                                |  |      | 1000      |      | pF                      |
| Safety (Designed to meet the following requirements) | UL-60950-1, IEC/EN60950-1, 2nd Edition   |      | Yes       |      |                         |
| Calculated MTBF [3]                                  | Per Telcordia SR-332, Issue 3, Case 3, Ground Benign controlled, Tambient=40°C |      | 7.77      |      | Hours x 10 <sup>6</sup> |
| DYNAMIC CHARACTERISTICS                              |  |      |           |      |                         |
| Fixed Switching Frequency                            |  | 225  | 275       | 325  | kHz                     |
| Power Up Startup Time                                | Power On to Vout regulated   |      |           | 30   | mS                      |
| On/Off Startup Time                                  | Remote ON to Vout regulated  |      |           | 30   | mS                      |
| Dynamic Load Response                                | 50-75-50% load step, settling time to within ±1% of Vout                       |      | 250       | 300  | µSec                    |
| Dynamic Load Peak Deviation                          | Same as above,   |      | ±350      | ±400 | mV                      |
| FEATURES and OPTIONS                                 |  |      |           |      |                         |
| Remote On/Off Control [4]                            |  |      |           |      |                         |
| "N" suffix   |  |      |           |      |                         |
| Negative Logic, ON state                             | ON=Pin grounded or external voltage  | -0.1 |           | 0.8  | Vdc                     |
| Negative Logic, OFF state                            | OFF=Pin open or external voltage   | 2.5  |           | 15   | Vdc                     |
| Control Current                                      | Open collector/drain, sourcing   |      | 1         | 2    | mA                      |
| "P" suffix   |  |      |           |      |                         |
| Positive Logic, ON state                             | ON=Pin open or external voltage  | 10   |           | 15   | Vdc                     |
| Positive Logic, OFF state                            | OFF=Pin grounded or external voltage   | 0    |           | 0.7  | Vdc                     |
| Control Current                                      | Open collector/drain, sinking  |      | 1         | 2    | mA                      |

## FUNCTIONAL SPECIFICATIONS, UWS-12/4.5-Q12 (CONT.)

| OUTPUT   | Conditions [1]                                       | Minimum | Typical/Nominal    | Maximum | Units         |
|--|--|---------|--------------------|---------|---------------|
| <b>Total Output Power</b>                          | See Derating   | 0       | 54                 | 54.54   | W             |
| <b>Voltage</b>                                     |  |         |                    |         |               |
| Nominal Output Voltage                             | No trim  | 11.88   | 12                 | 12.12   | Vdc           |
| Setting Accuracy                                   | At 50% load  |         | ±1                 |         | % of Vnom.    |
| Output Voltage Range [6]                           | User-adjustable                                      | -20     |                    | 10      | % of Vnom.    |
| Overvoltage Protection [8]                         | Via magnetic feedback                                | 15.0    | 16.5               | 18.0    | Vdc           |
| <b>Current</b>                                     |  |         |                    |         |               |
| Output Current Range                               | Vin=9V-36V   | 0       |                    | 4.5     | A             |
| Minimum Load                                       |  |         | No minimum load    |         |               |
| Current Limit Inception                            | 98% of Vnom., after warmup                           | 5.75    | 7.00               | 8.25    | A             |
| <b>Short Circuit</b>                               |  |         |                    |         |               |
| Short Circuit Current                              | Hiccup technique, autorecovery within ±1.25% of Vout |         | 0.6                |         | A             |
| Short Circuit Duration (remove short for recovery) | Output shorted to ground, no damage                  |         | Continuous         |         |               |
| Short circuit protection method                    | Current limiting                                     |         |                    |         |               |
| <b>Regulation [5]</b>                              |  |         |                    |         |               |
| Line Regulation                                    | Vin=min. to max., Vout=nom., full load               |         |                    | ±0.125  | %             |
| Load Regulation                                    | Iout=min. to max., Vin=24V                           |         |                    | ±0.125  | %             |
| Ripple and Noise [7][10]                           | with a 1uF    10uF output caps                       |         | 100                | 130     | mV pk-pk      |
| Temperature Coefficient                            | At all outputs                                       |         | ±0.02              |         | % of Vnom./°C |
| Remote Sense Compensation                          | Sense connected at load                              |         | 10                 |         | % of Vout     |
| Maximum Capacitive Load                            | Constant resistance mode, low ESR                    | 0       | 2200               |         | µF            |
| <b>MECHANICAL</b>                                  |  |         |                    |         |               |
| Outline Dimensions                                 |  |         | 1.30 x 0.90 x 0.36 |         | Inches        |
| (Please refer to outline drawing)                  | L x W x H  |         | 33.0 x 22.9 x 9.1  |         | mm            |
| Weight   |  |         | 0.48               |         | Ounces        |
|  |  |         | 13.6               |         | Grams         |
| Through Hole Pin Diameter                          |  |         | 0.060 & 0.040      |         | Inches        |
|  |  |         | 1.52 & 1.02        |         | mm            |
| Through Hole Pin Material                          |  |         | Copper alloy       |         |               |
| TH Pin Plating Metal and Thickness                 | Nickel subplate                                      |         | 50                 |         | µ-inches      |
|  | Gold overplate                                       |         | 5                  |         | µ-inches      |
| EMI/RFI Shielding                                  |  |         | None               |         |               |
| <b>ENVIRONMENTAL</b>                               |  |         |                    |         |               |
| Operating Ambient Temperature Range                | No derating, full power, natural convection          | -40     |                    | 85      | °C            |
| Operating Case Temperature Range                   | No derating, full power, natural convection          | -40     |                    | 105     | °C            |
| Storage Temperature                                | Vin = Zero (no power)                                | -55     |                    | 125     | °C            |
| Thermal Protection/Shutdown                        | Measured in center                                   | 115     | 125                | 130     | °C            |
| Electromagnetic Interference                       | External filter is required                          |         |                    |         |               |
| Conducted, EN55022/CISPR22                         |  |         | B                  |         | Class         |
| RoHS rating  |  |         | RoHS-6             |         |               |

## TYPICAL PERFORMANCE DATA, UWS-12/4.5-Q12

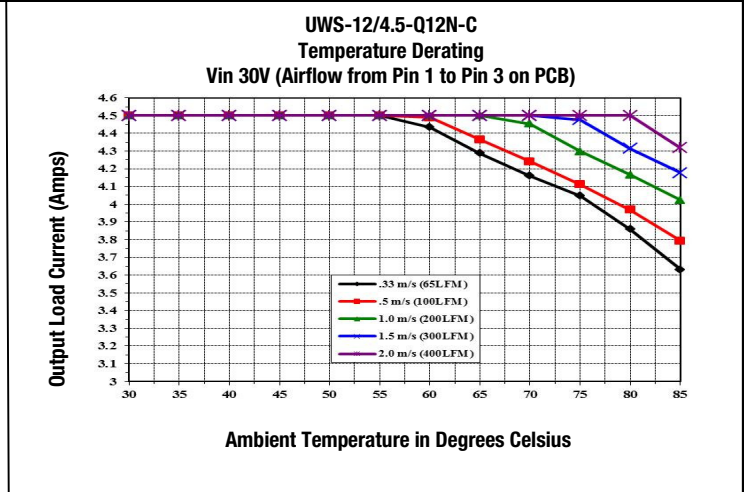
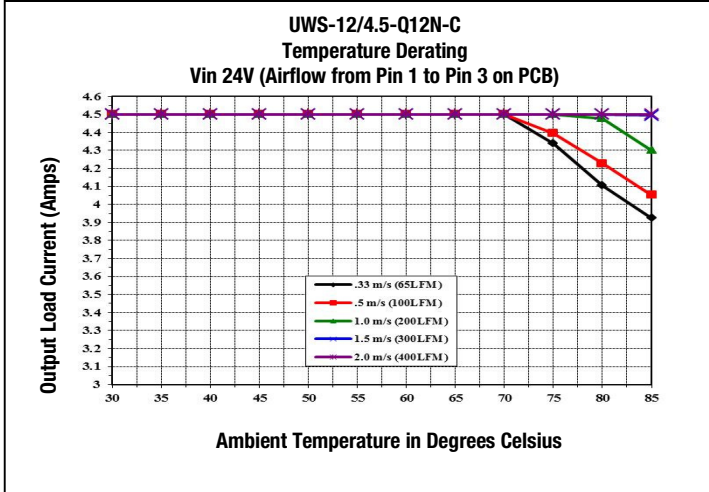
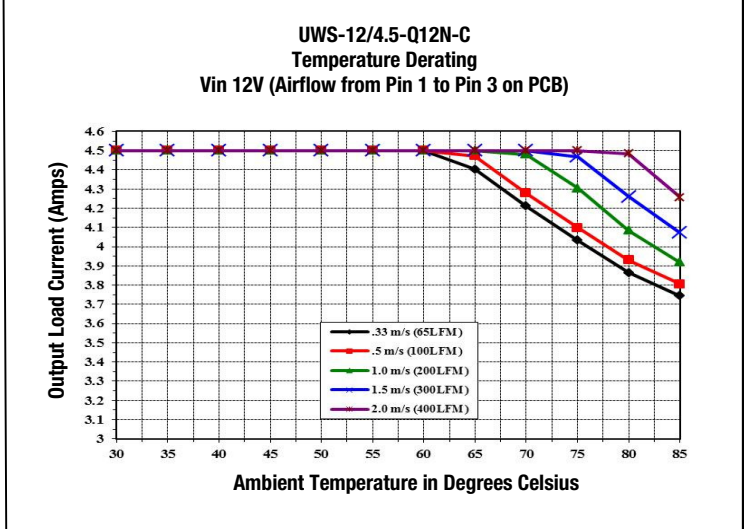
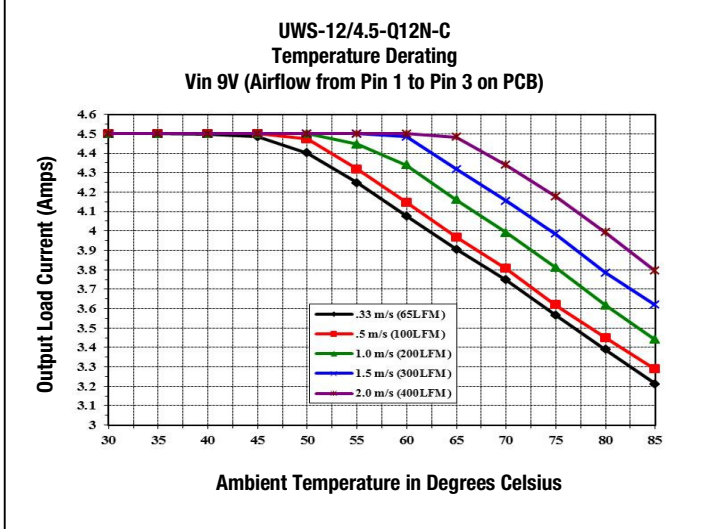
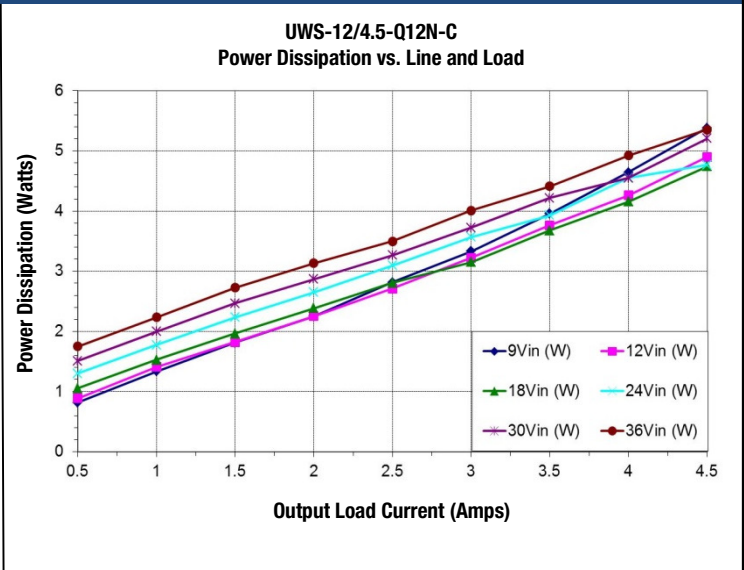
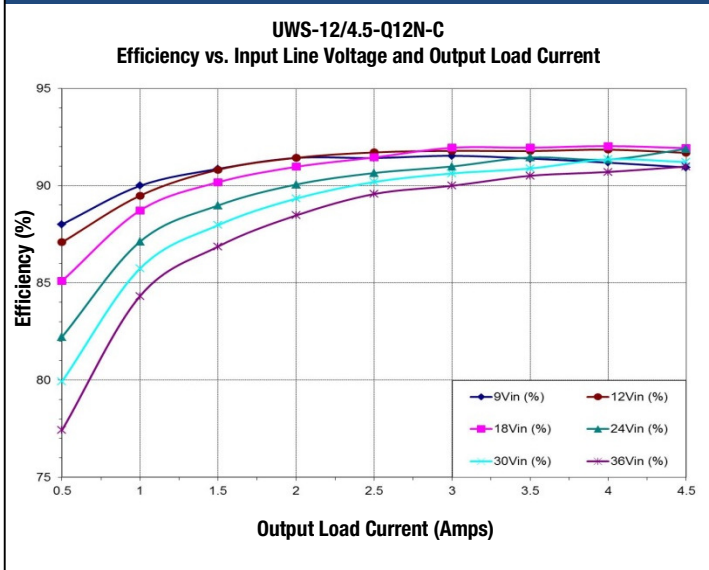

### TYPICAL PERFORMANCE DATA, UWS-12/4.5-Q12

Output Ripple and Noise (Vin=24V, Vout=nom., Iout=no load, Cload=1μF ceramic II 10μF tantalum, Ta=+25°C., ScopeBW=20MHz)

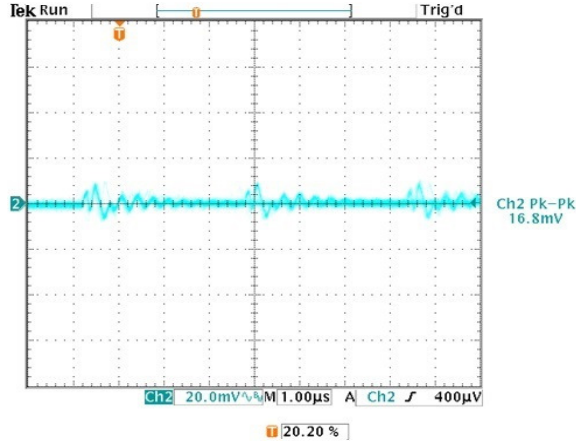

Output Ripple and Noise (Vin=24V, Vout=nom., Iout=4.5A, Cload=1μF ceramic II 10μF tantalum, Ta=+25°C., ScopeBW=20MHz)

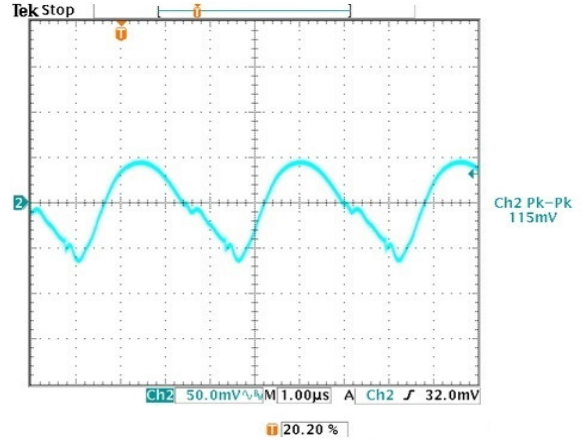

On/Off Enable Delay (Negative logic, Vin=24V, Vout=nom., Iout=no load, Cload=0 μF, Ta=+25°C., ScopeBW=20MHz) Trace 1=Enable, Trace 2=Vout

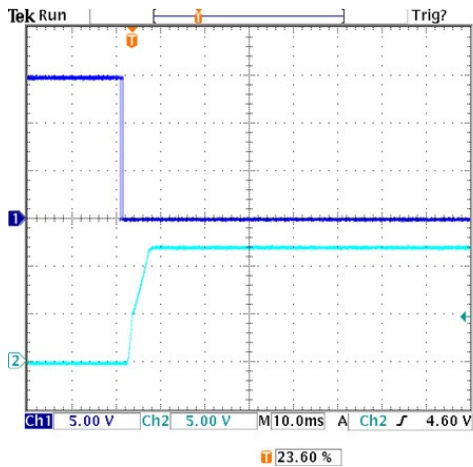

On/Off Enable Delay (Negative logic, Vin=24V, Vout=nom., Iout=4.5A, Cload=0 μF, Ta=+25°C., ScopeBW=20MHz) Trace 1=Enable, Trace 2=Vout

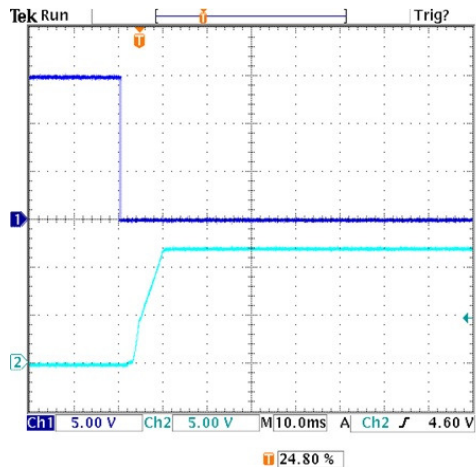



## TYPICAL PERFORMANCE DATA, UWS-12/4.5-Q12

Step Load Transient Response ( $V_{in}=24V$ ,  $V_{out}=nom.$ ,  $I_{out}=50-75-50\%$  of full load,  $C_{load}=1\mu F$  ceramic ||  $10\mu F$  tantalum,  $T_a=+25^\circ C.$ , ScopeBW=20MHz)

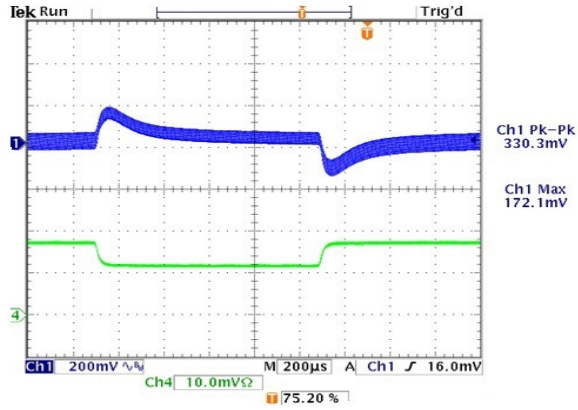

Step Load Transient Response ( $V_{in}=24V$ ,  $V_{out}=nom.$ ,  $I_{out}=50-75-50\%$  of full load,  $C_{load}=2000\mu F$ ,  $T_a=+25^\circ C.$ , ScopeBW=20MHz)

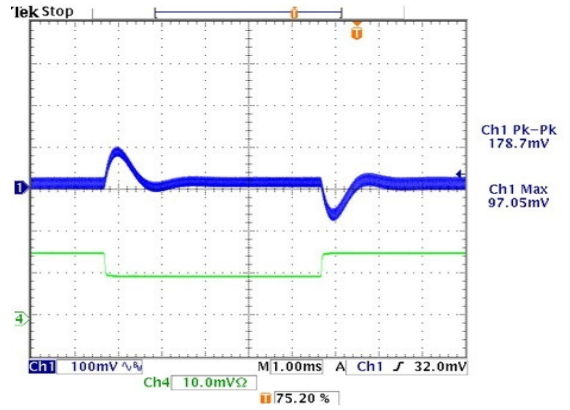

Power On Startup Delay ( $V_{in}=0$  to  $24V$ ,  $V_{out}=nom.$ ,  $I_{out}=no$  load,  $C_{load}=0\mu F$ ,  $T_a=+25^\circ C.$ , ScopeBW=20MHz) Trace 1= $V_{in}$ , Trace 2= $V_{out}$

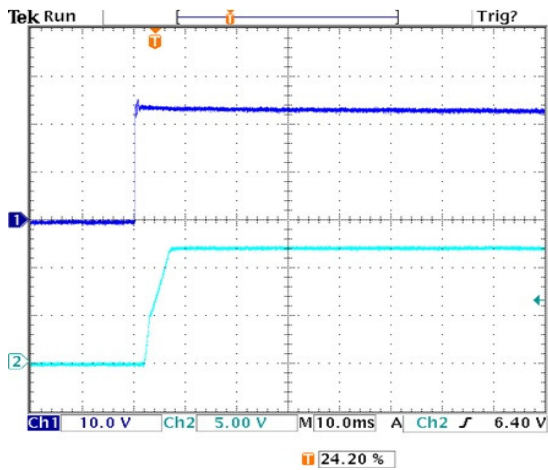

Power On Startup Delay ( $V_{in}=0$  to  $24V$ ,  $V_{out}=nom.$ ,  $I_{out}=4.5A$ ,  $C_{load}=0\mu F$ ,  $T_a=+25^\circ C.$ , ScopeBW=20MHz) Trace 1= $V_{in}$ , Trace 2= $V_{out}$

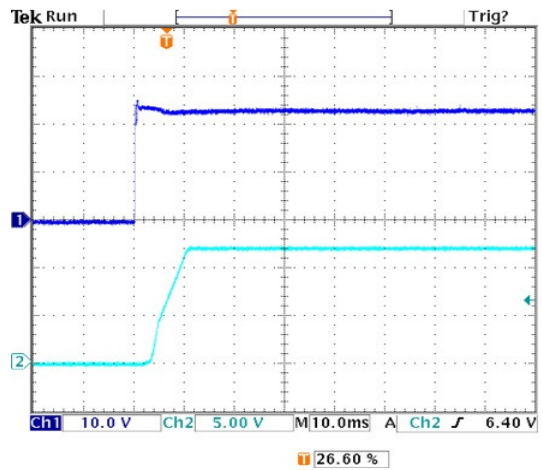

Pre-biased output voltage added connecting an external 2000uF to the output ( $V_{in}=24V$ ,  $I_{out}=0A$ ,  $+25^\circ C$ )

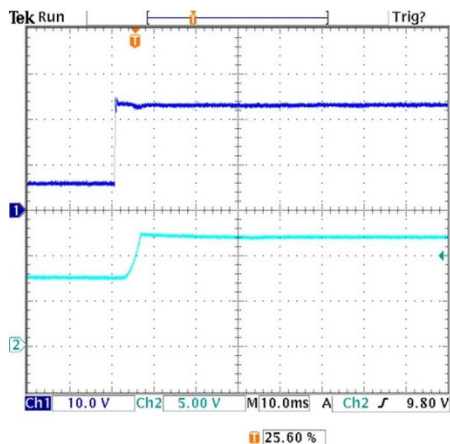

Pre-biased output voltage added connecting an external supply through a diode ( $V_{in}=24V$ ,  $I_{out}=0A$ ,  $+25^\circ C$ )

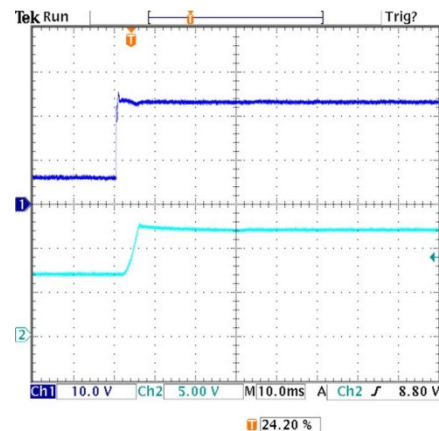

## FUNCTIONAL SPECIFICATIONS, UWS-15/3-Q12

| ABSOLUTE MAXIMUM RATINGS  | Conditions [1]                                      | Minimum | Typical/Nominal | Maximum | Units |
|---------------------------|---|---------|-----------------|---------|-------|
| Input Voltage, Continuous | Full temperature range                              | 0       |                 | 36      | Vdc   |
| Input Voltage, Transient  | Operating or non-operating, 100 mS max. duration    | 0       |                 | 50      | Vdc   |
| Isolation Voltage         | Input to output tested                              |         |                 | 2250    | Vdc   |
| Input Reverse Polarity    | None, install external fuse                         |         | None            |         | Vdc   |
| On/Off Remote Control     | Power on or off, referred to -Vin                   | 0       |                 | 15      | Vdc   |
| Output Power              |   | 0       |                 | 50      | W     |
| Output Current            | Current-limited, no damage, short-circuit protected | 0       |                 | 3.3     | A     |
| Storage Temperature Range | Vin = Zero (no power)                               | -55     |                 | 125     | °C    |

Absolute maximums are stress ratings. Exposure of devices to greater than any of these conditions may adversely affect long-term reliability. Proper operation under conditions other than those listed in the Performance/Functional Specifications Table is not implied or recommended.

| INPUT                                      |   |     |           |      |           |
|--|---|-----|-----------|------|-----------|
| Operating voltage range                    |   | 9   | 24        | 36   | Vdc       |
| Recommended External Fuse                  | Fast blow                               |     |           | 10.0 | A         |
| Start-up threshold                         | Rising input voltage                    | 7.7 | 8.3       | 9.0  | Vdc       |
| Undervoltage shutdown [9]                  | Falling input voltage                   | 6.9 | 7.3       | 7.7  | Vdc       |
| Overvoltage shutdown                       | Rising input voltage                    |     | None      |      | Vdc       |
| Reverse Polarity Protection [11]           | None, install external fuse             |     | None      |      | Vdc       |
| Internal Filter Type                       |   |     | LC        |      |           |
| Input Current                              |   |     |           |      |           |
| Full Load Conditions                       | Vin = nominal                           |     | 2.29      | 2.33 | A         |
| Low Line                                   | Vin = minimum, 3.3A load                |     | 6.14      | 6.24 | A         |
| Inrush Transient                           |   |     | 0.05      |      | A2-Sec.   |
| Output in Short Circuit                    |   |     | 50        | 100  | mA        |
| No Load Input Current                      | Iout = minimum, unit=ON                 |     | 65        | 85   | mA        |
| Shut-Down Mode Input Current (Off, UV, OT) |   |     | 1         | 2    | mA        |
| Reflected (back) ripple current [2]        | Measured at input with specified filter |     | 30        | 35   | mA, pk-pk |
| Reflected (back) ripple current            | Measured at input without filter        |     | 250       | 300  | mA, pk-pk |
| Pre-biased startup                         | External output voltage < Vset          |     | Monotonic |      |           |

| GENERAL and SAFETY                                   |  |      |       |  |                         |
|--|--|------|-------|--|-------------------------|
| Efficiency   | Vin=9V, full load  | 89.0 | 90.5  |  | %                       |
|  | Vin=24V, full load   | 89.5 | 91.0  |  | %                       |
| Isolation  |  |      |       |  |                         |
| Isolation Voltage, Input to Output                   |  | 2250 |       |  | Vdc                     |
| Insulation Safety Rating                             |  |      | Basic |  |                         |
| Isolation Resistance                                 |  |      | 100   |  | MΩ                      |
| Isolation Capacitance                                |  |      | 1000  |  | pF                      |
| Safety (Designed to meet the following requirements) | UL-60950-1, IEC/EN60950-1, 2nd Edition   |      | Yes   |  |                         |
| Calculated MTBF [3]                                  | Per Telcordia SR-332, Issue 3, Case 3, Ground Benign controlled, Tambient=40°C |      | 10.9  |  | Hours x 10 <sup>6</sup> |

| DYNAMIC CHARACTERISTICS     |  |     |      |      |      |
|-----------------------------|--|-----|------|------|------|
| Fixed Switching Frequency   |  | 225 | 275  | 325  | kHz  |
| Power Up Startup Time       | Power On to Vout regulated                               |     |      | 30   | mS   |
| On/Off Startup Time         | Remote ON to Vout regulated                              |     |      | 30   | mS   |
| Dynamic Load Response       | 50-75-50% load step, settling time to within ±1% of Vout |     | 250  | 300  | µSec |
| Dynamic Load Peak Deviation | Same as above,   |     | ±350 | ±400 | mV   |

| FEATURES and OPTIONS      |                                      |      |   |     |     |
|---------------------------|--------------------------------------|------|---|-----|-----|
| Remote On/Off Control [4] |                                      |      |   |     |     |
| "N" suffix                |                                      |      |   |     |     |
| Negative Logic, ON state  | ON=Pin grounded or external voltage  | -0.1 |   | 0.8 | Vdc |
| Negative Logic, OFF state | OFF=Pin open or external voltage     | 2.5  |   | 15  | Vdc |
| Control Current           | Open collector/drain, sourcing       |      | 1 | 2   | mA  |
| "P" suffix                |                                      |      |   |     |     |
| Positive Logic, ON state  | ON=Pin open or external voltage      | 10   |   | 15  | Vdc |
| Positive Logic, OFF state | OFF=Pin grounded or external voltage | 0    |   | 0.7 | Vdc |
| Control Current           | Open collector/drain, sinking        |      | 1 | 2   | mA  |

## FUNCTIONAL SPECIFICATIONS, UWS-15/3-Q12 (CONT.)

| OUTPUT   | Conditions [1]                                       | Minimum | Typical/Nominal    | Maximum | Units         |
|--|--|---------|--------------------|---------|---------------|
| <b>Total Output Power</b>                          | See Derating   | 0       | 49.5               | 50.00   | W             |
| <b>Voltage</b>                                     |  |         |                    |         |               |
| Nominal Output Voltage                             | No trim  | 14.85   | 15                 | 15.15   | Vdc           |
| Setting Accuracy                                   | At 50% load  |         | ±1                 |         | % of Vnom.    |
| Output Voltage Range [6]                           | User-adjustable                                      | -20     |                    | 10      | % of Vnom.    |
| Overvoltage Protection [8]                         | Via magnetic feedback                                |         | 18.5               |         | Vdc           |
| <b>Current</b>                                     |  |         |                    |         |               |
| Output Current Range                               | Vin=9V-36V   | 0       |                    | 3.3     | A             |
| Minimum Load                                       |  |         | No minimum load    |         |               |
| Current Limit Inception                            | 98% of Vnom., after warmup                           | 3.80    | 5.50               | 6.30    | A             |
| <b>Short Circuit</b>                               |  |         |                    |         |               |
| Short Circuit Current                              | Hiccup technique, autorecovery within ±1.25% of Vout |         | 0.6                |         | A             |
| Short Circuit Duration (remove short for recovery) | Output shorted to ground, no damage                  |         | Continuous         |         |               |
| Short circuit protection method                    | Current limiting                                     |         |                    |         |               |
| <b>Regulation [5]</b>                              |  |         |                    |         |               |
| Line Regulation                                    | Vin=min. to max., Vout=nom., full load               |         |                    | ±0.125  | %             |
| Load Regulation                                    | Iout=min. to max., Vin=24V                           |         |                    | ±0.125  | %             |
| Ripple and Noise [7][10]                           | with a 1uF    10uF output caps                       |         | 115                | 150     | mV pk-pk      |
| Temperature Coefficient                            | At all outputs                                       |         | ±0.02              |         | % of Vnom./°C |
| Remote Sense Compensation                          | Sense connected at load                              |         | 10                 |         | % of Vout     |
| Maximum Capacitive Load                            | Constant resistance mode, low ESR                    | 0       | 2200               |         | µF            |
| <b>MECHANICAL</b>                                  |  |         |                    |         |               |
| Outline Dimensions                                 |  |         | 1.30 x 0.90 x 0.36 |         | Inches        |
| (Please refer to outline drawing)                  | L x W x H  |         | 33.0 x 22.9 x 9.1  |         | mm            |
| Weight   |  |         | 0.48               |         | Ounces        |
|  |  |         | 13.6               |         | Grams         |
| Through Hole Pin Diameter                          |  |         | 0.060 & 0.040      |         | Inches        |
|  |  |         | 1.52 & 1.02        |         | mm            |
| Through Hole Pin Material                          |  |         | Copper alloy       |         |               |
| TH Pin Plating Metal and Thickness                 | Nickel subplate                                      |         | 50                 |         | µ-inches      |
|  | Gold overplate                                       |         | 5                  |         | µ-inches      |
| EMI/RFI Shielding                                  |  |         | None               |         |               |
| <b>ENVIRONMENTAL</b>                               |  |         |                    |         |               |
| Operating Ambient Temperature Range                | No derating, full power, natural convection          | -40     |                    | 85      | °C            |
| Operating Case Temperature Range                   | No derating, full power, natural convection          | -40     |                    | 105     | °C            |
| Storage Temperature                                | Vin = Zero (no power)                                | -55     |                    | 125     | °C            |
| Thermal Protection/Shutdown                        | Measured in center                                   | 115     | 125                | 130     | °C            |
| Electromagnetic Interference                       | External filter is required                          |         |                    |         |               |
| Conducted, EN55022/CISPR22                         |  |         | B                  |         | Class         |
| RoHS rating  |  |         | RoHS-6             |         |               |

**TYPICAL PERFORMANCE DATA, UWS-15/3-Q12**

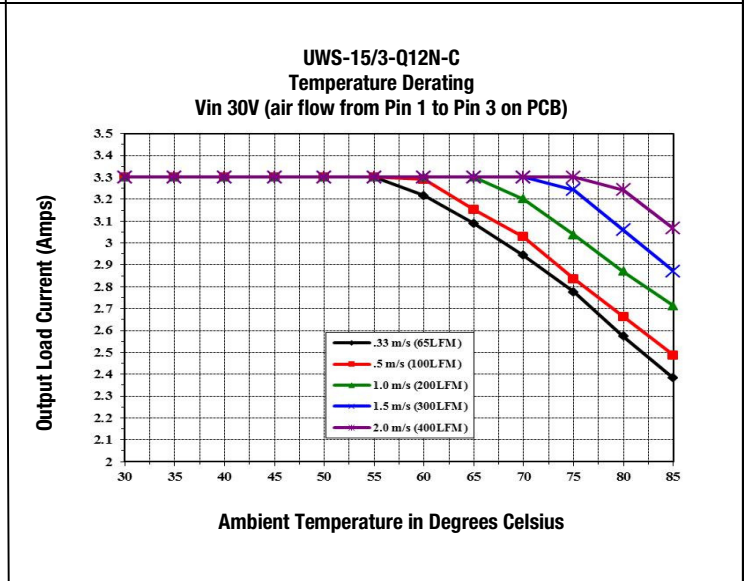
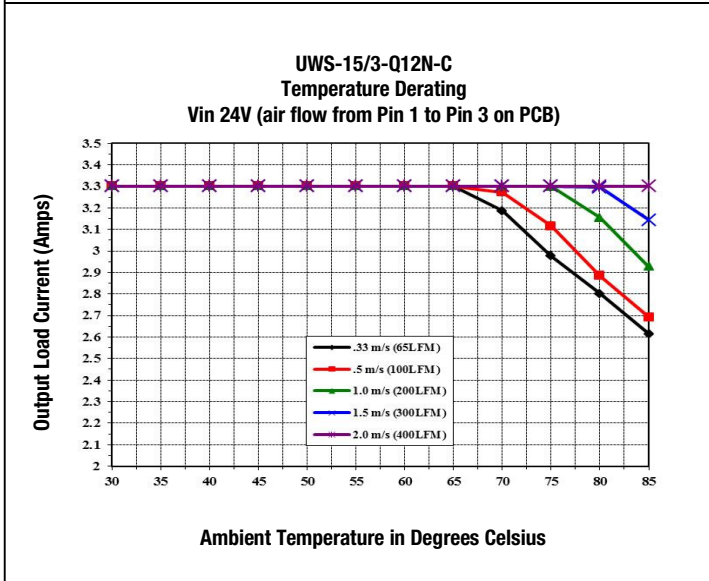
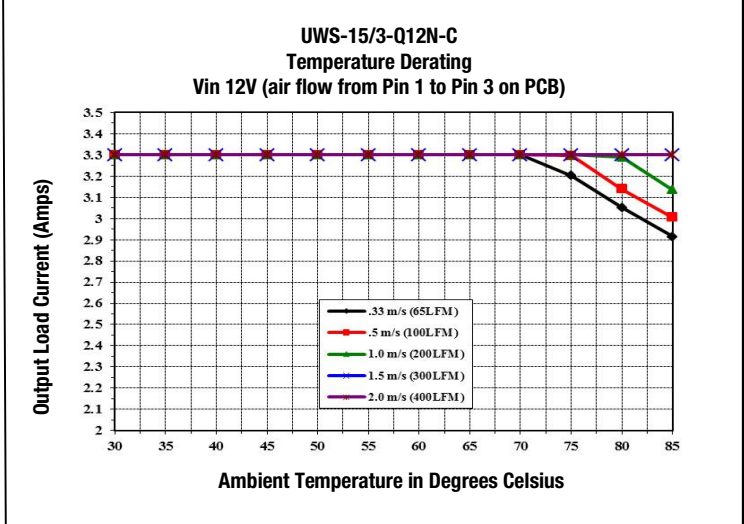
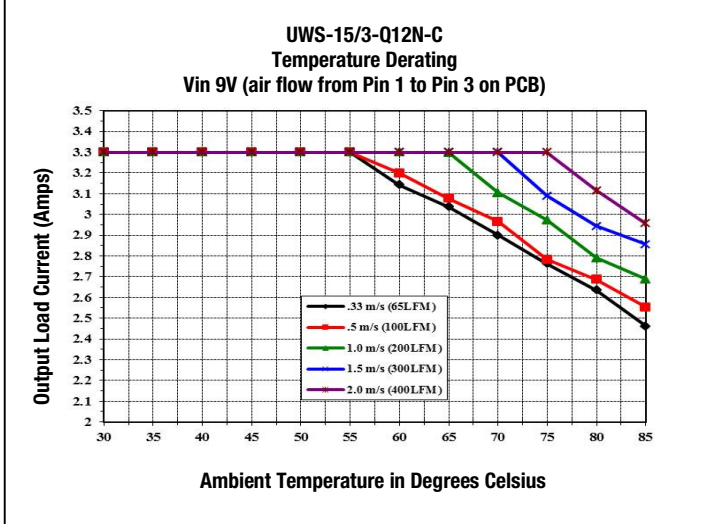
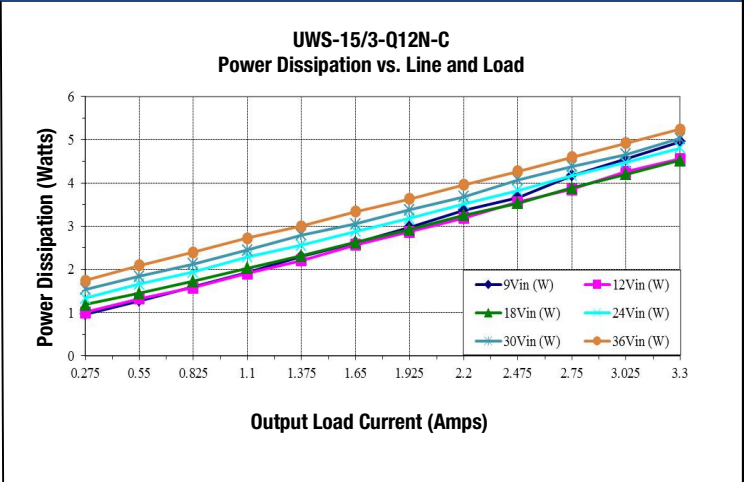
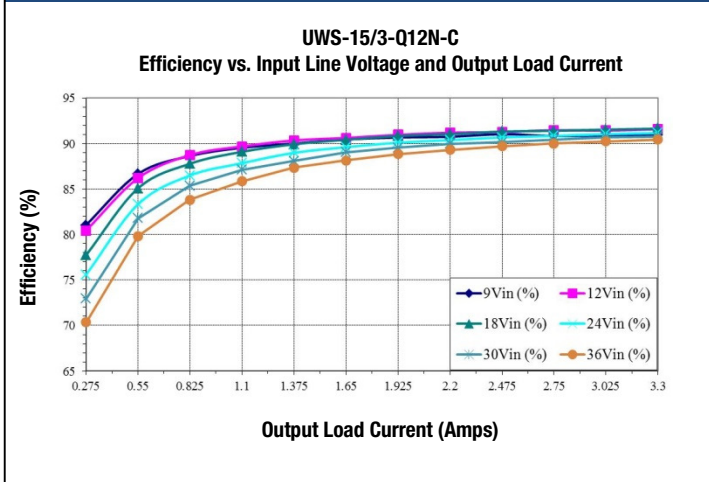

**TYPICAL PERFORMANCE DATA, UWS-15/3-Q12**

Output Ripple and Noise (Vin=24V, Vout=nom., Iout=no load, Cload=1μF ceramic II 10μF tantalum, Ta=+25°C., ScopeBW=20MHz)

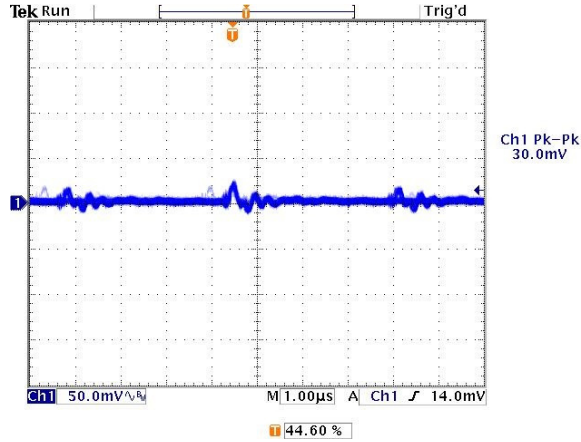

Output Ripple and Noise (Vin=24V, Vout=nom., Iout=3.3A, Cload=1μF ceramic II 10μF tantalum, Ta=+25°C., ScopeBW=20MHz)

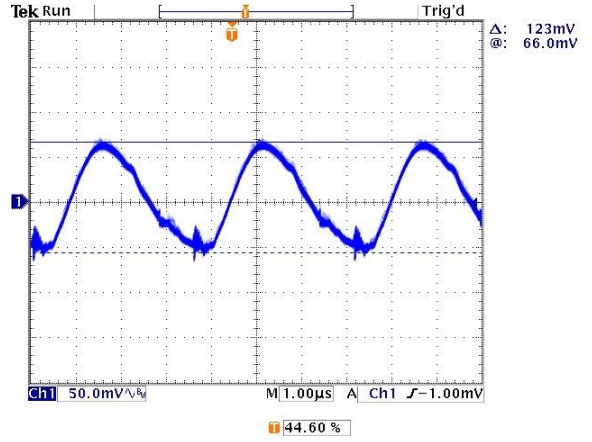

On/Off Enable Delay (Negative logic, Vin=24V, Vout=nom., Iout=no load, Cload=0 μF, Ta=+25°C., ScopeBW=20MHz) Trace 1=Enable, Trace 2=Vout

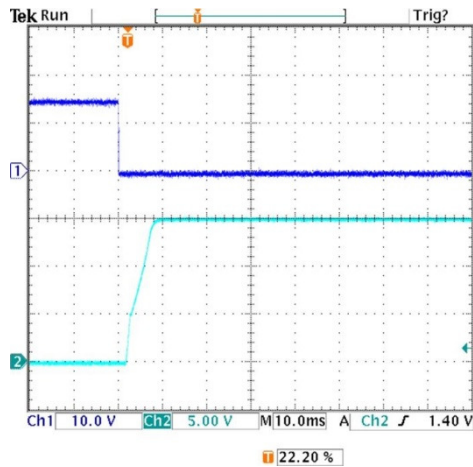

On/Off Enable Delay (Negative logic, Vin=24V, Vout=nom., Iout=3.3A, Cload=0 μF, Ta=+25°C., ScopeBW=20MHz) Trace 1=Enable, Trace 2=Vout

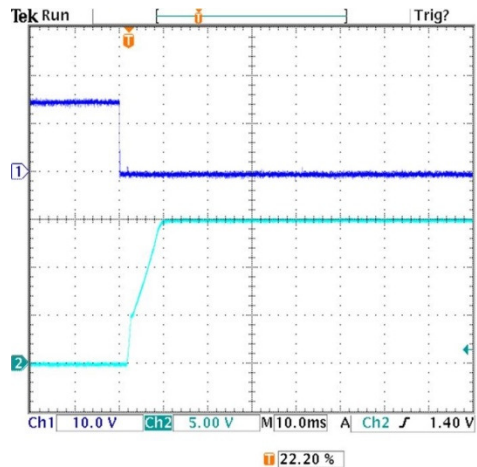

## TYPICAL PERFORMANCE DATA, UWS-15/3-Q12

Step Load Transient Response ( $V_{in}=24V$ ,  $V_{out}=nom.$ ,  $I_{out}=50-75-50\%$  of full load,  $C_{load}=1\mu F$  ceramic II  $10\mu F$  tantalum,  $T_a=+25^\circ C.$ , ScopeBW=20MHz)

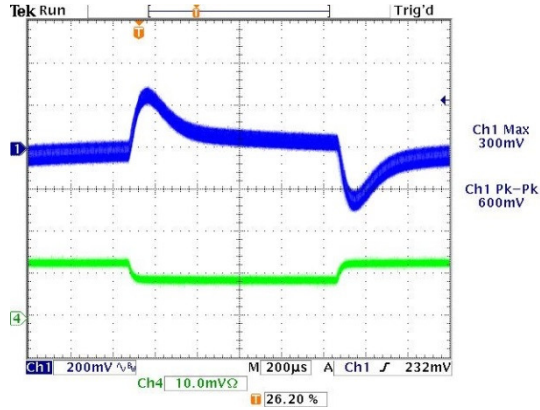

Step Load Transient Response ( $V_{in}=24V$ ,  $V_{out}=nom.$ ,  $I_{out}=50-75-50\%$  of full load,  $C_{load}=2000\mu F$ ,  $T_a=+25^\circ C.$ , ScopeBW=20MHz)

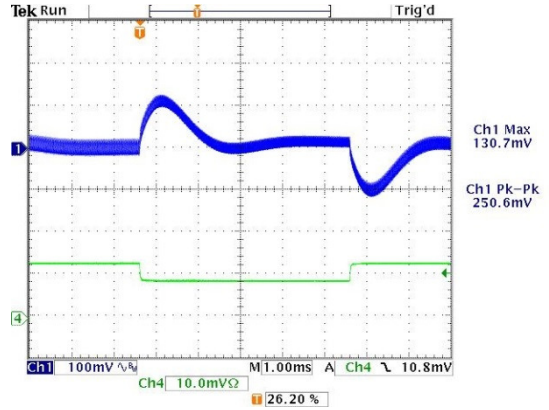

Power On Startup Delay ( $V_{in}=0$  to 24V,  $V_{out}=nom.$ ,  $I_{out}=no$  load,  $C_{load}=0\mu F$ ,  $T_a=+25^\circ C.$ , ScopeBW=20MHz) Trace 1= $V_{in}$ , Trace 2= $V_{out}$

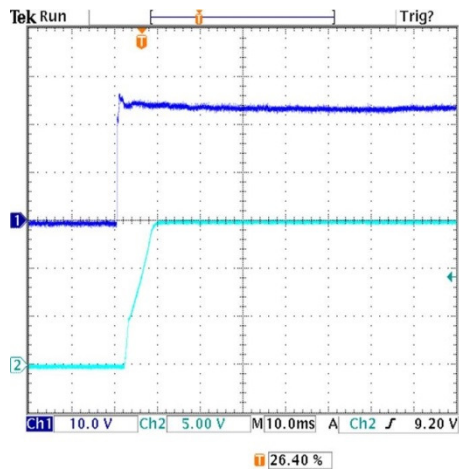

Power On Startup Delay ( $V_{in}=0$  to 24V,  $V_{out}=nom.$ ,  $I_{out}=3.3A$ ,  $C_{load}=0\mu F$ ,  $T_a=+25^\circ C.$ , ScopeBW=20MHz) Trace 1= $V_{in}$ , Trace 2= $V_{out}$

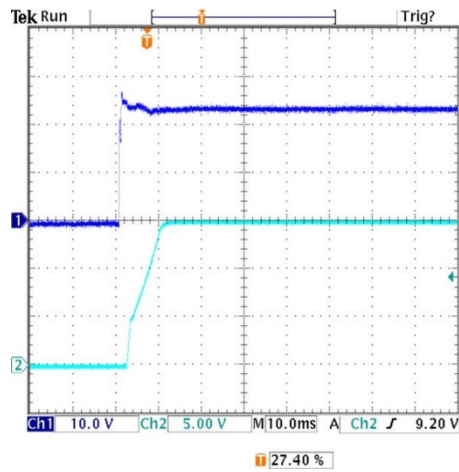

Pre-biased output voltage added connecting an external 2000uF to the output ( $V_{in}=24V$ ,  $I_{out}=0A$ ,  $+25^\circ C$ )

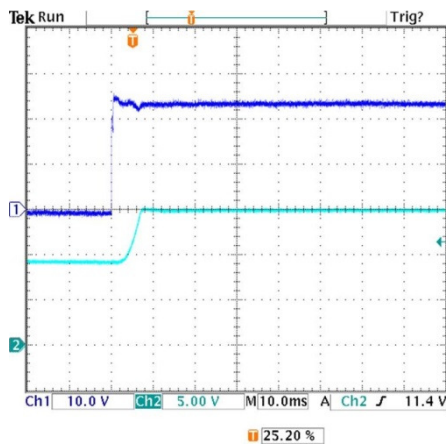

Pre-biased output voltage added connecting an external supply through a diode ( $V_{in}=24V$ ,  $I_{out}=0A$ ,  $+25^\circ C$ )

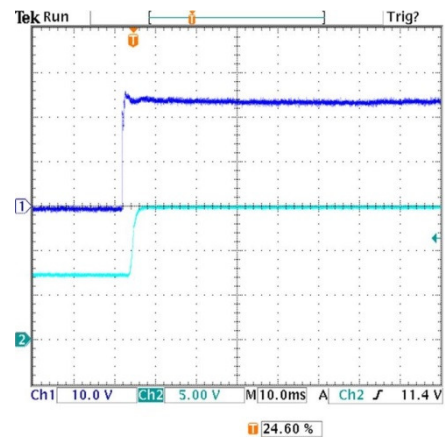

## FUNCTIONAL SPECIFICATIONS, UWS-24/2-Q12

| ABSOLUTE MAXIMUM RATINGS  | Conditions [1]                                      | Minimum | Typical/Nominal | Maximum | Units |
|---------------------------|---|---------|-----------------|---------|-------|
| Input Voltage, Continuous | Full temperature range                              | 0       |                 | 36      | Vdc   |
| Input Voltage, Transient  | Operating or non-operating, 100 mS max. duration    | 0       |                 | 50      | Vdc   |
| Isolation Voltage         | Input to output tested                              |         |                 | 2250    | Vdc   |
| Input Reverse Polarity    | None, install external fuse                         |         | None            |         | Vdc   |
| On/Off Remote Control     | Power on or off, referred to -Vin                   | 0       |                 | 15      | Vdc   |
| Output Power              |   | 0       |                 | 48.48   | W     |
| Output Current            | Current-limited, no damage, short-circuit protected | 0       |                 | 2.0     | A     |
| Storage Temperature Range | Vin = Zero (no power)                               | -55     |                 | 125     | °C    |

Absolute maximums are stress ratings. Exposure of devices to greater than any of these conditions may adversely affect long-term reliability. Proper operation under conditions other than those listed in the Performance/Functional Specifications Table is not implied or recommended.

| INPUT                                      |   |     |            |      |           |
|--|---|-----|------------|------|-----------|
| Operating voltage range                    |   | 9   | 24         | 36   | Vdc       |
| Recommended External Fuse                  | Fast blow                               |     |            | 10.0 | A         |
| Start-up threshold                         | Rising input voltage                    | 7.7 | 8.3        | 9.0  | Vdc       |
| Undervoltage shutdown [9]                  | Falling input voltage                   | 6.9 | 7.3        | 7.7  | Vdc       |
| Overvoltage shutdown                       | Rising input voltage                    |     | None       |      | Vdc       |
| Reverse Polarity Protection [11]           | None, install external fuse             |     | None       |      | Vdc       |
| Internal Filter Type                       |   |     | Capacitive |      |           |
| Input Current                              |   |     |            |      |           |
| Full Load Conditions                       | Vin = nominal                           |     | 2.20       | 2.27 | A         |
| Low Line                                   | Vin = minimum, 2A load                  |     | 5.86       | 6.05 | A         |
| Inrush Transient                           |   |     | 0.05       | 0.10 | A2-Sec.   |
| Output in Short Circuit                    |   |     | 50         | 100  | mA        |
| No Load Input Current                      | Iout = minimum, unit=ON                 |     | 130        | 150  | mA        |
| Shut-Down Mode Input Current (Off, UV, OT) |   |     | 1          | 2    | mA        |
| Reflected (back) ripple current [2]        | Measured at input with specified filter |     | 30         | 35   | mA, pk-pk |
| Reflected (back) ripple current            | Measured at input without filter        |     | 300        | 350  | mA, pk-pk |
| Pre-biased startup                         | External output voltage < Vset          |     | Monotonic  |      |           |

| GENERAL and SAFETY                                   |  |      |       |  |                         |
|--|--|------|-------|--|-------------------------|
| Efficiency   | Vin=9V, full load  | 89   | 91    |  | %                       |
|  | Vin=24V, full load   | 89   | 91    |  | %                       |
| Isolation  |  |      |       |  |                         |
| Isolation Voltage, Input to Output                   |  | 2250 |       |  | Vdc                     |
| Insulation Safety Rating                             |  |      | Basic |  |                         |
| Isolation Resistance                                 |  |      | 100   |  | MΩ                      |
| Isolation Capacitance                                |  |      | 1000  |  | pF                      |
| Safety (Designed to meet the following requirements) | UL-60950-1, IEC/EN60950-1, 2nd Edition   |      | Yes   |  |                         |
| Calculated MTBF [3]                                  | Per Telcordia SR-332, Issue 3, Case 3, Ground Benign controlled, Tambient=40°C |      | 11.7  |  | Hours x 10 <sup>6</sup> |

| DYNAMIC CHARACTERISTICS     |  |     |      |      |      |
|-----------------------------|--|-----|------|------|------|
| Fixed Switching Frequency   |  | 225 | 275  | 325  | kHz  |
| Power Up Startup Time       | Power On to Vout regulated                               |     |      | 30   | mS   |
| On/Off Startup Time         | Remote ON to Vout regulated                              |     |      | 30   | mS   |
| Dynamic Load Response       | 50-75-50% load step, settling time to within ±1% of Vout |     | 250  | 300  | µSec |
| Dynamic Load Peak Deviation | Same as above,   |     | ±350 | ±400 | mV   |

| FEATURES and OPTIONS      |                                      |      |   |     |     |
|---------------------------|--------------------------------------|------|---|-----|-----|
| Remote On/Off Control [4] |                                      |      |   |     |     |
| "N" suffix                |                                      |      |   |     |     |
| Negative Logic, ON state  | ON=Pin grounded or external voltage  | -0.1 |   | 0.8 | Vdc |
| Negative Logic, OFF state | OFF=Pin open or external voltage     | 2.5  |   | 15  | Vdc |
| Control Current           | Open collector/drain, sourcing       |      | 1 | 2   | mA  |
| "P" suffix                |                                      |      |   |     |     |
| Positive Logic, ON state  | ON=Pin open or external voltage      | 10   |   | 15  | Vdc |
| Positive Logic, OFF state | OFF=Pin grounded or external voltage | 0    |   | 0.7 | Vdc |
| Control Current           | Open collector/drain, sinking        |      | 1 | 2   | mA  |

## FUNCTIONAL SPECIFICATIONS, UWS-24/2-Q12 (CONT.)

| OUTPUT   | Conditions [1]                                       | Minimum | Typical/Nominal    | Maximum | Units         |
|--|--|---------|--------------------|---------|---------------|
| <b>Total Output Power</b>                          | See Derating   | 0       | 48                 | 48.48   | W             |
| <b>Voltage</b>                                     |  |         |                    |         |               |
| Nominal Output Voltage                             | No trim  | 23.76   | 24                 | 24.24   | Vdc           |
| Setting Accuracy                                   | At 50% load  |         | ±1                 |         | % of Vnom.    |
| Output Voltage Range [6]                           | User-adjustable                                      | -20     |                    | 10      | % of Vnom.    |
| Overvoltage Protection [8]                         | Via magnetic feedback                                |         | 29                 | 31      | Vdc           |
| <b>Current</b>                                     |  |         |                    |         |               |
| Output Current Range                               | Vin=9V-36V   | 0       | 2.0                | 2.0     | A             |
| Minimum Load                                       |  |         | No minimum load    |         |               |
| Current Limit Inception                            | 98% of Vnom., after warmup                           | 2.75    | 3.45               | 4.15    | A             |
| <b>Short Circuit</b>                               |  |         |                    |         |               |
| Short Circuit Current                              | Hiccup technique, autorecovery within ±1.25% of Vout |         | 0.6                |         | A             |
| Short Circuit Duration (remove short for recovery) | Output shorted to ground, no damage                  |         | Continuous         |         |               |
| Short circuit protection method                    | Current limiting                                     |         |                    |         |               |
| <b>Regulation [5]</b>                              |  |         |                    |         |               |
| Line Regulation                                    | Vin=min. to max., Vout=nom., full load               |         |                    | ±0.125  | %             |
| Load Regulation                                    | Iout=min. to max., Vin=24V                           |         |                    | ±0.125  | %             |
| Ripple and Noise [7][10]                           | with a 1µF    10µF output caps                       |         | 140                | 240     | mV pk-pk      |
| Temperature Coefficient                            | At all outputs                                       |         | ±0.02              |         | % of Vnom./°C |
| Remote Sense Compensation                          | Sense connected at load                              |         | 10                 |         | % of Vout     |
| Maximum Capacitive Load                            | Constant resistance mode, low ESR                    | 0       | 680                |         | µF            |
| <b>MECHANICAL</b>                                  |  |         |                    |         |               |
| Outline Dimensions                                 |  |         | 1.30 x 0.90 x 0.36 |         | Inches        |
| (Please refer to outline drawing)                  | L x W x H  |         | 33.0 x 22.9 x 9.1  |         | mm            |
| Weight   |  |         | 0.48               |         | Ounces        |
|  |  |         | 13.6               |         | Grams         |
| Through Hole Pin Diameter                          |  |         | 0.060 & 0.040      |         | Inches        |
|  |  |         | 1.52 & 1.02        |         | mm            |
| Through Hole Pin Material                          |  |         | Copper alloy       |         |               |
| TH Pin Plating Metal and Thickness                 | Nickel subplate                                      |         | 50                 |         | µ-inches      |
|  | Gold overplate                                       |         | 5                  |         | µ-inches      |
| EMI/RFI Shielding                                  |  |         | None               |         |               |
| <b>ENVIRONMENTAL</b>                               |  |         |                    |         |               |
| Operating Ambient Temperature Range                | No derating, full power, natural convection          | -40     |                    | 85      | °C            |
| Operating Case Temperature Range                   | No derating, full power, natural convection          | -40     |                    | 105     | °C            |
| Storage Temperature                                | Vin = Zero (no power)                                | -55     |                    | 125     | °C            |
| Thermal Protection/Shutdown                        | Measured in center                                   | 115     | 125                | 130     | °C            |
| Electromagnetic Interference                       | External filter is required                          |         |                    |         |               |
| Conducted, EN55022/CISPR22                         |  |         | B                  |         | Class         |
| RoHS rating  |  |         | RoHS-6             |         |               |



**TYPICAL PERFORMANCE DATA, UWS-24/2-Q12**

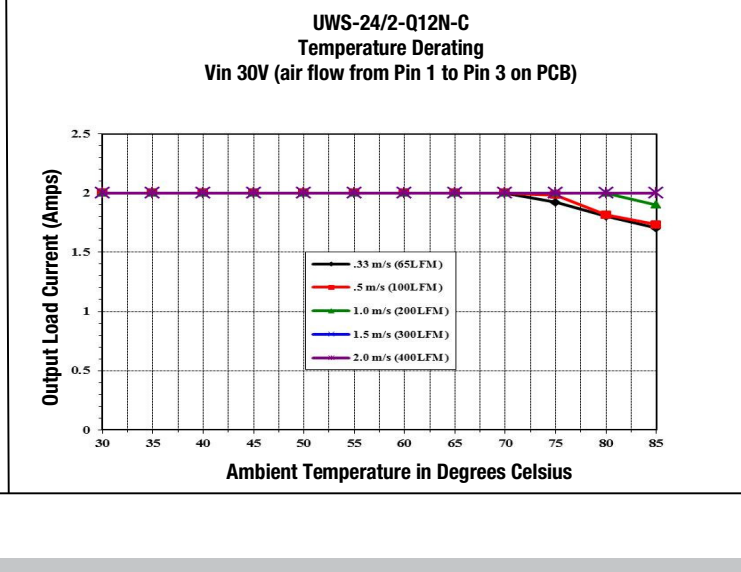
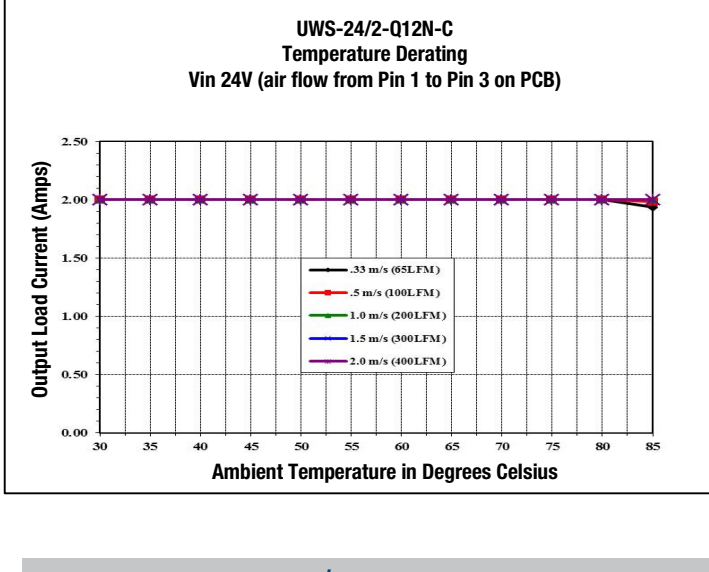
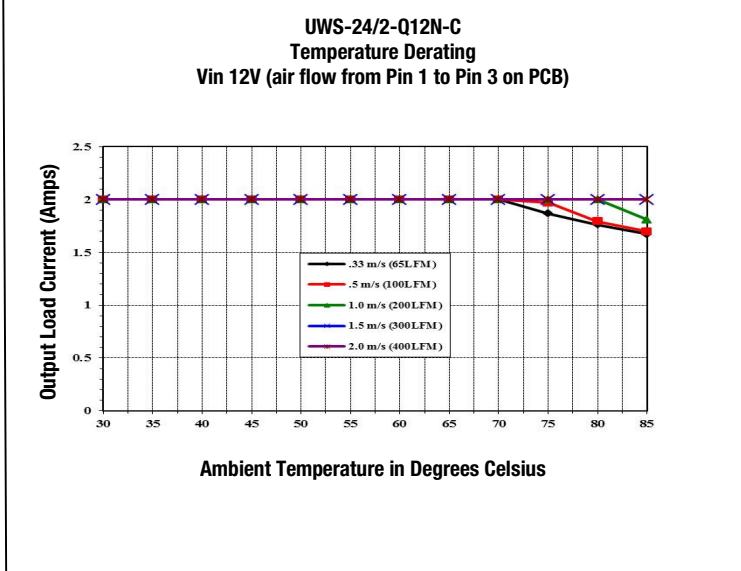
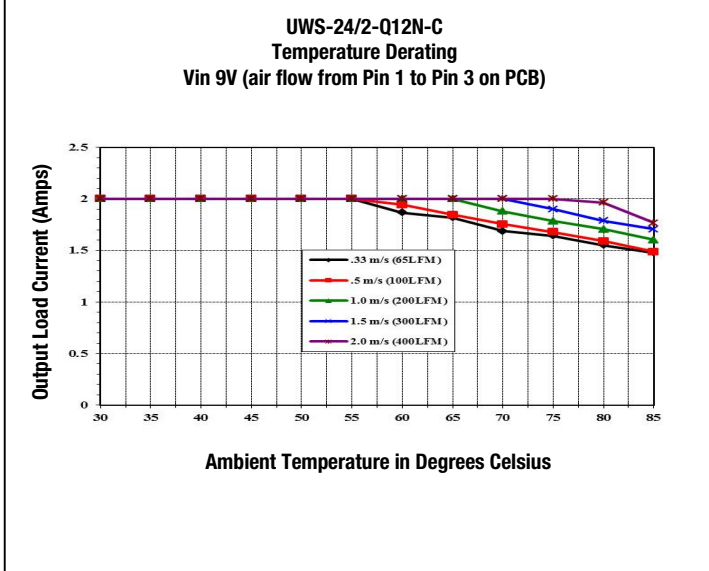
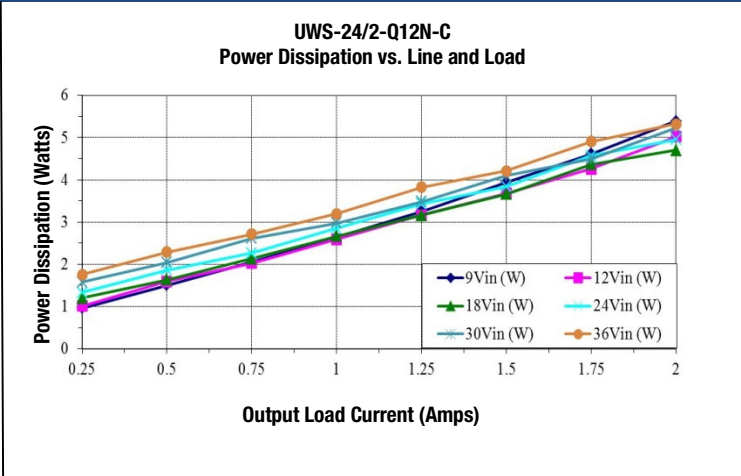
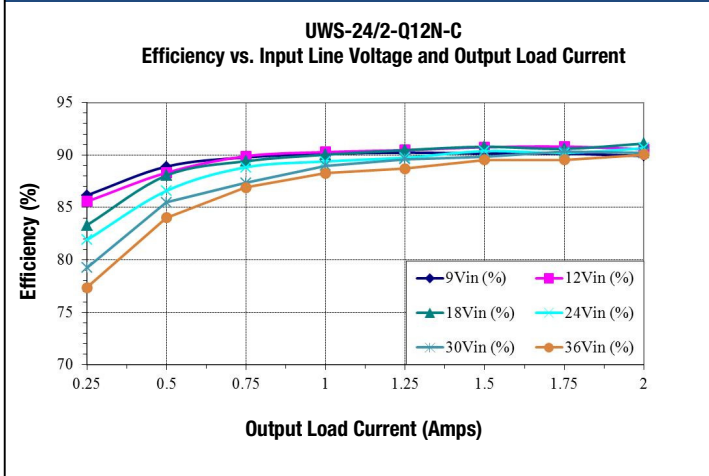

**TYPICAL PERFORMANCE DATA, UWS-24/2-Q12**

Output Ripple and Noise ( $V_{in}=24V$ ,  $V_{out}=nom.$ ,  $I_{out}=no\ load$ ,  $C_{load}=1\mu F$  ceramic II  $10\mu F$  tantalum,  $T_a=+25^{\circ}C.$ , ScopeBW=20MHz)

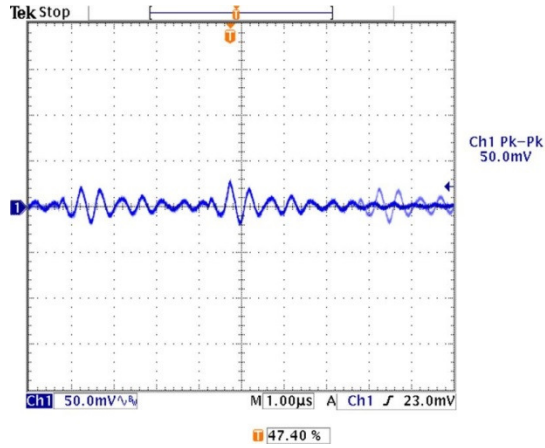

Output Ripple and Noise ( $V_{in}=24V$ ,  $V_{out}=nom.$ ,  $I_{out}=2A$ ,  $C_{load}=1\mu F$  ceramic II  $10\mu F$  tantalum,  $T_a=+25^{\circ}C.$ , ScopeBW=20MHz)

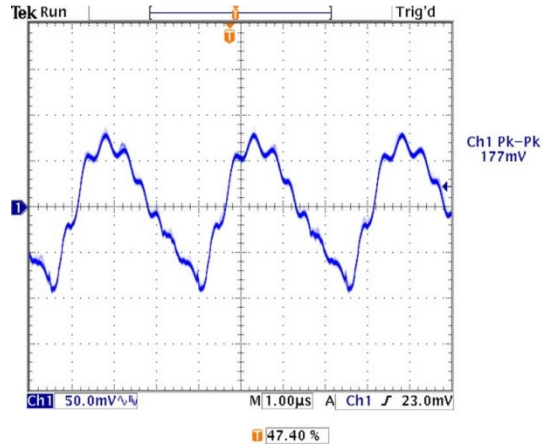

On/Off Enable Delay (Negative logic,  $V_{in}=24V$ ,  $V_{out}=nom.$ ,  $I_{out}=no\ load$ ,  $C_{load}=0\mu F$ ,  $T_a=+25^{\circ}C.$ , ScopeBW=20MHz) Trace 1=Enable, Trace 2=Vout

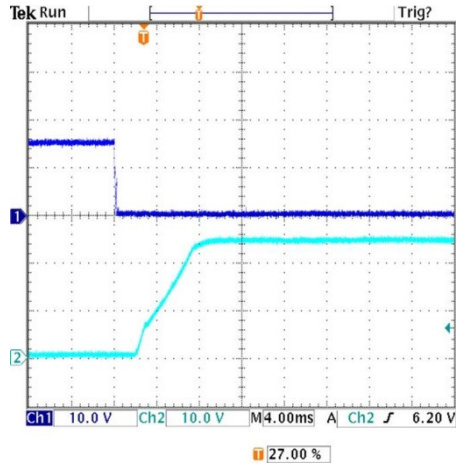

On/Off Enable Delay (Negative logic,  $V_{in}=24V$ ,  $V_{out}=nom.$ ,  $I_{out}=2A$ ,  $C_{load}=0\mu F$ ,  $T_a=+25^{\circ}C.$ , ScopeBW=20MHz) Trace 1=Enable, Trace 2=Vout

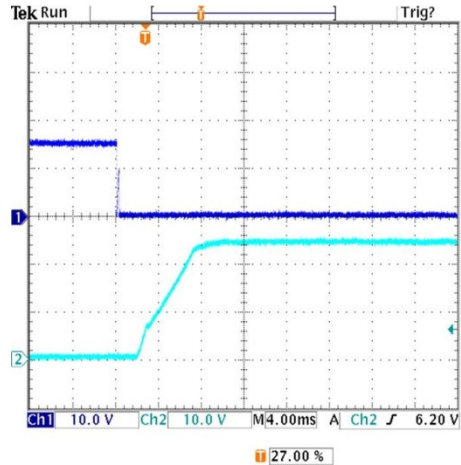

## TYPICAL PERFORMANCE DATA, UWS-24/2-Q12

Step Load Transient Response ( $V_{in}=24V$ ,  $V_{out}=nom.$ ,  $I_{out}=50-75-50\%$  of full load,  $C_{load}=1\mu F$  ceramic II  $10\mu F$  tantalum,  $T_a=+25^\circ C.$ , ScopeBW=20MHz)

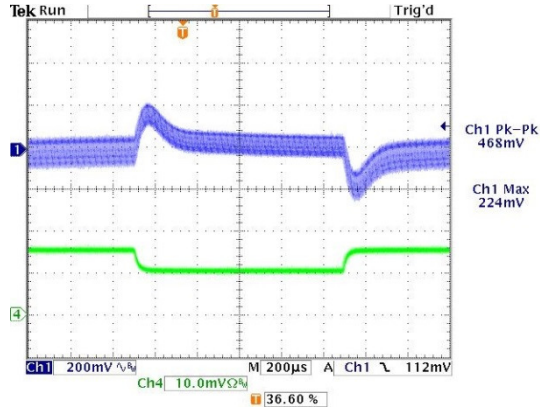

Step Load Transient Response ( $V_{in}=24V$ ,  $V_{out}=nom.$ ,  $I_{out}=50-75-50\%$  of full load,  $C_{load}=2000\mu F$ ,  $T_a=+25^\circ C.$ , ScopeBW=20MHz)

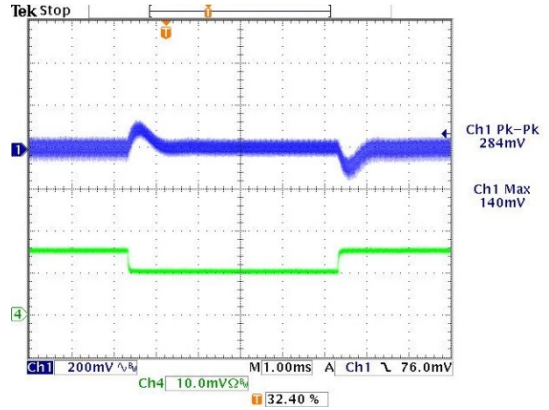

Power On Startup Delay ( $V_{in}=0$  to  $24V$ ,  $V_{out}=nom.$ ,  $I_{out}=no$  load,  $C_{load}=0\mu F$ ,  $T_a=+25^\circ C.$ , ScopeBW=20MHz) Trace 1= $V_{in}$ , Trace 2= $V_{out}$

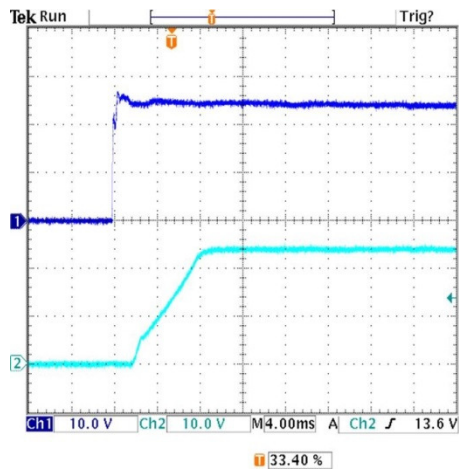

Power On Startup Delay ( $V_{in}=0$  to  $24V$ ,  $V_{out}=nom.$ ,  $I_{out}=2A$ ,  $C_{load}=0\mu F$ ,  $T_a=+25^\circ C.$ , ScopeBW=20MHz) Trace 1= $V_{in}$ , Trace 2= $V_{out}$

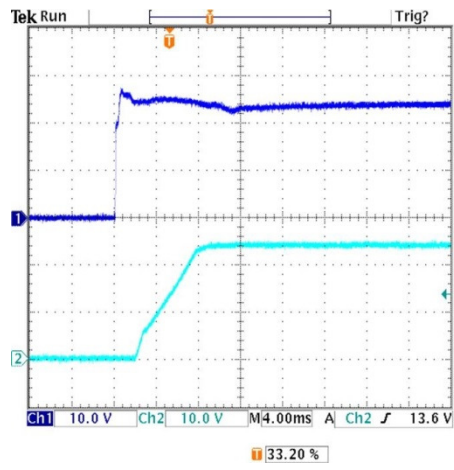

Pre-biased output voltage added connecting an external  $680\mu F$  to the output ( $V_{in}=24V$ ,  $I_{out}=0A$ ,  $+25^\circ C$ )

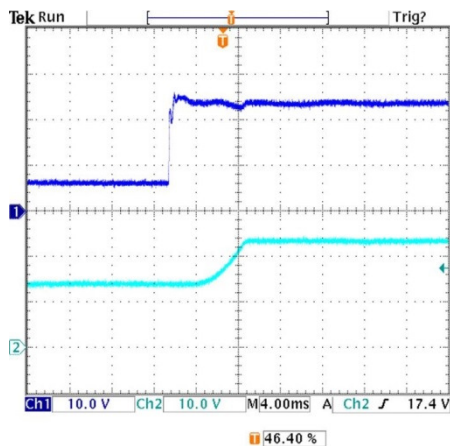

Pre-biased output voltage added connecting an external supply through a diode ( $V_{in}=24V$ ,  $I_{out}=0A$ ,  $+25^\circ C$ )

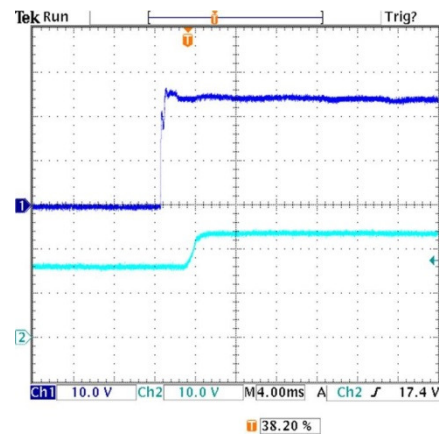

### Performance Specification Notes

1. All specifications are typical unless noted. Ambient temperature = +25°Celsius,  $V_{in}$  is nominal, output current is maximum rated nominal. External output capacitance is 1  $\mu\text{F}$  multilayer ceramic paralleled with 10  $\mu\text{F}$  electrolytic and a 220  $\mu\text{F}$  100V capacitor across the input pins. All caps are low ESR. These capacitors are necessary for our test equipment and may not be needed in your application. Testing must be kept short enough that the converter does not appreciably heat up during testing. For extended testing, use plenty of airflow. See Derating Curves for temperature performance. All models are stable and regulate within spec without external capacitance.
2. Input Ripple Current is tested and specified over a 5-20 MHz bandwidth and uses a special set of external filters only for the Ripple Current specifications. Input filtering is  $C_{in} = 33 \mu\text{F}$ ,  $C_{bus} = 220 \mu\text{F}$ ,  $L_{bus} = 12 \mu\text{H}$ . Use capacitor rated voltages which are twice the maximum expected voltage. Capacitors must accept high speed AC switching currents.
3. Mean Time Before Failure (MTBF) is calculated using the Telcordia (Belcore) SR-332 Issue, Case 3, ground benign controlled conditions. Operating temperature = +40°C, full output load, natural air convection.
4. The On/Off Control is normally driven from a switch or relay. An open collector/open drain transistor may be used in saturation and cut-off (pinch-off) modes. External logic may also be used if voltage levels are fully compliant to the specifications.
5. Regulation specifications describe the deviation as the input line voltage or output load current is varied from a nominal midpoint value to either extreme (50% load).
6. Do not exceed maximum power ratings or output overvoltage when adjusting output trim values.
7. At zero output current,  $V_{out}$  may contain components which slightly exceed the ripple and noise specifications.
8. Output overload protection is non-latching. When the output overload is removed, the output will automatically recover.
9. The converter will shut off if the input falls below the undervoltage threshold. It will not restart until the input exceeds the Input Start Up Voltage.
10. Output noise may be further reduced by installing an external filter. See the Application Notes. Use only as much output filtering as needed and no more. Larger caps (especially low-ESR ceramic types) may slow transient response or degrade dynamic performance. Thoroughly test your application with all components installed.
11. If reverse polarity is accidentally applied to the input, to ensure reverse input protection with full output load, always connect an external fast blow input fuse in series with the + $V_{in}$  input.

## MECHANICAL SPECIFICATIONS, THROUGH-HOLE MOUNT

Material:

- Ø .040 Pins: copper alloy
- Ø .060 Pins: copper alloy
- Finish: (all pins)
- Gold (5u"min) over nickel (50u" min)

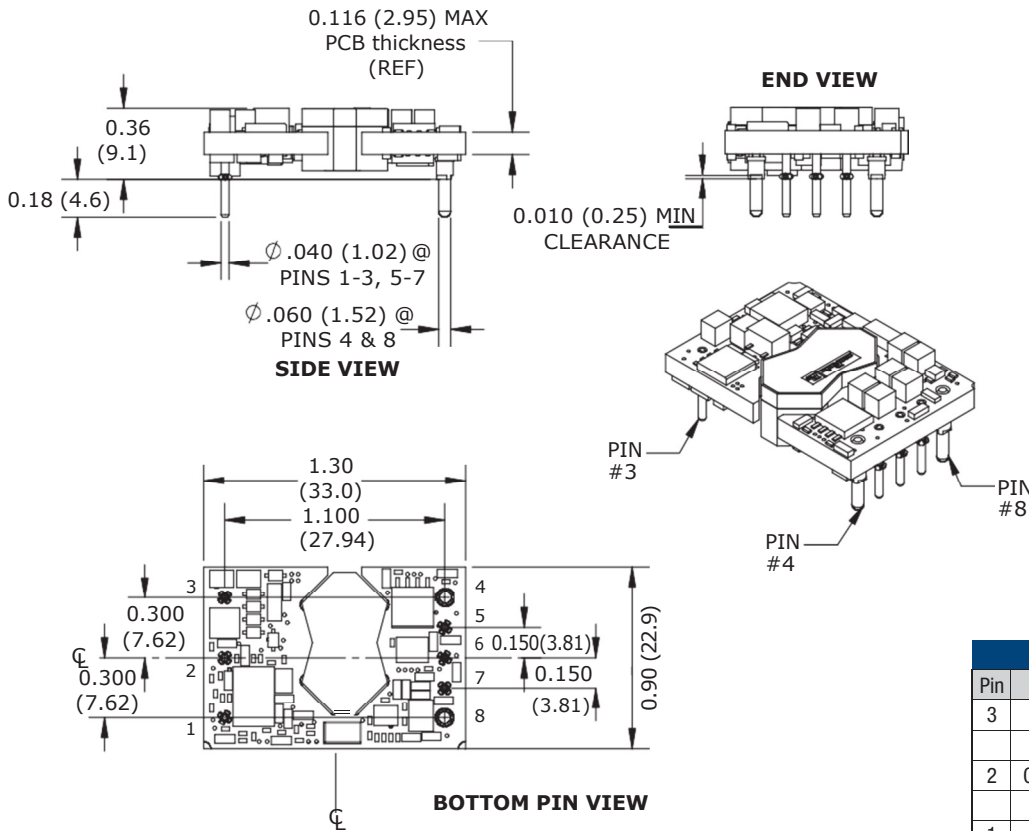

| INPUT/OUTPUT CONNECTIONS |                |     |             |
|--------------------------|----------------|-----|-------------|
| Pin                      | Function       | Pin | Function    |
| 3                        | -Vin           | 4   | -Vout       |
|                          |                | 5   | -Sense      |
| 2                        | On/Off Control | 6   | Output Trim |
|                          |                | 7   | +Sense      |
| 1                        | +Vin           | 8   | +Vout       |

Note that some competitive units may use different pin numbering or alternate outline views. However, all units are pinout compatible.

Standard pin length is shown. Please refer to the part number structure for alternate pin lengths.

It is recommended that no parts be placed beneath the converter.

### Recommended Footprint For Thru-hole Converter (View Through Converter)

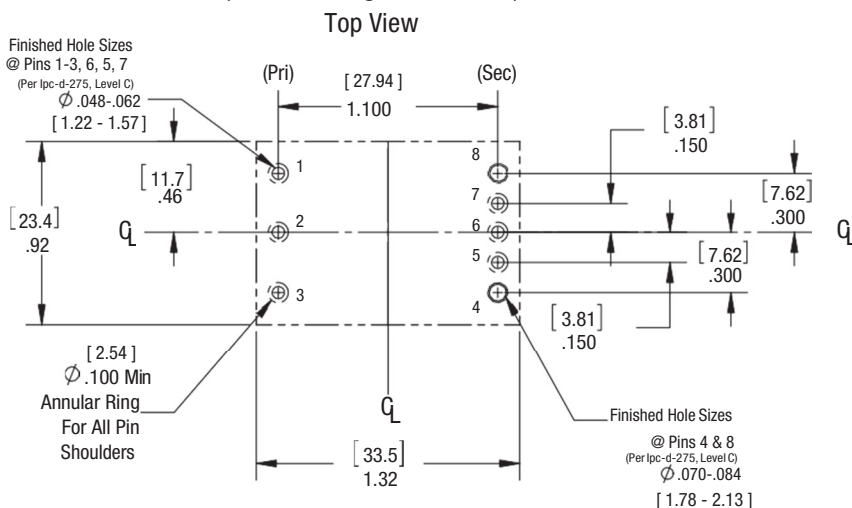

Dimensions are in inches (mm) shown for ref. only.

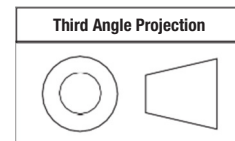

Tolerances (unless otherwise specified):  
 .XX ± 0.02 (0.5)  
 .XXX ± 0.010 (0.25)  
 Angles ± 1°

Components are shown for reference only and may vary between units.

**SHIPPING TRAYS AND BOXES, THROUGH-HOLE MOUNT**

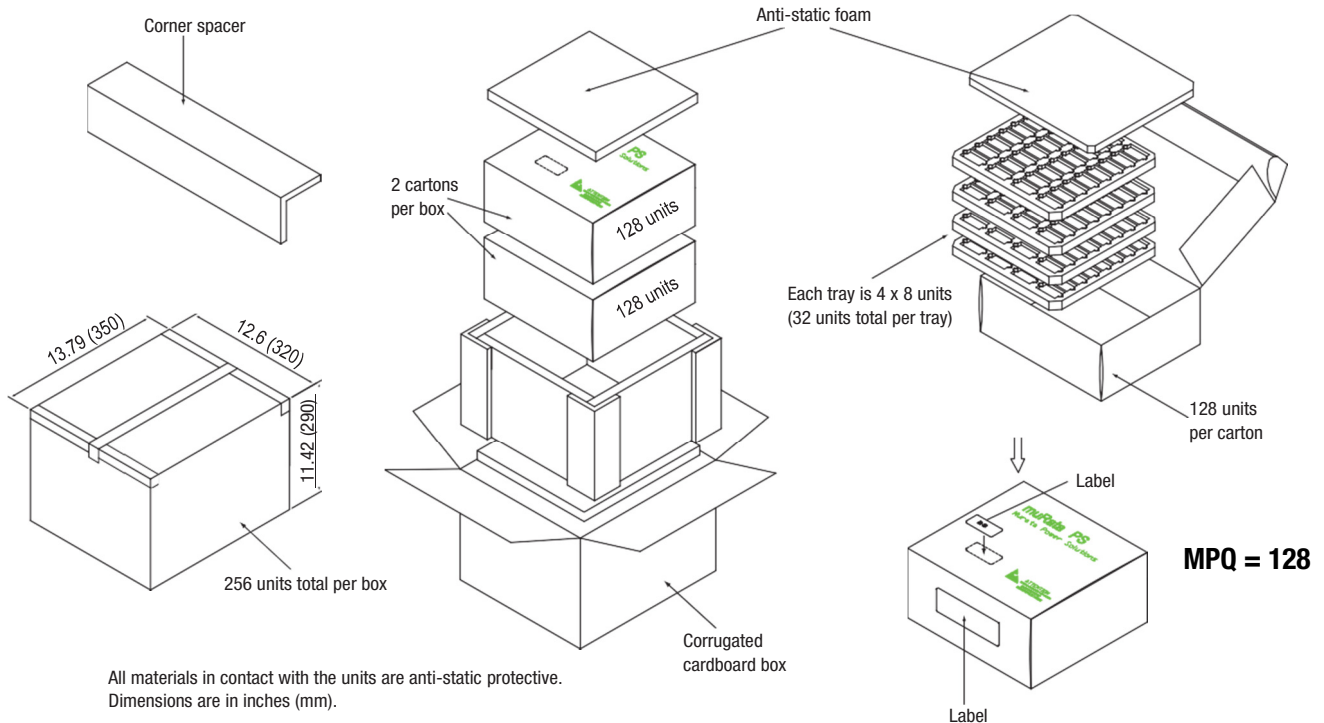

**SHIPPING TRAY DIMENSIONS**

Material: Low density, closed cell polyethylene anti-static foam

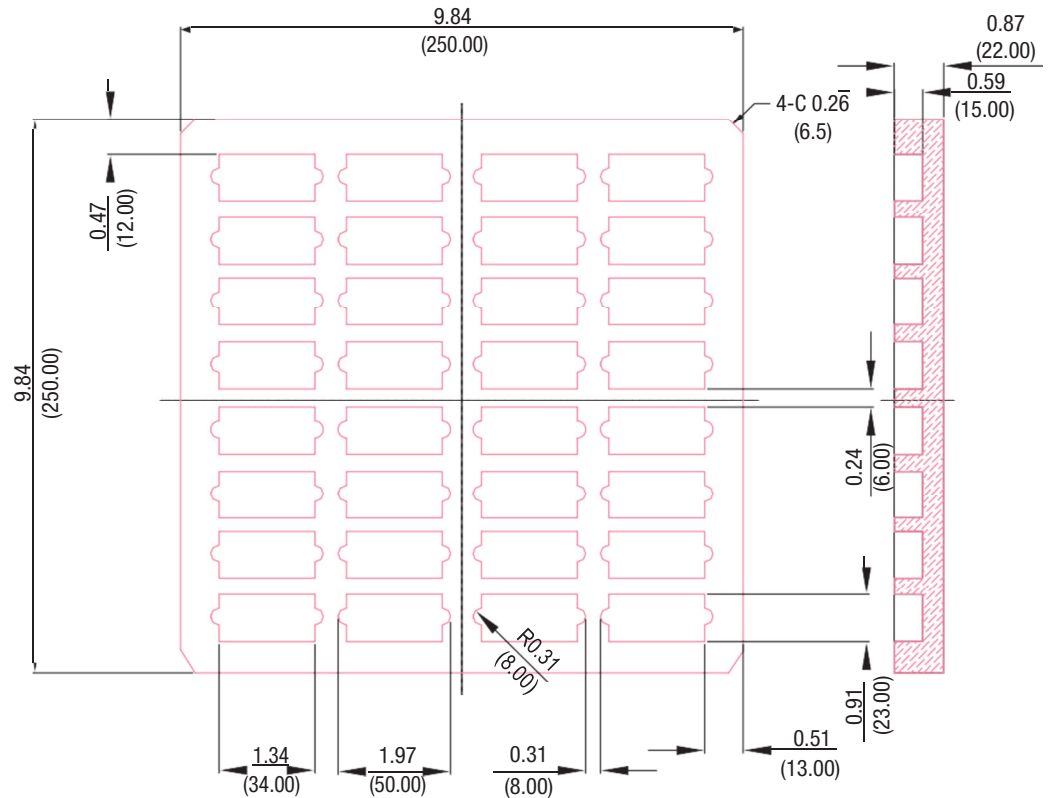

Dimensions are in millimeters.

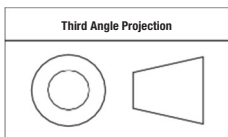

Tolerances (unless otherwise specified):

.XX ± 0.5

.XXX ± 0.25

Angles ± 2°

**TECHNICAL NOTES**

**Input Fusing**

Certain applications and/or safety agencies may require the installation of fuses at the inputs of power conversion components. Fuses should also be used if the possibility of sustained, non-current-limited, input-voltage polarity reversals exists. For Murata Power Solutions UWS series DC-DC converters, we recommend the use of a fast blow fuse, installed in the ungrounded input supply line with a typical value about twice the maximum input current, calculated at low line with the converter's minimum efficiency.

All relevant national and international safety standards and regulations must be observed by the installer. For system safety agency approvals, the converters must be installed in compliance with the requirements of the end use safety standard, i.e. IEC/EN/UL60950-1.

**Input Reverse-Polarity Protection**

If the input voltage polarity is accidentally reversed, an internal diode will become forward biased and likely draw excessive current from the power source. If this source is not current limited or the circuit appropriately fused, it could cause permanent damage to the converter.

**Input Under-Voltage Shutdown and Start-Up Threshold**

Under normal start-up conditions, devices will not begin to regulate properly until the ramping-up input voltage exceeds the Start-Up Threshold Voltage. Once operating, devices will not turn off until the input voltage drops below the Under-Voltage Shutdown limit. Subsequent re-start will not occur until the input is brought back up to the Start-Up Threshold. This built in hysteresis prevents any unstable on/off situations from occurring at a single input voltage.

**Start-Up Time**

The  $V_{IN}$  to  $V_{OUT}$  Start-Up Time is the time interval between the point at which the ramping input voltage crosses the Start-Up Threshold and the fully loaded output voltage enters and remains within its specified accuracy band. Actual measured times will vary with input source impedance, external input capacitance, and the slew rate and final value of the input voltage as it appears at the converter. The UWS Series implements a soft start circuit to limit the duty cycle of its PWM controller at power up, thereby limiting the input inrush current.

The On/Off Control to  $V_{OUT}$  start-up time assumes the converter has its nominal input voltage applied but is turned off via the On/Off Control pin. The specification defines the interval between the point at which the converter is turned on (released) and the fully loaded output voltage enters and remains within its specified accuracy band. Similar to the  $V_{IN}$  to  $V_{OUT}$  start-up, the On/Off Control to  $V_{OUT}$  start-up time is also governed by the internal soft start circuitry and external load capacitance. The difference in start up time from  $V_{IN}$  to  $V_{OUT}$  and from On/Off Control to  $V_{OUT}$  is therefore insignificant.

**Input Source Impedance**

The input of UWS converters must be driven from a low ac-impedance source. The DC-DC's performance and stability can be compromised by the use of highly inductive source impedances. The input circuit shown in Figure 2 is a practical solution that can be used to minimize the effects of inductance in the input traces. For optimum performance, components should be mounted close to the DC-DC converter.

**Transient and Surge Protection**

The input range of the UWS Q12 modules cover EN50155 requirements for Brownout and Transient conditions with Nominal input voltage of 24Vdc.

| EN50155 Standard |   |  |                                      |
|------------------|---|--|--------------------------------------|
| Nominal Input    | Permanent input range<br>(0.7 - 1.25 $V_{in}$ ) | Brownout<br>100ms<br>(0.6 x $V_{in}$ ) | Transient<br>1s<br>(1.4 x $V_{in}$ ) |
| 24V              | 16.6 - 30V                                      | 14.4V                                  | 33.6V                                |

**I/O Filtering, Input Ripple Current, and Output Noise**

All models in the UWS Series are tested/specified for input reflected ripple current and output noise using the specified external input/output components/circuits and layout as shown in the following two figures. External input capacitors ( $C_{IN}$  in Figure 2) serve primarily as energy-storage elements, minimizing line voltage variations caused by transient IR drops in conductors from backplane to the DC-DC. Input caps should be selected for bulk capacitance (at appropriate frequencies), low ESR, and high rms-ripple-current ratings. The switching nature of DC-DC converters requires that dc voltage sources have low ac impedance as highly inductive source impedance can affect system stability. In Figure 2,  $C_{BUS}$  and  $L_{BUS}$  simulate a typical dc voltage bus. Your specific

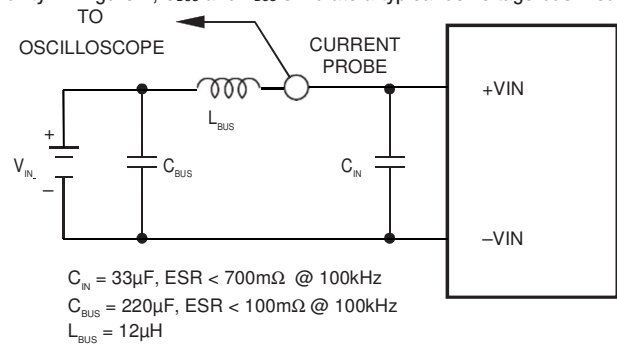
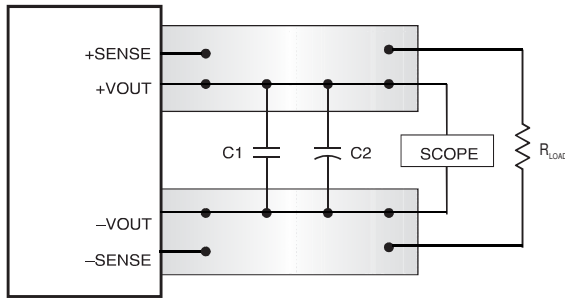

Figure 2. Measuring Input Ripple Current

system configuration may necessitate additional considerations.

In critical applications, output ripple/noise (also referred to as periodic and random deviations or PARD) may be reduced below specified limits using filtering techniques, the simplest of which is the installation of additional external output capacitors. They function as true filter elements and should be selected for bulk capacitance, low ESR and appropriate frequency response.

All external capacitors should have appropriate voltage ratings and be located as close to the converter as possible. Temperature variations for all relevant parameters should also be taken carefully into consideration. The most effective combination of external I/O capacitors will be a function of line voltage and source impedance, as well as particular load and layout conditions.



C1 = 1μF  
C2 = 10μF  
LOAD 2-3 INCHES (51-76mm) FROM MODULE

Figure 3. Measuring Output Ripple/Noise (PARD)

### Floating Outputs

Since these are isolated DC-DC converters, their outputs are “floating” with respect to their input. Designers will normally use the –Output as the ground/return of the load circuit. You can however, use the +Output as ground/return to effectively reverse the output polarity.

### Minimum Output Loading Requirements

UWS converters employ a synchronous-rectifier design topology and all models regulate within spec and are stable under no-load to full load conditions. Operation under no-load conditions however might slightly increase the output ripple and noise.

### Thermal Shutdown

The UWS converters are equipped with thermal-shutdown circuitry. If environmental conditions cause the temperature of the DC-DC converter to rise above the designed operating temperature, a precision temperature sensor will power down the unit. When the internal temperature decreases below the threshold of the temperature sensor, the unit will self start. See Performance/Functional Specifications.

### Output Over-Voltage Protection

The UWS output voltage is monitored for an over-voltage condition using a comparator. The signal is optically coupled to the primary side and if the output voltage rises to a level which could be damaging to the load, the sensing circuitry will power down the PWM controller causing the output voltage to decrease. Following a time-out period the PWM will restart, causing the output voltage to ramp to its appropriate value. If the fault condition persists, and the output voltage again climbs to excessive levels, the over-voltage circuitry will initiate another shutdown cycle. This on/off cycling is referred to as “hiccup” mode.

### Short Circuit Condition

When a converter is in current-limit mode, the output voltage will drop as the output current demand increases. If the output voltage drops too low, the magnetically coupled voltage used to develop primary side voltages will also drop, thereby shutting down the PWM controller. Following a time-out period, the PWM will restart causing the output voltage to begin ramping to their appropriate value. If the short-circuit condition persists, another shutdown cycle will be initiated. This on/off cycling is referred to as “hiccup” mode. The hiccup cycling reduces the average output current, thereby preventing internal temperatures from rising to excessive levels. The UWS Series is capable of enduring an indefinite short circuit output condition.

### Current Limiting

As soon as the output current increases to approximately 130% of its rated value, the DC-DC converter will go into a current-limiting mode. In this condition, the output voltage will decrease proportionately with increases in output current, thereby maintaining somewhat constant power dissipation. This is commonly referred to as power limiting. Current limit inception is defined as the point at which the full-power output voltage falls below the specified tolerance. See Performance/Functional Specifications. If the load current, being drawn from the converter, is significant enough, the unit will go into a short circuit condition as described below.

### Remote Sense

**Note:** The Sense and V<sub>OUT</sub> lines are internally connected through low-value resistors. Nevertheless, if the sense function is not used for remote regulation the user should connect the +Sense to +V<sub>OUT</sub> and –Sense to –V<sub>OUT</sub> at the DC-DC converter pins. UWS series converters employ a sense feature to provide point of use regulation, thereby overcoming moderate IR drops in PCB conductors or cabling. The remote sense lines carry very little current and therefore require minimal cross-sectional-area conductors. The sense lines, which are capacitively coupled to their respective output lines, are used by the feedback control-loop to regulate the output. As such, they are not low impedance points and must be treated with care in layouts and cabling. Sense lines on a PCB should be run adjacent to dc signals, preferably ground.

$$[V_{OUT(+)} - V_{OUT(-)}] - [Sense(+)-Sense(-)] \leq 10\%V_{OUT}$$

In cables and discrete wiring applications, twisted pair or other techniques should be used. Output over-voltage protection is monitored at the output voltage pin, not the Sense pin. Therefore, excessive voltage differences between V<sub>OUT</sub> and Sense in conjunction with trim adjustment of the output voltage can cause the over-voltage protection circuitry to activate (see Performance Specifications for over-voltage limits). Power derating is based on maximum output current and voltage at the converter’s output pins. Use of trim and sense functions can cause output voltages to increase, thereby increasing output power beyond the converter’s specified rating, or cause output voltages to climb into the output over-voltage region. Therefore, the designer must ensure:

$$(V_{OUT \text{ at pins}}) \times (I_{OUT}) \leq \text{rated output power}$$

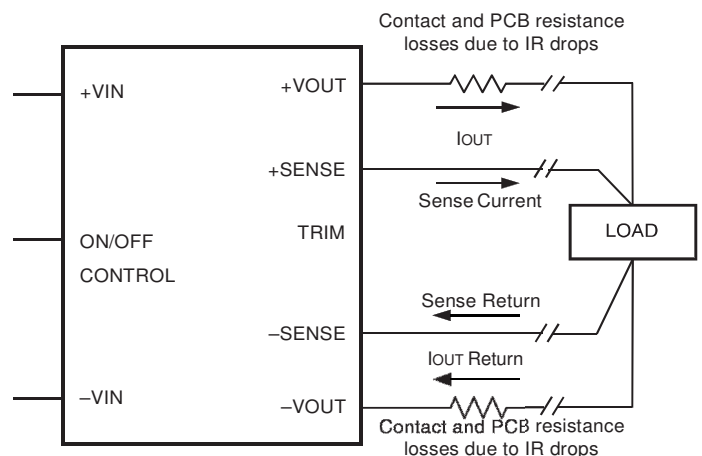

Figure 4. Remote Sense Circuit Configuration



**On/Off Control**

The input-side, remote On/Off Control function can be ordered to operate with either logic type:

**Positive** ("P" suffix) logic models are enabled when the On/Off pin is left open or is pulled high (see specifications) with respect to the -Input. Positive-logic devices are disabled when the on/off pin is pulled low with respect to the -Input.

**Negative** ("N" suffix) logic devices are off when the On/Off pin is left open or is pulled high (see specifications), and on when the pin is pulled low with respect to the -Input as per Figure 5. See specifications.

Dynamic control of the remote on/off function is best accomplished with a mechanical relay or an open-collector/open-drain drive circuit (optically isolated if appropriate). The drive circuit should be able to sink appropriate current (see Performance Specifications) when activated and withstand appropriate voltage when deactivated. Applying an external voltage to pin 2 when no input power is applied to the converter can cause permanent damage to the converter.

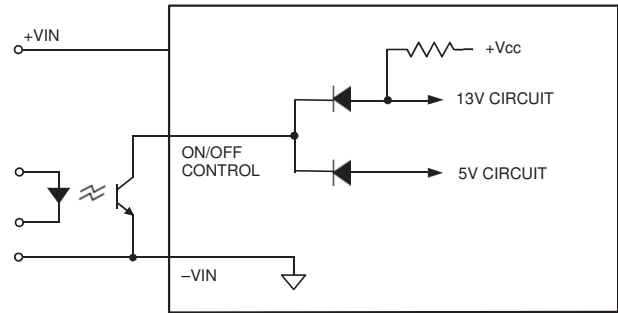

Figure 5. Driving the Negative Logic On/Off Control Pin (simplified circuit)

**OUTPUT VOLTAGE ADJUSTMENT**

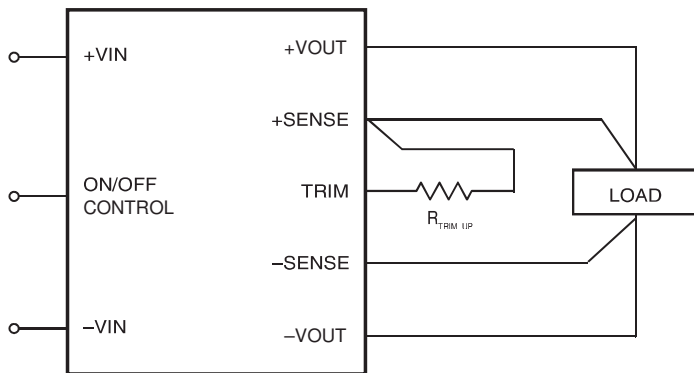

Figure 6. Trim Connections To Increase Output Voltages

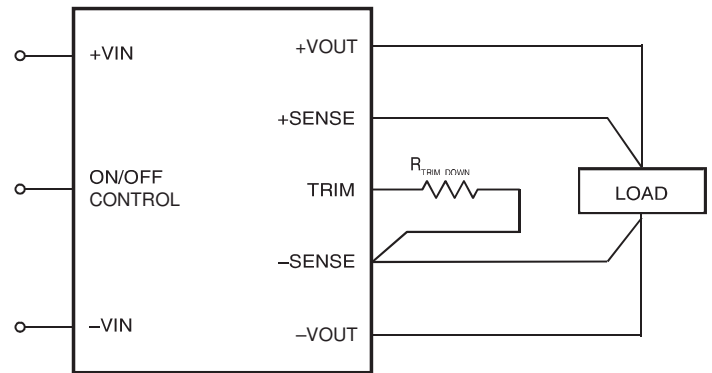

Figure 7. Trim Connections To Decrease Output Voltages

**Trim Equations**

|  |
|--|
| <p><b>Trim Down</b></p> $R_{T\_DOWN} (k\Omega) = \frac{511}{\Delta\%} - 10.22$ <p>Where <math>\Delta\% = \left( \left  \frac{V_{NOM} - V_{DES}}{V_{NOM}} \times 100 \right  \right)</math></p> |
| <p><b>Trim Up</b></p> $R_{T\_UP} (k\Omega) = \frac{5.11 \times V_{NOM} \times (100 + \Delta\%)}{1.225 \times \Delta\%} - \frac{511}{\Delta\%} - 10.22$   |
| <p><b>Note:</b> "Δ%" is always a positive value.<br/>             "VNOM" is the nominal, rated output voltage.<br/>             "VDES" is the desired, changed output voltage.</p>             |

### Vertical Wind Tunnel

Murata Power Solutions employs a computer controlled custom-designed closed loop vertical wind tunnel, infrared video camera system, and test instrumentation for accurate airflow and heat dissipation analysis of power products. The system includes a precision low flow-rate anemometer, variable speed fan, power supply input and load controls, temperature gauges, and adjustable heating element.

The IR camera monitors the thermal performance of the Unit Under Test (UUT) under static steady-state conditions. A special optical port is used which is transparent to infrared wavelengths.

Both through-hole and surface mount converters are soldered down to a 10" x 10" host carrier board for realistic heat absorption and spreading. Both longitudinal and transverse airflow studies are possible by rotation of this carrier board since there are often significant differences in the heat dissipation in the two airflow directions. The combination of adjustable airflow, adjustable ambient heat, and adjustable Input/Output currents and voltages mean that a very wide range of measurement conditions can be studied.

The collimator reduces the amount of turbulence adjacent to the UUT by minimizing airflow turbulence. Such turbulence influences the effective heat transfer characteristics and gives false readings. Excess turbulence removes more heat from some surfaces and less heat from others, possibly causing uneven overheating.

Both sides of the UUT are studied since there are different thermal gradients on each side. The adjustable heating element and fan, built-in temperature gauges, and no-contact IR camera mean that power supplies are tested in real-world conditions.

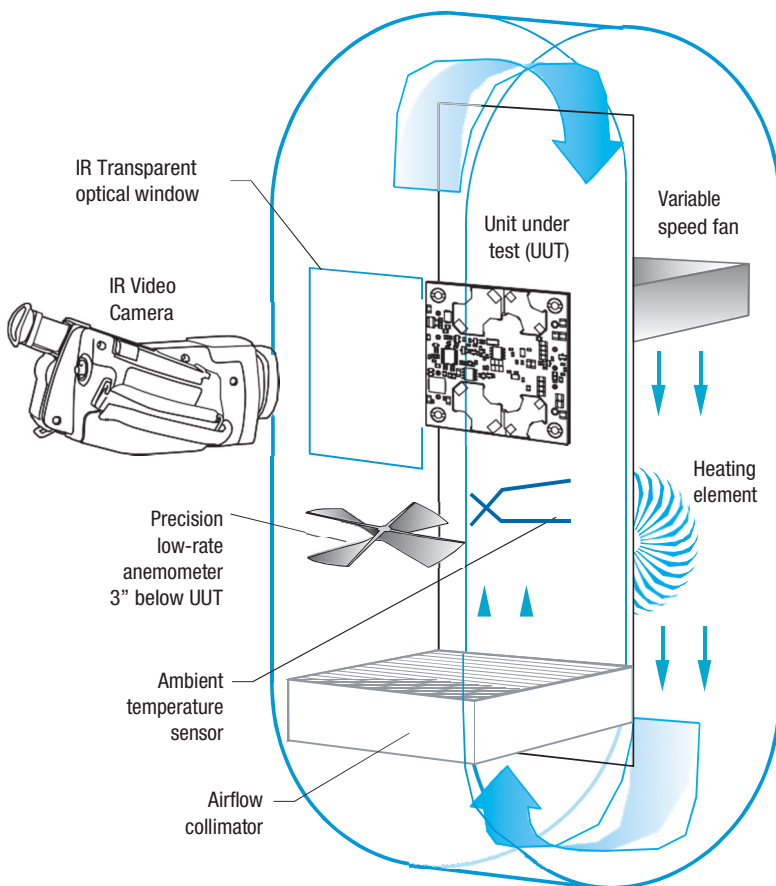

Figure 8. Vertical Wind Tunnel

### Through-Hole Soldering Guidelines

Murata Power Solutions recommends the TH soldering specifications below when installing these converters. These specifications vary depending on the solder type. Exceeding these specifications may cause damage to the product. Your production environment may differ; therefore please thoroughly review these guidelines with your process engineers.

| Wave Solder Operations for through-hole mounted products (THMT) |           |
|---|-----------|
| <b>For Sn/Ag/Cu based solders:</b>                              |           |
| Maximum Preheat Temperature                                     | 115° C    |
| Maximum Pot Temperature   | 270° C    |
| Maximum Solder Dwell Time                                       | 7 seconds |
| <b>For Sn/Pb based solders:</b>                                 |           |
| Maximum Preheat Temperature                                     | 105° C    |
| Maximum Pot Temperature   | 250° C    |
| Maximum Solder Dwell Time                                       | 6 seconds |

Murata Power Solutions, Inc.  
129 Flanders Road, Westborough, MA 01581 USA  
ISO 9001 and 14001 REGISTERED



This product is subject to the following [operating requirements](#) and the [Life and Safety Critical Application Sales Policy](#):  
Refer to: <http://www.murata-ps.com/requirements/>

Murata Power Solutions, Inc. makes no representation that the use of its products in the circuits described herein, or the use of other technical information contained herein, will not infringe upon existing or future patent rights. The descriptions contained herein do not imply the granting of licenses to make, use, or sell equipment constructed in accordance therewith. Specifications are subject to change without notice. © 2019 Murata Power Solutions, Inc.

# Mouser Electronics

Authorized Distributor

Click to View Pricing, Inventory, Delivery & Lifecycle Information:

## Murata:

[UWS-12/4.5-Q12N-C](#) [UWS-12/4.5-Q12P-C](#) [UWS-3.3/15-Q12N-C](#) [UWS-24/2-Q12N-C](#) [UWS-5/10-Q12P-C](#) [UWS-3.3/15-Q12P-C](#) [UWS-24/2-Q12P-C](#) [UWS-5/10-Q12N-C](#) [UWS-15/3-Q12P-C](#) [UWS-15/3-Q12N-C](#)

Компания «Океан Электроники» предлагает заключение долгосрочных отношений при поставках импортных электронных компонентов на взаимовыгодных условиях!

Наши преимущества:

- Поставка оригинальных импортных электронных компонентов напрямую с производств Америки, Европы и Азии, а так же с крупнейших складов мира;
- Широкая линейка поставок активных и пассивных импортных электронных компонентов (более 30 млн. наименований);
- Поставка сложных, дефицитных, либо снятых с производства позиций;
- Оперативные сроки поставки под заказ (от 5 рабочих дней);
- Экспресс доставка в любую точку России;
- Помощь Конструкторского Отдела и консультации квалифицированных инженеров;
- Техническая поддержка проекта, помощь в подборе аналогов, поставка прототипов;
- Поставка электронных компонентов под контролем ВП;
- Система менеджмента качества сертифицирована по Международному стандарту ISO 9001;
- При необходимости вся продукция военного и аэрокосмического назначения проходит испытания и сертификацию в лаборатории (по согласованию с заказчиком);
- Поставка специализированных компонентов военного и аэрокосмического уровня качества (Xilinx, Altera, Analog Devices, Intersil, Interpoint, Microsemi, Actel, Aeroflex, Peregrine, VPT, Syfer, Eurofarad, Texas Instruments, MS Kennedy, Miteq, Cobham, E2V, MA-COM, Hittite, Mini-Circuits, General Dynamics и др.);

Компания «Океан Электроники» является официальным дистрибьютором и эксклюзивным представителем в России одного из крупнейших производителей разъемов военного и аэрокосмического назначения «JONHON», а так же официальным дистрибьютором и эксклюзивным представителем в России производителя высокотехнологичных и надежных решений для передачи СВЧ сигналов «FORSTAR».



## JONHON

«JONHON» (основан в 1970 г.)

Разъемы специального, военного и аэрокосмического назначения:

(Применяются в военной, авиационной, аэрокосмической, морской, железнодорожной, горно- и нефтедобывающей отраслях промышленности)

«FORSTAR» (основан в 1998 г.)

ВЧ соединители, коаксиальные кабели, кабельные сборки и микроволновые компоненты:

(Применяются в телекоммуникациях гражданского и специального назначения, в средствах связи, РЛС, а так же военной, авиационной и аэрокосмической отраслях промышленности).



Телефон: 8 (812) 309-75-97 (многоканальный)

Факс: 8 (812) 320-03-32

Электронная почта: [ocean@oceanchips.ru](mailto:ocean@oceanchips.ru)

Web: <http://oceanchips.ru/>

Адрес: 198099, г. Санкт-Петербург, ул. Калинина, д. 2, корп. 4, лит. А