



## Features

- Fast tripping resettable circuit protection
- Surface mount packaging for automated assembly
- Small footprint size (1210)
- RoHS compliant\* and halogen free\*\*
- Agency recognition\*   

## Applications

- Game consoles
- PC motherboards
- USB port protection - USB 2.0, 3.0 & OTG
- HDMI 1.4 Source protection
- IEEE 1394 ports
- Mobile phones
- Digital cameras

# MF-USMF Series - PTC Resettable Fuses

## Electrical Characteristics

Model	V max. Volts	I max. Amps	I <sub>hold</sub>	I <sub>trip</sub>	Resistance		Max. Time To Trip		Tripped Power Dissipation
			Amperes at 23 °C		Ohms at 23 °C		Amperes at 23 °C	Seconds at 23 °C	Watts at 23 °C
			Hold	Trip	R <sub>Min.</sub>	R <sub>1Max.</sub>			Typ.
MF-USMF005	30	10	0.05	0.15	2.800	50.000	0.25	1.50	0.6
MF-USMF010	30	10	0.10	0.30	0.800	15.000	0.50	0.60	0.6
MF-USMF020	30	10	0.20	0.40	0.400	5.000	8.00	0.02	0.6
MF-USMF035	6	40	0.35	0.75	0.200	1.300	8.00	0.20	0.6
MF-USMF050	13.2	40	0.50	1.00	0.180	0.900	8.00	0.10	0.6
MF-USMF075	6	40	0.75	1.50	0.070	0.450	8.00	0.10	0.6
MF-USMF110	6	40	1.10	2.20	0.050	0.210	5.00	1.00	0.6
MF-USMF150	6	40	1.50	3.00	0.030	0.110	5.00	5.00	0.6
MF-USMF175X***	6	40	1.75	3.50	0.020	0.090	8.00	1.00	0.7

\*\*\* CSA approval pending.

## Environmental Characteristics

Operating Temperature.....	-40 °C to +85 °C
Maximum Device Surface Temperature in Tripped State .....	125 °C
Passive Aging .....	+85 °C, 1000 hours..... ±5 % typical resistance change
Humidity Aging .....	+85 °C, 85 % R.H. 1000 hours..... ±5 % typical resistance change
Thermal Shock .....	+85 °C to -40 °C, 20 times..... ±10 % typical resistance change
Solvent Resistance.....	MIL-STD-202, Method 215..... No change
Vibration .....	MIL-STD-883C, Method 2007.1, Condition A..... No change

## Test Procedures And Requirements For Model MF-USMF Series

Test	Test Conditions	Accept/Reject Criteria
Visual/Mech. ....	Verify dimensions and materials .....	Per MF physical description
Resistance .....	In still air @ 23 °C.....	R <sub>min</sub> ≤ R ≤ R <sub>1max</sub>
Time to Trip.....	At specified current, V <sub>max</sub> , 23 °C .....	T ≤ max. time to trip (seconds)
Hold Current.....	30 min. at I <sub>hold</sub> .....	No trip
Trip Cycle Life.....	V <sub>max</sub> , I <sub>max</sub> , 100 cycles.....	No arcing or burning
Trip Endurance .....	V <sub>max</sub> , 48 hours.....	No arcing or burning
Solderability.....	ANSI/J-STD-002.....	95 % min. coverage
UL File Number .....	E174545 <a href="http://www.ul.com/">http://www.ul.com/</a> Follow link to Certifications, then UL File No., enter E174545	
CSA File Number.....	CA110338 <a href="http://directories.csa-international.org/">http://directories.csa-international.org/</a> Under "Certification Record" and "File Number" enter 110338-0-000	
TÜV Certificate Number .....	R 02057213 <a href="http://www.tuvdotcom.com/">http://www.tuvdotcom.com/</a> Follow link to "other certificates", enter File No. 2057213	

\*RoHS Directive 2002/95/EC Jan 27 2003 including Annex.

\*\*To be considered halogen free, each homogenous material can have a maximum concentration of 900 ppm of either bromine or chlorine.

Specifications are subject to change without notice.

Customers should verify actual device performance in their specific applications.

# MF-USMF Series - PTC Resettable Fuses

**BOURNS®**

## Product Dimensions

Model	A		B		C		D
	Min.	Max.	Min.	Max.	Min.	Max.	Min.
MF-USMF005	$\frac{3.00}{(0.118)}$	$\frac{3.43}{(0.135)}$	$\frac{2.35}{(0.093)}$	$\frac{2.80}{(0.110)}$	$\frac{0.80}{(0.031)}$	$\frac{1.1}{(0.043)}$	$\frac{0.30}{(0.012)}$
MF-USMF010	$\frac{3.00}{(0.118)}$	$\frac{3.43}{(0.135)}$	$\frac{2.35}{(0.093)}$	$\frac{2.80}{(0.110)}$	$\frac{0.80}{(0.031)}$	$\frac{1.1}{(0.043)}$	$\frac{0.30}{(0.012)}$
MF-USMF020	$\frac{3.00}{(0.118)}$	$\frac{3.43}{(0.135)}$	$\frac{2.35}{(0.093)}$	$\frac{2.80}{(0.110)}$	$\frac{0.80}{(0.031)}$	$\frac{1.1}{(0.043)}$	$\frac{0.30}{(0.012)}$
MF-USMF035	$\frac{3.00}{(0.118)}$	$\frac{3.43}{(0.135)}$	$\frac{2.35}{(0.093)}$	$\frac{2.80}{(0.110)}$	$\frac{0.55}{(0.022)}$	$\frac{0.85}{(0.033)}$	$\frac{0.30}{(0.012)}$
MF-USMF050	$\frac{3.00}{(0.118)}$	$\frac{3.43}{(0.135)}$	$\frac{2.35}{(0.093)}$	$\frac{2.80}{(0.110)}$	$\frac{0.55}{(0.022)}$	$\frac{0.85}{(0.033)}$	$\frac{0.30}{(0.012)}$
MF-USMF075	$\frac{3.00}{(0.118)}$	$\frac{3.43}{(0.135)}$	$\frac{2.35}{(0.093)}$	$\frac{2.80}{(0.110)}$	$\frac{0.55}{(0.022)}$	$\frac{0.85}{(0.033)}$	$\frac{0.30}{(0.012)}$
MF-USMF110	$\frac{3.00}{(0.118)}$	$\frac{3.43}{(0.135)}$	$\frac{2.35}{(0.093)}$	$\frac{2.80}{(0.110)}$	$\frac{0.55}{(0.022)}$	$\frac{0.85}{(0.033)}$	$\frac{0.30}{(0.012)}$
MF-USMF150	$\frac{3.00}{(0.118)}$	$\frac{3.43}{(0.135)}$	$\frac{2.35}{(0.093)}$	$\frac{2.80}{(0.110)}$	$\frac{0.40}{(0.016)}$	$\frac{0.85}{(0.033)}$	$\frac{0.30}{(0.012)}$
MF-USMF175X	$\frac{3.00}{(0.118)}$	$\frac{3.43}{(0.135)}$	$\frac{2.35}{(0.093)}$	$\frac{2.80}{(0.110)}$	$\frac{0.40}{(0.016)}$	$\frac{0.85}{(0.033)}$	$\frac{0.30}{(0.012)}$

Packaging: 3000 pcs. per reel.

DIMENSIONS:  $\frac{\text{MM}}{\text{(INCHES)}}$

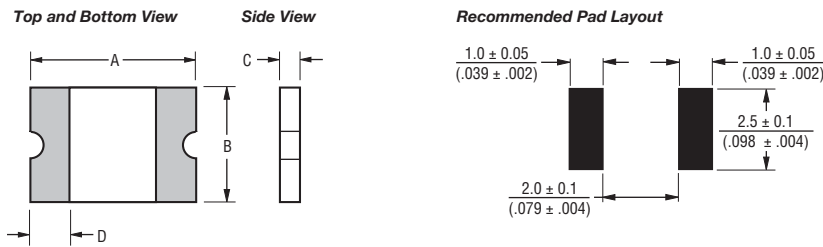

### Terminal material:

Electroless Ni under immersion Au

### Termination pad solderability:

Standard Au finish:  
Meets ANSI/J-STD-002 Category 2.

### Recommended Storage:

40 °C max./70 % RH max.

## Solder Reflow Recommendations

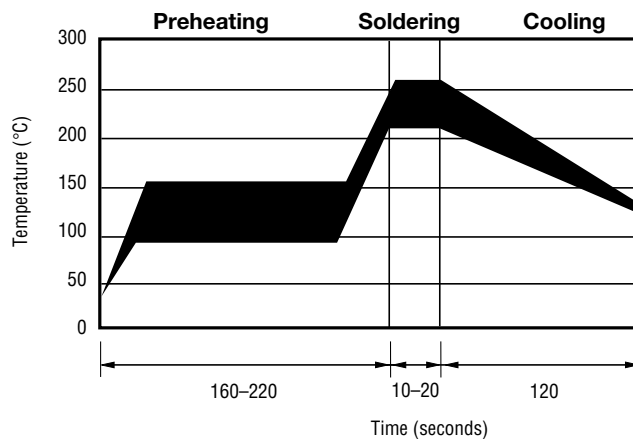

### Notes:

- MF-USMF models cannot be wave soldered.
- If reflow temperatures exceed the recommended profile, devices may not meet the performance requirements.
- Compatible with Pb and Pb-free solder reflow profiles.
- Excess solder may cause a short circuit, especially during hand soldering. Please refer to the Multifuse® Polymer PTC Soldering Recommendation guidelines.

Specifications are subject to change without notice.  
Customers should verify actual device performance in their specific applications.

# MF-USMF Series - PTC Resettable Fuses

# BOURNS®

## Thermal Derating Chart - I<sub>hold</sub> (Amps)

Model	Ambient Operating Temperature								
	-40 °C	-20 °C	0 °C	23 °C	40 °C	50 °C	60 °C	70 °C	85 °C
MF-USMF005	0.08	0.07	0.06	0.05	0.04	0.04	0.03	0.03	0.02
MF-USMF010	0.15	0.13	0.12	0.10	0.09	0.08	0.07	0.06	0.05
MF-USMF020	0.32	0.28	0.24	0.20	0.18	0.16	0.14	0.12	0.10
MF-USMF035	0.51	0.46	0.40	0.34	0.30	0.27	0.24	0.22	0.18
MF-USMF050	0.76	0.66	0.58	0.48	0.42	0.38	0.35	0.29	0.23
MF-USMF075	1.10	0.97	0.86	0.72	0.64	0.58	0.55	0.47	0.39
MF-USMF110	1.60	1.42	1.26	1.10	0.94	0.86	0.80	0.70	0.58
MF-USMF150	2.30	2.02	1.76	1.43	1.24	1.11	1.00	0.85	0.65
MF-USMF175X	2.80	2.45	2.10	1.75	1.55	1.45	1.35	1.25	1.10

## Typical Time to Trip at 23 °C



The Time to Trip curves represent typical performance of a device in a simulated application environment. Actual performance in specific customer applications may differ from these values due to the influence of other variables.

## How to Order

**MF - USMF 010 X - 2**

Multifuse® Product Designator \_\_\_\_\_

Series \_\_\_\_\_  
 USMF = 1210 Surface Mount Component

Hold Current, I<sub>hold</sub> \_\_\_\_\_  
 005-175 (0.05-1.75 Amps)

Multifuse® freeXpansion™ Design \_\_\_\_\_

Packaging \_\_\_\_\_  
 Packaged per EIA 481-1  
 -2 = Tape and Reel

## Typical Part Marking

Represents total content. Layout may vary.



Asia-Pacific: TEL +886-2 25624117 • FAX +886-2 25624116

Europe: TEL +41-41 7685555 • FAX +41-41 7685510

The Americas: TEL +1-951 781-5500 • FAX +1-951 781-5700

[www.bourns.com](http://www.bourns.com)

MF-USMF SERIES, REV. M, 04/10

“freeXpansion Design” is a trademark of Bourns, Inc.  
 Specifications are subject to change without notice.  
 Customers should verify actual device performance in their specific applications.

# MF-USMF Series Tape and Reel Specifications



## MF-USMF Series per EIA 481-2

### Tape Dimensions

W	$\frac{8.0 \pm 0.3}{(0.315 \pm 0.012)}$
P <sub>0</sub>	$\frac{4.0 \pm 0.1}{(0.157 \pm 0.004)}$
P <sub>1</sub>	$\frac{4.0 \pm 0.1}{(0.157 \pm 0.004)}$
P <sub>2</sub>	$\frac{2.0 \pm 0.05}{(0.079 \pm 0.002)}$
A <sub>0</sub>	$\frac{2.76 \pm 0.10}{(0.109 \pm 0.004)}$
B <sub>0</sub>	$\frac{3.50 \pm 0.10}{(0.138 \pm 0.004)}$
B <sub>1</sub> max.	$\frac{4.35}{(0.171)}$
D <sub>0</sub>	$\frac{1.5 + 0.1/-0.0}{(0.059 + 0.004/-0)}$
F	$\frac{3.5 \pm 0.05}{(0.138 \pm 0.002)}$
E <sub>1</sub>	$\frac{1.75 \pm 0.10}{(0.069 \pm 0.004)}$
E <sub>2</sub> min.	$\frac{6.25}{(0.246)}$
T max.	$\frac{0.6}{(0.024)}$
T <sub>1</sub> max.	$\frac{0.1}{(0.004)}$
K <sub>0</sub>	$\frac{1.07 \pm 0.10}{(0.042 \pm 0.004)}$
Leader min.	$\frac{390}{(15.35)}$
Trailer min.	$\frac{160}{(6.30)}$

### Reel Dimensions

A max.	$\frac{185}{(7.283)}$
N min.	$\frac{50}{(1.97)}$
W <sub>1</sub>	$\frac{8.4 + 1.5/-0.0}{(0.331 + 0.059/-0.0)}$
W <sub>2</sub> max.	$\frac{14.4}{(0.567)}$



Specifications are subject to change without notice.  
Customers should verify actual device performance in their specific applications.

Компания «Океан Электроники» предлагает заключение долгосрочных отношений при поставках импортных электронных компонентов на взаимовыгодных условиях!

Наши преимущества:

- Поставка оригинальных импортных электронных компонентов напрямую с производств Америки, Европы и Азии, а так же с крупнейших складов мира;
- Широкая линейка поставок активных и пассивных импортных электронных компонентов (более 30 млн. наименований);
- Поставка сложных, дефицитных, либо снятых с производства позиций;
- Оперативные сроки поставки под заказ (от 5 рабочих дней);
- Экспресс доставка в любую точку России;
- Помощь Конструкторского Отдела и консультации квалифицированных инженеров;
- Техническая поддержка проекта, помощь в подборе аналогов, поставка прототипов;
- Поставка электронных компонентов под контролем ВП;
- Система менеджмента качества сертифицирована по Международному стандарту ISO 9001;
- При необходимости вся продукция военного и аэрокосмического назначения проходит испытания и сертификацию в лаборатории (по согласованию с заказчиком);
- Поставка специализированных компонентов военного и аэрокосмического уровня качества (Xilinx, Altera, Analog Devices, Intersil, Interpoint, Microsemi, Actel, Aeroflex, Peregrine, VPT, Syfer, Eurofarad, Texas Instruments, MS Kennedy, Miteq, Cobham, E2V, MA-COM, Hittite, Mini-Circuits, General Dynamics и др.);

Компания «Океан Электроники» является официальным дистрибьютором и эксклюзивным представителем в России одного из крупнейших производителей разъемов военного и аэрокосмического назначения «JONHON», а так же официальным дистрибьютором и эксклюзивным представителем в России производителя высокотехнологичных и надежных решений для передачи СВЧ сигналов «FORSTAR».



## JONHON

«JONHON» (основан в 1970 г.)

Разъемы специального, военного и аэрокосмического назначения:

(Применяются в военной, авиационной, аэрокосмической, морской, железнодорожной, горно- и нефтедобывающей отраслях промышленности)

«FORSTAR» (основан в 1998 г.)

ВЧ соединители, коаксиальные кабели, кабельные сборки и микроволновые компоненты:

(Применяются в телекоммуникациях гражданского и специального назначения, в средствах связи, РЛС, а так же военной, авиационной и аэрокосмической отраслях промышленности).



Телефон: 8 (812) 309-75-97 (многоканальный)

Факс: 8 (812) 320-03-32

Электронная почта: [ocean@oceanchips.ru](mailto:ocean@oceanchips.ru)

Web: <http://oceanchips.ru/>

Адрес: 198099, г. Санкт-Петербург, ул. Калинина, д. 2, корп. 4, лит. А