

Phase Control Thyristors (Hockey PUK Version), 990 A



TO-200AC (B-PUK)

FEATURES

- Center amplifying gate
- Metal case with ceramic insulator
- International standard case TO-200AC (B-PUK)
- Designed and qualified for industrial level
- Material categorization: For definitions of compliance please see www.vishay.com/doc?99912

**RoHS
COMPLIANT**
TYPICAL APPLICATIONS

- DC motor controls
- Controlled DC power supplies
- AC controllers

PRODUCT SUMMARY	
Package	TO-200AC (B-PUK)
Diode variation	Single SCR
$I_{T(AV)}$	990 A
V_{DRM}/V_{RRM}	800 V, 1200 V, 1400 V, 1600 V, 1800 V, 2000 V
V_{TM}	1.62 V
I_{GT}	100 mA
T_J	-40 °C to 125 °C

MAJOR RATINGS AND CHARACTERISTICS			
PARAMETER	TEST CONDITIONS	VALUES	UNITS
$I_{T(AV)}$		990	A
	T_{hs}	55	°C
$I_{T(RMS)}$		2000	A
	T_{hs}	25	°C
I_{TSM}	50 Hz	17 800	A
	60 Hz	18 700	
I^2t	50 Hz	1591	kA ² s
	60 Hz	1452	
V_{DRM}/V_{RRM}		800 to 2000	V
t_q	Typical	150	µs
T_J		-40 to 125	°C

VOLTAGE RATINGS				
TYPE NUMBER	VOLTAGE CODE	V_{DRM}/V_{RRM} , MAXIMUM REPETITIVE PEAK AND OFF-STATE VOLTAGE V	V_{RSM} , MAXIMUM NON-REPETITIVE PEAK VOLTAGE V	I_{DRM}/I_{RRM} MAXIMUM AT $T_J = T_J$ MAXIMUM mA
VS-ST730CL	08	800	900	80
	12	1200	1300	
	14	1400	1500	
	16	1600	1700	
	18	1800	1900	
	20	2000	2100	



ABSOLUTE MAXIMUM RATINGS					
PARAMETER	SYMBOL	TEST CONDITIONS		VALUES	UNITS
Maximum average on-state current at heatsink temperature	$I_{T(AV)}$	180° conduction, half sine wave double side (single side) cooled		990 (375)	A
				55 (85)	°C
Maximum RMS on-state current	$I_{T(RMS)}$	DC at 25 °C heatsink temperature double side cooled		2000	A
Maximum peak, one-cycle non-repetitive surge current	I_{TSM}	t = 10 ms	No voltage reapplied	17 800	
		t = 8.3 ms		18 700	
		t = 10 ms	100 % V_{RRM} reapplied	15 000	
		t = 8.3 ms		15 700	
Maximum I^2t for fusing	I^2t	t = 10 ms	No voltage reapplied	1591	kA ² s
		t = 8.3 ms		1452	
		t = 10 ms	100 % V_{RRM} reapplied	1125	
		t = 8.3 ms		1027	
Maximum $I^2\sqrt{t}$ for fusing	$I^2\sqrt{t}$	t = 0.1 to 10 ms, no voltage reapplied		15 910	kA ² √s
Low level value of threshold voltage	$V_{T(TO)1}$	(16.7 % $\times \pi \times I_{T(AV)} < I < \pi \times I_{T(AV)}$, $T_J = T_J$ maximum)		0.98	V
High level value of threshold voltage	$V_{T(TO)2}$	(I $> \pi \times I_{T(AV)}$, $T_J = T_J$ maximum)		1.12	
Low level value of on-state slope resistance	$r_{\theta 1}$	(16.7 % $\times \pi \times I_{T(AV)} < I < \pi \times I_{T(AV)}$, $T_J = T_J$ maximum)		0.32	mΩ
High level value of on-state slope resistance	$r_{\theta 2}$	(I $> \pi \times I_{T(AV)}$, $T_J = T_J$ maximum)		0.27	
Maximum on-state voltage	V_{TM}	$I_{pk} = 2000$ A, $T_J = T_J$ maximum, $t_p = 10$ ms sine pulse		1.62	V
Maximum holding current	I_H	$T_J = 25$ °C, anode supply 12 V resistive load		600	mA
Typical latching current	I_L			1000	

SWITCHING					
PARAMETER	SYMBOL	TEST CONDITIONS		VALUES	UNITS
Maximum non-repetitive rate of rise of turned-on current	di/dt	Gate drive 20 V, 20 Ω, $t_r \leq 1$ μs $T_J = T_J$ maximum, anode voltage ≤ 80 % V_{DRM}		1000	A/μs
Typical delay time	t_d	Gate current 1 A, $dI_g/dt = 1$ A/μs $V_d = 0.67$ % V_{DRM} , $T_J = 25$ °C		1.0	μs
Typical turn-off time	t_q	$I_{TM} = 750$ A, $T_J = T_J$ maximum, di/dt = 60 A/μs, $V_R = 50$ V, dV/dt = 20 V/μs, gate 0 V 100 Ω, $t_p = 500$ μs		150	

BLOCKING					
PARAMETER	SYMBOL	TEST CONDITIONS		VALUES	UNITS
Maximum critical rate of rise of off-state voltage	dV/dt	$T_J = T_J$ maximum linear to 80 % rated V_{DRM}		500	V/μs
Maximum peak reverse and off-state leakage current	I_{RRM} , I_{DRM}	$T_J = T_J$ maximum, rated V_{DRM}/V_{RRM} applied		80	mA



TRIGGERING						
PARAMETER	SYMBOL	TEST CONDITIONS	VALUES		UNITS	
			Typ.	Max.		
Maximum peak gate power	P_{GM}	$T_J = T_J$ maximum, $t_p \leq 5$ ms	10.0		W	
Maximum average gate power	$P_{G(AV)}$	$T_J = T_J$ maximum, $f = 50$ Hz, $d\% = 50$	2.0			
Maximum peak positive gate current	I_{GM}	$T_J = T_J$ maximum, $t_p \leq 5$ ms	3.0		A	
Maximum peak positive gate voltage	$+V_{GM}$	$T_J = T_J$ maximum, $t_p \leq 5$ ms	20		V	
Maximum peak negative gate voltage	$-V_{GM}$		5.0			
DC gate current required to trigger	I_{GT}	$T_J = -40$ °C	Maximum required gate trigger/ current/voltage are the lowest value which will trigger all units 12 V anode to cathode applied	200	-	mA
		$T_J = 25$ °C		100	200	
		$T_J = 125$ °C		50	-	
DC gate voltage required to trigger	V_{GT}	$T_J = -40$ °C		2.5	-	V
		$T_J = 25$ °C		1.8	3.0	
		$T_J = 125$ °C		1.1	-	
DC gate current not to trigger	I_{GD}	$T_J = T_J$ maximum	10		mA	
DC gate voltage not to trigger	V_{GD}		0.25		V	

THERMAL AND MECHANICAL SPECIFICATIONS				
PARAMETER	SYMBOL	TEST CONDITIONS	VALUES	UNITS
Maximum operating junction temperature range	T_J		-40 to 125	°C
Maximum storage temperature range	T_{Stg}		-40 to 150	
Maximum thermal resistance, junction to heatsink	R_{thJ-hs}	DC operation single side cooled	0.073	K/W
		DC operation double side cooled	0.031	
Maximum thermal resistance, case to heatsink	R_{thC-hs}	DC operation single side cooled	0.011	
		DC operation double side cooled	0.006	
Mounting force, ± 10 %			14 700 (1500)	N (kg)
Approximate weight			255	g
Case style		See dimensions - link at the end of datasheet	TO-200AC (B-PUK)	

ΔR_{thJ-hs} CONDUCTION						
CONDUCTION ANGLE	SINUSOIDAL CONDUCTION		RECTANGULAR CONDUCTION		TEST CONDITIONS	UNITS
	SINGLE SIDE	DOUBLE SIDE	SINGLE SIDE	DOUBLE SIDE		
180°	0.009	0.009	0.006	0.006	$T_J = T_J$ maximum	K/W
120°	0.011	0.011	0.010	0.011		
90°	0.014	0.014	0.015	0.015		
60°	0.020	0.020	0.021	0.021		
30°	0.036	0.036	0.036	0.036		

Note

- The table above shows the increment of thermal resistance R_{thJ-hs} when devices operate at different conduction angles than DC

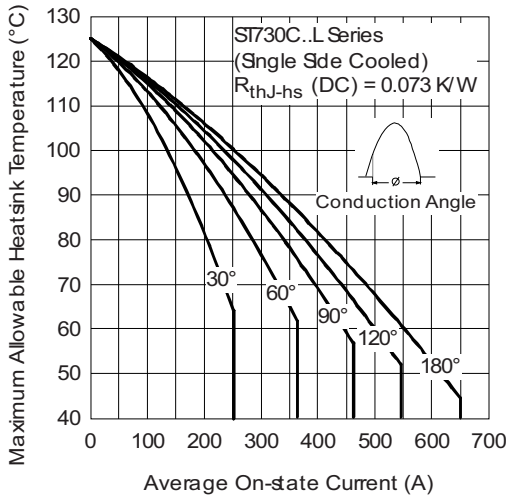

Fig. 1 - Current Ratings Characteristics

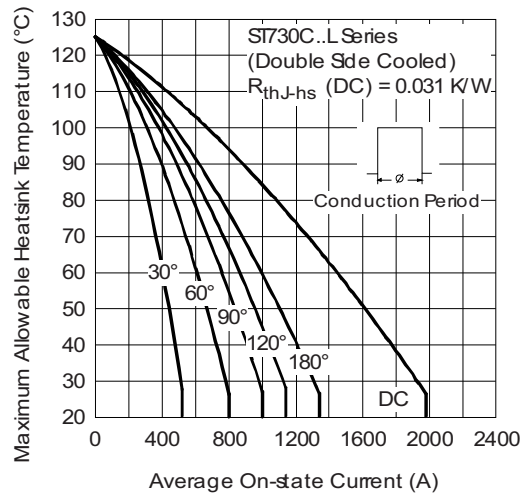

Fig. 4 - Current Ratings Characteristics

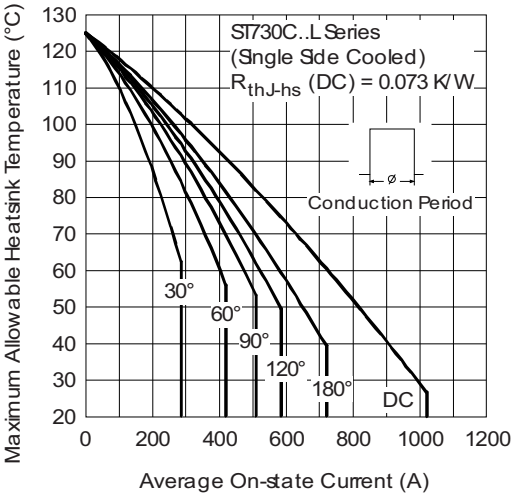

Fig. 2 - Current Ratings Characteristics

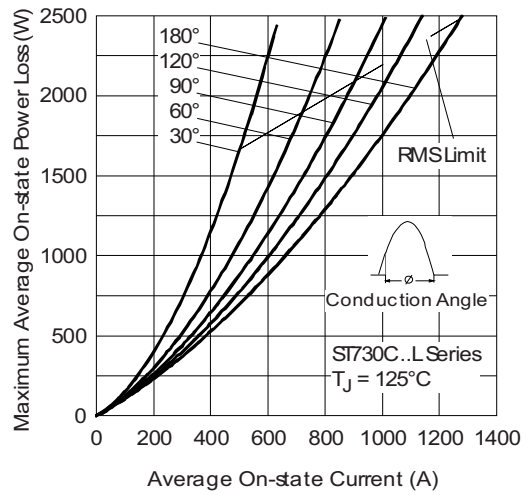

Fig. 5 - On-State Power Loss Characteristics

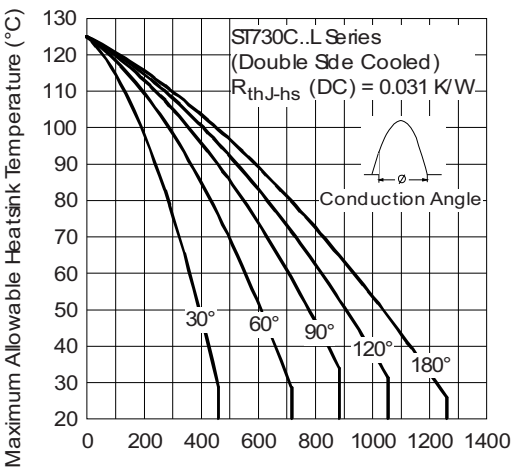

Fig. 3 - Current Ratings Characteristics

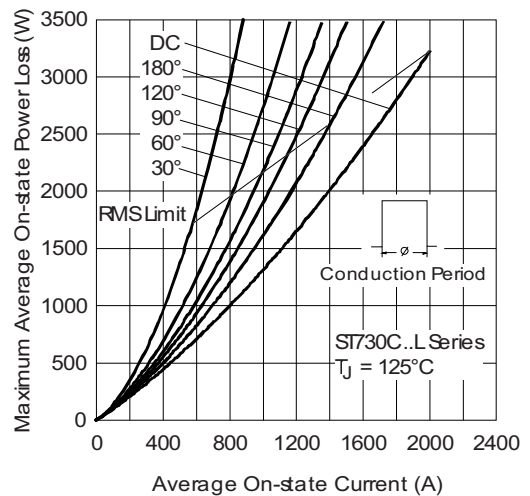

Fig. 6 - On-State Power Loss Characteristics

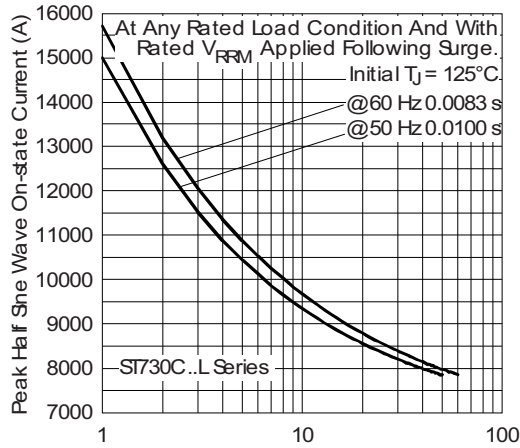

Fig. 7 - Maximum Non-Repetitive Surge Current Single and Double Side Cooled

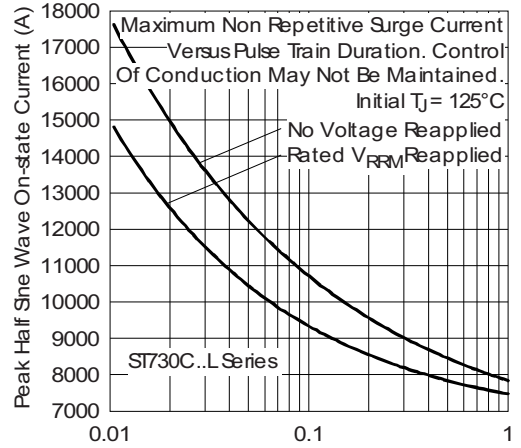

Fig. 8 - Maximum Non-Repetitive Surge Current Single and Double Side Cooled

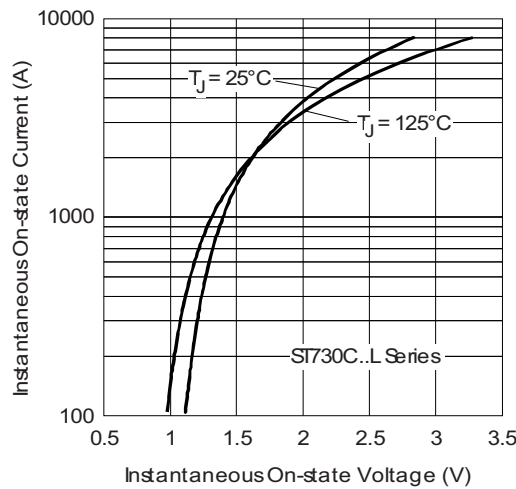

Fig. 9 - On-State Voltage Drop Characteristics

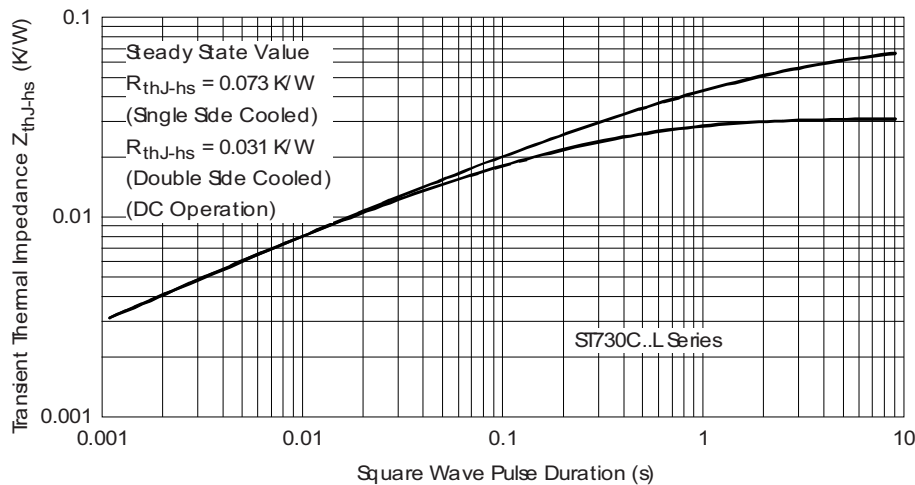

Fig. 10 - Thermal Impedance Z_{thJ-hs} Characteristics

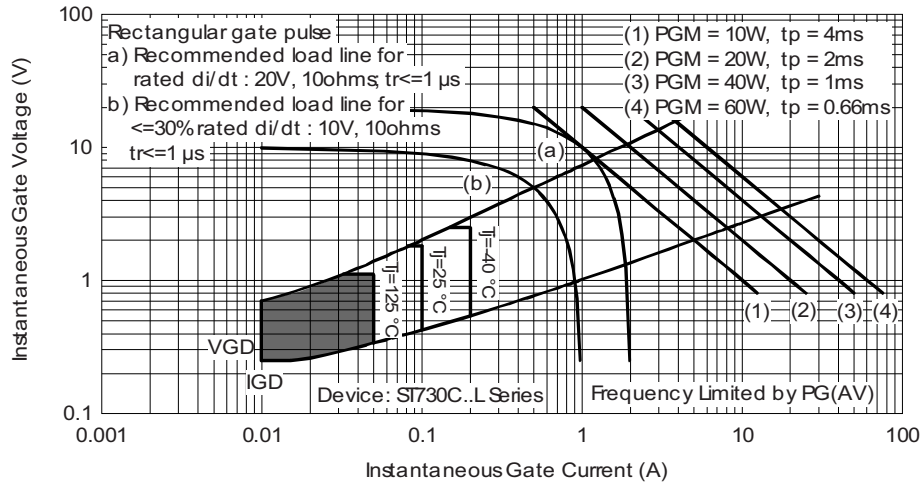

Fig. 11 - Gate Characteristics

ORDERING INFORMATION TABLE

Device code	VS-	ST	73	0	C	20	L	1	-
	(1)	(2)	(3)	(4)	(5)	(6)	(7)	(8)	(9)

- 1** - Vishay Semiconductors product
- 2** - Thyristor
- 3** - Essential part number
- 4** - 0 = Converter grade
- 5** - C = Ceramic PUK
- 6** - Voltage code x 100 = V_{RRM} (see Voltage Ratings table)
- 7** - L = PUK case TO-200AC (B-PUK)
- 8** - 0 = Eyelet terminals (gate and auxiliary cathode unsoldered leads)
 1 = Fast-on terminals (gate and auxiliary cathode unsoldered leads)
 2 = Eyelet terminals (gate and auxiliary cathode soldered leads)
 3 = Fast-on terminals (gate and auxiliary cathode soldered leads)
- 9** - Critical dV/dt : • None = 500 V/ μs (standard selection)
 • L = 1000 V/ μs (special selection)

LINKS TO RELATED DOCUMENTS

Dimensions	www.vishay.com/doc?95076
------------	--

TO-200AC (B-PUK)

DIMENSIONS in millimeters (inches)

Creepage distance: 36.33 (1.430) minimum
 Strike distance: 17.43 (0.686) minimum

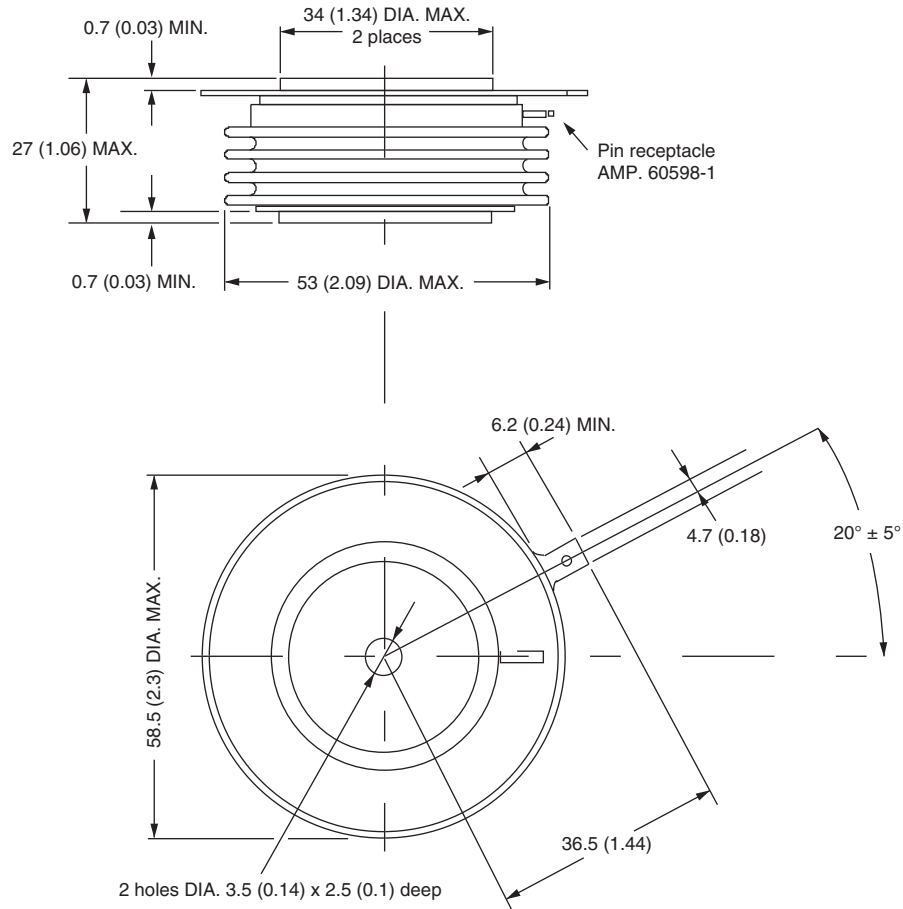

Quote between upper and lower pole pieces has to be considered after application of mounting force (see thermal and mechanical specification)



Disclaimer

ALL PRODUCT, PRODUCT SPECIFICATIONS AND DATA ARE SUBJECT TO CHANGE WITHOUT NOTICE TO IMPROVE RELIABILITY, FUNCTION OR DESIGN OR OTHERWISE.

Vishay Intertechnology, Inc., its affiliates, agents, and employees, and all persons acting on its or their behalf (collectively, "Vishay"), disclaim any and all liability for any errors, inaccuracies or incompleteness contained in any datasheet or in any other disclosure relating to any product.

Vishay makes no warranty, representation or guarantee regarding the suitability of the products for any particular purpose or the continuing production of any product. To the maximum extent permitted by applicable law, Vishay disclaims (i) any and all liability arising out of the application or use of any product, (ii) any and all liability, including without limitation special, consequential or incidental damages, and (iii) any and all implied warranties, including warranties of fitness for particular purpose, non-infringement and merchantability.

Statements regarding the suitability of products for certain types of applications are based on Vishay's knowledge of typical requirements that are often placed on Vishay products in generic applications. Such statements are not binding statements about the suitability of products for a particular application. It is the customer's responsibility to validate that a particular product with the properties described in the product specification is suitable for use in a particular application. Parameters provided in datasheets and/or specifications may vary in different applications and performance may vary over time. All operating parameters, including typical parameters, must be validated for each customer application by the customer's technical experts. Product specifications do not expand or otherwise modify Vishay's terms and conditions of purchase, including but not limited to the warranty expressed therein.

Except as expressly indicated in writing, Vishay products are not designed for use in medical, life-saving, or life-sustaining applications or for any other application in which the failure of the Vishay product could result in personal injury or death. Customers using or selling Vishay products not expressly indicated for use in such applications do so at their own risk. Please contact authorized Vishay personnel to obtain written terms and conditions regarding products designed for such applications.

No license, express or implied, by estoppel or otherwise, to any intellectual property rights is granted by this document or by any conduct of Vishay. Product names and markings noted herein may be trademarks of their respective owners.

Material Category Policy

Vishay Intertechnology, Inc. hereby certifies that all its products that are identified as RoHS-Compliant fulfill the definitions and restrictions defined under Directive 2011/65/EU of The European Parliament and of the Council of June 8, 2011 on the restriction of the use of certain hazardous substances in electrical and electronic equipment (EEE) - recast, unless otherwise specified as non-compliant.

Please note that some Vishay documentation may still make reference to RoHS Directive 2002/95/EC. We confirm that all the products identified as being compliant to Directive 2002/95/EC conform to Directive 2011/65/EU.

Vishay Intertechnology, Inc. hereby certifies that all its products that are identified as Halogen-Free follow Halogen-Free requirements as per JEDEC JS709A standards. Please note that some Vishay documentation may still make reference to the IEC 61249-2-21 definition. We confirm that all the products identified as being compliant to IEC 61249-2-21 conform to JEDEC JS709A standards.

Компания «Океан Электроники» предлагает заключение долгосрочных отношений при поставках импортных электронных компонентов на взаимовыгодных условиях!

Наши преимущества:

- Поставка оригинальных импортных электронных компонентов напрямую с производств Америки, Европы и Азии, а так же с крупнейших складов мира;
- Широкая линейка поставок активных и пассивных импортных электронных компонентов (более 30 млн. наименований);
- Поставка сложных, дефицитных, либо снятых с производства позиций;
- Оперативные сроки поставки под заказ (от 5 рабочих дней);
- Экспресс доставка в любую точку России;
- Помощь Конструкторского Отдела и консультации квалифицированных инженеров;
- Техническая поддержка проекта, помощь в подборе аналогов, поставка прототипов;
- Поставка электронных компонентов под контролем ВП;
- Система менеджмента качества сертифицирована по Международному стандарту ISO 9001;
- При необходимости вся продукция военного и аэрокосмического назначения проходит испытания и сертификацию в лаборатории (по согласованию с заказчиком);
- Поставка специализированных компонентов военного и аэрокосмического уровня качества (Xilinx, Altera, Analog Devices, Intersil, Interpoint, Microsemi, Actel, Aeroflex, Peregrine, VPT, Syfer, Eurofarad, Texas Instruments, MS Kennedy, Miteq, Cobham, E2V, MA-COM, Hittite, Mini-Circuits, General Dynamics и др.);

Компания «Океан Электроники» является официальным дистрибьютором и эксклюзивным представителем в России одного из крупнейших производителей разъемов военного и аэрокосмического назначения «JONHON», а так же официальным дистрибьютором и эксклюзивным представителем в России производителя высокотехнологичных и надежных решений для передачи СВЧ сигналов «FORSTAR».



JONHON

«JONHON» (основан в 1970 г.)

Разъемы специального, военного и аэрокосмического назначения:

(Применяются в военной, авиационной, аэрокосмической, морской, железнодорожной, горно- и нефтедобывающей отраслях промышленности)

«FORSTAR» (основан в 1998 г.)

ВЧ соединители, коаксиальные кабели, кабельные сборки и микроволновые компоненты:

(Применяются в телекоммуникациях гражданского и специального назначения, в средствах связи, РЛС, а так же военной, авиационной и аэрокосмической отраслях промышленности).



Телефон: 8 (812) 309-75-97 (многоканальный)

Факс: 8 (812) 320-03-32

Электронная почта: ocean@oceanchips.ru

Web: <http://oceanchips.ru/>

Адрес: 198099, г. Санкт-Петербург, ул. Калинина, д. 2, корп. 4, лит. А