

DELPHI SERIES



FEATURES

- ♦ High efficiency: 96.7% @ half Load
- ♦ Size:
58.4 x 36.8 x 12.7mm (2.30"x1.45"x0.50")
- ♦ PMBus Rev.1.2 compliance
- ♦ Industry standard, DOSA compliant pin out
- ♦ Fixed frequency operation
- ♦ Input UVLO, Output OCP & OVP, OTP
- ♦ Monotonic startup into normal and Pre-biased loads
- ♦ 2250V Isolation and basic insulation
- ♦ No minimum load required
- ♦ ISO 9001, TL 9000, ISO 14001, QS 9000, OHSAS 18001 certified manufacturing facility
- ♦ UL/cUL 60950-1 (US & Canada) recognized

Delphi Series Q54SG Quarter Brick Family Full Digital Control DC/DC Power Modules: 54V In, 12V/50A Out

The Delphi Series Q54SG, 40~60V input, isolated single output, Quarter Brick, are full digital control DC/DC converters, and are the latest offering from a world leader in power systems technology and manufacturing — Delta Electronics, Inc. The Q54SG series provide up to 600 watts of power in an industry standard, DOSA compliant footprint and pin out; The typical efficiency is 96.7% at 12V/25A load, and 96% at 12V/50A load. There is a built-in digital PWM controller in the Q54SG series, which is used to complete the V_o feedback, PWM signal generation, fault protection, and PMBUS communications, and so on. With the digital control, many design and application flexibility, advanced performance, and reliability are obtained;

OPTIONS

- ♦ With/without Digital PMBus interface
- ♦ Optional Analog Trim
- ♦ Negative/Positive On/Off logic

APPLICATIONS

- ♦ Telecom / DataCom
- ♦ Wireless Networks
- ♦ Optical Network Equipment
- ♦ Server and Data Storage
- ♦ Industrial/Test Equipment

Datasheet

DS_Q54SG12050_04272016

TECHNICAL SPECIFICATIONS

(T_A=25°C, airflow rate=300 LFM, V_{in}=54Vdc, nominal V_{out} unless otherwise noted.)

PARAMETER	NOTES and CONDITIONS	Q54SG12050			
		Min.	Typ.	Max.	Units
ABSOLUTE MAXIMUM RATINGS					
Input Voltage					
Continuous				60	Vdc
Transient (100ms)	100ms			70	Vdc
On/off Pin Voltage		-50		50	V
Other Pin Voltage	Trim/Current Sharing, C2, Data, SMBAlert, Clock, Addr1, Addr0	-0.3		3.6	V
Operating Ambient Temperature		-40		85	°C
Storage Temperature		-55		125	°C
Input/Output Isolation Voltage				2250	Vdc
INPUT CHARACTERISTICS					
Operating Input Voltage		40		60	Vdc
Input Under-Voltage Lockout					
Turn-On Voltage Threshold		38.8	39.4	39.8	Vdc
Turn-Off Voltage Threshold		37	37.7	38.2	Vdc
Lockout Hysteresis Voltage		1		3	Vdc
Maximum Input Current	V _{in} =40V, 100% Load,		15.7	15.9	A
No-Load Input Current			90	135	mA
Off Converter Input Current			18	23	mA
Inrush Current(I [†])	With 100uF external input capacitor			1	A*s
Start up Current	Peak, 100% Load, With 5000uF Co		15	20	A
Input Terminal Ripple Current	RMS, With 100uF input cap.		0.85	1	A
Input Reflected-Ripple Current	P-P thru 12uH inductor, 5Hz to 20MHz		70	100	mA
Input Voltage Ripple Rejection	120 Hz		50		dB
OUTPUT CHARACTERISTICS					
Output Voltage Set Point(without current sharing)	V _{in} =54, Tc=25°C	11.88	12	12.12	Vdc
Output Voltage Set Point(with current sharing)	V _{in} =54V, I _o =I _{o.min} , Tc=25°C	12.1	12.125	12.15	Vdc
Output Voltage Set Point(with current sharing)	V _{in} =54V, I _o =I _{o.max} , Tc=25°C	11.85	11.875	11.9	Vdc
Output Voltage Regulation					
Over Load(without current sharing)	I _o =I _{o.min} to I _{o.max}	-60		60	mV
Over Load(with current sharing)	V _o at I _{o.min} - V _o at I _{o.max} under 25°C	200	250	300	mV
Over Line	V _{in} =40V to 60V, 100% Load		30		mV
Over Temperature	Tc=-40°C to 125°C		-120		mV
Total Output Voltage Range (without current sharing)	over sample load, and temperature, from 40~60V V _{in}	11.7		12.3	V
Total Output Voltage Range (with current sharing)	over sample load, and temperature, from 40~60V V _{in}	11.6		12.4	V
Output Voltage Ripple and Noise	5Hz to 20MHz bandwidth				
Peak-to-Peak	Full Load, 1uF ceramic, 10uF tantalum		150	250	mV
RMS	Full Load, 1uF ceramic, 10uF tantalum		60	100	mV
Operating Output Current Range	Full input voltage range	0		50	A
Output DC Current-Limit Inception	Output Voltage 10% Low	110		140	%
Output Voltage Trim Range	V _{in} =54V	-20		10	%
DYNAMIC CHARACTERISTICS					
Output Voltage Current Transient	54V, 10uF Tan & 1uF Ceramic load cap, 0.1A/us				
Positive Step Change in Output Current	50% I _{o.max} to 75% I _{o.max}		250	450	mV
Negative Step Change in Output Current	75% I _{o.max} to 50% I _{o.max}		250	450	mV
Setting Time (within 1% V _{out} nominal)				300	us
Turn-On Transient					
Start-up delay time by On/off, from On/off to 10%V _{o.set}	V _{in} =54V, with current sharing / without current sharing		110/70	150/100	ms
Start-up delay time by V _{in} , from Input to 10%V _{o.set}	V _{in} =54V, with current sharing / without current sharing		120/80	160/110	ms
Output rise time, from 10%V _{o.set} to 90%V _{o.set}	V _{in} =54V, with current sharing / without current sharing		200/25		ms
Output Capacitance		220		16000	uF
EFFICIENCY					
60% Load(without current sharing)	V _{in} =54V		96.7		%
100% Load(without current sharing)	V _{in} =54V		96		%
60% Load(with current sharing)	V _{in} =54V		96.3		%
100% Load(with current sharing)	V _{in} =54V		95.8		%
ISOLATION CHARACTERISTICS					
Input to Output				2250	Vdc
Isolation Resistance		10			MΩ
Isolation Capacitance			1500		pF
FEATURE CHARACTERISTICS					
Switching Frequency			130		kHz
ON/OFF Control					
Logic Low	V _{on/off}	-0.7		0.8	V
Logic High	V _{on/off}	2.4		50	V
ON/OFF Current (for both remote on/off logic)	I _{on/off} at V _{on/off} =0.0V			0.5	mA
ON/OFF Current (for both remote on/off logic)	I _{on/off} at V _{on/off} =2.4V	10			uA
Leakage Current (for both remote on/off logic)	Logic High, V _{on/off} =15V			50	uA
Output Voltage Trim Range	V _{in} =54V, P _{out} ≤ max rated power	-20		10	%
Output Over-Voltage Protection	Over full temp range: % of nominal V _{out}	14		17	V

TECHNICAL SPECIFICATIONS

(T_A=25°C, airflow rate=300 LFM, V_{in}=54Vdc, nominal V_{out} unless otherwise noted.)

PARAMETER	NOTES and CONDITIONS	Q54SG12050			
		Min.	Typ.	Max.	Units
PMBus Signal Interface Characteristics					
Logic Input Low (V _{IL})	C2, Data, SMBAlert, Clock pin	0		0.8	V
Logic Input High (V _{IH})	C2, Data, SMBAlert, Clock pin	2.1		3.3	V
Logic Output Low (V _{OL})	C2, Data, SMBAlert, Clock pin; I _{OL} =6mA			0.4	V
Logic Output High (V _{OH})	C2, Data, SMBAlert, Clock pin; I _{OH} =-6mA	2.6			V
PMBus Operating Frequency Range		100		400	KHz
PMBus Monitoring CHARACTERISTICS					
Output Current Reading Accuracy	I _o =50% ~ 100% of I _{o, max} ;	-5		+5	%
	I _o =5% ~ 50% of I _{o, max} ;	-2		+2	A
Output Voltage Reading Accuracy		-2		+2	%
Input Voltage Reading Accuracy		-4		+4	%
Temperature Reading Accuracy		-5		+5	°C
GENERAL SPECIFICATIONS					
MTBF	I _o =80% of I _{o, max} ; 300LFM; T _a =25°C		1.56		M hours
Weight			66.5		grams
Over-Temperature Shutdown (With heat spreader)	Refer to Figure 19 for Hot spot 1 location (54V _{in} , 80% I _o , 200LFM, Airflow from Vin- to Vin+)		112		°C
Over-Temperature Shutdown (With 0.5" height heat sink)	Refer to Figure 22 for Hot spot 2 location (54V _{in} , 80% I _o , 200LFM, Airflow from Vin- to Vin+)		103		°C
Over-Temperature Shutdown (NTC resistor)			125		°C
Note: Please attach thermocouple on NTC resistor to test OTP function, the hot spots' temperature is just for reference.					

PIN DEFINATION

Pin#	Name	Function	Pin#	Name	Function
1	VIN(+)		7	C2	Secondary on/off control pin; The default configuration is set to ignore this input. And such pin can be reconfigured by the PMBus Interface.
2	ON/OFF	Primary on/off control pin	8	Sig_Gnd	Signal ground
3	VIN(-)		9	Data	PMBus data line
4	VOU(-)		10	SMBAlert	PMBus SMBAlert line
5	Trim	Trim pin	11	Clock	PMBus clock line
6	VOU(+)		12	Addr1	ADDR1 pin sets the high order digit of the address.
			13	Addr0	ADDR0 pin sets the low order digit of the address.

SIMPLIFIED APPLICATION CIRCUIT

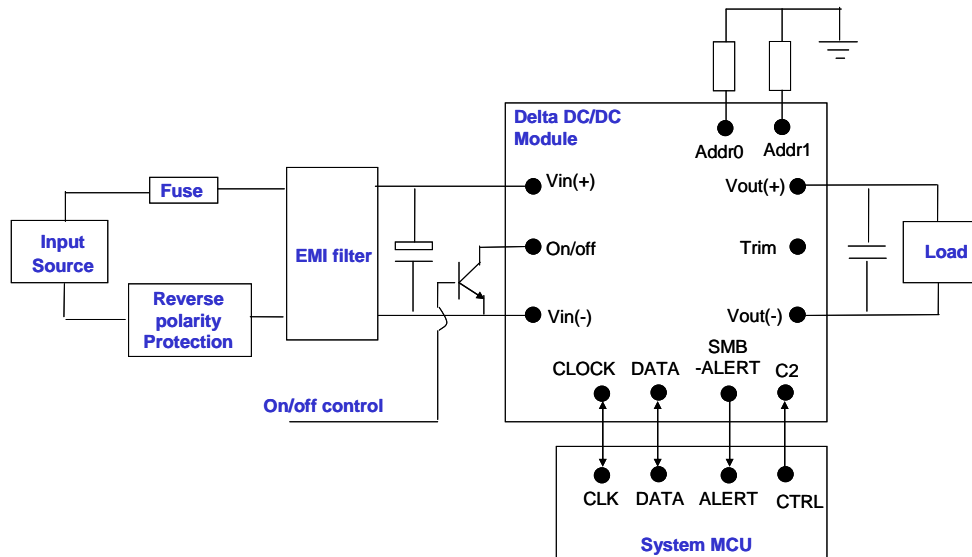

ELECTRICAL CHARACTERISTICS CURVES

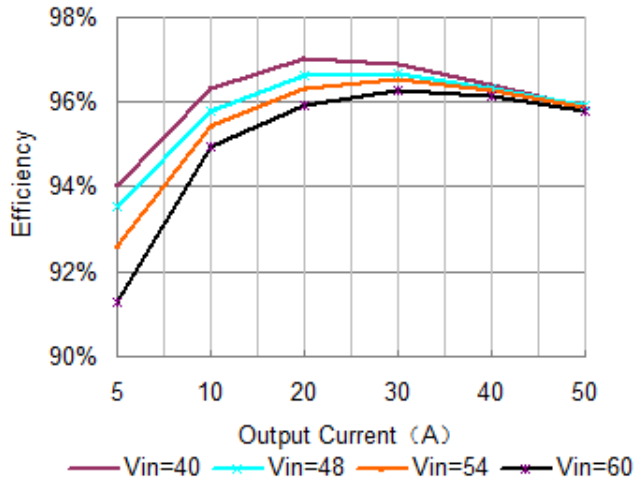

Figure 1: Efficiency vs. load current for minimum, nominal, and maximum input voltage at 25°C (For module without current sharing)

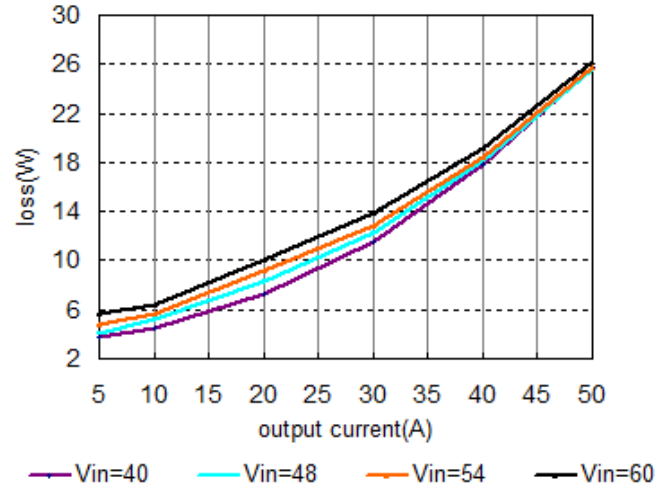

Figure 2: Power dissipation vs. load current for minimum, nominal, and maximum input voltage at 25°C (For module without current sharing)

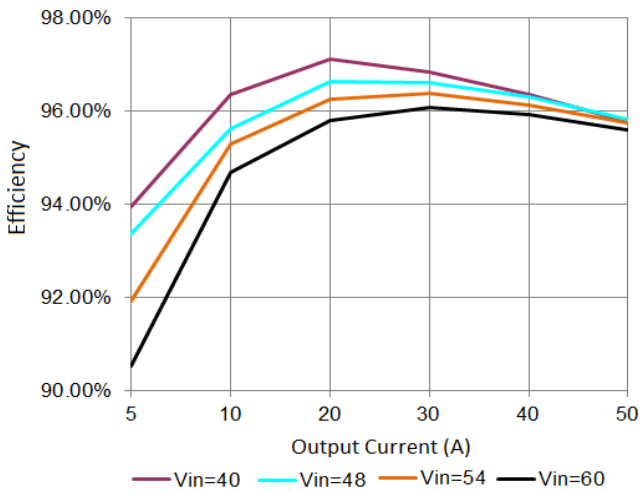

Figure 3: Efficiency vs. load current for minimum, nominal, and maximum input voltage at 25°C (For module with current sharing)

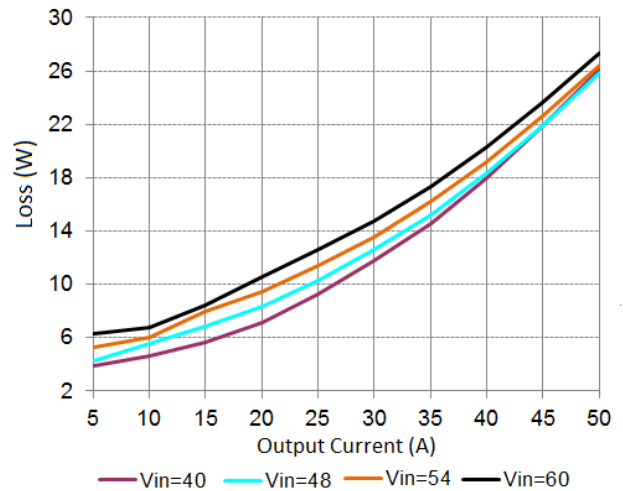

Figure 4: Power dissipation vs. load current for minimum, nominal, and maximum input voltage at 25°C (For module with current sharing)

ELECTRICAL CHARACTERISTICS CURVES

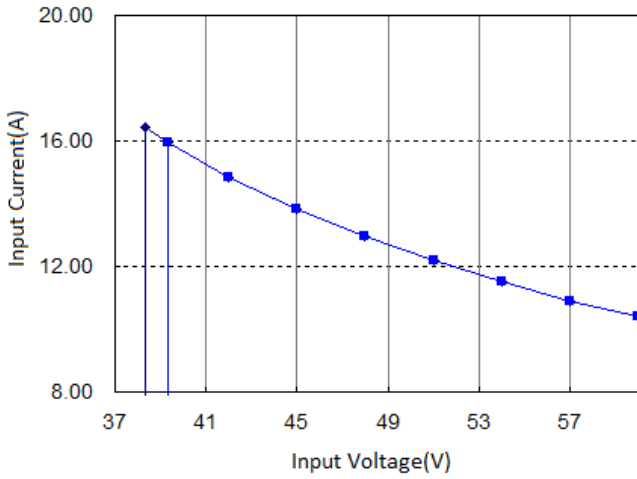

Figure 5: Typical full load input characteristics at room temperature

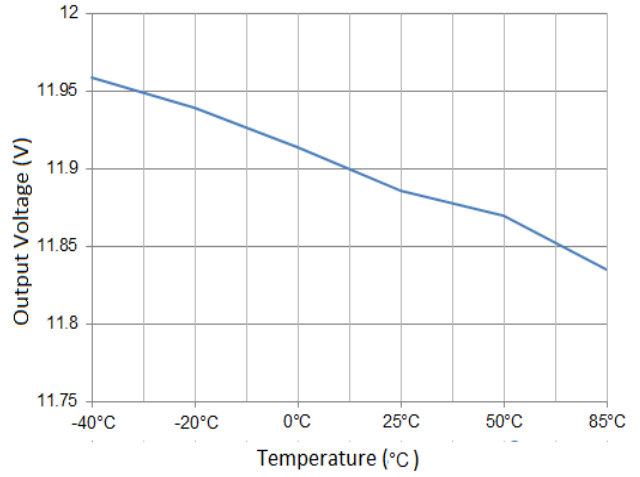

Figure 6: Typical Vo set point vs temperature (For module with current sharing), 54Vin with full load.

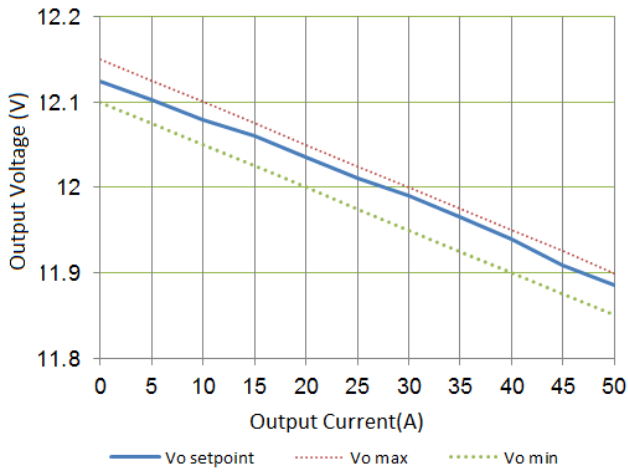

Figure 7: Typical Output voltage vs output current (For module with current sharing), 54Vin under room temperature.

ELECTRICAL CHARACTERISTICS CURVES

For Negative Remote On/Off Logic

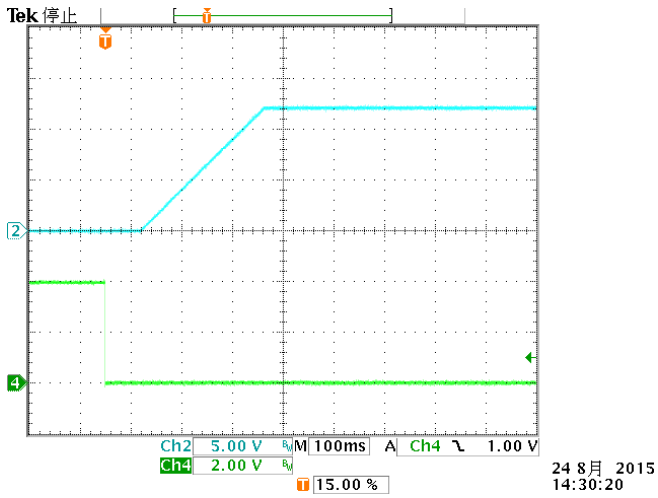

Figure 8: Turn-on transient at zero load current (10ms/div), $V_{in}=54V$; Top Trace: V_{out} , 5V/div; Bottom Trace: ON/OFF input, 2V/div;

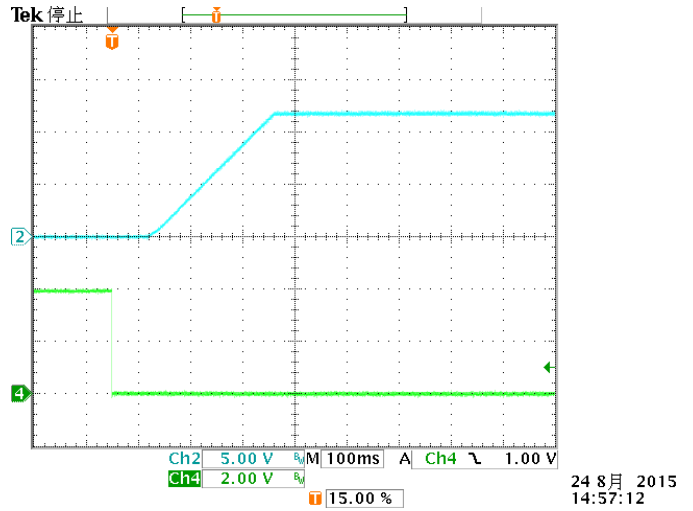

Figure 9: Turn-on transient at full rated load current (constant current load) (10 ms/div), $V_{in}=54V$; Top Trace: V_{out} , 5V/div; Bottom Trace: ON/OFF input, 2V/div;

For Input Voltage Start up

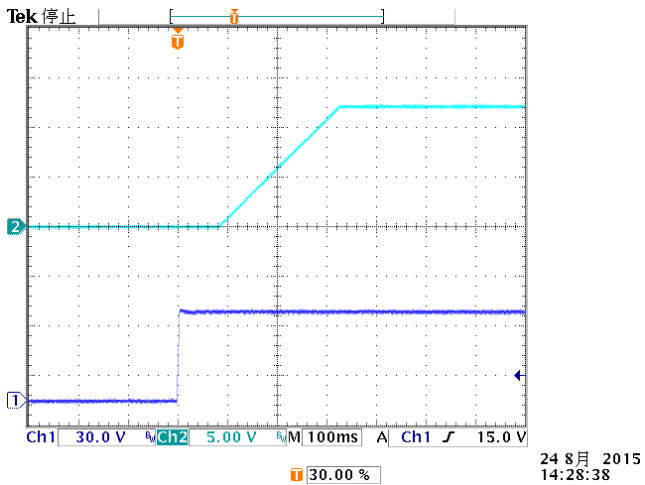

Figure 10: Turn-on transient at zero load current (10 ms/div), $V_{in}=54V$; Top Trace: V_{out} , 5V/div; Bottom Trace: input voltage, 30V/div;

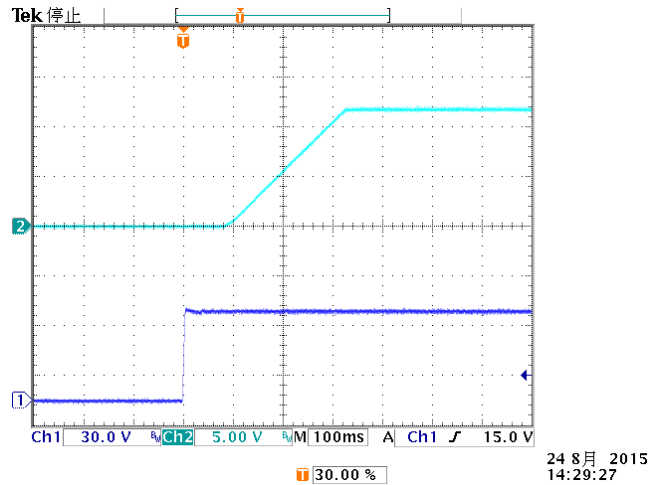

Figure 11: Turn-on transient at full rated load current (constant current load) (10 ms/div), $V_{in}=54V$; Top Trace: V_{out} , 5V/div; Bottom Trace: input voltage, 30V/div;

ELECTRICAL CHARACTERISTICS CURVES

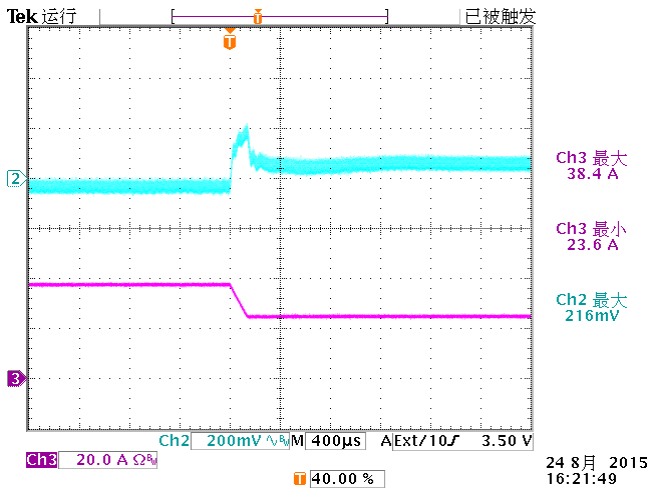

Figure 12: Output voltage response to step-change in load current (75%-50% of I_o , max; $di/dt = 0.1A/\mu s$, $V_{in}=54V$). Load cap: $10\mu F$, tantalum capacitor and $1\mu F$ ceramic capacitor. Top Trace: V_{out} (200mV/div, 400us/div); Bottom Trace: I_o (20A/div, 400us/div). Scope measurement should be made using a BNC cable (length shorter than 20 inches). Position the load between 51 mm to 76 mm (2 inches to 3 inches) from the module.

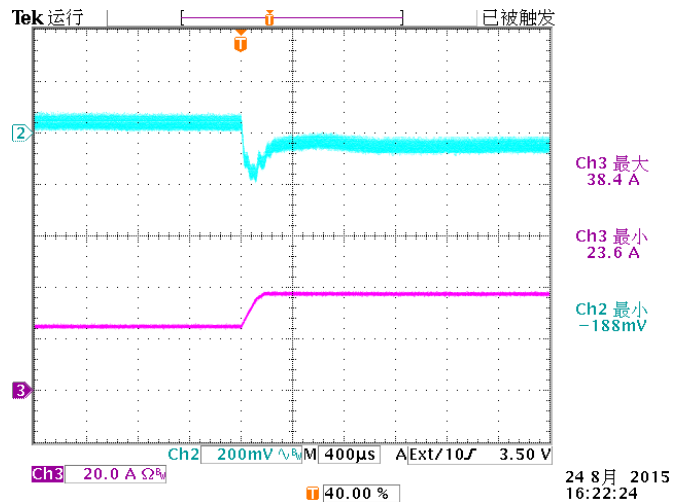

Figure 13: Output voltage response to step-change in load current (50%-75% of I_o , max; $di/dt = 0.1A/\mu s$, $V_{in}=54V$). Load cap: $10\mu F$, tantalum capacitor and $1\mu F$ ceramic capacitor. Top Trace: V_{out} (200mV/div, 400us/div); Bottom Trace: I_o (20A/div, 400us/div). Scope measurement should be made using a BNC cable (length shorter than 20 inches). Position the load between 51 mm to 76 mm (2 inches to 3 inches) from the module.

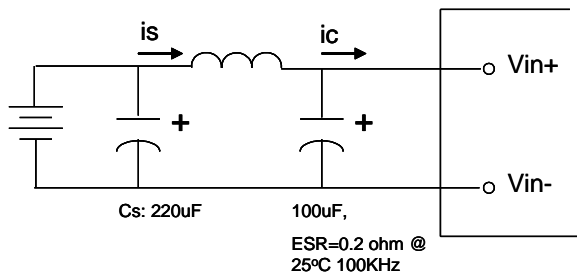

Figure 14: Test set-up diagram showing measurement points for Input Terminal Ripple Current and Input Reflected Ripple Current.

Note: Measured input reflected-ripple current with a simulated source Inductance (L_{TEST}) of $12\mu H$. Capacitor C_s offset possible battery impedance. Measure current as shown below

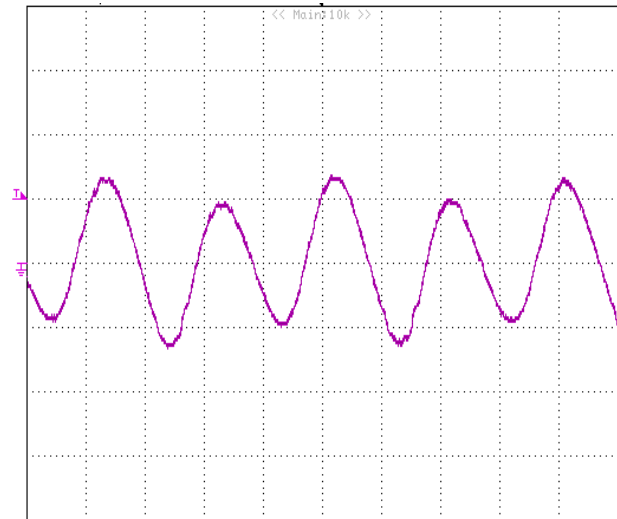

Figure 15: Input Terminal Ripple Current, i_c , at full rated output current and nominal input voltage with $12\mu H$ source impedance and $100\mu F$ electrolytic capacitor (500 mA/div, 2us/div).

ELECTRICAL CHARACTERISTICS CURVES

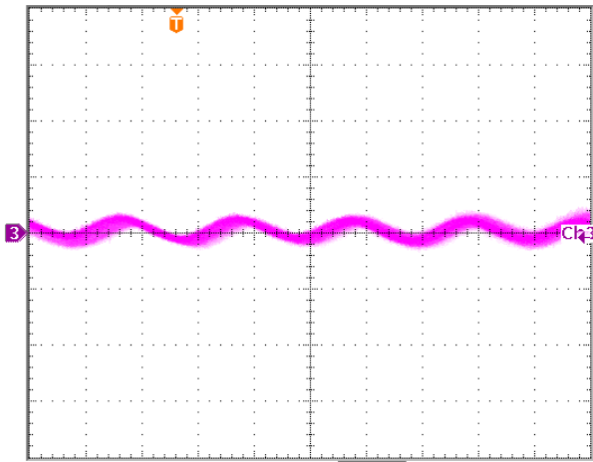

Figure 16: Input reflected ripple current, i_s , through a $12\mu\text{H}$ source inductor at nominal input voltage and rated load current (50 mA/div , $5\mu\text{s/div}$).

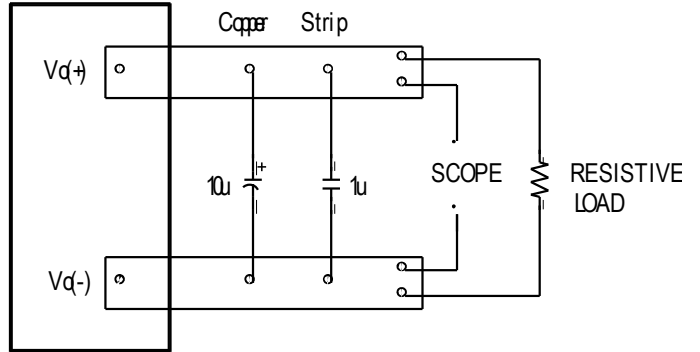

Figure 17: Output voltage noise and ripple measurement test setup

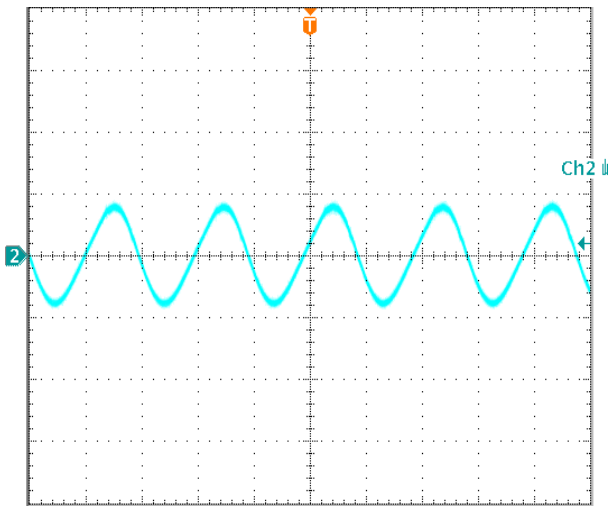

Figure 18: Output voltage ripple at nominal input voltage and rated load current (100 mV/div , $2\mu\text{s/div}$)
 Load capacitance: $1\mu\text{F}$ ceramic capacitor and $10\mu\text{F}$ tantalum capacitor. Bandwidth: 20 MHz . Scope measurements should be made using a BNC cable (length shorter than 20 inches). Position the load between 51 mm to 76 mm (2 inches to 3 inches) from the module.

DESIGN CONSIDERATIONS

Input Source Impedance

The impedance of the input source connecting to the DC/DC power modules will interact with the modules and affect the stability. A low ac-impedance input source is recommended. If the source inductance is more than a few μH , we advise adding a 100 to 200 μF electrolytic capacitor (ESR < 0.7 Ω at 100 kHz) mounted close to the input of the module to improve the stability.

Layout and EMC Considerations

Delta's DC/DC power modules are designed to operate in a wide variety of systems and applications. For design assistance with EMC compliance and related PWB layout issues, please contact Delta's technical support team. An external input filter module is available for easier EMC compliance design. Below is the reference design for an input filter tested with Q54SG120XXXXXX to meet class B in CISPR 22.

Schematic and Components List

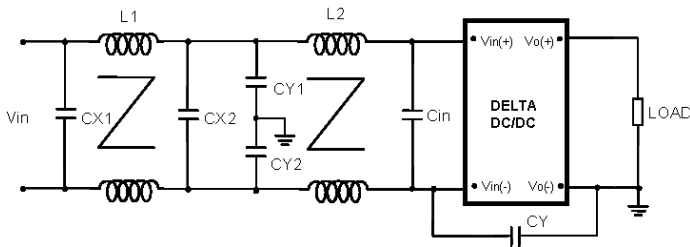

For Single Module Application

Cin is 100 μF low ESR Aluminum cap x3pcs in parallel;
CX1 is 2.2 μF ceramic cap x2pcs in parallel;
CX2 is 2.2 μF ceramic cap;
CY1 is 47nF ceramic cap x 2pcs in parallel;
CY2 is 47nF ceramic cap x 2pcs in parallel;
CY is 3.3nF ceramic cap;
L1 and L2 are common-mode inductors, L1=L2=0.33mH;

Test Result: Vin=54V, Io=50A

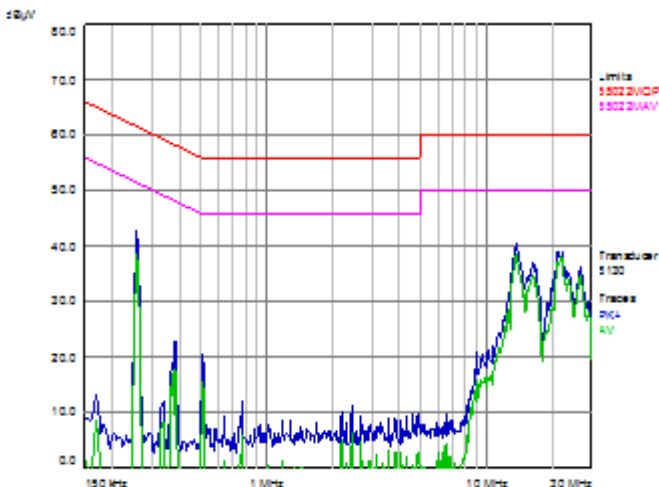

Safety Considerations

The power module must be installed in compliance with the spacing and separation requirements of the end-user's safety agency standard, i.e., UL60950-1, CSA C22.2 NO. 60950-1 2nd, IEC 60950-1 2nd : 2005, EN 60950-1 2nd: 2006+A11+A1: 2010, if the system in which the power module is to be used must meet safety agency requirements.

Basic insulation based on 75 Vdc input is provided between the input and output of the module for the purpose of applying insulation requirements when the input to this DC-to-DC converter is identified as TNV-2 or SELV. An additional evaluation is needed if the source is other than TNV-2 or SELV.

When the input source is SELV circuit, the power module meets SELV (safety extra-low voltage) requirements. If the input source is a hazardous voltage which is greater than 60 Vdc and less than or equal to 75 Vdc, for the module's output to meet SELV requirements, all of the following must be met:

- The input source must be insulated from the ac mains by reinforced or double insulation.
- The input terminals of the module are not operator accessible.
- A SELV reliability test is conducted on the system where the module is used, in combination with the module, to ensure that under a single fault, hazardous voltage does not appear at the module's output.

When installed into a Class II equipment (without grounding), spacing consideration should be given to the end-use installation, as the spacing between the module and mounting surface have not been evaluated.

The power module has extra-low voltage (ELV) outputs when all inputs are ELV.

This power module is not internally fused. To achieve optimum safety and system protection, an input line fuse is highly recommended. The safety agencies require a Fast-acting fuse with 30A maximum rating to be installed in the ungrounded lead. A lower rated fuse can be used based on the maximum inrush transient energy and maximum input current.

Soldering and Cleaning Considerations

Post solder cleaning is usually the final board assembly process before the board or system undergoes electrical testing. Inadequate cleaning and/or drying may lower the reliability of a power module and severely affect the finished circuit board assembly test. Adequate cleaning and/or drying is especially important for un-encapsulated and/or open frame type power modules. For assistance on appropriate soldering and cleaning procedures, please contact Delta's technical support team.

FEATURES DESCRIPTIONS

Over-Current Protection

The modules include an internal output over-current protection circuit. If the output current exceeds the OCP set point, the modules will shut down, and enter hiccup mode or latch mode. For hiccup mode, the module will try to restart after shutdown. If the overload condition still exists, the module will shut down again. This restart trial will continue until the overload condition is corrected. For latch mode, the module will shut down and not attempt to restart. The latch is reset by either cycling the input power or by toggling the primary on/off signal for one second. The OCP threshold and protection mode can be reconfigured by the PMBus Interface; the default configuration is hiccup mode.

Over-Voltage Protection

The modules include an internal output over-voltage protection circuit. If output voltage exceeds the over-voltage set point, the module will shut down, and enter in hiccup mode or latch mode. For hiccup mode, the module will try to restart after shutdown. If the output overvoltage condition still exists, the module will shut down again. This restart trial will continue until the over-voltage condition is corrected. For latch mode, the module will shut down and not attempt to restart. The latch is reset by either cycling the input power or by toggling the primary on/off signal for one second. The Vo OVP threshold and protection mode can be reconfigured by the PMBus Interface; the default configuration is hiccup mode.

Over-Temperature Protection

The modules include an internal over-temperature protection circuit. If the module temperature exceeds the over-temperature threshold the module will shut down, and enter in auto-recovery mode or latch mode. For auto-recovery mode, the module will monitor the module temperature after shutdown. Once the temperature is dropped and within the specification, the module will be auto-recovery. For latch mode, the module will shut down and not attempt to restart. The latch is reset by either cycling the input power or by toggling the primary on/off signal for one second. The OTP threshold and protection mode can be reconfigured by the PMBus Interface; the default configuration is hiccup mode.

Primary Remote On/Off

The primary remote on/off feature on the module can be either negative or positive logic. Negative logic turns the module on during a logic low and off during a logic high. Positive logic turns the modules on during a logic high and off during a logic low.

The primary remote on/off can be controlled by an external switch between the on/off terminal and the Vi(-) terminal. The switch can be an open collector or open drain. If the remote on/off feature is not used, for negative logic, please short the on/off pin to Vi(-); For positive logic, please leave the on/off pin floating. The module will not response to the remote on/off signal which is less than 120us. The primary remote on/off logic can be reconfigured by the PMBus Interface.

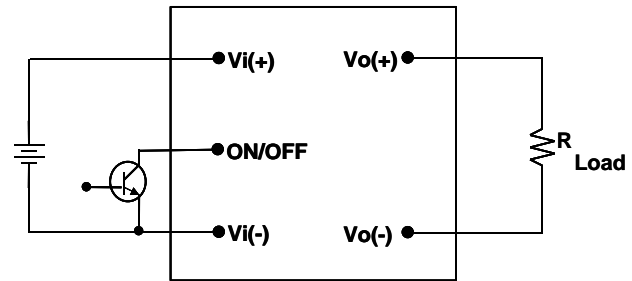

Figure 19: Remote on/off implementation

Secondary Remote On/Off

Reference to the Vo(-) terminal, there is a C2 pin. The default configuration is set to ignore this input. And such pin can be reconfigured as secondary remote on/off pin by the PMBus interface including either negative or positive logic. Negative logic turns the module on during a logic low and off during a logic high. Positive logic turns the modules on during a logic high and off during a logic low. The secondary remote on/off can be controlled by an external switch between the on/off terminal and the Vo(-) terminal. The switch can be an open collector or open drain.

PMBus Communication

The module has a digital PMBus interface to allow the module to be monitored, controlled and configured by the system. The module supports 4 PMBus signal lines, Data, Clock, SMBALERT (optional), Control (C2 pin, optional), and 2 Address line Addr0 and Addr1. More detail PMBus information can be found in the PMB Power Management Protocol Specification, Part I and part II, revision 1.2; which is shown in <http://pmbus.org>. Both 100kHz and 400kHz bus speeds are supported by the module. Connection for the PMBus interface should be following the High Power DC specifications given in section 3.1.3 in the SMBus specification V2.0 or the Low Power DC specifications in section 3.1.2. The complete SMBus specification is shown in <http://smbus.org>.

FEATURES DESCRIPTIONS (CON.)

The module supports the Packet Error Checking (PEC) protocol. It can check the PEC byte provided by the PMBus master, and include a PEC byte in all message responses to the master.

SMBALERT protocol is also supported by the module. SMBALERT line is also a wired-AND signal; by which the module can alert the PMBUS master via pulling the SMBALERT pin to an active low. There are two ways that the master and the module response to the alert of SMBALERT line.

One way is for the module used in a system that does not support Alert Response Address (ARA). The module is to retain its resistor programmed address, when it is in an ALERT active condition. The master will communicate with the slave module using the programmed address, and using the various READ_STATUS commands to find who cause for the SMBALERT. The CLEAR_FAULTS command will clear the SMBALERT.

The other way is for the module used in a system that does support Alert Response Address (ARA). In this case, the master simultaneously accesses all SMBALERT devices through the ARA. Only the device which pulled SMBALERT low will acknowledge the ARA. The master is expected to perform the modified received byte operation to get the address of the alert slave, and retire the SMBALERT active signal. And then, the alert slave will return to its resistor programmed address, allowing normal master-slave communications to proceed.

If more than one slave pulls SMBALERT line low, the lowest address slave will win communication rights via standard arbitration during the slave address transfer. After acknowledging the ARA, the lowest address slave must disengage its SMBALERT pull down. If the master still sees SMBALERT line low, it knows to send another ARA and ask again "Now, who is holding the alert down". The second slave is now locked-up and can't responsive. But the solution is easy; the master should now initiate a "dummy command", for example read command on the bus and read any parameter from any slave. After this, the second slave (the one that lost arbitration in the first run) will be released. Now, if master sends the second ARA, the second slave will provide its address to the Master.

The module contains a data flash used to store configuration settings, which will not be programmed into the device data flash automatically. The STORE_DEFAULT_ALL command must be used to commit the current settings are transfer from RAM to data flash as device defaults.

PMBUS Addressing

The Module has flexible PMBUS addressing capability. When connect different resistor from Addr0 and Addr1 pin to GND pin, 64 possible addresses can be acquired. The address is in the form of octal digits; Each pin offer one octal digit, and then combine together to form the decimal address as shown in below.

$$\text{Address} = 8 * \text{ADDR1} + \text{ADDR0}$$

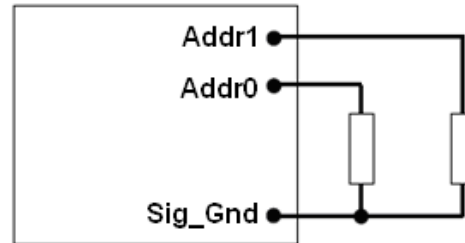

Corresponded to each octal digit, the requested resistor values are shown in below, and +/-5% resistors accuracy can be accepted. If there is any resistances exceeding the requested range, address 127 will be return. 0-12 and 40, 44, 45, and 55 in decimal address can't be used, since they are reserved according to the SMBus specifications, and which will also return address 127.

Octal digit	Resistor(Kohm)
0	10
1	15.4
2	23.7
3	36.5
4	54.9
5	84.5
6	130
7	200

FEATURES DESCRIPTIONS (CON.)

PMBus Data Format

The module receives and report date in LINEAR format. The Exponent of the data words is fixed at a reasonable value for the command; altering the exponent is not supported. DIRECT format is not supported by the module.

For commands that set or report any voltage thresholds related to the output voltage, the module supports the linear data format consisting of a two byte value with a 16-bit, unsigned mantissa, and a fixed exponent of -12. The format of the two data bytes is shown below:

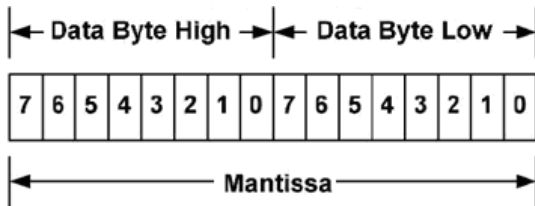

The equation can be written as:

$$V_{out} = \text{Mantissa} \times 2^{-12}$$

For example, considering set V_{out} to 12V by VOUT_COMMAND, the read/write data can be calculated refer to below process:

1. $\text{Mantissa} = V_{out} / 2^{-12} = 12 / 2^{-12} = 49152$;
2. Converter the calculated Mantissa to hexadecimal 0xC000.

For commands that set or report all other thresholds, including input voltages, output current, temperature, time and frequency, the supported linear data format is a two byte value with: an 11 bit, two's complement mantissa, and a 5 bit, two's complement exponent (scaling factor). The format of the two data bytes is shown as in below.

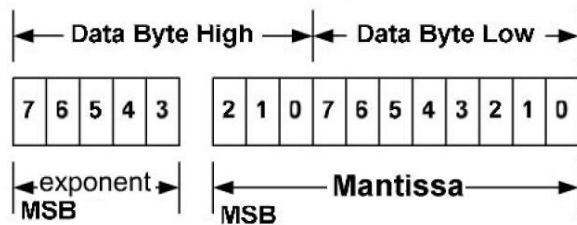

The equation can be written as:

$$\text{Value} = \text{Mantissa} \times 2^{\text{exponent}}$$

For example, considering set the turn on threshold of input under voltage lockout to 34V by VIN_ON command; the read/write data can be calculated refer to below process:

1. Get the exponent of V_{in} , -3; whose binary is 11101
2. $\text{Mantissa} = V_{in} / 2^{-3} = 34 / 2^{-3} = 272$;
3. Converter the calculated Mantissa to hexadecimal 110, then converter to binary 00100010000;
4. Combine the exponent and the mantissa, 11101

The detail exponent and resolution of main parameter is summarized as below:

	Exponent	Resolution
V_{in}	-3	0.125V
V_o	-12	0.244mV
I_o	-4	62.5mA
Temperature	-2	/
Switching requency	-2	0.25Khz
Time	-1	0.5ms

Supported PMBus Commands

The main PMBus commands described in the PMBus 1.2 specification are supported by the module. Partial PMBus commands are fully supported; Partial PMBus commands have difference with the definition in PMBus 1.2 specification. All the supported PMBus commands are detail summarized in below table.

FEATURES DESCRIPTIONS (CON.)

Command	Command Code	Command description	Transfer type	Compatible with standard PMBUS or not?	Data Format	Default value	Range limit	Data units	Exponent	Note
OPERATION	0x01	Turn the module on or off by PMBUS command	R/W byte	Refer to below description;	Bit field	0x80	/	/	/	/
ON_OFF_CONFIG	0x02	Configures the combination of primary on/off pin and PMBUS command	R/W byte	Refer to below description;	Bit field	0x1D (Neg Logic); 0x1F (Pos Logic);	/	/	/	/
CLEAR_FAULTS	0x03	Clear any fault bits that have been set	Send byte	Yes	/	/	/	/	/	/
STORE_DEFAULT_ALL	0x11	Stores operating parameters from RAM to data flash	Send byte	Yes	/	/	/	/	/	This command is effective to the parameter of all command in the table.
RESTORE_DEFAULT_ALL	0x12	Restores operating parameters from data flash to RAM	Send byte	Yes	/	/	/	/	/	This command can't be issued when the power unit is running.
VOUT_MODE	0x20	To read Vo data format	Read byte	Yes	mode+exp	0x14	/	/	/	/
VOUT_COMMAND	0x21	Set the output voltage	R/W word	Yes	Vout Linear	12	9.6 ~13.2	Volts	-12	/
FREQUENCY_SWITCH	0x33	Set the switching frequency	R/W word	Yes	Frequency Linear	130	120 ~140	KHz	-2	Need be changed after module turn off
VOUT_OV_FAULT_LIMIT	0x40	Set the output overvoltage fault threshold.	R/W word	Yes	Vout Linear	15	11~16	V	-12	Must be higher than the value of VOUT_COMMAND and VOUT_OV_WARN_LIMIT;

Command	Command Code	Command description	Transfer type	Compatible with standard PMBUS or not?	Data Format	Default value	Range limit	Data units	Exponent	Note
VOUT_OV_FAULT_RESPONSE	0x41	Instructs what action to take in response to an output overvoltage fault.	R/W byte	Refer to below description;	Bit field	0xB8	/	N/A	/	/
VOUT_OV_WARN_LIMIT	0x42	Set a threshold causing an output voltage high warning.	R/W word	Yes	Vout Linear	15	11-16	V	-12	Must be less than VOUT_OV_FAULT_LIMIT value
IOUT_OC_FAULT_LIMIT	0x46	Set the output overcurrent fault threshold.	R/W word	Yes	Iout Linear	60	50-80	A	-4	Must be greater than IOUT_OC_WARN_LIMIT value
IOUT_OC_FAULT_RESPONSE	0x47	Instructs what action to take in response to an output overcurrent fault.	R/W byte	Refer to below description;	Bit field	0xF8	/	N/A	/	/
IOUT_OC_WARN_LIMIT	0x4A	Set a threshold causing an output current high warning.	R/W word	Yes	Iout Linear		50-80	A	-4	Must be less than IOUT_OC_FAULT_LIMIT value
OT_FAULT_LIMIT	0x4F	Set the over temperature fault threshold.	R/W word	Yes	TEMP Linear	125	25-140	Deg. C	-2	Must be greater than OT_WARN_LIMIT value
OT_FAULT_RESPONSE	0x50	Instructs what action to take in response to an over temperature fault.	R/W byte	Refer to below description;	Bit field	0xB8	/	N/A	/	/
OT_WARN_LIMIT	0x51	Set a threshold causing a temperature high warning.	R/W word	Yes	TEMP Linear	115	25-125	Deg. C	-2	Must be less than OT_FAULT_LIMIT value
VIN_OV_FAULT_LIMIT	0x55	Set the input overvoltage fault threshold.	R/W word	Yes	Vin Linear	110	48-110	V	-3	/
POWER_GOOD_ON	0x5E	Sets the output voltage at which the bit 3 of STATUS_WORD high byte should be asserted.	R/W word	Yes	Vout Linear	11	8.1-13.2	V	-12	Must be greater than POWER_GOOD_OFF value by 1.6V
POWER_GOOD_OFF	0x5F	Sets the output voltage at which the bit 3 of STATUS_WORD high byte should be negated.	R/W word	Yes	Vout Linear	9	8.1-13.2	V	-12	Must be less than POWER_GOOD_ON value by 1.6V
TON_DELAY	0x60	Sets the time from a start condition is received until the output voltage starts to rise	R/W word	Yes	Time Linear		5-500	ms	-1	/

Command	Command Code	Command description	Transfer type	Compatible with standard PMBUS or not?	Data Format	Default value	Range limit	Data units	Exponent	Note
TON_RISE	0x61	Sets the time from the output starts to rise until the voltage has entered the regulation band.	R/W word	Yes	Time Linear		15-500	ms	-1	/
STATUS_WORD	0x79	Returns the information with a summary of the module's fault/warning	Read word	Refer to below description;	Bit field	/	/	/	/	/
STATUS_VOUT	0x7A	Returns the information of the module's output voltage related fault/warning	Read byte	Refer to below description;	Bit field	/	/	/	/	/
STATUS_IOUT	0x7B	Returns the information of the module's output current related fault/warning	Read byte	Refer to below description;	Bit field	/	/	/	/	/
STATUS_INPUT	0x7C	Returns the information of the module's input over voltage and under voltage fault	Read byte	Refer to below description;	Bit field	/	/	/	/	/
STATUS_TEMPERATURE	0x7D	Returns the information of the module's temperature related fault/warning	Read byte	Refer to below description;	Bit field	/	/	/	/	/
STATUS_CML	0x7E	Returns the information of the module's communication related faults.	Read byte	Refer to below description;	Bit field	/	/	/	/	/
READ_VIN	0x88	Returns the input voltage of the module	Read word	Yes	Vin Linear	/	/	Volts	/	/
READ_VOUT	0x8B	Returns the output voltage of the module	Read word	Yes	Vout Linear	/	/	Volts	/	/
READ_IOUT	0x8C	Returns the output current of the module	Read word	Yes	Iout Linear	/	/	Amps	/	/
READ_TEMPERATURE_1	0x8D	Returns the module's hot spot temperature of the module	Read word	Yes	TEMP Linear	/	/	Deg. C	/	/
PMBUS_REVISION	0x98	Reads the revision of the PMBus	Read byte	Yes	Bit field	1.2	/	/	/	/



Command	Command Code	Command description	Transfer type	Compatible with standard PMBUS or not?	Data Format	Default value	Range limit	Data units	Exponent	Note
MFR_C2_Configure	0xE1	Configures the C2 pin (secondary on/off pin) function and logic;	R/W byte	Refer to below description;	Bit field	0x00	/	/	/	/

FEATURES DESCRIPTIONS (CON.)

OPERATION [0x01]

Bit number	Purpose	Bit Value	Meaning	Default Settings, 0x80
7:	Enable/Disable the module	1	Output is enabled	1
		0	Output is disabled	
6:0	Reserved			0000000

ON_OFF_CONFIG [0x02]

Bit number	Purpose	Bit Value	Meaning	Default Settings, 0x1D (negative) /0x1F (positive)
7:5	Reserved			000
4	Controls how the unit responds to the primary on/off pin and the OPERATION command;	1	Module does not power up until commanded by the primary ON/OFF pin and the OPERATION	1
		0	Module power up at any time regardless of the state of the primary ON/OFF pin and the OPERATION	
3	Controls how the unit responds to the OPERATION command	1	Module responds to the 7 bit in the OPERATION	1
		0	Module ignores the 7 bit in the OPERATION	
2	Controls how the unit responds to the primary on/off pin	1	Module requires the primary ON/OFF pin to be asserted to start the unit	1
		0	Module ignores the state of the primary ON/OFF pin	
1	Control logic of primay on/off pin	1	Positive Logic	0, negative; 1, positive.
		0	Negative Logic	
0	Unit turn off delay time control	1	Shut down the module with 0 delay cycle	1

VOUT_OV_FAULT_RESPONSE [0x41]

Bit number	Purpose	Bit Value	Meaning	Default Settings, 0xB8
7:6	Response settings	10	Unit shuts down and responds according to the retry settings	10
5:3	Retry setting	111	Unit continuously restarts while fault is present until commanded off	111
		000	Unit does not attempt to restart on fault	
2:0	Delay time setting	000	No delay supported	000

IOUT_OC_FAULT_RESPONSE [0x47]

Bit number	Purpose	Bit Value	Meaning	Default Settings, 0xF8
7:6	Response settings	11	Unit shuts down and responds according to the retry settings	11,
5:3	Retry settings	111	Unit continuously restarts while fault is present until commanded off	111
		000	Unit does not attempt to restart on fault	
2:0	Delay time setting	000	No delay supported	000

FEATURES DESCRIPTIONS (CON.)

OT_FAULT_RESPONSE [0x50]

Bit number	Purpose	Bit Value	Meaning	Default Settings, 0xB8
7:6	Response settings	10	Unit shuts down and responds according to the retry settings	10,
5:3	Retry settings	111	Unit continuously restarts while fault is present until commanded off	111
		000	Unit does not attempt to restart on fault	
2:0	Delay time setting	000	No delay supported	000

STATUS_WORD [0x79]

High byte

Bit number	Purpose	Bit Value	Meaning
7	An output over voltage fault or warning	1	Occurred
		0	No Occurred
6	An output over current fault or warning	1	Occurred
		0	No Occurred
5	An input voltage fault, including over voltage and undervoltage	1	Occurred
		0	No Occurred
4	Reserved		
3	Power_Good	1	is negated
		0	ok
2:0	Reserved		

Low byte

Bit number	Purpose	Bit Value	Meaning
7	Reserved		
6	OFF (The unit is not providing power to the output, regardless of the reason)	1	Occurred
		0	No Occurred
5	An output over voltage fault	1	Occurred
		0	No Occurred
4	An output over current fault	1	Occurred
		0	No Occurred
3	An input under voltage fault	1	Occurred
		0	No Occurred
2	A temperature fault or warning	1	Occurred
		0	No Occurred
1	CML (A communications, memory or logic fault)	1	Occurred;
		0	No Occurred
0	Reserved		

FEATURES DESCRIPTIONS (CON.)

STATUS_VOUT [0x7A]

Bit number	Purpose	Bit Value	Meaning
7	Output over voltage fault	1	Occurred;
		0	No Occurred
6	Output over voltage warning	1	Occurred;
		0	No Occurred
5:0	Reserved		

STATUS_IOUT [0x7B]

Bit number	Purpose	Bit Value	Meaning
7	Output over current fault	1	Occurred;
		0	No Occurred
6	Reserved		
5	Output over current warning	1	Occurred;
		0	No Occurred
4:0	Reserved		

STATUS_INPUT [0x7C]

Bit number	Purpose	Bit Value	Meaning
7	Input over voltage fault	1	Occurred;
		0	No Occurred
6: 5	Reserved		
4	Input under voltage fault	1	Occurred;
		0	No Occurred
3:0	Reserved		

STATUS_TEMPERATURE [0x7D]

Bit number	Purpose	Bit Value	Meaning
7	Over temperature fault	1	Occurred;
		0	No Occurred
6	Over temperature warning	1	Occurred;
		0	No Occurred
5:0	Reserved		

FEATURES DESCRIPTIONS (CON.)

STATUS_CML [0x7E]

Bit number	Purpose	Bit Value	Meaning
7	Invalid/Unsupported Command Received	1	Occurred;
		0	No Occurred
6	Invalid/Unsupported Data Received	1	Occurred;
		0	No Occurred
5	Packet Error Check Failed	1	Occurred;
		0	No Occurred
4:0	Reserved		

MFR_C2_Configure [0xE1]

Bit number	Purpose	Bit Value	Meaning	Default Settings, 0x00
7:2	Reserved			000000
1	Secondary ON/OFF Configuration	1	AND – Primary and Secondary side on/off	0
		0	C2 is ignored	
0	Secondary side on/off Logic	1	Positive Logic	0
		0	Negative Logic	

FEATURES DESCRIPTIONS (CON.)

Output Voltage Adjustment (TRIM)

To increase or decrease the output voltage set point, connect an external resistor between the TRIM pin and either the Vo(+) or Vo(-). The TRIM pin should be left open if this feature is not used. Below Trim equation is only adapt to the module without droop current sharing option code; For the module with droop current sharing option code, please contact Delta's technical support team.

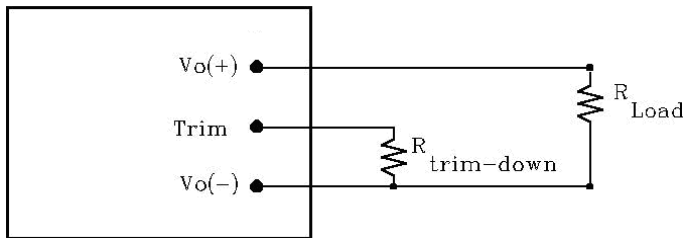

Figure 20: Circuit configuration for trim-down (decrease output voltage)

If the external resistor is connected between the TRIM and Vo (-) pins, the output voltage set point decreases (Fig. 19). The external resistor value required to obtain a percentage of output voltage change $\Delta\%$ is defined as:

$$R_{trim-down} = \left[\frac{511}{\Delta} - 10.2 \right] (K\Omega)$$

Ex. When Trim-down -10% ($12V \times 0.9 = 10.8V$)

$$R_{trim-down} = \left[\frac{511}{10} - 10.2 \right] (K\Omega) = 40.9(K\Omega)$$

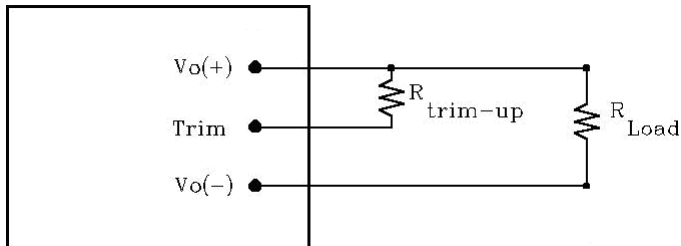

Figure 21: Circuit configuration for trim-up (increase output voltage)

If the external resistor is connected between the TRIM and Vo (+) the output voltage set point increases (Fig. 20). The external resistor value required to obtain a percentage output voltage change $\Delta\%$ is defined as:

$$R_{trim-up} = \frac{5.11V_o(100+\Delta)}{1.225\Delta} - \frac{511}{\Delta} - 10.2(K\Omega)$$

Ex. When Trim-up +10% ($12V \times 1.1 = 13.2V$)

$$R_{trim-up} = \frac{5.11 \times 12 \times (100 + 10)}{1.225 \times 10} - \frac{511}{10} - 10.2 = 489.3(K\Omega)$$

Care should be taken to ensure that the maximum output power of the module remains at or below the maximum rated power.

Parallel and Droop Current Sharing

The module has voltage droop function is capable of parallel operation. There is a 250mV output voltage droop when output current varies from 0A to full load current, so the maximum $\pm 25mV$ set point variation will guarantee the current sharing accuracy at room temperature within 10%. By connecting the Vin pin and the Vo pin of the parallel module together, the current sharing can be realized automatically.

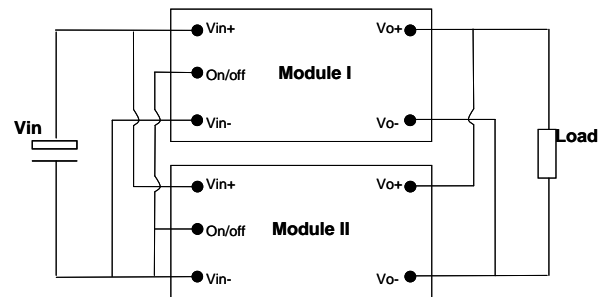

Figure 21: Parallel and droop current sharing configuration for no redundancy requirement system

If system has no redundancy requirement, the module can be parallel directly without adding external oring-fet; whereas, if the redundancy function is required, external oring-fets are needed.

To ensure normal parallel operation, the following precautions must be observed:

1. The current sharing accuracy equation is:

$X\% = |I_o - (I_{total} / N)| / I_{rated}$, Where,
 I_o is the output current of each module;
 I_{total} is the total load current;
 N is parallel module numbers;
 I_{rated} is the rated full load current of per module.

2. To ensure a better current sharing accuracy, below design guidelines should be followed:

- The inputs of the converters must be connected to the same voltage source; and the PCB trace resistance from Input voltage source to Vin+ and Vin- of each converter should be equalized as much as possible.
- The PCB trace resistance from each converter's output to the load should be equalized as much as possible.
- For accurate current sharing accuracy test, the module should be soldered in order to avoid the unbalance of the contact resistance between the modules to the test board.

FEATURES DESCRIPTIONS (CON.)

3. To ensure the parallel module can start up monotonically without triggering the OCP, below design guideline should be followed:

a) Before all the parallel modules finish start up, the total load current should be lower than the rated current of a single module.

b) The ON/OFF pin of the converters should be connected together to keep the parallel modules start up at the same time.

c) Since the input under voltage lockout set point varies slightly from module to module, the dv/dt of the rising edge of the input source voltage must be greater than 1V/ms to ensure the parallel modules start up at the same time.

THERMAL CONSIDERATIONS

Thermal management is an important part of the system design. To ensure proper, reliable operation, sufficient cooling of the power module is needed over the entire temperature range of the module. Convection cooling is usually the dominant mode of heat transfer.

Hence, the choice of equipment to characterize the thermal performance of the power module is a wind tunnel.

Thermal Testing Setup

Delta's DC/DC power modules are characterized in heated vertical wind tunnels that simulate the thermal environments encountered in most electronics equipment. This type of equipment commonly uses vertically mounted circuit cards in cabinet racks in which the power modules are mounted.

The following figure shows the wind tunnel characterization setup. The power module is mounted on a 185mmX185mm,70 μ m (2Oz),6 layers test board and is vertically positioned within the wind tunnel. The space between the neighboring PWB and the top of the power module is constantly kept at 6.35mm (0.25").

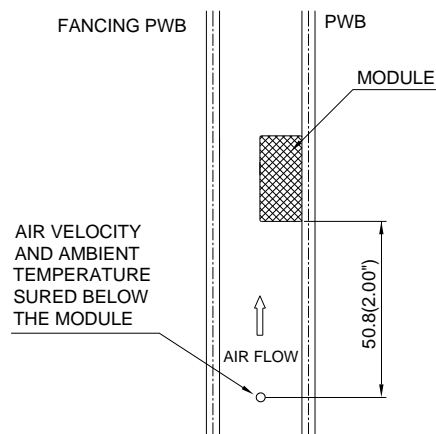

Note: Wind Tunnel Test Setup Figure Dimensions are in millimeters and (Inches)

Figure 22: Wind tunnel test setup

Thermal Derating

Heat can be removed by increasing airflow over the module. To enhance system reliability; the power module should always be operated below the maximum operating temperature. If the temperature exceeds the maximum module temperature, reliability of the unit may be affected.

THERMAL CURVES (WITH HEAT SPREADER)

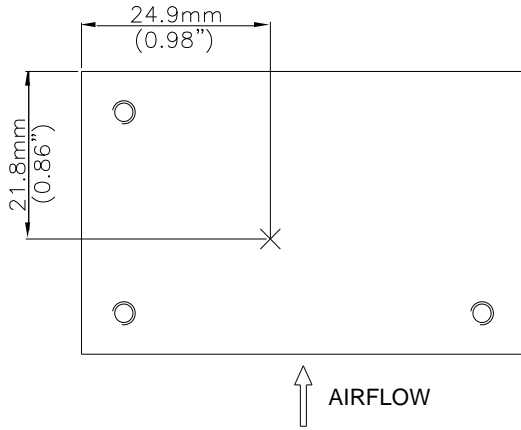

Figure 23: * Hot spot 1 temperature measured point. the allowed maximum hot spot temperature is defined at 102 °C

THERMAL CURVES (WITH 0.5" HEIGHT HEAT SINK)

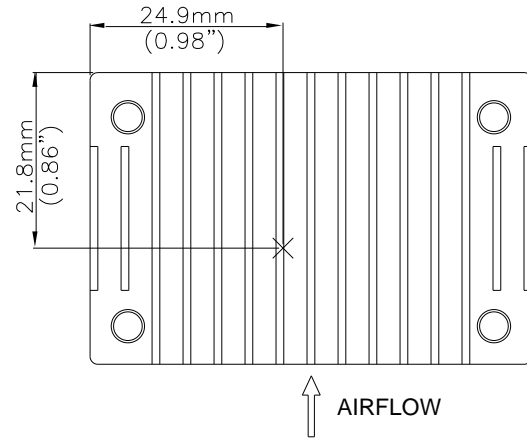

Figure 24: * Hot spot 2 temperature measured point. the allowed maximum hot spot temperature is defined at 90 °C

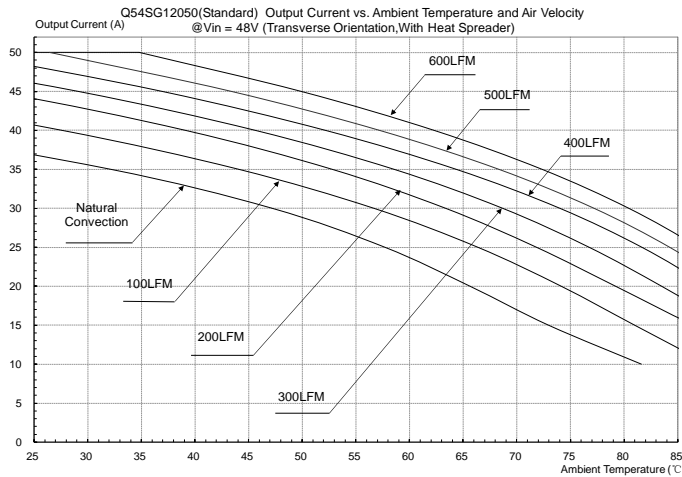

Figure 25 Output power vs. ambient temperature and air velocity @Vin=48V(Transverse Orientation, airflow from Vin- to Vin+, with heat spreader)

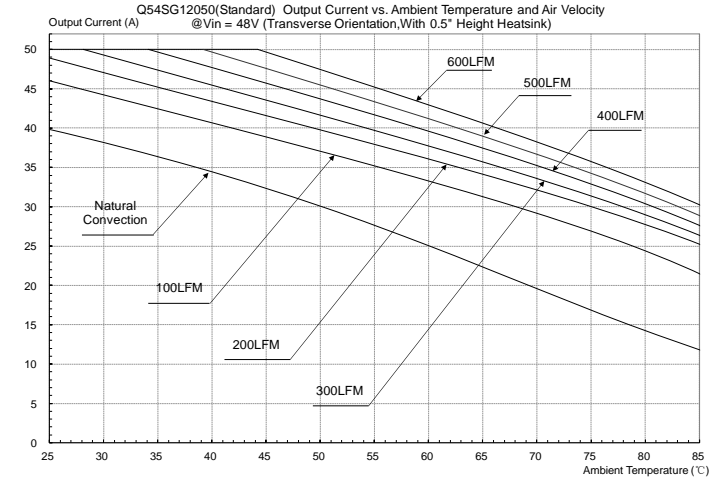

Figure 26: Output power vs. ambient temperature and air velocity @Vin=48V(Transverse Orientation, airflow from Vin- to Vin+, with 0.5" height heat sink)

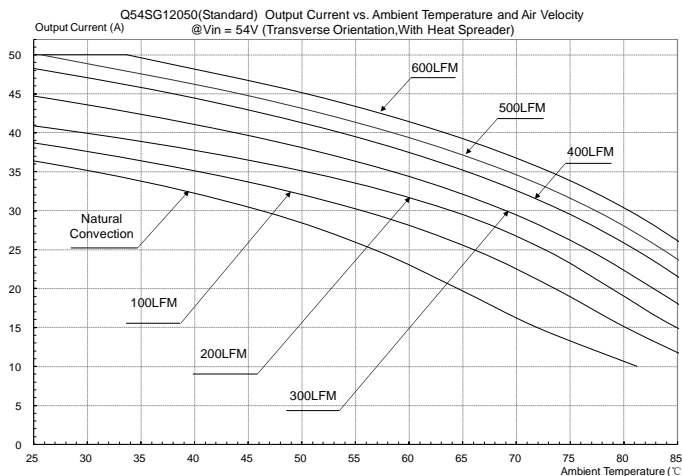

Figure 27: Output power vs. ambient temperature and air velocity @Vin=54V(Transverse Orientation, airflow from Vin- to Vin+, with heat spreader)

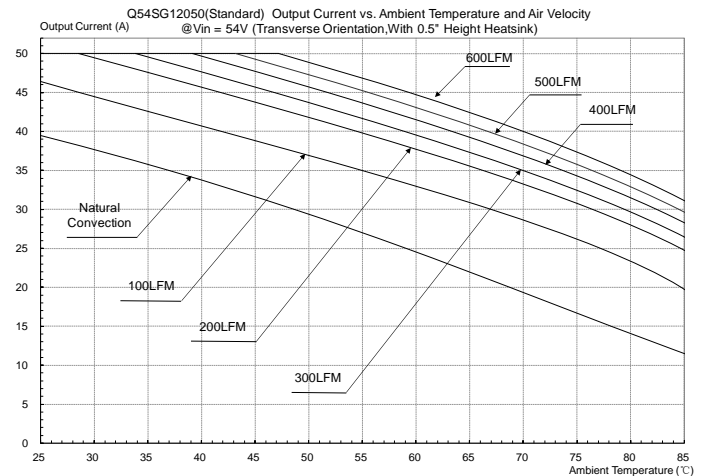
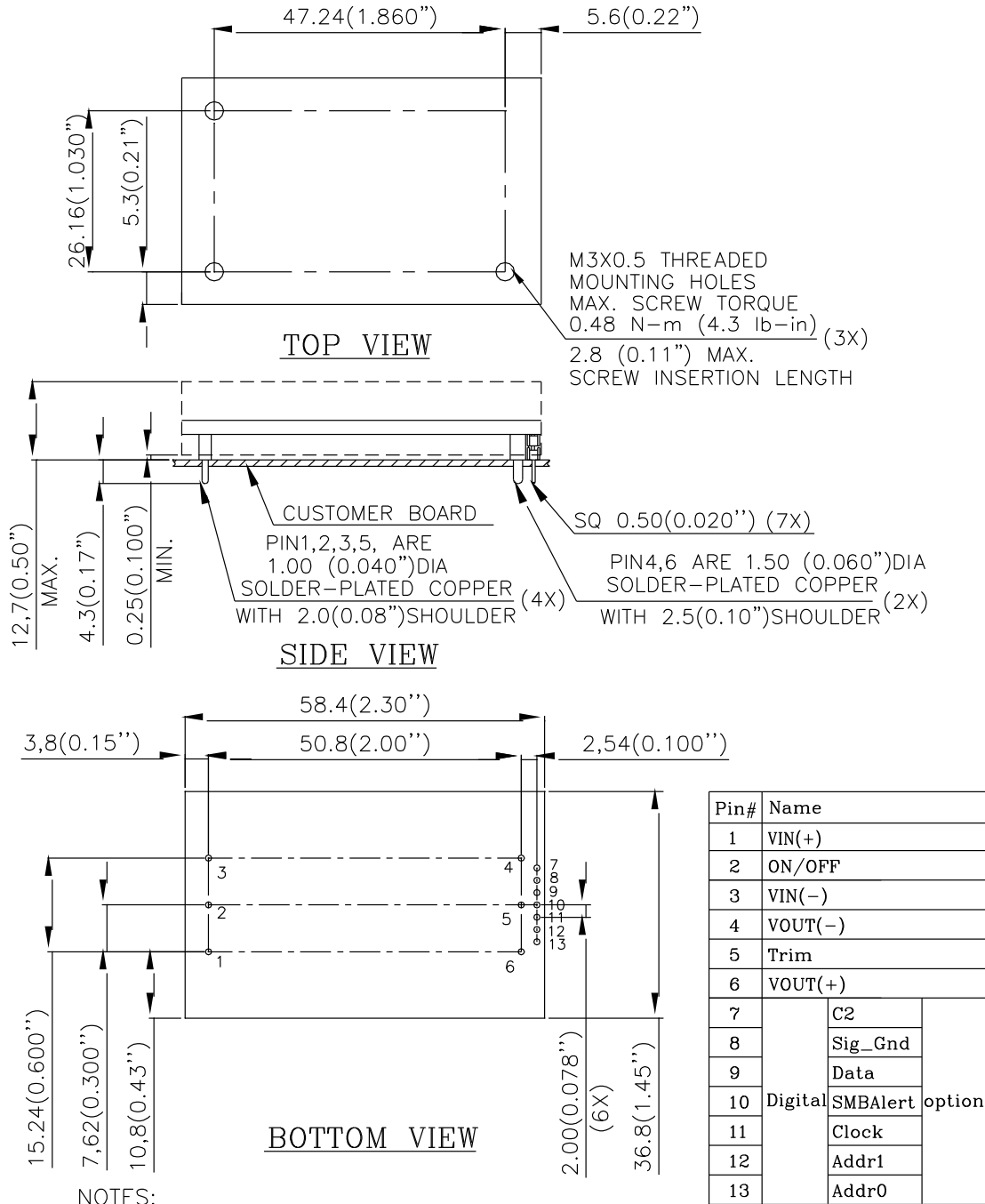

Figure 28: Output power vs. ambient temperature and air velocity @Vin=54V(Transverse Orientation, airflow from Vin- to Vin+, with 0.5" height heat sink)

MECHANICAL DRAWING (WITH HEAT SPREADER)

**For modules with through-hole pins and the optional heat spreader, they are intended for wave soldering assembly onto system boards, please do not subject such modules through reflow temperature profile.*



NOTES:
DIMENSIONS ARE IN MILLIMETERS AND (INCHES)
TOLERANCES: X.Xmm±0.5mm(X.XX in.±0.02 in.)
X.XXmm±0.25mm(X.XXX in.±0.010 in.)

Pin Specification:

Pins 1-3&5 1.00mm (0.040") diameter (All pins are copper with matte Tin plating over Nickel under plating)
Pins 4 & 6 1.50mm (0.059") diameter (All pins are copper with matte Tin plating over Nickel under plating)
Pins 7-13 SQ 0.50mm(0.020") (All pins are copper with gold flash plating)

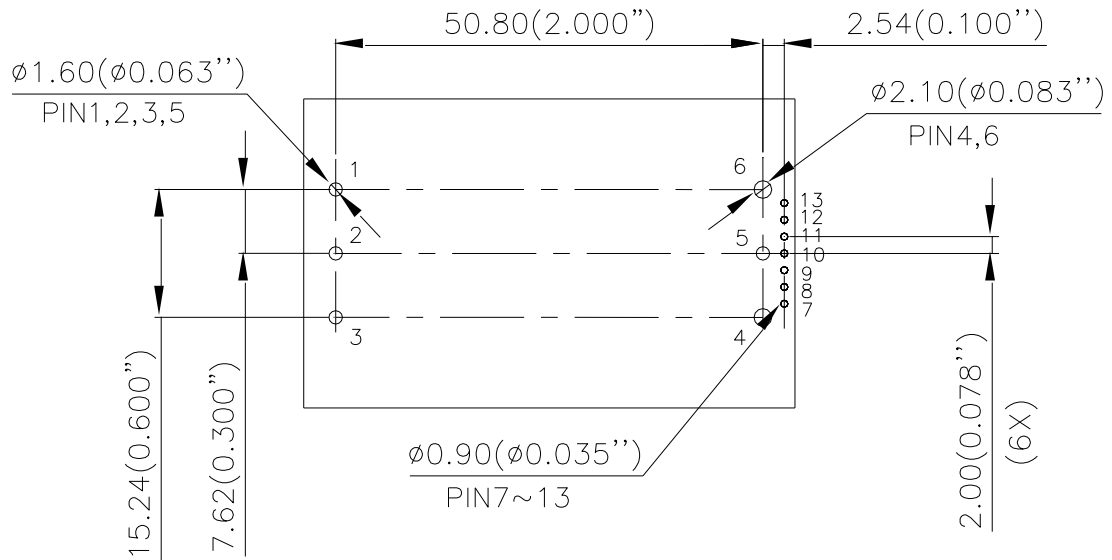

RECOMMENDED PWB LAYOUT

NOTES:

DIMENSIONS ARE IN MILLIMETERS AND (INCHES)

TOLERANCES: X.Xmm±0.5mm(X.XX in.±0.02 in.)

X.XXmm±0.25mm(X.XXX in.±0.010 in.)

PART NUMBERING SYSTEM

Q	54	S	G	120	50	N	R	F	G				
Type of Product	Input Voltage	Number of Outputs	Product Series	Output Voltage	Output Current	ON/OFF Logic	Pin Length /Type		Option Code				
Q - Quarter Brick	54 - 40~60V	S - Single	G - Full digital control	120 - 12V	50 - 50A	N - Negative P - Positive	K - 0.11" N - 0.145" R - 0.17" Y - 0.20"	F- RoHS 6/6 (Lead Free)		Droop Current Sharing	Trim Pin	PMBus pin	Heat spreader
									C	NO	Yes	No	Yes
									G	No	Yes	Yes	Yes
J	Yes	Yes	Yes	Yes									

MODEL LIST

MODEL NAME	INPUT		OUTPUT		EFF @ 100% LOAD
Q54SG12050NRFG	40V~60V	17A	12V	50A	96%
Q54SG12050NYFC	40V~60V	17A	12V	50A	96%
Q54SG12050NRFJ	40V~60V	17A	11.875V	50A	95.8%

Default remote on/off logic is negative and pin length is 0.170"

For different remote on/off logic and pin length, please refer to part numbering system above or contact your local sales office.

CONTACT: www.deltaww.com/dcdc

Email: dcdc@deltaww.com

USA:

Telephone:
East Coast: 978-656-3993
West Coast: 510-668-5100
Fax: (978) 656 3964

Europe:

Telephone: +31-20-655-0967
Fax: +31-20-655-0999

Asia & the rest of world:

Telephone: +886 3 4526107 x 6220~6224
Fax: +886 3 4513485

WARRANTY

Delta offers a two (2) year limited warranty. Complete warranty information is listed on our web site or is available upon request from Delta.

Information furnished by Delta is believed to be accurate and reliable. However, no responsibility is assumed by Delta for its use, nor for any infringements of patents or other rights of third parties, which may result from its use. No license is granted by implication or otherwise under any patent or patent rights of Delta. Delta reserves the right to revise these specifications at any time, without notice.

Компания «Океан Электроники» предлагает заключение долгосрочных отношений при поставках импортных электронных компонентов на взаимовыгодных условиях!

Наши преимущества:

- Поставка оригинальных импортных электронных компонентов напрямую с производств Америки, Европы и Азии, а так же с крупнейших складов мира;
- Широкая линейка поставок активных и пассивных импортных электронных компонентов (более 30 млн. наименований);
- Поставка сложных, дефицитных, либо снятых с производства позиций;
- Оперативные сроки поставки под заказ (от 5 рабочих дней);
- Экспресс доставка в любую точку России;
- Помощь Конструкторского Отдела и консультации квалифицированных инженеров;
- Техническая поддержка проекта, помощь в подборе аналогов, поставка прототипов;
- Поставка электронных компонентов под контролем ВП;
- Система менеджмента качества сертифицирована по Международному стандарту ISO 9001;
- При необходимости вся продукция военного и аэрокосмического назначения проходит испытания и сертификацию в лаборатории (по согласованию с заказчиком);
- Поставка специализированных компонентов военного и аэрокосмического уровня качества (Xilinx, Altera, Analog Devices, Intersil, Interpoint, Microsemi, Actel, Aeroflex, Peregrine, VPT, Syfer, Eurofarad, Texas Instruments, MS Kennedy, Miteq, Cobham, E2V, MA-COM, Hittite, Mini-Circuits, General Dynamics и др.);

Компания «Океан Электроники» является официальным дистрибьютором и эксклюзивным представителем в России одного из крупнейших производителей разъемов военного и аэрокосмического назначения «JONHON», а так же официальным дистрибьютором и эксклюзивным представителем в России производителя высокотехнологичных и надежных решений для передачи СВЧ сигналов «FORSTAR».



JONHON

«JONHON» (основан в 1970 г.)

Разъемы специального, военного и аэрокосмического назначения:

(Применяются в военной, авиационной, аэрокосмической, морской, железнодорожной, горно- и нефтедобывающей отраслях промышленности)

«FORSTAR» (основан в 1998 г.)

ВЧ соединители, коаксиальные кабели,
кабельные сборки и микроволновые компоненты:

(Применяются в телекоммуникациях гражданского и специального назначения, в средствах связи, РЛС, а так же военной, авиационной и аэрокосмической отраслях промышленности).



Телефон: 8 (812) 309-75-97 (многоканальный)

Факс: 8 (812) 320-03-32

Электронная почта: ocean@oceanchips.ru

Web: <http://oceanchips.ru/>

Адрес: 198099, г. Санкт-Петербург, ул. Калинина, д. 2, корп. 4, лит. А