

HSMW-C170

High Performance ChipLED

Data Sheet



Feature

- LED with InGaN material
- Small size
- Industrial standard footprint
- Diffused optics
- Compatible with reflow soldering
- Available in 8mm tape on 7" diameter reel

Application

- LCD backlighting
- Push button backlighting
- Front panel indicator
- Symbol indicator

Package Dimension

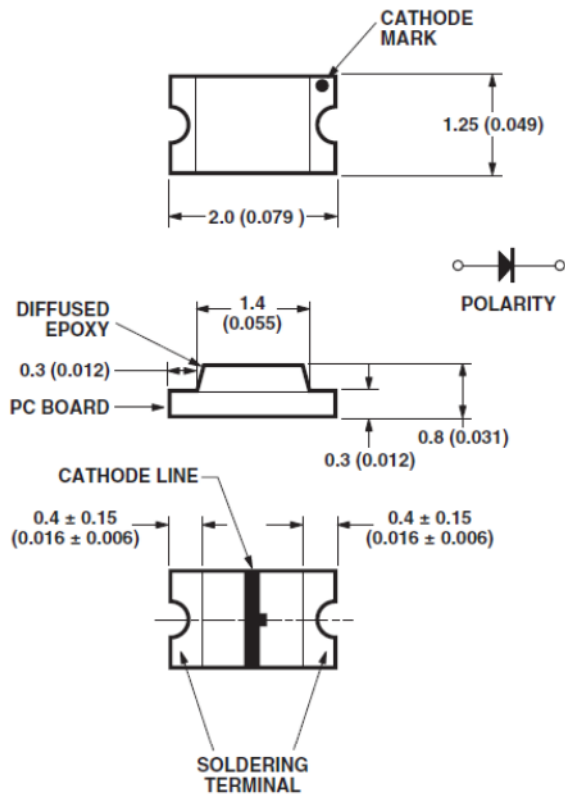

Note:

1. All dimensions in mm (inches).
2. Tolerance ± 0.1 mm (0.004inch) unless otherwise specified.

Caution: LEDs are class 1A ESD sensitive per ANSI/ESDA/JEDEC JS-001. Please observe appropriate precautions during handling and processing. Refer to Application Note AN-1142 for additional details.

Absolute Maximum Ratings (T_A = 25°C)

Parameter	InGaN White	Unit
DC Forward Current ¹	20	mA
Power Dissipation	78	mW
Junction Temperature	95	°C
Operating Temperature Range	-40 to +85	°C
Storage Temperature Range	-40 to +85	°C

Note:

1. Derate as shown in Figure 10.

Electrical / Optical Characteristics (T_A = 25°C, I_F = 20mA)

Parameter	Min	Typ	Max	Unit
Luminous Intensity, I _v ¹	180	370		mcd
Viewing Angle, 2θ _{1/2} ²		170		degree
Forward Voltage, V _f ³	2.9		3.9	V
Reverse Voltage, V _r ⁴ @ I _r = 100μA	5			V
Thermal Resistance, Rθ _{J-P}		300		°C/W

Note:

1. The luminous intensity is measured at the mechanical axis of the lamp package which may not be aligned with the peak of the spatial radiation pattern.
2. θ_{1/2} is the off axis angle where the luminous intensity is ½ the peak intensity.
3. V_f tolerance ±0.1V.
4. Indicates product final test condition, long term reverse bias is not recommended.

Intensity Bin Limits

Bin ID	Min. (mcd)	Max. (mcd)
S	180	285
T	285	450
U	450	715
V	715	1125
W	1125	1800
X	1800	2850
Y	2850	4500

Tolerance ±15%

Color Bin Limits

Bin ID	Chromaticity Coordinates	
	x	y
A1	0.2700	0.2455
	0.2700	0.2780
	0.2500	0.2500
	0.2500	0.2175
A2	0.2700	0.2455
	0.2700	0.2130
	0.2500	0.1850
	0.2500	0.2175
B1	0.2700	0.2455
	0.2700	0.2780
	0.2900	0.3060
	0.2900	0.2735
B2	0.2700	0.2455
	0.2700	0.2130
	0.2900	0.2410
	0.2900	0.2735

Bin ID	Chromaticity Coordinates	
	x	y
C1	0.2900	0.3060
	0.3100	0.3355
	0.3100	0.3030
	0.2900	0.2735
C2	0.2900	0.2410
	0.3100	0.2705
	0.3100	0.3030
	0.2900	0.2735
D1	0.3100	0.3030
	0.3100	0.3355
	0.3300	0.3650
	0.3300	0.3325
D2	0.3100	0.3030
	0.3100	0.2705
	0.3300	0.3000
	0.3300	0.3325

Tolerance ± 0.02

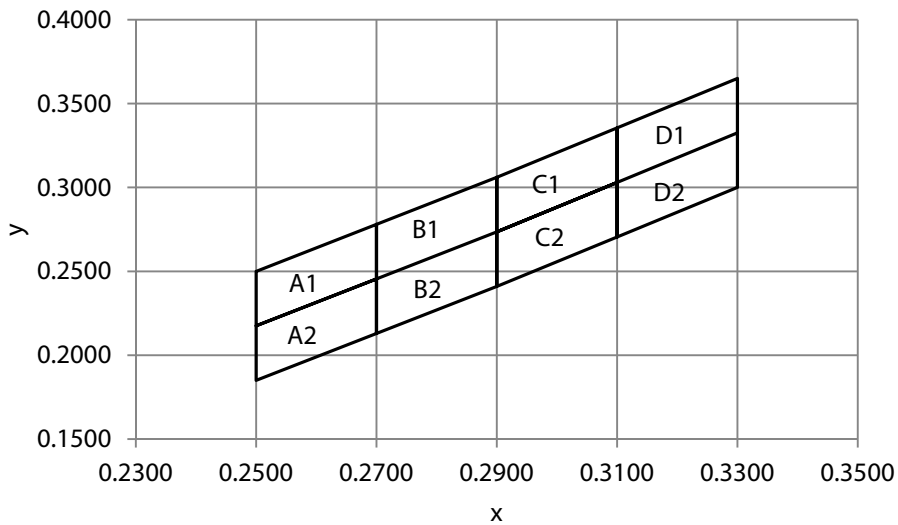

Figure 1. Chromaticity diagram

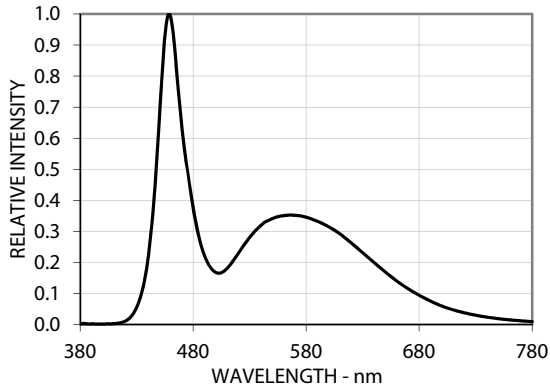

Figure 2. Spectrum

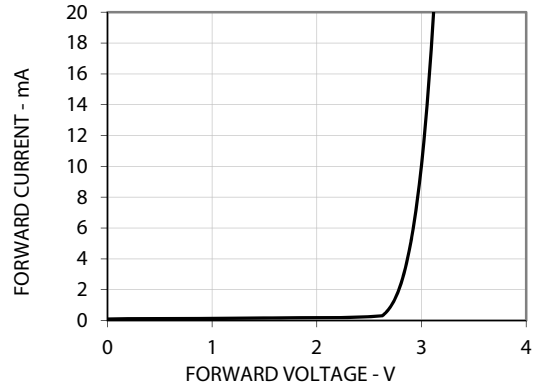

Figure 3. Forward current vs Forward voltage

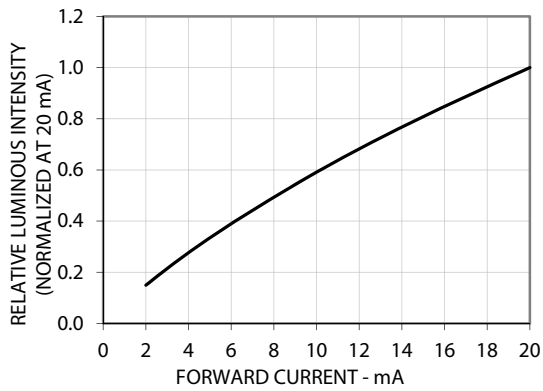

Figure 4. Relative intensity vs Forward current

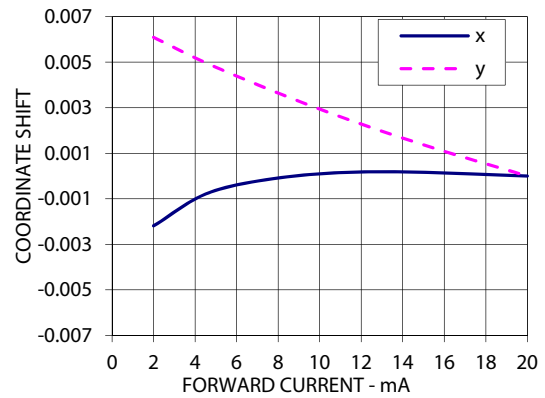

Figure 5. Chromaticity shift vs Forward current

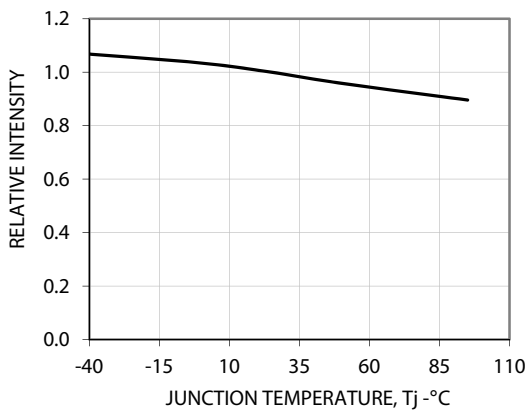

Figure 6. Relative intensity vs Temperature

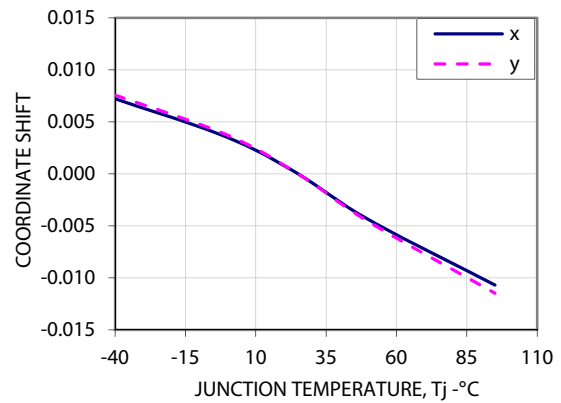

Figure 7. Chromaticity shift vs Temperature

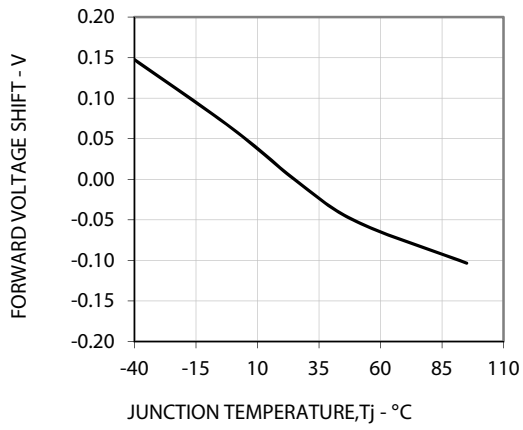

Figure 8. Forward voltage shift vs Temperature

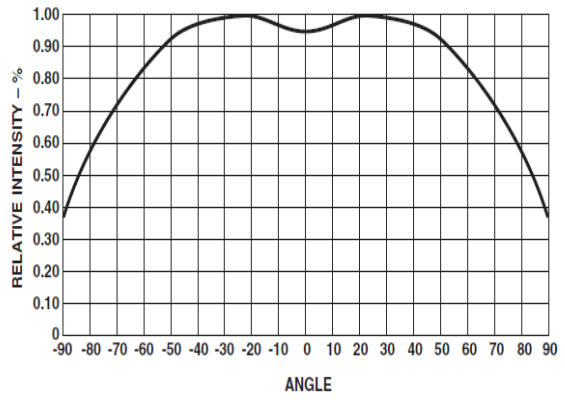

Figure 9. Radiation pattern

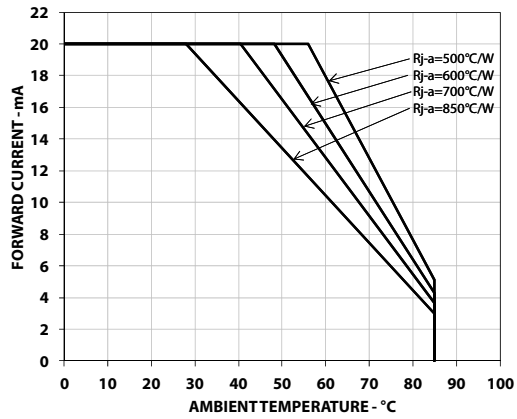

Figure 10. Derating curve

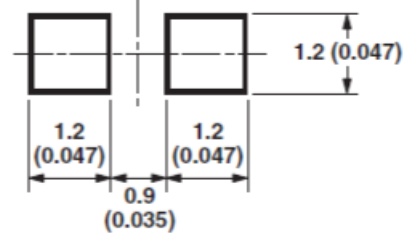

Figure 11. Recommended solder pad

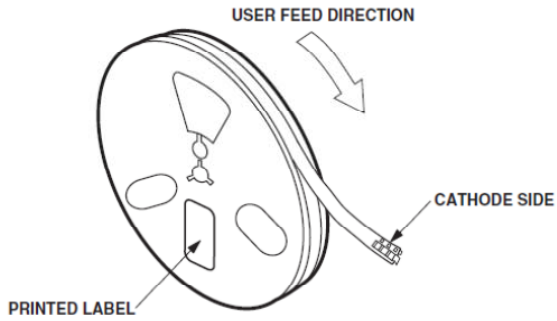

Figure 12. Reeling orientation

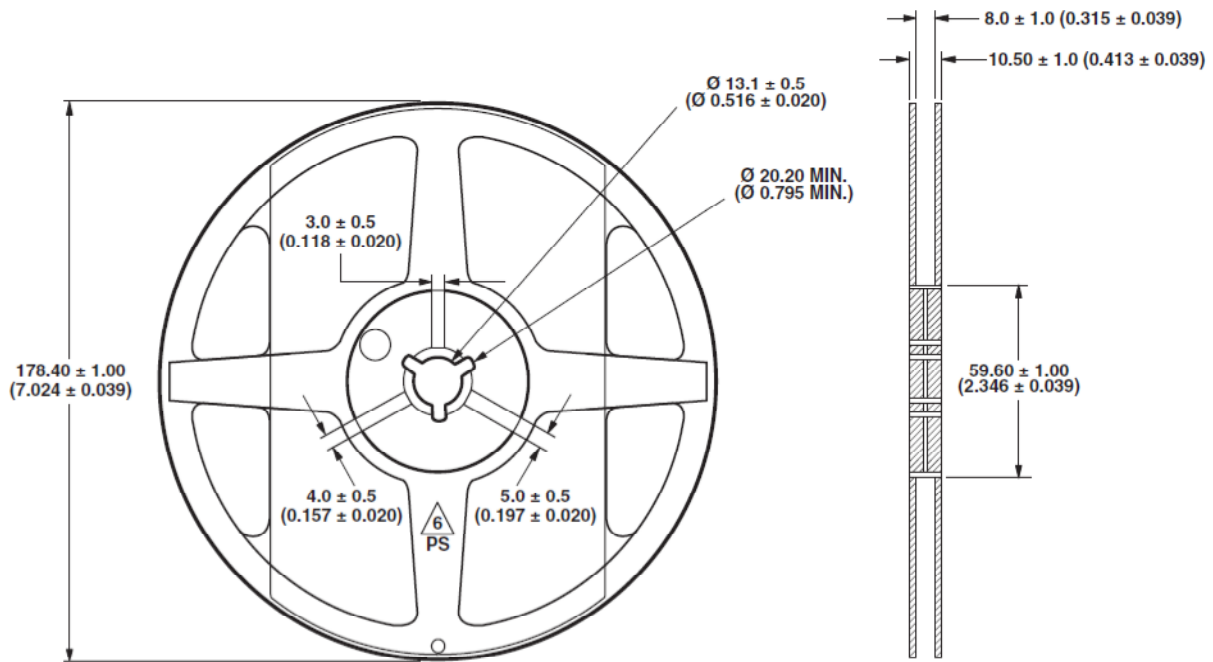

Figure 13. Reel dimensions

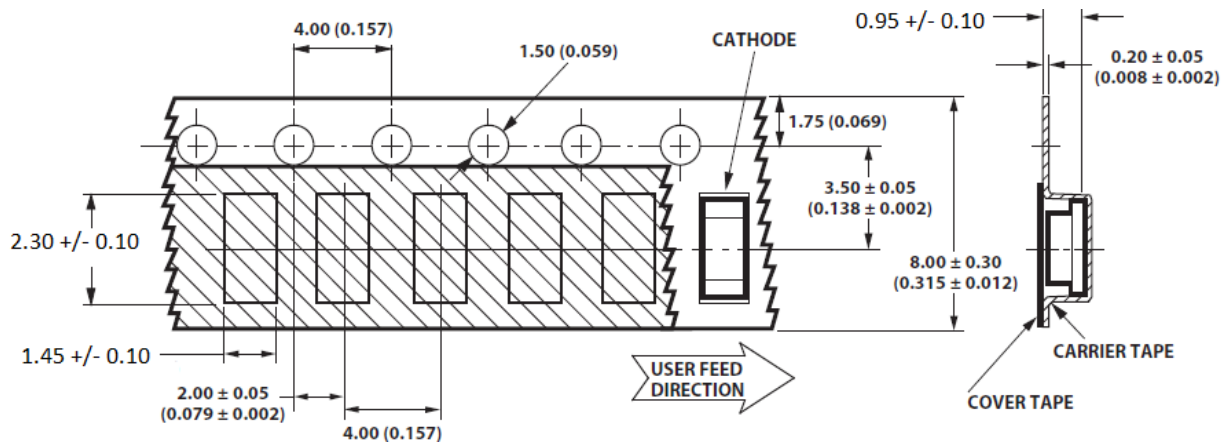
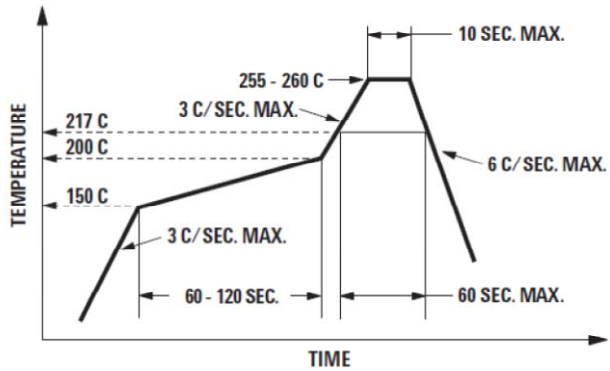

Figure 14. Tape dimensions

Soldering

Recommended reflow soldering condition:



- (a) Reflow soldering must not be done more than 2 times. Do observe necessary precautions of handling moisture sensitive device as stated in below section.
- (b) Do not apply any pressure or force on the LED during reflow and after reflow when the LED is still hot.
- (c) It is preferred to use reflow soldering to solder the LED. But if unavoidable (such as rework), manual hand soldering can be used but must be strictly controlled to condition below:
 - Soldering iron tip temperature = 310°C max
 - Soldering duration = 2sec max
 - Number of cycle = 1 only
 - Power of soldering iron = 50W max
- (d) Do not touch the LED package body with the soldering iron except for the soldering terminals as it may cause damage to the LED.
- (e) User is advised to confirm beforehand whether the functionality and performance of the LED is affected by hand soldering.

PRECAUTIONARY NOTES

1. Handling of moisture sensitive device

This product has a Moisture Sensitive Level 2a rating per JEDEC J-STD-020. Refer to Avago Application Note AN5305, *Handling of Moisture Sensitive Surface Mount Devices*, for additional details and a review of proper handling procedures.

(a) Before use

- An unopened moisture barrier bag (MBB) can be stored at <40°C/90%RH for 12 months. If the actual shelf life has exceeded 12 months and the humidity Indicator Card (HIC) indicates that baking is not required, then it is safe to reflow the LEDs per the original MSL rating.
- It is recommended that the MBB not be opened prior to assembly (e.g. for IQC).

(b) Control after opening the MBB

- The humidity indicator card (HIC) shall be read immediately upon opening of MBB.
- The LEDs must be kept at <30°C / 60%RH at all times and all high temperature related processes including soldering, curing or rework need to be completed within 672 hours.

(c) Control for unfinished reel

- Unused LEDs must be stored in a sealed MBB with desiccant or desiccator at <5%RH.

(d) Control of assembled boards

- If the PCB soldered with the LEDs is to be subjected to other high temperature processes, the PCB need to be stored in sealed MBB with desiccant or desiccator at <5%RH to ensure that all LEDs have not exceeded their floor life of 672 hours.

(e) Baking is required if:

- The HIC indicator is not blue at 10% and is pink at 5%.
- The LEDs are exposed to condition of >30°C / 60% RH at any time.
- The LED floor life exceeded 672hrs.

The recommended baking condition is: 60±5°C for 20hrs

Baking should only be done once.

Disclaimer

Avago's products are not specifically designed, manufactured or authorized for sale as parts, components or assemblies for the planning, construction, maintenance or direct operation of a nuclear facility or for use in medical devices or applications. Customer is solely responsible, and waives all rights to make claims against Avago or its suppliers, for all loss, damage, expense or liability in connection with such use.

For product information and a complete list of distributors, please go to our website: www.avagotech.com

Avago, Avago Technologies, and the A logo are trademarks of Avago Technologies in the United States and other countries. Data subject to change. Copyright © 2005-2014 Avago Technologies. All rights reserved.

Компания «Океан Электроники» предлагает заключение долгосрочных отношений при поставках импортных электронных компонентов на взаимовыгодных условиях!

Наши преимущества:

- Поставка оригинальных импортных электронных компонентов напрямую с производств Америки, Европы и Азии, а так же с крупнейших складов мира;
- Широкая линейка поставок активных и пассивных импортных электронных компонентов (более 30 млн. наименований);
- Поставка сложных, дефицитных, либо снятых с производства позиций;
- Оперативные сроки поставки под заказ (от 5 рабочих дней);
- Экспресс доставка в любую точку России;
- Помощь Конструкторского Отдела и консультации квалифицированных инженеров;
- Техническая поддержка проекта, помощь в подборе аналогов, поставка прототипов;
- Поставка электронных компонентов под контролем ВП;
- Система менеджмента качества сертифицирована по Международному стандарту ISO 9001;
- При необходимости вся продукция военного и аэрокосмического назначения проходит испытания и сертификацию в лаборатории (по согласованию с заказчиком);
- Поставка специализированных компонентов военного и аэрокосмического уровня качества (Xilinx, Altera, Analog Devices, Intersil, Interpoint, Microsemi, Actel, Aeroflex, Peregrine, VPT, Syfer, Eurofarad, Texas Instruments, MS Kennedy, Miteq, Cobham, E2V, MA-COM, Hittite, Mini-Circuits, General Dynamics и др.);

Компания «Океан Электроники» является официальным дистрибьютором и эксклюзивным представителем в России одного из крупнейших производителей разъемов военного и аэрокосмического назначения «JONHON», а так же официальным дистрибьютором и эксклюзивным представителем в России производителя высокотехнологичных и надежных решений для передачи СВЧ сигналов «FORSTAR».



JONHON

«JONHON» (основан в 1970 г.)

Разъемы специального, военного и аэрокосмического назначения:

(Применяются в военной, авиационной, аэрокосмической, морской, железнодорожной, горно- и нефтедобывающей отраслях промышленности)

«FORSTAR» (основан в 1998 г.)

ВЧ соединители, коаксиальные кабели, кабельные сборки и микроволновые компоненты:

(Применяются в телекоммуникациях гражданского и специального назначения, в средствах связи, РЛС, а так же военной, авиационной и аэрокосмической отраслях промышленности).



Телефон: 8 (812) 309-75-97 (многоканальный)

Факс: 8 (812) 320-03-32

Электронная почта: ocean@oceanchips.ru

Web: <http://oceanchips.ru/>

Адрес: 198099, г. Санкт-Петербург, ул. Калинина, д. 2, корп. 4, лит. А