



FINGERSTOCK, GASKETS AND METAL GROUNDING PRODUCTS

LET
NOTHING
INTERFERE.™

BERYLLIUM COPPER SOLUTIONS AND BEYOND.

Beryllium copper has remarkable stability, superior tensile strength, impressive thermal and electrical conductivity, and high shielding attenuation values. Which is why Laird Technologies® offers over 250 different configurations of beryllium copper shielding. Beyond beryllium copper, we also offer shielding and custom-engineered stampings in stainless steel, brass, phosphor bronze and other special alloys.



Large-volume requirements are readily met by our high-speed Bruderer punch presses.



Heat-treating, critical to imparting the specific mechanical qualities to the spring materials, is computer-controlled. All heat treated batches are also quality tested for hardness and specifications.



Photo-chemical machining produces extremely intricate and complex parts to precise specifications and provides a cost-effective alternative to tooling.



Large bed presses enable Laird Technologies to process a wide variety of material types and thicknesses to broaden our metals capability and offer customized solutions from shielding, grounding or non-EMI applications.



From design to totally automated assembly, Laird Technologies offers complete control of your assembled product.



Multi-slide machines offer economical production options.



Our precision plating departments support and strictly comply with environmental, health and safety standards while offering a wide variety of plating finishes.











This environment-friendly, aqueous degreasing unit for removing stamping oils cleans with a mild alkaline solution—eliminating the need for chlorinated solvents.

TABLE OF CONTENTS

As the world's leading fabricator of fingerstock, Laird Technologies has developed highly sophisticated, and often proprietary, shielding and grounding technology. Our innovations are necessary to achieve outstanding combinations of performance parameters. From a vast selection of product configurations, platings and mounting techniques, to a full range of low compression

force requirements and high transfer impedance characteristics, there is a Laird Technologies gasket or grounding product just right for the job.

Depending upon the manufacturing process, some parts will be supplied with holes for cleaning and plating purposes. These holes will not affect the overall performance of the product.

	VISUAL PART NUMBER REFERENCE GUIDE	1-2			
	PART NUMBER CROSS REFERENCE	1-4			
	MOUNTING METHODS	1-10			
	ORDERING INFORMATION	1-11			
	FINGERSTOCK GASKETS AND METAL GROUNDING PRODUCTS				
	Slot Mount Series	2-1			
	Dual Slot Series	2-3			
	Compact PCI Symmetrical Mount	2-4			
	Alternate Slot Series	2-4			
	Variable Slot Mount	2-5			
	No Snag Gasket	2-6			
	Symmetrical (S ³) Slotted Shielding	2-7			
	Solid Top (S ³) Symmetrical Slotted Shielding	2-8			
	Clip-On Symmetrical Shielding	2-9			
	All-Purpose Series	2-10			
	Clip-On Series	2-11			
	Low Profile Hook-On Gasket	2-13			
	Low Profile Gasket	2-13			
	Large Enclosure Series	2-14			
	Double-Sided Contact Strips	2-14			
	Foldover Series	2-15			
	Flexible Low Compression Series	2-15			
	Twist Series	2-16			
	Clip-On Twist Series	2-17			
	Divider Edge Shielding	2-18			
	Card Guide Clip-On	2-18			
	Clip-On Perpendicular Shielding	2-19			
	Clip-On Perpendicular Grounding Strip	2-19			
	Clip-On Longitudinal Grounding Strip	2-20			
	Mini-Longitudinal Grounding Gasket	2-20			
	Longitudinal Grounding Series	2-21			
	UltraSoft® Gasket Series	2-21			
	Battery Contacts	2-22			
	Custom Stamping	2-24			
	Drawn Can Board Level Shields	2-27			
	Contact Strips	2-28			
	Contact Rings	2-32			
	Load/Deflection Data	2-33			
	Shielding Effectiveness Charts	2-38			
	METAL CONNECTOR SHIELDS				
	Stainless Steel I/O Shielding	3-1			
	"D" Connector Shielding	3-2			
	Slotted D Connector Shielding	3-2			
	DIN Connector Series	3-3			
	USB Connector	3-3			
	IEEE 1394 Horizontal Connector Gasket	3-4			
	Fiber Optic Shield	3-5			
	GBIC Fiber Optic Shield	3-5			
	CONTACTS				
	Custom Design Contacts	4-1			
	Standard Design Contacts	4-2			
	CORROSION OF EMI GASKETS	5-1			

IMPORTANT SHIELDING SELECTION CONSIDERATIONS

Consider these important factors in the selection of appropriate shielding products for your design:

- | | | | |
|---|--|--|--|
| <input type="checkbox"/> Operating Frequency | <input type="checkbox"/> Commercial or Military Worldwide Compliance | <input type="checkbox"/> Fastening/Mounting Methods | <input type="checkbox"/> Electrical Requirements |
| <input type="checkbox"/> Materials Compatibility | <input type="checkbox"/> Operating Environment | <input type="checkbox"/> Storage Environment | <input type="checkbox"/> Materials Thickness/Alloy |
| <input type="checkbox"/> Corrosive Considerations | <input type="checkbox"/> Load/Forces | <input type="checkbox"/> Nuclear, Biological, Chemical (NBC) | <input type="checkbox"/> Space/Weight Considerations |
| | <input type="checkbox"/> Cost | <input type="checkbox"/> Cycle Life | <input type="checkbox"/> Product Safety |
| | <input type="checkbox"/> Attenuation Performance | <input type="checkbox"/> Shielding/Grounding/Other | <input type="checkbox"/> Recyclability |

Visit www.lairdtech.com's knowledge base for downloadable PDF's of all other Laird Technologies catalogs, tech notes, application notes and more!



FINGERSTOCK GASKETS AND METAL GROUNDING PRODUCTS

<p>Slot Mount Series</p>  <p>Page 2-1</p>	<p>Dual Slot Mount Series</p>  <p>Page 2-3</p>	<p>Compact PCI Slot Mount</p>  <p>Page 2-4</p>	<p>Alternate Slot Mount</p>  <p>Page 2-4</p>	<p>Variable Slot Mount</p>  <p>Page 2-5</p>
<p>No Snag Gaskets</p>  <p>Page 2-6</p>	<p>Symmetrical (S³) Slotted Shielding</p>  <p>Page 2-7</p>	<p>Solid Top (S³) Symmetrical Slotted Shielding</p>  <p>Page 2-8</p>	<p>Clip-On Symmetrical Shielding</p>  <p>Page 2-9</p>	<p>All-Purpose Series</p>  <p>Page 2-10</p>
<p>Clip-On Series</p>  <p>Page 2-11</p>	<p>Low Profile Hook-On Gasket</p>  <p>Page 2-13</p>	<p>Low Profile Gasket</p>  <p>Page 2-13</p>	<p>Large Enclosure Series</p>  <p>Page 2-14</p>	<p>Double-Sided Contact Strips</p>  <p>Page 2-14</p>
<p>Foldover Series</p>  <p>Page 2-15</p>	<p>Flexible Low Compression Series</p>  <p>Page 2-15</p>	<p>Twist Series</p>  <p>Page 2-16</p>	<p>Clip-On Twist Series</p>  <p>Page 2-17</p>	
<p>Divider Edge Shield</p>  <p>Page 2-18</p>				
<p>Card Guide Clip-On</p>  <p>Page 2-18</p>				



VISUAL PART REFERENCE GUIDE

FINGERSTOCK GASKETS AND METAL GROUNDING PRODUCTS (CONTINUED)

Clip-On Perpendicular Shielding



Page 2-19

Clip-On Perpendicular Grounding Strip



Page 2-19

Clip-On Longitudinal Grounding Strip



Page 2-20

Mini-Longitudinal Grounding Gasket



Page 2-20

Longitudinal Grounding Series



Page 2-21

Battery Contacts



Page 2-22

Contact Strips



Page 2-28

Contact Rings



Page 2-32

METAL CONNECTOR SHIELDS

Stainless Steel I/O Shielding



Page 3-1

"D" Connector Series



Page 3-2

Slotted D Connector Shields



Page 3-2

DIN Connector Series



Page 3-3

USB Connector



Page 3-3

IEEE 1394 Horizontal Connector Gasket



Page 3-4

Fiber Optic Shield



Page 3-5

GBIC Fiber Optic Shield



Page 3-5

CONTACTS

Standard Contacts



Page 4-2

PART NUMBER CROSS REFERENCE



When ordering, please call our sales department to confirm availability and lead times.

PART NO.	PRODUCT	SIZE	PAGE NO.
BMIC-001	STANDARD CONTACTS		Page 4-2
BMIC-004	STANDARD CONTACTS		Page 4-2
BMIC-007-01	STANDARD CONTACTS		Page 4-2
BMIC-010	STANDARD CONTACTS		Page 4-2
77-010	SLOT MOUNT SERIES	16 (406.400) LENGTH	Page 2-1, 2-2
77-011	SLOT MOUNT SERIES	16 (406.400) LENGTH	Page 2-1, 2-2
77-012	NO SNAG GASKET	24 (609.600) LENGTH	Page 2-6
77-014	NO SNAG GASKET	24 (609.600) LENGTH	Page 2-6
77-015	SLOT MOUNT SERIES	SINGLE FINGER 0.250 (6.350)	Page 2-1, 2-2
77-016	SLOT MOUNT SERIES	SINGLE FINGER 0.169 (4.293)	Page 2-2
77-017	SLOT MOUNT SERIES	TWO FINGERS 0.356 (9.042)	Page 2-2
77-018	SLOT MOUNT SERIES	THREE FINGERS 0.543 (13.792)	Page 2-1, 2-2
77-019	SLOT MOUNT SERIES	FOUR FINGERS 0.730 (18.542)	Page 2-2
77-020	SLOT MOUNT SERIES	TWO FINGERS 0.532 (13.513)	Page 2-2
77-021	SLOT MOUNT SERIES	16 (406.400) LENGTH	Page 2-2
77-023	SLOT MOUNT SERIES	SINGLE FINGER 0.225 (5.715)	Page 2-2
77-024	SLOT MOUNT SERIES	TWO FINGERS 0.475 (12.065)	Page 2-2
77-025	SLOT MOUNT SERIES	THREE FINGERS 0.725 (18.415)	Page 2-2
77-026	SLOT MOUNT SERIES	FOUR FINGERS 0.975 (24.765)	Page 2-2
77-027	SLOT MOUNT SERIES	FIVE FINGERS 1.225 (31.115)	Page 2-2
77-028	SLOT MOUNT SERIES	SIX FINGERS 1.475 (37.465)	Page 2-2
77-029	SLOT MOUNT SERIES	SINGLE FINGER 0.343 (8.712)	Page 2-2
77-030	SLOT MOUNT SERIES	TWO FINGERS 0.718 (18.237)	Page 2-2
77-031	SLOT MOUNT SERIES	THREE FINGERS 1.093 (27.762)	Page 2-2
77-032	SLOT MOUNT SERIES	FOUR FINGERS 1.468 (37.287)	Page 2-2
77-033	NO SNAG GASKET	16 (406.400) LENGTH	Page 2-6
77-035	SLOT MOUNT SERIES	TWO FINGERS 0.480 (12.192)	Page 2-2
77-036	SLOT MOUNT SERIES	FOUR FINGERS 0.980 (24.892)	Page 2-2
77-037	SLOT MOUNT SERIES	SIX FINGERS 1.480 (37.592)	Page 2-2
77-038	SLOT MOUNT SERIES	EIGHT FINGERS 1.980 (50.292)	Page 2-2
77-039	SLOT MOUNT SERIES	SINGLE FINGER 0.169 (4.293)	Page 2-2
77-040	SLOT MOUNT SERIES	TWO FINGERS 0.356 (9.042)	Page 2-2
77-041	SLOT MOUNT SERIES	THREE FINGERS 0.543 (13.792)	Page 2-2
77-042	SLOT MOUNT SERIES	FOUR FINGERS 0.730 (18.542)	Page 2-2
77-043	LOW PROFILE GASKET	16 (406.400) LENGTH	Page 2-13
77-044	SLOT MOUNT SERIES	SIX FINGERS 1.104 (28.042)	Page 2-2
77-045	SLOT MOUNT SERIES	SINGLE FINGER 0.169 (4.293)	Page 2-2
77-046	SLOT MOUNT SERIES	TWO FINGERS 0.356 (9.042)	Page 2-2
77-047	SLOT MOUNT SERIES	THREE FINGERS 0.543 (13.792)	Page 2-2
77-048	SLOT MOUNT SERIES	FOUR FINGERS 0.730 (18.542)	Page 2-2
77-049	LOW PROFILE GASKET	16 (406.400) LENGTH	Page 2-13
77-050	SLOT MOUNT SERIES	FIVE FINGERS 0.917 (23.292)	Page 2-2
77-051	SLOT MOUNT SERIES	SIX FINGERS 1.104 (28.042)	Page 2-2
77-052	SLOT MOUNT SERIES	SEVEN FINGERS 1.291 (32.791)	Page 2-2
77-053	SLOT MOUNT SERIES	EIGHT FINGERS 1.478 (37.541)	Page 2-2
77-054	SLOT MOUNT SERIES	NINE FINGERS 1.665 (42.291)	Page 2-2
77-055	SLOT MOUNT SERIES	TEN FINGERS 1.852 (47.041)	Page 2-2
77-056	VARIABLE SLOT MOUNT	16 (406.400) LENGTH	Page 2-5
77-057	VARIABLE SLOT MOUNT	16 (406.400) LENGTH	Page 2-5
77-058	SLOT MOUNT SERIES	FIVE FINGERS 0.917 (23.292)	Page 2-2
77-059	SLOT MOUNT SERIES	16 (406.400) LENGTH	Page 2-2
77-060	VARIABLE SLOT MOUNT	16 (406.400) LENGTH	Page 2-5
77-061	VARIABLE SLOT MOUNT	16 (406.400) LENGTH	Page 2-5
77-062	SLOT MOUNT SERIES	SINGLE FINGER 0.169 (4.293)	Page 2-2
77-063	SLOT MOUNT SERIES	TWO FINGERS 0.356 (9.042)	Page 2-2
77-064	SLOT MOUNT SERIES	THREE FINGERS 0.543 (13.792)	Page 2-2
77-065	SLOT MOUNT SERIES	FOUR FINGERS 0.730 (18.542)	Page 2-2
77-066	VARIABLE SLOT MOUNT	16 (406.400) LENGTH	Page 2-5

All dimensions shown are in inches (millimeters) unless otherwise specified.



PART NO.	PRODUCT	SIZE	PAGE NO.
77-070	SLOT MOUNT SERIES	16 (406.400) LENGTH	Page 2-2
77-071	LOW PROFILE HOOK-ON	16.2 (411.480) LENGTH	Page 2-13
77-072	LOW PROFILE HOOK-ON	16.2 (411.480) LENGTH	Page 2-13
77-075	DUAL SLOT SERIES	16 (406.400) LENGTH	Page 2-3
77-076	SLOT MOUNT SERIES	SINGLE FINGER 0.340 (8.636)	Page 2-2
77-077	COMPACT PCI SYMMETRICAL MOUNT	16 (406.400) LENGTH	Page 2-4
77-078	NO SNAG GASKET	24 (609.600) LENGTH	Page 2-6
77-079	NO SNAG GASKET	16 (406.400) LENGTH	Page 2-6
77-081	NO SNAG GASKET	24 (609.600) LENGTH	Page 2-6
77-082	NO SNAG GASKET	24 (609.600) LENGTH	Page 2-6
77-083	NO SNAG GASKET	16 (406.400) LENGTH	Page 2-6
77-084	NO SNAG GASKET	16 (406.400) LENGTH	Page 2-6
77-085	NO SNAG GASKET	18 (457.200) LENGTH	Page 2-6
77-086	NO SNAG GASKET	16 (406.000) LENGTH	Page 2-6
77-087	SLOT MOUNT SERIES	SEVEN FINGERS 1.291 (32.791)	Page 2-2
77-088	SLOT MOUNT SERIES	EIGHT FINDERS 1.478 (37.541)	Page 2-2
77-089	SLOT MOUNT SERIES	THREE FINGERS 0.810 (20.574)	Page 2-2
77-090	VARIABLE SLOT MOUNT	16 (406.400) LENGTH	Page 2-5
77-091	NO SNAG GASKET	18 (457.200) LENGTH	Page 2-6
77-092	NO SNAG GASKET	18 (457.200) LENGTH	Page 2-6
77-093	DUAL SLOT SERIES	16.000 (406.400)	Page 2-3
77-094	SLOT MOUNT SERIES	TWO FINGERS 0.389 (9.881)	Page 2-2
77-096	SLOT MOUNT SERIES	FOUR FINGERS 1.096 (27.838)	Page 2-2
77-097	SLOT MOUNT SERIES	16.000 (406.400)	Page 2-2
77-098	ALTERNATE SLOT SERIES	14.590 (370.586) LENGTH	Page 2-4
77-099	SLOT MOUNT SERIES	FIVE FINGERS 1.378 (35.001)	Page 2-2
77-100	SLOT MOUNT SERIES	SIX FINGERS 1.660 (42.164)	Page 2-2
77-101	SLOT MOUNT SERIES	SEVEN FINGERS 1.942 (49.327)	Page 2-2
77-105	VARIABLE SLOT MOUNT	16 (406.400) LENGTH	Page 2-5
77-106	VARIABLE SLOT MOUNT	16 (406.400) LENGTH	Page 2-5
77-107	VARIABLE SLOT MOUNT	16 (406.400) LENGTH	Page 2-5
77-110	DUAL SLOT SERIES	16.000 (406.400)	Page 2-3
78-XXX	Most standard profiles are available in UltraSoft® low compression force (78 and 98) series. Please call our sales department for availability.		
95-702	GBIC FIBER OPTIC SHIELD		Page 3-5
95-822	SLOTTED "D" CONNECTOR SHIELDING	9 PIN STAINLESS STEEL	Page 3-2
95-823	SLOTTED "D" CONNECTOR SHIELDING	9 PIN STAINLESS STEEL	Page 3-2
95-824	SLOTTED "D" CONNECTOR SHIELDING	15 PIN STAINLESS STEEL	Page 3-2
95-825	SLOTTED "D" CONNECTOR SHIELDING	15 PIN STAINLESS STEEL	Page 3-2
95-826	SLOTTED "D" CONNECTOR SHIELDING	25 PIN STAINLESS STEEL	Page 3-2
95-827	SLOTTED "D" CONNECTOR SHIELDING	25 PIN STAINLESS STEEL	Page 3-2
95-828	SLOTTED "D" CONNECTOR SHIELDING	37 PIN STAINLESS STEEL	Page 3-2
95-901	SYMMETRICAL S3 SERIES	0.284 (7.214)	Page 2-7
95-902	SYMMETRICAL S3 SERIES	0.325 (8.255)	Page 2-7
95-1000	STAINLESS STEEL I/O SHIELDING		Page 3-1
97-070	FEMALE CONTACT RING	O.D. 0.1.219 (30.963)	Page 2-32
97-072	FEMALE CONTACT RING	O.D. 1.000 (25.400)	Page 2-32
97-074	FEMALE CONTACT RING	O.D. 0.875 (22.225)	Page 2-32
97-076	FEMALE CONTACT RING	O.D. 0.640 (16.256)	Page 2-32
97-105	CONTACT STRIPS	16 (406.400) LENGTH	Page 2-28, 2-29
97-110	CONTACT STRIPS	16 (406.400) LENGTH	Page 2-28, 2-29
97-111	CONTACT STRIPS	16 (406.400) LENGTH	Page 2-28, 2-29
97-112	CONTACT STRIPS	16 (406.400) LENGTH	Page 2-28, 2-29
97-113	CONTACT STRIPS	16 (406.400) LENGTH	Page 2-28, 2-29
97-114	CONTACT STRIPS	16 (406.400) LENGTH	Page 2-28, 2-29
97-115	CONTACT STRIPS	16 (406.400) LENGTH	Page 2-28, 2-29
97-116	CONTACT STRIPS	16 (406.400) LENGTH	Page 2-28, 2-29
97-117	CONTACT STRIPS	16 (406.400) LENGTH	Page 2-28, 2-29

All dimensions shown are in inches (millimeters) unless otherwise specified.



PART NO.	PRODUCT	SIZE	PAGE NO.
97-134	CONTACT STRIPS	16 (406.400) LENGTH	Page 2-30, 2-31
97-135	CONTACT STRIPS	16 (406.400) LENGTH	Page 2-29
97-136	CONTACT STRIPS	16 (406.400) LENGTH	Page 2-30, 2-31
97-137	CONTACT STRIPS	16 (406.400) LENGTH	Page 2-30, 2-31
97-139	CONTACT STRIPS	16 (406.400) LENGTH	Page 2-30, 2-31
97-140	FEMALE CONTACT RING	O.D. 0.290 (7.366)	Page 2-32
97-141	FEMALE CONTACT RING	O.D. 0.440 (11.176)	Page 2-32
97-142	FEMALE CONTACT RING	O.D. 0.550 (13.970)	Page 2-32
97-143	FEMALE CONTACT RING	O.D. 0.800 (20.320)	Page 2-32
97-150	MALE CONTACT RING	I.D. 0.210 (5.334)	Page 2-33
97-151	MALE CONTACT RING	I.D. 0.330 (8.382)	Page 2-33
97-152	MALE CONTACT RING	I.D. 0.450 (11.430)	Page 2-33
97-153	MALE CONTACT RING	I.D. 0.690 (17.526)	Page 2-33
97-154	MALE CONTACT RING	I.D. 0.950 (24.130)	Page 2-33
97-155	MALE CONTACT RING	I.D. 1.450 (36.830)	Page 2-33
97-156	MALE CONTACT RING	I.D. 1.950 (49.530)	Page 2-33
97-185	FEMALE CONTACT RING	O.D. 0.560 (14.224)	Page 2-32
97-192	MALE CONTACT RING	I.D. 0.450 (11.430)	Page 2-33
97-204	FEMALE CONTACT RING	O.D. 1.040 (26.416)	Page 2-32
97-205	MALE CONTACT RING	I.D. 0.890 (22.606)	Page 2-33
97-210	CONTACT STRIPS	12 (304.800) LENGTH	Page 2-31
97-211	CONTACT STRIPS	12 (304.800) LENGTH	Page 2-31
97-215	MALE CONTACT RING	I.D. 1.240 (31.496)	Page 2-33
97-216	FEMALE CONTACT RING	O.D. 1.240 (31.496)	Page 2-32
97-221	CONTACT STRIPS	12 (304.800) LENGTH	Page 2-29
97-223	CONTACT STRIPS	16 (406.400) LENGTH	Page 2-30, 2-31
97-232	FEMALE CONTACT RING	O.D. 0.540 (13.716)	Page 2-32
97-241	MALE CONTACT RING	I.D. 0.340 (8.636)	Page 2-33
97-251	CONTACT STRIPS	12 (304.800) LENGTH	Page 2-29
97-252	FEMALE CONTACT RING	O.D. 1.250 (31.750)	Page 2-32
97-254	FEMALE CONTACT RING	O.D. 0.910 (23.114)	Page 2-32
97-255	FEMALE CONTACT RING	O.D. 0.650 (16.510)	Page 2-32
97-290	CONTACT STRIPS	16 (406.400) LENGTH	Page 2-30, 2-31
97-300	CONTACT STRIPS	16 (406.400) LENGTH	Page 2-28, 2-29
97-310	CONTACT STRIPS	15 (381.000) LENGTH	Page 2-29
97-313	CONTACT STRIPS	16 (406.400) LENGTH	Page 2-29
97-320	CONTACT STRIPS	16 (406.400) LENGTH	Page 2-30, 2-31
97-330	CONTACT STRIPS	16 (406.400) LENGTH	Page 2-30, 2-31
97-340	CONTACT STRIPS	16 (406.400) LENGTH	Page 2-29
97-360	CONTACT STRIPS	16 (406.400) LENGTH	Page 2-30, 2-31
97-361	FEMALE CONTACT RING	O.D. 1.010 (25.654)	Page 2-32
97-370	CONTACT STRIPS	16 (406.400) LENGTH	Page 2-31
97-380	CONTACT STRIPS	16 (406.400) LENGTH	Page 2-30, 2-31
97-381	FEMALE CONTACT RING	O.D. 1.210 (30.734)	Page 2-32
97-390	CONTACT STRIPS	16 (406.400) LENGTH	Page 2-29
97-410	CONTACT STRIPS	16 (406.400) LENGTH	Page 2-30, 2-31
97-420	FEMALE CONTACT RING	O.D. 0.500 (12.700)	Page 2-32
97-421	FEMALE CONTACT RING	O.D. 0.500 (12.700)	Page 2-32
97-422	FEMALE CONTACT RING	O.D. 0.600 (15.240)	Page 2-32
97-423	FEMALE CONTACT RING	O.D. 0.780 (19.812)	Page 2-32
97-424	FEMALE CONTACT RING	O.D. 1.050 (26.670)	Page 2-32
97-430	CONTACT STRIPS	16 (406.400) LENGTH	Page 2-31
97-436	DOUBLE-SIDED CONTACT STRIPS	25' (7.6 m) COILS	Page 2-14
97-438	LARGE ENCLOSURE SERIES	25' (7.6 m) COILS	Page 2-14
97-440	LARGE ENCLOSURE SERIES	25' (7.6 m) COILS	Page 2-14
97-445	QUICK SPRING CLIP FASTENER		Page 2-14
97-487	BATTERY CONTACTS		Page 2-22
97-488	BATTERY CONTACTS		Page 2-22

All dimensions shown are in inches (millimeters) unless otherwise specified.



PART NO.	PRODUCT	SIZE	PAGE NO.
97-489	BATTERY CONTACTS		Page 2-22, 2-23
97-490	BATTERY CONTACTS		Page 2-22, 2-23
97-500	ALL-PURPOSE GASKET	24 (609.600) LENGTH	Page 2-10
97-505	ALL-PURPOSE GASKET	24 (609.600) LENGTH	Page 2-10
97-510	ALL-PURPOSE GASKET	24 (609.600) LENGTH	Page 2-10
97-515	FOLDOVER SERIES	24 (609.600) LENGTH	Page 2-15
97-520	ALL-PURPOSE GASKET	16 (406.400) LENGTH	Page 2-10
97-521	FOLDOVER SERIES	16 (406.400) LENGTH	Page 2-15
97-525	ALL-PURPOSE GASKET	16 (406.400) LENGTH	Page 2-10
97-527	ALL-PURPOSE GASKET	24 (609.600) LENGTH	Page 2-10
97-535	ALL-PURPOSE GASKET	12 (304.800) LENGTH	Page 2-10
97-536	ALL-PURPOSE GASKET	24 (609.600) LENGTH	Page 2-10
97-537	ALL-PURPOSE GASKET	12 (304.800) LENGTH	Page 2-10
97-538	ALL-PURPOSE GASKET	24 (609.600) LENGTH	Page 2-10
97-540	ALL-PURPOSE GASKET	16 (406.400) LENGTH	Page 2-10
97-541	FOLDOVER SERIES	16 (406.400) LENGTH	Page 2-15
97-542	FOLDOVER SERIES	16 (406.400) LENGTH	Page 2-15
97-544	ALL-PURPOSE GASKET	16 (406.400) LENGTH	Page 2-10
97-545	ALL-PURPOSE GASKET	12 (304.800) LENGTH	Page 2-10
97-548	ALL-PURPOSE GASKET	24 (609.600) LENGTH	Page 2-10
97-550	TWIST SERIES	24 (609.600) LENGTH	Page 2-16
97-551	TWIST SERIES	24 (609.600) LENGTH	Page 2-16
97-552	CLIP-ON TWIST SERIES	16 (406.400) LENGTH	Page 2-17
97-553	CLIP-ON TWIST SERIES	16 (406.400) LENGTH	Page 2-17
97-555	TWIST SERIES	24 (609.600) LENGTH	Page 2-16
97-556	TWIST SERIES	24 (609.600) LENGTH	Page 2-16
97-558	TWIST SERIES	24 (609.600) LENGTH	Page 2-16
97-559	TWIST SERIES	24 (609.600) LENGTH	Page 2-16
97-560	TWIST SERIES	24 (609.600) LENGTH	Page 2-16
97-561	TWIST SERIES	24 (609.600) LENGTH	Page 2-16
97-563	CLIP-ON TWIST SERIES	16 (406.400) LENGTH	Page 2-17
97-564	CLIP-ON TWIST SERIES	16 (406.400) LENGTH	Page 2-17
97-567	TWIST SERIES	24 (609.600) LENGTH	Page 2-16
97-568	CLIP-ON TWIST SERIES	16 (406.400) LENGTH	Page 2-17
97-569	TWIST SERIES	24 (609.600) LENGTH	Page 2-16
97-572	CLIP-ON TWIST SERIES	16 (406.400) LENGTH	Page 2-17
97-573	CLIP-ON TWIST SERIES	16 (406.400) LENGTH	Page 2-17
97-574	CLIP-ON TWIST SERIES	16 (406.400) LENGTH	Page 2-17
97-575	CLIP-ON TWIST SERIES	16 (406.400) LENGTH	Page 2-17
97-576	CLIP-ON TWIST SERIES	16 (406.400) LENGTH	Page 2-17
97-577	CLIP-ON TWIST SERIES	16 (406.400) LENGTH	Page 2-17
97-578	CLIP-ON TWIST SERIES	16 (406.400) LENGTH	Page 2-17
97-579	CLIP-ON TWIST SERIES	16 (406.400) LENGTH	Page 2-17
97-580	CLIP-ON TWIST SERIES	16 (406.400) LENGTH	Page 2-17
97-581	CLIP-ON TWIST SERIES	16 (406.400) LENGTH	Page 2-17
97-582	CLIP-ON TWIST SERIES	16 (406.400) LENGTH	Page 2-17
97-583	CLIP-ON TWIST SERIES	16 (406.400) LENGTH	Page 2-17
97-584	CLIP-ON TWIST SERIES	16 (406.400) LENGTH	Page 2-17
97-585	CLIP-ON TWIST SERIES	16 (406.400) LENGTH	Page 2-17
97-586	CLIP-ON TWIST SERIES	16 (406.400) LENGTH	Page 2-17
97-587	CLIP-ON TWIST SERIES	16 (406.400) LENGTH	Page 2-17
97-589	CLIP-ON TWIST SERIES	24 (609.000) LENGTH	Page 2-17
97-590	CLIP-ON TWIST SERIES	16 (406.400) LENGTH	Page 2-17
97-593	CLIP-ON TWIST SERIES	16 (406.400) LENGTH	Page 2-17
97-603	CLIP-ON GASKET	16 (406.400) LENGTH	Page 2-11, 2-12
97-604	CLIP-ON GASKET	16 (406.400) LENGTH	Page 2-11, 2-12
97-605	CLIP-ON GASKET	16 (406.400) LENGTH	Page 2-11, 2-12
97-606	CLIP-ON GASKET	16 (406.400) LENGTH	Page 2-11, 2-12

All dimensions shown are in inches (millimeters) unless otherwise specified.



PART NO.	PRODUCT	SIZE	PAGE NO.
97-607	CLIP-ON GASKET	16 (406.400) LENGTH	Page 2-11, 2-12
97-610	CLIP-ON GASKET	16 (406.400) LENGTH	Page 2-11, 2-12
97-611	CLIP-ON GASKET	16 (406.400) LENGTH	Page 2-11, 2-12
97-612	CLIP-ON GASKET	16 (406.400) LENGTH	Page 2-11, 2-12
97-613	CLIP-ON GASKET	16 (406.400) LENGTH	Page 2-11, 2-12
97-614	CLIP-ON GASKET	16 (406.400) LENGTH	Page 2-11, 2-12
97-615	CLIP-ON GASKET	16 (406.400) LENGTH	Page 2-11, 2-12
97-616	CLIP-ON GASKET	16 (406.400) LENGTH	Page 2-11, 2-12
97-618	CLIP-ON GASKET	16 (406.400) LENGTH	Page 2-11, 2-12
97-619	CLIP-ON GASKET	16 (406.400) LENGTH	Page 2-11, 2-12
97-620	CLIP-ON GASKET	16 (406.400) LENGTH	Page 2-11, 2-12
97-621	CLIP-ON GASKET	16 (406.400) LENGTH	Page 2-11, 2-12
97-622	CLIP-ON GASKET	16 (406.400) LENGTH	Page 2-11, 2-12
97-623	CLIP-ON GASKET	16 (406.400) LENGTH	Page 2-11, 2-12
97-624	CLIP-ON GASKET	16 (406.400) LENGTH	Page 2-11, 2-12
97-627	CLIP-ON GASKET	16 (406.400) LENGTH	Page 2-11, 2-12
97-628	CLIP-ON GASKET	16 (406.400) LENGTH	Page 2-11, 2-12
97-629	CLIP-ON GASKET	16 (406.400) LENGTH	Page 2-11, 2-12
97-630	CLIP-ON GASKET	16 (406.400) LENGTH	Page 2-11, 2-12
97-631	CLIP-ON GASKET	16 (406.400) LENGTH	Page 2-11, 2-12
97-632	CLIP-ON GASKET	16 (406.400) LENGTH	Page 2-11, 2-12
97-633	CLIP-ON GASKET	16 (406.400) LENGTH	Page 2-11, 2-12
97-634	CLIP-ON GASKET	16 (406.400) LENGTH	Page 2-11, 2-12
97-636	MINI CLIP-ON SYMMETRICAL SHIELDING GASKET	16.15 (410.210) LENGTH	Page 2-9
97-637	CLIP-ON SYMMETRICAL SHIELDING GASKET	16.5 (419.100) LENGTH	Page 2-9
97-640	CLIP-ON GASKET	16 (406.400) LENGTH	Page 2-11, 2-12
97-645	CLIP-ON GASKET	24 (609.600) LENGTH	Page 2-11, 2-12
97-646	CLIP-ON GASKET	24 (609.600) LENGTH	Page 2-11, 2-12
97-650	CLIP-ON GASKET	16 (406.400) LENGTH	Page 2-11, 2-12
97-654	DIVIDER EDGE SHIELD	12 (304.800) LENGTH	Page 2-18
97-655	CLIP-ON PERPENDICULAR GROUNDING STRIP	12 (304.800) LENGTH	Page 2-19
97-656	CLIP-ON PERPENDICULAR SHIELDING	16 (406.400) LENGTH	Page 2-19
97-723	DIN CONNECTOR SERIES		Page 3-3
97-725	DIN CONNECTOR SERIES		Page 3-3
97-727	FIBER OPTIC SHIELDING		Page 3-5
97-728	USB CONNECTOR GASKET		Page 3-3
97-768	"D" CONNECTOR SERIES	9 PIN STAINLESS STEEL	Page 3-2
97-769	"D" CONNECTOR SERIES	15 PIN STAINLESS STEEL	Page 3-2
97-770	"D" CONNECTOR SERIES	25 PIN STAINLESS STEEL	Page 3-2
97-771	"D" CONNECTOR SERIES	37 PIN STAINLESS STEEL	Page 3-2
97-772	"D" CONNECTOR SERIES	50 PIN STAINLESS STEEL	Page 3-2
97-773	"D" CONNECTOR SERIES	68 PIN STAINLESS STEEL	Page 3-2
97-778	"D" CONNECTOR SERIES	9 PIN BERYLLIUM COPPER	Page 3-2
97-779	"D" CONNECTOR SERIES	15 PIN BERYLLIUM COPPER	Page 3-2
97-780	"D" CONNECTOR SERIES	25 PIN BERYLLIUM COPPER	Page 3-2
97-781	"D" CONNECTOR SERIES	37 PIN BERYLLIUM COPPER	Page 3-2
97-782	"D" CONNECTOR SERIES	50 PIN BERYLLIUM COPPER	Page 3-2
97-783	"D" CONNECTOR SERIES	68 PIN BERYLLIUM COPPER	Page 3-2
97-786	IEEE 1394 HORIZONTAL CONNECTOR GASKET		Page 3-4
97-787	IEEE 1394 HORIZONTAL CONNECTOR GASKET		Page 3-4
97-822	SLOTTED "D" CONNECTOR SHIELDING	9 PIN STAINLESS STEEL	Page 3-2
97-823	SLOTTED "D" CONNECTOR SHIELDING	9 PIN STAINLESS STEEL	Page 3-2
97-824	SLOTTED "D" CONNECTOR SHIELDING	15 PIN STAINLESS STEEL	Page 3-2
97-825	SLOTTED "D" CONNECTOR SHIELDING	15 PIN STAINLESS STEEL	Page 3-2
97-826	SLOTTED "D" CONNECTOR SHIELDING	25 PIN STAINLESS STEEL	Page 3-2
97-827	SLOTTED "D" CONNECTOR SHIELDING	25 PIN STAINLESS STEEL	Page 3-2
97-828	SLOTTED "D" CONNECTOR SHIELDING	37 PIN STAINLESS STEEL	Page 3-2
97-910	SOLID TOP SYMMETRICAL SLOTTED SHIELDING	15 (381.000) LENGTH	Page 2-8

All dimensions shown are in inches (millimeters) unless otherwise specified.



PART NO.	PRODUCT	SIZE	PAGE NO.
97-913	SOLID TOP SYMMETRICAL SLOTTED SHIELDING	15 (381.000) LENGTH	Page 2-8
97-915	SOLID TOP SYMMETRICAL SLOTTED SHIELDING	15 (381.000) LENGTH	Page 2-8
97-916	SOLID TOP SYMMETRICAL SLOTTED SHIELDING	15 (381.000) LENGTH	Page 2-8
97-918	SOLID TOP SYMMETRICAL SLOTTED SHIELDING	15 (381.000) LENGTH	Page 2-8
97-919	SOLID TOP SYMMETRICAL SLOTTED SHIELDING	15 (381.000) LENGTH	Page 2-8
97-921	FLEXIBLE LOW COMPRESSION SERIES	24 (609.600) LENGTH	Page 2-15
97-941	FLEXIBLE LOW COMPRESSION SERIES	24 (609.600) LENGTH	Page 2-15
97-951	SYMMETRICAL SLOTTED SHIELDING	15 (381.000) LENGTH	Page 2-7
97-952	SYMMETRICAL SLOTTED SHIELDING	15 (381.000) LENGTH	Page 2-7
97-954	SYMMETRICAL SLOTTED SHIELDING	15 (381.000) LENGTH	Page 2-7
97-955	SYMMETRICAL SLOTTED SHIELDING	15 (381.000) LENGTH	Page 2-7
97-957	SYMMETRICAL SLOTTED SHIELDING	15 (381.000) LENGTH	Page 2-7
97-958	SYMMETRICAL SLOTTED SHIELDING	15 (381.000) LENGTH	Page 2-7
97-964	RETENTION CLIP		Page 2-8
97-965	RETENTION CLIP		Page 2-8
97-966	RETENTION CLIP		Page 2-8
97-972	DIVIDER EDGE SHIELD	12 (304.800) LENGTH	Page 2-18
97-973	CARD GUIDE CLIP-ON		Page 2-18
97-974	MINI-LONGITUDINAL GROUNDING GASKET	16 (406.400) LENGTH	Page 2-20
97-975	LONGITUDINAL GROUNDING SERIES	18.75 (476.250) LENGTH	Page 2-21
97-976	CLIP-ON LONGITUDINAL GROUNDING STRIP	17 (431.800) LENGTH	Page 2-20
97-983	CARD GUIDE CLIP-ON		Page 2-18
98-XXX	Most standard profiles are available in UltraSoft® low compression force (78 and 98) series. Please call our sales department for availability.		

All dimensions shown are in inches (millimeters) unless otherwise specified.

MOUNTING METHODS



UNIVERSAL MOUNTING

A stainless steel mounting track is available for use with our full line of gasketing materials. Its unique design offers a secure mounting option versatile enough for use with fingerstock, ElectroNit® mesh, ElectroSeal elastomers, UltraSoft® Knit and fabric-over-foam products.

PART NUMBER	WIDTH
0095-X996-00	0.310 (7.874)
0095-X997-00	0.430 (10.922)
0095-X998-00	0.600 (15.240)



UNIVERSAL MOUNT

MATERIAL THICKNESS
A = 0.030 (0.762)
B = 0.045 (1.143)
C = 0.060 (1.524)
D = 0.090 (2.286)
E = 0.150 (3.810)



To identify proper mounting track, select width and corresponding part number from the above chart. Replace the "X" with required material thickness.



MOUNTING METHODS

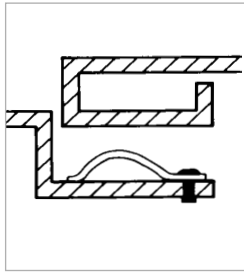

RIVET MOUNT

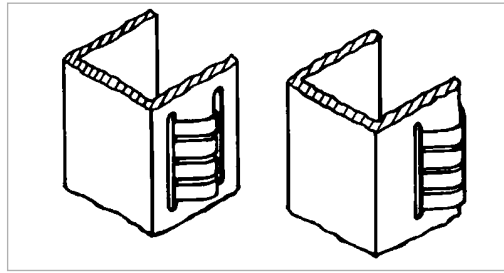

SLOT MOUNT



STICKY FINGERS®



CLIP-ON MOUNTING



TAPE TRACK MOUNTING

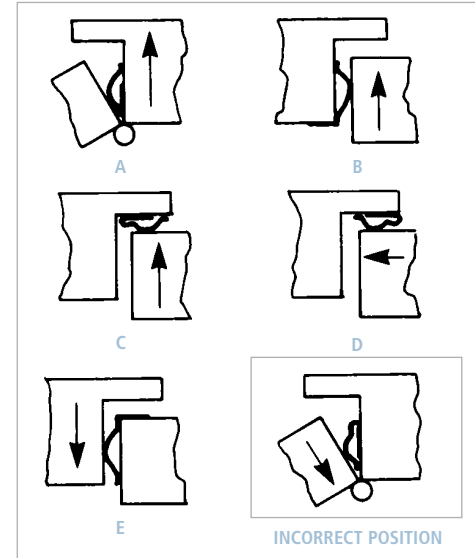

▲ Shielding gaskets may be mounted for either wiping or compression closing applications. Proper positioning of the shielding gasket must take into consideration the closing design and the configuration of the mounting surface.

Laird Technologies shielding devices may be mounted quickly and easily using any of several different methods. Each installation method is described in the text that follows. However, if you should run into a unique situation not resolved by any of these methods, give us a call. More than likely we can provide the exact answer you need.

RIVET MOUNT

Riveting produces a tight, long-lasting installation. Either plastic or metal rivets may be used.

SLOT MOUNT

Slot mounted parts are easily installed using slots where bi-directional movement is required. Simply install part into one slot and snap it into the second slot or over the edge of the frame.

ADHESIVE MOUNTING

Sticky Fingers® is an instant, pressure-sensitive adhesive bonding system, ideal for all-purpose contact strips for metal cabinets and electronic enclosures, and is unaffected by temperatures from -67 to +250°F (-55 to +121°C).

Simply follow these four easy steps:

1. Remove all grease and oily residue with solvent. Smooth the mounting surface with emery cloth.
2. Peel off protective paper backing.
3. Place gasket in correct position. (See mounting methods diagrams A through E.) Press firmly to ensure a good adhesive bond. Avoid repositioning, which might impair the effectiveness of the adhesive or may bend or kink the strip.
NOTE: On items where fingers cover the solid portion of the gasket, pressure may be applied by inserting a mandrel in the strip and pressing down. For contact strips with Magnefil® insert, simply press down on the fingers.
4. Allow 24 hours minimum curing time.

Standard parts are supplied with nonconductive tape. For rough surface applications, such as flame-sprayed surfaces, 0.010 in. (0.254 mm) thick nonconductive tape is recommended. Optional conductive tape is also available. Contact a sales department representative for additional ordering information.

CLIP-ON MOUNTING

Clip-on gaskets hold firmly in place due to their own spring characteristics. Simply push the strips onto the edge or flange of the door or enclosure. Also available are clip-on gaskets with either "T" or "D" lances.

TAPE TRACK MOUNTING

Stainless Steel mounting track with PSA (pressure sensitive adhesive) is available on the Symmetrical Slotted Series and Slot Mount Series.

WELDING

Welded mounting requires simple, traditional welding techniques.

SOLDERING

Solder mounting requires normal low temperature soldering techniques, including cleaning and fluxing of parts with common copper flux materials.



PART NUMBER FORMAT:

Example:

Stock Item **Unique Part No.** **Finish I.D.**
0 0 9 7 — 0 5 2 0 — 0 2

- In the above example, Laird Technologies part number 0097-0520-02 is a 97-520 RFI/EMI shielding gasket with a bright finish
- When ordering UltraSoft® items, the stock item prefix will be 0098 or 0078. The above example in UltraSoft would be 0098-0520-02.
- When ordering coil, the prefix 0C should precede the stock item number; for example: 0C97, 0C98, 0C77 or 0C78
- When ordering stainless steel items, the stock item prefix will be 0095
- Standard plating finish is 0.0001 in. (0.0025 mm) min. [gold 0.00005 in. (0.0013 mm) min.] but can be varied to meet your custom needs
- Modifications to standard parts are specified by an X (following finish I.D.) for quoting only. Upon ordering, a specific part number will be assigned.
- For tape options, see Adhesive Mounting — Sticky Fingers® on page 1-10
- Use the catalog number for the unique part number and refer to the following chart for finish I.D.

PLATING FINISHES

REQUIRED FINISH	FINISH	SPECIFICATIONS	I.D. #
Bright Finish	—	—	02
Solderable Unplated	—	—	21
Gold	Gold	ASTM B-488/SAE AMS 2422	03
	Nickel Underplate	QQ-N-290 / ASTM B-488	10
	Gold Contips®	ASTM B-488/SAE AMS 2422	13
	Gold Contips / Gold Plate	ASTM B-488 / SAE AMS 2422	14
Silver	Silver	ASTM B-700	04
	Silver Contips	ASTM B-700	11
	Silver Contips / Plating	ASTM B-700	12
	Silver Plate / Gold Contips	ASTM B-700/ASTM B-488	20
Cadmium	Yellow Chromate	QQ-P-416	05
	Clear Chromate	QQ-P-416	06
Tin Lead*	Solder	SAE AMS-P-81728	07
Nickel	Dull	QQ-N-290	09
	Bright	QQ-N-290	19
	Engineering (Sulfamate)	SAE AMS 2424	24
Electroless Nickel	Mid Phos Electroless Nickel	MIL-C-26074	18
Tin	Satin	ASTM B-545	08
	Bright	ASTM B-545	17
Zinc	Yellow Chromate	SAE AMS 2402	16
	Clear Chromate	SAE AMS 2402	15
Rhodium	Rhodium	ASTM B-634	22
Stainless Steel	Passivation	SAE AMS QQ-P-35	—

*Not recommended for Foldover Series. Note: Refer to page 5-2 for Metals Galvanic Compatibility Chart.



Laird Technologies' Slot Mount Series of beryllium copper shielding gaskets is designed for use in a wide variety of slotted applications. This economical product line is ideal for both grounding and shielding applications.

- Minimal slot fabrication cost
- Easy and cost-effective installation since fasteners and adhesives are not required
- Bi-directional wiping and compression action to accommodate a wide variety of designs
- Ideal for grounding and shielding in the following electronic enclosure applications:
 - Front panel handles
 - Chassis covers
 - Plug-in units
 - Backplanes
 - Subrack assemblies
- Standard (77-Series) and UltraSoft® (78-Series low compression versions) are also supplied in 25.0 ft. (7.6 m) coils

The Slot Mount Series is available in your choice of finishes, see page 1-11. For load/deflection data, see page 2-33.

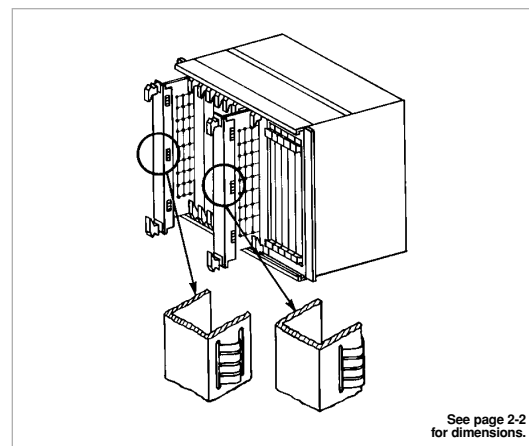
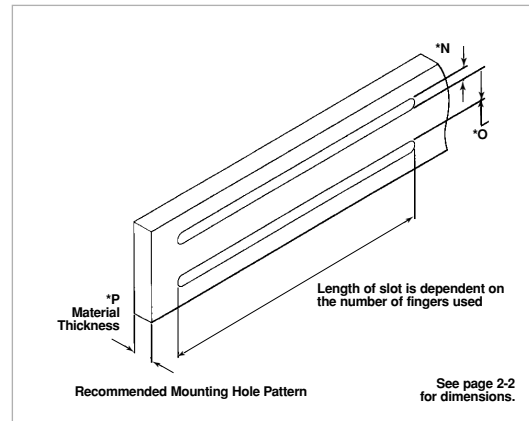

Slot Mount Series are available with Universal and Tape Track mounting options, see page 1-9, 1-10.

FINGERSTOCK GASKETS AND METAL GROUNDING PRODUCTS

SLOT MOUNT SERIES



SLOT MOUNT SERIES DIMENSIONS

SERIES	A	B	C	D	E	H	M	RECOMMENDED				Q (R)	LENGTH APPROX.	# OF FING.
								*N	*O	*P	Q			
77-010	0.320 (8.128)	0.110 (2.794)	0.004 (0.102)	0.187 (4.750)	0.018 (0.457)	0.085 (2.159)	0.110 (2.794)	0.090 (2.286)	0.260 (6.604)	0.040 (1.016)	0.020 (0.508)	16.000 (406.400)	86	—
77-011	0.600 (15.240)	0.220 (5.588)	0.005 (0.127)	0.282 (7.163)	0.032 (0.813)	0.140 (3.556)	0.180 (4.572)	0.140 (3.556)	0.520 (13.208)	0.070 (1.778)	0.040 (1.016)	16.000 (406.400)	57	—
77-015	0.600 (15.240)	0.220 (5.588)	0.005 (0.127)	N/A	N/A	0.140 (3.556)	0.180 (4.572)	0.140 (3.556)	0.520 (13.208)	0.070 (1.778)	0.040 (1.016)	0.250 (6.350)	1	—
77-016	0.320 (8.128)	0.110 (2.794)	0.004 (0.102)	N/A	N/A	0.085 (2.159)	0.110 (2.794)	0.090 (2.286)	0.260 (6.604)	0.040 (1.016)	0.020 (0.508)	0.169 (4.293)	1	—
77-017	0.320 (8.128)	0.110 (2.794)	0.004 (0.102)	0.187 (4.750)	0.018 (0.457)	0.085 (2.159)	0.110 (2.794)	0.090 (2.286)	0.260 (6.604)	0.040 (1.016)	0.020 (0.508)	0.356 (9.042)	2	—
77-018	0.320 (8.128)	0.110 (2.794)	0.004 (0.102)	0.187 (4.750)	0.018 (0.457)	0.085 (2.159)	0.110 (2.794)	0.090 (2.286)	0.260 (6.604)	0.040 (1.016)	0.020 (0.508)	0.543 (13.792)	3	—
77-019	0.320 (8.128)	0.110 (2.794)	0.004 (0.102)	0.187 (4.750)	0.018 (0.457)	0.085 (2.159)	0.110 (2.794)	0.090 (2.286)	0.260 (6.604)	0.040 (1.016)	0.020 (0.508)	0.730 (18.542)	4	—
77-020	0.600 (15.240)	0.220 (5.588)	0.005 (0.127)	0.282 (7.163)	0.032 (0.813)	0.140 (3.556)	0.180 (4.572)	0.140 (3.556)	0.520 (13.208)	0.070 (1.778)	0.040 (1.016)	0.532 (13.513)	2	—
77-021	0.320 (8.128)	0.110 (2.794)	0.004 (0.102)	0.187 (4.750)	0.018 (0.457)	0.085 (2.159)	0.110 (2.794)	0.090 (2.286)	0.260 (6.604)	0.060 (1.524)	0.035 (0.889)	16.000 (406.400)	86	—
77-023	0.370 (9.398)	0.130 (3.302)	0.004 (0.102)	N/A	N/A	0.085 (2.159)	0.110 (2.794)	0.090 (2.286)	0.300 (7.620)	0.040 (1.016)	0.020 (0.508)	0.225 (5.715)	1	—
77-024	0.370 (9.398)	0.130 (3.302)	0.004 (0.102)	0.250 (6.350)	0.025 (0.635)	0.085 (2.159)	0.110 (2.794)	0.090 (2.286)	0.300 (7.620)	0.040 (1.016)	0.020 (0.508)	0.475 (12.065)	2	—
77-025	0.370 (9.398)	0.130 (3.302)	0.004 (0.102)	0.250 (6.350)	0.025 (0.635)	0.085 (2.159)	0.110 (2.794)	0.090 (2.286)	0.300 (7.620)	0.040 (1.016)	0.020 (0.508)	0.725 (18.415)	3	—
77-026	0.370 (9.398)	0.130 (3.302)	0.005 (0.127)	0.250 (6.350)	0.025 (0.635)	0.085 (2.159)	0.110 (2.794)	0.090 (2.286)	0.300 (7.620)	0.040 (1.016)	0.020 (0.508)	0.975 (24.765)	4	—
77-027	0.370 (9.398)	0.130 (3.302)	0.005 (0.127)	0.250 (6.350)	0.025 (0.635)	0.085 (2.159)	0.110 (2.794)	0.090 (2.286)	0.300 (7.620)	0.040 (1.016)	0.020 (0.508)	1.225 (31.115)	5	—
77-028	0.370 (9.398)	0.130 (3.302)	0.005 (0.127)	0.250 (6.350)	0.025 (0.635)	0.085 (2.159)	0.110 (2.794)	0.090 (2.286)	0.300 (7.620)	0.040 (1.016)	0.020 (0.508)	1.475 (37.465)	6	—
77-029	0.800 (20.320)	0.320 (8.128)	0.004 (0.102)	N/A	N/A	0.200 (5.080)	0.180 (4.572)	0.220 (5.588)	0.720 (18.288)	0.070 (1.778)	0.040 (1.016)	0.343 (8.712)	1	—
77-030	0.800 (20.320)	0.320 (8.128)	0.004 (0.102)	0.375 (9.525)	0.032 (0.813)	0.200 (5.080)	0.180 (4.572)	0.220 (5.588)	0.720 (18.288)	0.070 (1.778)	0.040 (1.016)	0.718 (18.237)	2	—
77-031	0.800 (20.320)	0.320 (8.128)	0.005 (0.127)	0.375 (9.525)	0.032 (0.813)	0.200 (5.080)	0.180 (4.572)	0.220 (5.588)	0.720 (18.288)	0.070 (1.778)	0.040 (1.016)	1.093 (27.762)	3	—
77-032	0.800 (20.320)	0.320 (8.128)	0.005 (0.127)	0.375 (9.525)	0.032 (0.813)	0.200 (5.080)	0.180 (4.572)	0.220 (5.588)	0.720 (18.288)	0.070 (1.778)	0.040 (1.016)	1.468 (37.287)	4	—
77-035	0.310 (7.874)	0.120 (3.048)	0.003 (0.076)	0.250 (6.350)	0.020 (0.508)	0.090 (2.286)	0.115 (2.921)	0.095 (2.413)	0.250 (6.350)	0.040 (1.016)	0.015 (0.381)	0.480 (12.192)	2	—
77-036	0.310 (7.874)	0.120 (3.048)	0.003 (0.076)	0.250 (6.350)	0.020 (0.508)	0.090 (2.286)	0.115 (2.921)	0.095 (2.413)	0.250 (6.350)	0.040 (1.016)	0.015 (0.381)	0.980 (24.892)	4	—
77-037	0.310 (7.874)	0.120 (3.048)	0.003 (0.076)	0.250 (6.350)	0.020 (0.508)	0.090 (2.286)	0.115 (2.921)	0.095 (2.413)	0.250 (6.350)	0.040 (1.016)	0.015 (0.381)	1.480 (37.592)	6	—
77-038	0.310 (7.874)	0.120 (3.048)	0.003 (0.076)	0.250 (6.350)	0.020 (0.508)	0.090 (2.286)	0.115 (2.921)	0.095 (2.413)	0.250 (6.350)	0.040 (1.016)	0.015 (0.381)	1.980 (50.292)	8	—
77-039	0.280 (7.112)	0.110 (2.794)	0.002 (0.051)	N/A	N/A	0.075 (1.905)	0.110 (2.794)	0.090 (2.286)	0.220 (5.588)	0.040 (1.016)	0.030 (0.762)	0.169 (4.293)	1	—
77-040	0.280 (7.112)	0.110 (2.794)	0.002 (0.051)	0.187 (4.750)	0.018 (0.457)	0.075 (1.905)	0.110 (2.794)	0.090 (2.286)	0.220 (5.588)	0.040 (1.016)	0.030 (0.762)	0.356 (9.042)	2	—
77-041	0.280 (7.112)	0.110 (2.794)	0.002 (0.051)	0.187 (4.750)	0.018 (0.457)	0.075 (1.905)	0.110 (2.794)	0.090 (2.286)	0.220 (5.588)	0.040 (1.016)	0.030 (0.762)	0.543 (13.792)	3	—
77-042	0.280 (7.112)	0.110 (2.794)	0.002 (0.051)	0.187 (4.750)	0.018 (0.457)	0.075 (1.905)	0.110 (2.794)	0.090 (2.286)	0.220 (5.588)	0.040 (1.016)	0.030 (0.762)	0.730 (18.542)	4	—
77-044	0.320 (8.128)	0.110 (2.794)	0.004 (0.102)	0.187 (4.750)	0.018 (0.457)	0.085 (2.159)	0.110 (2.794)	0.090 (2.286)	0.260 (6.604)	0.040 (1.016)	0.020 (0.508)	1.104 (28.042)	6	—
77-045	0.320 (8.128)	0.110 (2.794)	0.004 (0.102)	N/A	N/A	0.085 (2.159)	0.110 (2.794)	0.090 (2.286)	0.260 (6.604)	0.040 (1.016)	0.020 (0.508)	16.000 (406.400)	86	—
77-046	0.320 (8.128)	0.110 (2.794)	0.004 (0.102)	0.187 (4.750)	0.018 (0.457)	0.085 (2.159)	0.110 (2.794)	0.090 (2.286)	0.260 (6.604)	0.060 (1.524)	0.040 (1.016)	0.356 (9.042)	2	—
77-047	0.320 (8.128)	0.110 (2.794)	0.004 (0.102)	0.187 (4.750)	0.018 (0.457)	0.085 (2.159)	0.110 (2.794)	0.090 (2.286)	0.260 (6.604)	0.060 (1.524)	0.040 (1.016)	0.543 (13.792)	3	—
77-048	0.320 (8.128)	0.110 (2.794)	0.004 (0.102)	0.187 (4.750)	0.018 (0.457)	0.085 (2.159)	0.110 (2.794)	0.090 (2.286)	0.260 (6.604)	0.060 (1.524)	0.040 (1.016)	0.730 (18.542)	4	—
77-050	0.320 (8.128)	0.110 (2.794)	0.004 (0.102)	0.187 (4.750)	0.018 (0.457)	0.085 (2.159)	0.110 (2.794)	0.090 (2.286)	0.260 (6.604)	0.060 (1.524)	0.040 (1.016)	0.917 (23.292)	5	—
77-051	0.320 (8.128)	0.110 (2.794)	0.004 (0.102)	0.187 (4.750)	0.018 (0.457)	0.085 (2.159)	0.110 (2.794)	0.090 (2.286)	0.260 (6.604)	0.060 (1.524)	0.040 (1.016)	1.104 (28.042)	6	—
77-052	0.320 (8.128)	0.110 (2.794)	0.004 (0.102)	0.187 (4.750)	0.018 (0.457)	0.085 (2.159)	0.110 (2.794)	0.090 (2.286)	0.260 (6.604)	0.060 (1.524)	0.040 (1.016)	1.291 (32.791)	7	—
77-053	0.320 (8.128)	0.110 (2.794)	0.004 (0.102)	0.187 (4.750)	0.018 (0.457)	0.085 (2.159)	0.110 (2.794)	0.090 (2.286)	0.260 (6.604)	0.060 (1.524)	0.040 (1.016)	1.478 (37.541)	8	—
77-054	0.320 (8.128)	0.110 (2.794)	0.004 (0.102)	0.187 (4.750)	0.018 (0.457)	0.085 (2.159)	0.110 (2.794)	0.090 (2.286)	0.260 (6.604)	0.060 (1.524)	0.040 (1.016)	1.665 (42.291)	9	—
77-055	0.320 (8.128)	0.110 (2.794)	0.004 (0.102)	0.187 (4.750)	0.018 (0.457)	0.085 (2.159)	0.110 (2.794)	0.090 (2.286)	0.260 (6.604)	0.060 (1.524)	0.040 (1.016)	1.852 (47.041)	10	—
77-058	0.320 (8.128)	0.110 (2.794)	0.004 (0.102)	0.187 (4.750)	0.018 (0.457)	0.085 (2.159)	0.110 (2.794)	0.090 (2.286)	0.260 (6.604)	0.060 (1.524)	0.020 (0.508)	0.917 (23.292)	5	—
77-059	0.370 (9.398)	0.130 (3.302)	0.004 (0.102)	0.250 (6.350)	0.025 (0.635)	0.085 (2.159)	0.110 (2.794)	0.090 (2.286)	0.310 (7.874)	0.040 (1.016)	0.020 (0.508)	16.000 (406.400)	64	—
77-062	0.320 (8.128)	0.110 (2.794)	0.004 (0.102)	0.187 (4.750)	0.018 (0.457)	0.085 (2.159)	0.110 (2.794)	0.090 (2.286)	0.260 (6.604)	0.048 (1.219)	0.025 (0.635)	0.169 (4.293)	1	—
77-063	0.320 (8.128)	0.110 (2.794)	0.004 (0.102)	0.187 (4.750)	0.018 (0.457)	0.085 (2.159)	0.110 (2.794)	0.090 (2.286)	0.260 (6.604)	0.048 (1.219)	0.025 (0.635)	0.356 (9.042)	2	—
77-064	0.320 (8.128)	0.110 (2.794)	0.004 (0.102)	0.187 (4.750)	0.018 (0.457)	0.085 (2.159)	0.110 (2.794)	0.090 (2.286)	0.260 (6.604)	0.048 (1.219)	0.025 (0.635)	0.543 (13.792)	3	—
77-065	0.320 (8.128)	0.110 (2.794)	0.004 (0.102)	0.187 (4.750)	0.018 (0.457)	0.085 (2.159)	0.110 (2.794)	0.090 (2.286)	0.260 (6.604)	0.048 (1.219)	0.025 (0.635)	0.730 (18.542)	4	—
77-070	0.320 (8.128)	0.110 (2.794)	0.004 (0.102)	0.187 (4.750)	0.018 (0.457)	0.085 (2.159)	0.110 (2.794)	0.090 (2.286)	0.260 (6.604)	0.062 (1.575)	0.035 (0.889)	16.000 (406.400)	86	—
77-076	0.600 (15.240)	0.220 (5.588)	0.005 (0.127)	N/A	N/A	0.140 (3.556)	0.180 (4.572)	0.140 (3.556)	0.520 (13.208)	0.070 (1.778)	0.020 (0.508)	0.340 (8.636)	1	—
77-087	0.563 (14.300)	0.110 (2.794)	0.003 (0.076)	0.187 (4.750)	0.018 (



Dual slot mount parts are available for a variety of slotted applications. The dual slot feature optimizes the compression force and provides a good operating range. This product is ideal for both shielding and grounding applications. The bi-directional wiping and compression action accommodates a wide variety of designs. Ideal for use in the grounding and shielding of front panel handles, sub rack assemblies, plug-in units, back planes and other electronic enclosure applications.



DUAL SLOT SERIES DIMENSIONS

SERIES	A	B	C	D	E	H	M	N	O	P	Q	LENGTH APPROX.	# OF FING.
77-075	0.325 (8.255)	0.100 (2.54)	0.003 (0.076)	0.187 (4.750)	0.018 (0.457)	0.085 (2.159)	0.110 (2.794)	0.090 (2.286)	0.260 (6.604)	0.040 (1.016)	0.020 (0.508)	16.000 (406.400)	86 —
77-093	0.325 (8.255)	0.140 (3.556)	0.003 (0.076)	0.187 (4.750)	0.018 (0.457)	0.085 (2.159)	0.110 (2.794)	0.090 (2.286)	0.260 (6.604)	0.040 (1.016)	0.020 (0.508)	16.000 (406.400)	86 —
77-110	0.325 (8.255)	0.125 (3.175)	0.003 (0.076)	0.187 (4.750)	0.018 (0.457)	0.085 (2.159)	0.110 (2.794)	0.090 (2.286)	0.260 (6.604)	0.040 (1.016)	0.020 (0.508)	16.000 (406.400)	86 —



All dimensions shown are in inches (millimeters) unless otherwise specified.



Laird Technologies offers a unique product designed to shield the front panels of IEEE standard 1101.10 card cages, commonly referred to as Dot-10, called the Compact PCI gasket.

This front panel shielding has been designed to shield between the front panels on sub racks and plug-in units. This is a beryllium copper solid top symmetrical slotted fingerstock strip pre-plated in sulfamate nickel. It is designed to mount on the "T" shape on a front panel extrusion (see below). Specially designed for wiping applications, this configuration allows total symmetrical compression action with bi-directional engagement.

Standard size shown is based on the 9.5" (241.300) length per the Dot-10 standard. Other lengths and plating finishes are available for your specific application.



Laird Technologies alternating slot/cut design is designed for use in a wide variety of slotted applications, such as front panel handles, plug-in units, subrack assemblies, chassis covers and backplanes.

The alternating slot /cut design serves to enhance the gasket strength, while providing enough flexibility to allow the part to be folded in half with no resultant finger damage. This is especially significant in during installation or repair.

Available in a wide variety of plating finishes to meet galvanic compatibility requirements.

Available in UltraSoft™, low compression series (-078).



All dimensions shown are in inches (millimeters) unless otherwise specified.

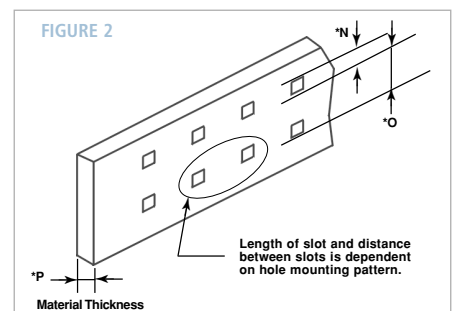

FIGURE 1: REPEATING FINGER PATTERN



Laird Technologies introduces Variable Slot Mount shielding, which eliminates the use of long slots while still utilizing the easy installation method of slot mount shielding. Fingers are removed from the strip in areas where a mounting slot is not present. The Variable Slot Mount shielding strips can be customized to any patterned series of slots.

- Easy and cost-effective installation since fasteners and adhesives are not required
- Improved shielding effectiveness compared to traditional slot mount series through elimination of long slots in host material
- Slot mounting feature can be varied to accommodate different lengths and hole mounting patterns (see figure 2)
- Three and five pitch segments ideal for grounding applications
- Bi-directional wiping and compression action to accommodate a wide variety of designs
- Available in standard (77-Series) and UltraSoft® (78-Series low compression versions)
- Ability to retrofit equipment when higher clock speeds limit current slot mount product without changing slot size or location
- One piece construction eliminates handling individual pieces, thereby shortening installation time
- Ideal for grounding and shielding in the following electronic enclosure applications:
 - Front panel handles
 - Chassis covers
 - Backplanes
 - Plug-in units
 - Subrack assemblies



VARIABLE SLOT MOUNT DIMENSIONS

SERIES VIEW**	A	B	C	D	E	H	M	*N RECOMMENDED	*O	*P	Q (R)	LENGTH APPROX.	# OF FING.
77-056 A	0.320 (8.128)	0.110 (2.794)	0.004 (0.102)	0.187 (4.750)	0.018 (0.457)	0.085 (2.159)	0.110 (2.794)	0.090 (2.286)	0.260 (6.604)	0.040 (1.016)	0.020 (0.508)	16.000 (406.400)	86
77-057 A	0.600 (15.240)	0.220 (5.588)	0.005 (0.127)	0.282 (7.163)	0.032 (0.813)	0.130 (3.302)	0.180 (4.572)	0.140 (3.556)	0.520 (13.208)	0.070 (1.778)	0.040 (1.016)	16.000 (406.400)	57
77-060 E	0.320 (8.128)	0.110 (2.794)	0.003 (0.076)	0.187 (4.750)	0.018 (0.457)	0.085 (2.159)	0.110 (2.794)	0.090 (2.286)	0.260 (6.604)	0.040 (1.016)	0.020 (0.508)	16.000 (406.400)	86
77-061 B	0.320 (8.128)	0.110 (2.794)	0.003 (0.076)	0.187 (4.750)	0.018 (0.457)	0.085 (2.159)	0.110 (2.794)	0.090 (2.286)	0.260 (6.604)	0.040 (1.016)	0.020 (0.508)	16.000 (406.400)	86
77-066 C	0.320 (8.128)	0.110 (2.794)	0.003 (0.076)	0.187 (4.750)	0.018 (0.457)	0.085 (2.159)	0.110 (2.794)	0.090 (2.286)	0.260 (6.604)	0.040 (1.016)	0.020 (0.508)	16.000 (406.400)	86

SERIES VIEW**	A	B	C	D	E	H	M	*N RECOMMENDED	*O	*P	Q (R)	LENGTH APPROX.	# OF FING.
77-090 B	0.600 (15.240)	0.220 (5.588)	0.005 (0.127)	0.282 (7.163)	0.032 (0.813)	0.140 (3.556)	0.180 (4.572)	0.140 (3.556)	0.520 (13.208)	0.070 (1.778)	0.040 (1.016)	16.000 (406.400)	57
77-105 C	0.600 (15.240)	0.220 (5.588)	0.005 (0.127)	0.282 (7.163)	0.032 (0.813)	0.140 (3.556)	0.180 (4.572)	0.140 (3.556)	0.520 (13.208)	0.070 (1.778)	0.040 (1.016)	16.000 (406.400)	57
77-106 D	0.600 (15.240)	0.220 (5.588)	0.005 (0.127)	0.282 (7.163)	0.032 (0.813)	0.140 (3.556)	0.180 (4.572)	0.140 (3.556)	0.520 (13.208)	0.070 (1.778)	0.040 (1.016)	16.000 (406.400)	57
77-107 E	0.600 (15.240)	0.220 (5.588)	0.005 (0.127)	0.282 (7.163)	0.032 (0.813)	0.140 (3.556)	0.180 (4.572)	0.140 (3.556)	0.520 (13.208)	0.070 (1.778)	0.040 (1.016)	16.000 (406.400)	57

* May vary depending upon application.
 ** See Figure 1 for finger patterns.



Part No. 77-079, 83, 84, 85, 86, 91, 92



Part No. 77-012, 14, 33, 78, 81, 82

Laird Technologies No Snag Series shielding gaskets offer the designer a low compression, no snag design. Provided with Sticky Fingers® self-adhesive tape, these beryllium copper shielding gaskets provide easy and secure mounting.

- Shielding effectiveness of > 100 db (77-012) and 80 dB (77-014) for a 100 MHz plane wave
- Easy, cost-effective installation since fasteners are not required
- Ideal as an all-purpose contact strip for metal cabinets and electronic enclosures
- Available in a wide variety of plated finishes, see page 1-11
- Supplied in standard 24.000 in. (609.600 mm) lengths or other specified lengths

For load/deflection data, see page 2-33.

NO SNAG GASKET DIMENSIONS

SERIES	A	B	C	D	E	H	M	RADIUS	APPROX. LENGTH
77-012	0.320 (8.128)	0.110 (2.794)	0.002 (0.051)	0.187 (4.750)	0.018 (0.457)	0.210 (5.334)	0.110 (2.794)	0.110 (2.794)	24.000 (609.600)
* 77-014	0.600 (15.240)	0.220 (5.588)	0.004 (0.102)	0.375 (9.525)	0.032 (0.813)	0.280 (7.112)	0.180 (4.572)	0.180 (4.572)	24.000 (609.600)
77-033	0.370 (9.398)	0.130 (3.302)	0.002 (0.051)	0.250 (6.350)	0.025 (0.635)	0.210 (5.334)	0.110 (2.794)	0.110 (2.794)	16.000 (406.400)
* 77-078	0.800 (20.320)	0.320 (8.128)	0.004 (0.102)	0.375 (9.525)	0.032 (0.813)	0.440 (11.176)	0.190 (4.826)	0.190 (4.826)	24.000 (609.600)
* 77-079	0.320 (8.128)	0.100 (2.540)	0.035 (0.889)	0.156 (3.962)	0.018 (0.457)	0.210 (5.334)	0.100 (2.540)	0.100 (2.540)	16.000 (406.400)
77-081	0.280 (7.112)	0.110 (2.794)	0.002 (0.051)	0.187 (4.750)	0.018 (0.457)	0.180 (4.572)	0.100 (2.540)	0.100 (2.540)	24.000 (609.600)
* 77-082	1.100 (27.940)	0.400 (10.160)	0.005 (0.127)	0.500 (12.700)	0.040 (1.016)	0.780 (19.812)	0.420 (10.668)	0.420 (10.668)	24.000 (609.600)
* 77-083	0.370 (9.398)	0.130 (3.302)	0.004 (0.102)	0.125 (3.175)	0.025 (0.635)	0.100 (2.540)	0.202 (5.131)	0.202 (5.131)	16.000 (406.400)
* 77-084	0.370 (9.398)	0.130 (3.302)	0.004 (0.102)	0.250 (6.350)	0.025 (0.635)	0.100 (2.540)	0.202 (5.131)	0.202 (5.131)	16.000 (406.400)
* 77-085	0.600 (15.240)	0.220 (5.588)	0.004 (0.102)	0.375 (9.525)	0.032 (0.813)	0.150 (3.810)	0.295 (7.493)	0.295 (7.493)	18.000 (457.200)
* 77-086	0.320 (8.128)	0.090 (2.286)	0.003 (0.762)	0.187 (4.750)	0.018 (0.457)	0.210 (5.334)	0.100 (2.540)	0.100 (2.540)	16.000 (406.400)
* 77-091	0.600 (15.240)	0.220 (5.588)	0.004 (0.102)	0.375 (9.525)	0.032 (0.813)	0.780 (19.812)	0.150 (3.810)	0.150 (3.810)	18.000 (457.200)
* 77-092	0.600 (15.240)	0.220 (5.588)	0.004 (0.102)	0.187 (4.750)	0.032 (0.813)	0.295 (7.493)	0.150 (3.810)	0.150 (3.810)	18.000 (457.200)

* Available in UltraSoft® low compression version as -78.



All dimensions shown are in inches (millimeters) unless otherwise specified.



Strips with Sticky Fingers® and Rivet Mounts exhibit typical attenuation >100 dB for a 100 MHz plane wave.



WITH STICKY FINGERS

Series 97-951/954/957 are low compression, adhesive-mounted beryllium copper shielding strips. Designed as a continuous band, the strip is slotted to permit spring contact throughout its length. A wide radius profile creates

the greatest contact for maximum conductivity with minimum compression requirements. As with all Sticky Fingers shielding strips, a self-adhesive tape makes mounting easy and secure. All are available in your choice of finishes, see page 1-11. For load/deflection data, see page 2-33.

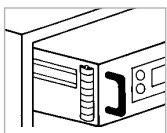

WITH BI-DIRECTIONAL RIVET MOUNT

Series 97-952/955/958 are as described above, but with the addition of an integral pierced brass track to provide plastic push rivet mounting in a 0.125 in. (3.175 mm) diameter hole.

Designed especially for slide applications, this configuration allows total symmetrical compression action with bi-directional engagement. It is recommended for high temperature and/or extremely high side load situations, such as PC board connections and electronic drawers. All are available in your choice of finishes, see page 1-11. For load/deflection data, see page 2-33. Both are available in UltraSoft® low compression force 98-Series.

S³ SERIES

SERIES	A	B	C	D
95-901	0.284 (7.214)	0.020 (0.508)	0.010 (0.254)	0.068 (1.727)
95-902	0.325 (8.255)	0.030 (0.762)	0.010 (0.254)	0.080 (2.032)



All dimensions shown are in inches (millimeters) unless otherwise specified.

S³ SERIES — STICKY FINGERS

SERIES	A MIN.	B	C	D	E	K	L	APPROX. LENGTH
97-951	0.620 (15.748)	0.220 (5.588)	0.004 (0.102)	0.375 (9.525)	0.030 (0.762)	0.760 (19.304)	0.100 (2.540)	15.000 (381.000)
97-954	0.450 (11.430)	0.140 (3.556)	0.003 (0.076)	0.250 (6.350)	0.022 (0.559)	0.510 (12.954)	0.070 (1.778)	15.000 (381.000)
97-957	0.350 (8.890)	0.110 (2.794)	0.003 (0.076)	0.187 (4.750)	0.018 (0.457)	0.380 (9.652)	0.055 (1.397)	15.000 (381.000)

S³ SERIES — RIVET MOUNT

SERIES	A	B MIN.	C	D	E	K	L	APPROX. LENGTH	M	N	NO. OF RIVETS
97-952	0.620 (15.748)	0.220 (5.588)	0.004 (0.102)	0.375 (9.525)	0.030 (0.762)	0.760 (19.304)	0.100 (2.540)	15.000 (381.000)	0.560 (14.224)	0.940 (23.876)	10 —
97-955	0.450 (11.430)	0.140 (3.556)	0.003 (0.076)	0.250 (6.350)	0.022 (0.559)	0.510 (12.954)	0.070 (1.778)	15.000 (381.000)	0.630 (16.002)	0.880 (22.352)	10 —
97-958	0.350 (8.890)	0.110 (2.794)	0.003 (0.076)	0.187 (4.750)	0.018 (0.457)	0.380 (9.652)	0.070 (1.778)	15.000 (381.000)	0.660 (16.764)	0.840 (21.336)	10 —



2 rivet types are available. Consult sales for more information.



Laird Technologies offers their Solid Top Symmetrical Slotted Shielding Gaskets. This product is uniquely designed for those applications where a lid or cover is closed using a sliding motion to complete the closure. The solid top design allows the cover to slide either perpendicularly or parallel to the fingerstock without snagging or damaging the gasket.

The newly designed symmetrical shielding offers all the advantages of our S³ series, having a large radius for maximum conductivity with minimum compression forces.

- Solid top provides an additional 10 dB of shielding effectiveness
- Offered in both rivet mount and tape mount versions
- Available with two types of rivets
- Generous radii provide maximum conductivity with minimum compression forces
- Parts can be modified and/or cut to any specific length
- For longitudinal sliding applications, a retention clip is recommended for secure mounting
- Available in standard or UltraSoft® (part numbers beginning with -98) versions



SOLID TOP S³ SERIES - STICKY FINGERS

SERIES	A MIN.	B	C	D	E	K	L	APPROX. LENGTH
97-910	0.620 (15.748)	0.220 (5.588)	0.004 (0.102)	0.375 (9.525)	0.030 (0.762)	0.760 (19.304)	0.100 (2.540)	15.000 (381.000)
97-915	0.450 (11.430)	0.140 (3.556)	0.003 (0.076)	0.250 (6.350)	0.022 (0.559)	0.510 (12.954)	0.070 (1.778)	15.000 (381.000)
97-918	0.350 (8.890)	0.110 (2.794)	0.003 (0.076)	0.187 (4.750)	0.018 (0.457)	0.380 (9.652)	0.070 (1.778)	15.000 (381.000)

SOLID TOP S³ SERIES - RIVET MOUNT

SERIES	A MIN.	B	C	D	E	K	L	APPROX. LENGTH	M	N	NO. OF RIVETS
97-913	0.620 (15.748)	0.220 (5.588)	0.004 (0.102)	0.375 (9.525)	0.030 (0.762)	0.760 (19.304)	0.100 (2.540)	15.000 (381.000)	0.560 (14.224)	0.940 (23.876)	10
97-916	0.450 (11.430)	0.140 (3.556)	0.003 (0.076)	0.250 (6.350)	0.022 (0.559)	0.510 (12.954)	0.070 (1.778)	15.000 (381.000)	0.630 (16.002)	0.880 (22.352)	10
97-919	0.350 (8.890)	0.110 (2.794)	0.003 (0.076)	0.187 (4.750)	0.018 (0.457)	0.380 (9.652)	0.070 (1.778)	15.000 (381.000)	0.660 (16.764)	0.840 (21.336)	10



View A - Computer tower side panel is moved sideways during the first step of installation.



View B - Next, the panel is moved downwards, sliding longitudinally on the vertical finger gasket.



View C - Fully installed panel is now compressing both finger gaskets.

RETENTION CLIP	PART NO.	RIVET MOUNT PART NO.
97-964	Used On	97-919
97-965	Used On	97-916
97-966	Used On	97-913

SOLID TOP S³ TRANSFER IMPEDANCE



All dimensions shown are in inches (millimeters) unless otherwise specified.

RETENTION CLIP

The above picture shows our Solid Top S³ with a retention clip. This clip is designed to ensure secure retention of actual fingerstock to track component.



Laird Technologies has designed a new clip-on shielding gasket for applications where bi-directional engagement is required. The 97-636 and 97-637 Clip-On Symmetrical Shielding Gaskets have been designed to function equally well in applications requiring sliding movement or direct compression.

- Supplied with standard "D" lance ensuring secure holding power when snapped into a prefabricated hole
- "D" lance provides both multi-directional grip and excellent conductivity
- Wide radius profile allows for maximum contact with minimum compression force
- Clip-On feature allows part to be used in high temperature (above 250°F) applications where adhesives will not function
- Available in our UltraSoft® , 98-Series low force version
- Ideally suited for cardcage handles, PC board grounding or any other application requiring clip-on feature and wiping action
- Shielding effectiveness of 100 dB @ 100 MHz
- Available in a wide variety of plating finishes, see page 1-11
- For load/deflection data see pages 2-33



All dimensions shown are in inches (millimeters) unless otherwise specified.

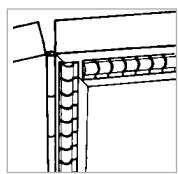
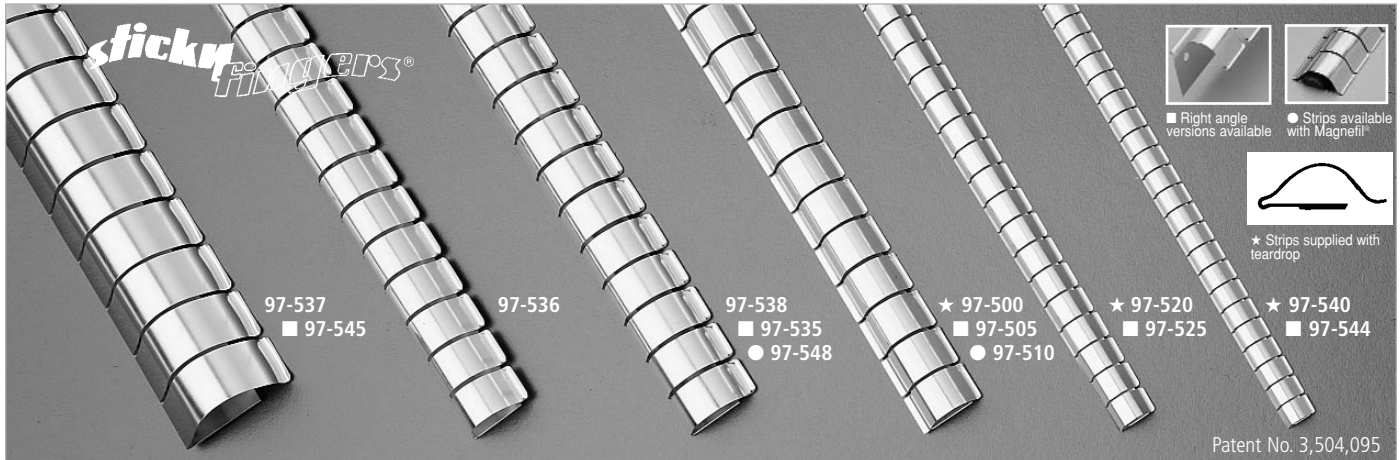

These versatile gaskets are made from high-performance beryllium copper with Sticky Fingers® self-adhesive backing. They provide an extremely tight, instant bond and are ideal as an all-purpose contact strip for metal cabinets and electronic enclosures, particularly where space is critical.

Strips 97-500 and 97-538 are furnished in standard lengths of 24.000 in. (609.600 mm) and in continuous 25.0 ft. (7.6 m) coils. Series 97-520 and 97-540 are supplied in standard 16.000 in. (406.400 mm) lengths and in 25.0 ft. (7.6 m) coils. Strips 97-537, 97-535 and 97-545 are supplied in 12.000 in. (304.800 mm) lengths. All are available in your choice of finishes, see page 1-11. For load/deflection data, see page 2-33.

Magnetic field shielding effectiveness of these strips has been proven to be > 46 dB for a 14 kHz plane wave and 108 dB for a 10 GHz plane wave. When tested per MIL-STD-285 for electromagnetic shielding, these strips showed superior performance under minimum compression. They proved to be especially effective where variations exist in the space to be shielded and in applications that require high shielding performance despite frequent opening and closing of the cabinet.

Please note that designated strips are available with Magnefil®, a rubber strip filled with magnetic absorbing particles and inserted within the curve of the fingers. Magnefil provides increased magnetic field shielding.

These 97-Series products are also available in UltraSoft® low compression force 98-Series.

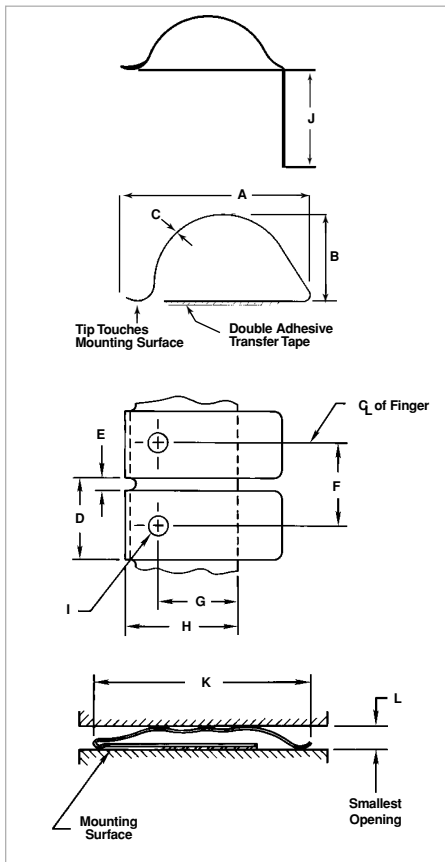

ALL-PURPOSE SERIES

SERIES	A MIN.	B	C	D	E	F	G	H	I	J	K	L	APPROX. LENGTH	APPROX. COIL FT (M)
97-500	0.600 (15.240)	0.230 (5.842)	0.004 (0.102)	0.375 (9.525)	0.032 (0.813)	0.380 (9.652)	0.310 (7.874)	0.500 (12.700)	0.080 (2.032)	N/A	0.770 (19.558)	0.040 (1.016)	24,000 (609.600)	25.0 (7.6)
97-505	0.600 (15.240)	0.230 (5.842)	0.004 (0.102)	0.375 (9.525)	0.032 (0.813)	0.380 (9.652)	0.310 (7.874)	N/A	0.080 (2.032)	0.500 (12.700)	0.770 (19.558)	0.040 (1.016)	24,000 (609.600)	25.0 (7.6)
97-510	0.600 (15.240)	0.230 (5.842)	0.004 (0.102)	0.375 (9.525)	0.032 (0.813)	0.380 (9.652)	0.310 (7.874)	0.500 (12.700)	0.080 (2.032)	N/A	0.770 (19.558)	0.040 (1.016)	24,000 (609.600)	25.0 (7.6)
97-520	0.370 (9.398)	0.140 (3.556)	0.003 (0.076)	0.250 (6.350)	0.022 (0.559)	0.250 (6.350)	0.090 (2.286)	0.310 (7.874)	0.060 (1.524)	N/A	0.500 (12.700)	0.070 (1.778)	16,000 (406.400)	25.0 (7.6)
97-525	0.370 (9.398)	0.140 (3.556)	0.003 (0.076)	0.250 (6.350)	0.022 (0.559)	0.250 (6.350)	0.090 (2.286)	N/A	0.060 (1.524)	0.320 (8.128)	0.500 (12.700)	0.070 (1.778)	16,000 (406.400)	25.0 (7.6)
97-527	0.280 (7.112)	0.055 (1.397)	0.002 (0.051)	0.125 (3.175)	0.025 (0.635)	N/A	N/A	0.183 (4.648)	N/A	N/A	0.300 (7.620)	0.040 (1.016)	16,000 (406.400)	N/A
97-535	0.780 (19.812)	0.250 (6.350)	0.005 (0.127)	0.375 (9.525)	0.040 (1.016)	0.380 (9.652)	0.380 (9.652)	N/A	0.140 (3.556)	0.480 (12.192)	0.940 (23.876)	0.080 (2.032)	12,000 (304.800)	25.0 (7.6)
97-536	0.670 (17.018)	0.310 (7.874)	0.004 (0.102)	0.375 (9.525)	0.040 (1.016)	0.380 (9.652)	0.380 (9.652)	0.530 (13.462)	0.140 (3.556)	N/A	0.940 (23.876)	0.140 (3.556)	24,000 (609.600)	25.0 (7.6)
97-537	1.130 (28.702)	0.410 (10.414)	0.007 (0.178)	0.500 (12.700)	0.040 (1.016)	0.500 (12.700)	0.560 (14.224)	0.780 (19.812)	0.140 (3.556)	N/A	1.940 (49.276)	0.100 (2.540)	12,000 (304.800)	N/A
97-538	0.780 (19.812)	0.250 (6.350)	0.005 (0.127)	0.375 (9.525)	0.040 (1.016)	0.380 (9.652)	0.380 (9.652)	0.530 (13.462)	0.140 (3.556)	N/A	0.940 (23.876)	0.080 (2.032)	24,000 (609.600)	25.0 (7.6)
97-540	0.280 (7.112)	0.110 (2.794)	0.003 (0.076)	0.188 (4.775)	0.018 (0.457)	0.190 (4.826)	0.080 (2.032)	0.230 (5.842)	0.060 (1.524)	N/A	0.370 (9.398)	0.065 (1.651)	16,000 (406.400)	25.0 (7.6)
97-544	0.260 (6.604)	0.110 (2.794)	0.003 (0.076)	0.188 (4.775)	0.018 (0.457)	0.190 (4.826)	0.080 (2.032)	N/A	0.060 (1.524)	0.240 (6.096)	0.370 (9.398)	0.065 (1.651)	16,000 (406.400)	25.0 (7.6)
97-545	1.130 (28.702)	0.410 (10.414)	0.007 (0.178)	0.500 (12.700)	0.040 (1.016)	0.500 (12.700)	0.560 (14.224)	N/A	0.140 (3.556)	0.750 (19.050)	1.940 (49.276)	0.100 (2.540)	12,000 (304.800)	N/A
97-548	0.780 (19.812)	0.250 (6.350)	0.005 (0.127)	0.375 (9.525)	0.040 (1.016)	0.380 (9.652)	0.380 (9.652)	0.530 (13.462)	0.140 (3.556)	N/A	0.940 (23.876)	0.080 (2.032)	24,000 (609.600)	25.0 (7.6)

All dimensions shown are in inches (millimeters) unless otherwise specified.



97-603
 97-604
 97-605
 97-606
 97-607

97-610
 97-614

97-611
 97-613
 97-615
 97-627

97-612

97-616
 97-619
 97-620
 97-624

97-618
 97-621
 97-622
 97-623

97-628
 97-629
 97-630

97-631
 97-632
 97-633
 97-634

97-640

97-645
 97-646

97-650

This series from Laird Technologies is designed for use where high temperature or other design considerations preclude the use of adhesive-mounted gasketing. Yet it provides the same shielding characteristics and effectiveness as on Sticky Fingers® mounted series. Clip-On Gaskets offer shielding effectiveness >100 dB for 100 MHz plane wave. All are available in your choice of finishes, see page 1-11. For load/deflection data, see pages 2-33.

These 97-Series products are also available in UltraSoft® low compression force 98-Series.

SNAP-TITE® WITH "D" LANCE

This configuration has been designed specifically to provide outstanding holding power. "D" lances snap into drilled or punched holes in the mounting surface to create a strong omni-directional grip with excellent conductivity.

GRIP-TITE® WITH "T" LANCE

Ideal for use with softer materials, such as aluminum or plated plastic. "T" lances bite into the mounting surface and preserve electrical conductivity.

MINI CLIP-ON

Laird Technologies' Mini Clip-On (97-645/646) Gaskets are designed for use on today's thinner, lighter materials.

- Lowest compression force available in clip-on configuration
- Virtually no compression set – 100% recovery of original height at up to 60% compression
- "D" lance for extra holding power
- Optimum conductivity and mechanical properties of beryllium copper
- High cycle life – 50,000 cycles without fracture, wear, or compression set



All dimensions shown are in inches (millimeters) unless otherwise specified.

FINGERSTOCK GASKETS AND METAL GROUNDING PRODUCTS CLIP-ON SERIES



CLIP-ON SERIES

VIEW	SERIES	A	B	C	D	E	F	G	H	APPROX. LENGTH	NO LANCE		SQUARE LANCE SQ	GRIP-TITE® "T" LANCE GT	SNAP-TITE® "D" LANCE ST	LANCE LOCATIONS DIMENSIONS		LANCE TO LANCE DIMS.	BODY STYLE	
											NL				I	J	K	SLOT	SOL.	
2	97-603	0.380 (9.652)	0.200 (5.080)	0.100 (2.540)	0.330 (8.382)	0.005 (0.127)	0.250 (6.350)	0.040 (1.016)	0.060 (1.524)	16.000 (406.400)	—	—	—	—	X	0.250 (6.350)	0.099 (2.515)	0.500 (12.700)	X	—
2	97-604	0.330 (8.382)	0.280 (7.112)	0.070 (1.778)	0.380 (9.652)	0.005 (0.127)	0.250 (6.350)	0.040 (1.016)	0.100 (2.540)	16.000 (406.400)	—	—	—	X	—	0.230 (5.842)	0.204 (5.182)	0.500 (12.700)	X	—
2	97-605	0.380 (9.652)	0.200 (5.080)	0.070 (1.778)	0.380 (9.652)	0.005 (0.127)	0.250 (6.350)	0.040 (1.016)	0.060 (1.524)	16.000 (406.400)	—	—	—	X	—	0.230 (5.842)	0.204 (5.182)	0.500 (12.700)	X	—
2	97-606	0.380 (9.652)	0.200 (5.080)	0.070 (1.778)	0.380 (9.652)	0.005 (0.127)	0.250 (6.350)	0.040 (1.016)	0.060 (1.524)	16.000 (406.400)	—	—	—	—	X	0.250 (6.350)	0.161 (4.089)	0.500 (12.700)	X	—
2	97-607	0.330 (8.382)	0.280 (7.112)	0.070 (1.778)	0.380 (9.652)	0.005 (0.127)	0.250 (6.350)	0.040 (1.016)	0.100 (2.540)	16.000 (406.400)	—	—	—	—	X	0.250 (6.350)	0.161 (4.089)	0.500 (12.700)	X	—
1	97-610	0.300 (7.620)	0.100 (2.540)	0.070 (1.778)	0.190 (4.826)	0.005 (0.127)	0.187 (4.750)	0.047 (1.194)	0.065 (1.651)	16.000 (406.400)	X	—	—	#	#	—	—	—	—	X
1	97-611	0.300 (7.620)	0.100 (2.540)	0.070 (1.778)	0.190 (4.826)	0.005 (0.127)	0.182 (4.623)	0.047 (1.194)	0.060 (1.524)	16.000 (406.400)	—	—	—	X	—	0.364 (9.246)	0.062 (1.575)	0.728 (18.491)	X	—
1	97-612	0.440 (11.176)	0.100 (2.540)	0.070 (1.778)	0.190 (4.826)	0.003 (0.076)	0.187 (4.750)	0.047 (1.194)	0.045 (1.143)	16.000 (406.400)	#	X	—	—	—	0.093 (2.362)	0.050 (1.270)	0.750 (19.050)	X	—
1	97-613	0.300 (7.620)	0.100 (2.540)	0.070 (1.778)	0.190 (4.826)	0.005 (0.127)	0.182 (4.623)	0.047 (1.194)	0.060 (1.524)	16.000 (406.400)	—	—	—	—	X	0.364 (9.246)	0.054 (1.372)	0.728 (18.491)	X	—
1	97-614	0.300 (7.620)	0.100 (2.540)	0.050 (1.270)	0.190 (4.826)	0.005 (0.127)	0.187 (4.750)	0.047 (1.194)	0.065 (1.651)	16.000 (406.400)	X	—	—	#	#	—	—	—	—	X
1	97-615	0.297 (7.544)	0.100 (2.540)	0.050 (1.270)	0.187 (4.750)	0.005 (0.127)	0.182 (4.623)	0.047 (1.194)	0.050 (1.270)	16.000 (406.400)	—	—	—	—	X	0.364 (9.246)	0.309 (7.849)	0.728 (18.491)	—	X
1	97-616	0.420 (10.668)	0.120 (3.048)	0.100 (2.540)	0.250 (6.350)	0.005 (0.127)	0.187 (4.750)	0.047 (1.194)	0.095 (2.413)	16.000 (406.400)	X	—	—	—	—	—	—	—	—	X
1	97-618	0.420 (10.668)	0.140 (3.556)	0.060 (1.524)	0.210 (5.334)	0.005 (0.127)	0.187 (4.750)	0.047 (1.194)	0.080 (1.778)	16.000 (406.400)	—	—	—	—	X	0.500 (12.700)	0.065 (1.651)	1.000 (25.400)	—	X
1	97-619	0.440 (11.176)	0.080 (2.032)	0.050 (1.270)	0.190 (4.826)	0.005 (0.127)	0.187 (4.750)	0.047 (1.194)	0.045 (1.143)	16.000 (406.400)	X	—	—	#	#	—	—	—	—	X
1	97-620	0.440 (11.176)	0.080 (2.032)	0.070 (1.778)	0.190 (4.826)	0.005 (0.127)	0.187 (4.750)	0.047 (1.194)	0.045 (1.143)	16.000 (406.400)	X	—	—	#	#	—	—	—	—	X
1	97-621	0.440 (11.176)	0.120 (3.048)	0.070 (1.778)	0.230 (5.842)	0.005 (0.127)	0.193 (4.902)	0.046 (1.168)	0.070 (1.778)	16.000 (406.400)	—	—	—	X	—	0.652 (16.561)	0.084 (2.134)	1.351 (34.315)	X	—
1	97-622	0.440 (11.176)	0.120 (3.048)	0.070 (1.778)	0.190 (4.826)	0.005 (0.127)	0.193 (4.902)	0.046 (1.168)	0.075 (1.905)	16.000 (406.400)	—	—	—	—	X	0.290 (7.366)	0.060 (1.524)	0.725 (18.415)	X	—
1	97-623	0.420 (10.668)	0.080 (2.032)	0.070 (1.778)	0.187 (4.750)	0.005 (0.127)	0.187 (4.750)	0.047 (1.194)	0.045 (1.143)	16.000 (406.400)	—	—	—	—	X	0.530 (13.462)	0.064 (1.626)	1.000 (25.400)	—	X
1	97-624	0.420 (10.668)	0.140 (3.556)	0.060 (1.524)	0.210 (5.334)	0.005 (0.127)	0.187 (4.750)	0.047 (1.194)	0.080 (2.032)	16.000 (406.400)	X	—	—	—	—	—	—	—	—	X
1	97-627	0.297 (7.544)	0.099 (2.515)	0.070 (1.778)	0.187 (4.750)	0.005 (0.127)	0.187 (4.750)	0.047 (1.194)	0.049 (1.245)	16.000 (406.400)	—	—	—	—	X	0.280 (7.112)	0.049 (1.245)	0.748 (19.000)	—	X
1	97-628	0.600 (15.240)	0.210 (5.334)	0.100 (2.540)	0.230 (5.842)	0.005 (0.127)	0.187 (4.750)	0.047 (1.194)	0.070 (1.778)	16.000 (406.400)	X	—	—	#	#	—	—	—	—	X
1	97-629	0.600 (15.240)	0.210 (5.334)	0.050 (1.270)	0.190 (4.826)	0.005 (0.127)	0.187 (4.750)	0.047 (1.194)	0.070 (1.778)	16.000 (406.400)	X	—	—	#	#	—	—	—	—	X
1	97-630	0.600 (15.240)	0.210 (5.334)	0.070 (1.778)	0.190 (4.826)	0.005 (0.127)	0.187 (4.750)	0.047 (1.194)	0.070 (1.778)	16.000 (406.400)	X	—	—	#	#	—	—	—	—	X
1	97-631	0.600 (15.240)	0.210 (5.334)	0.070 (1.778)	0.190 (4.826)	0.005 (0.127)	0.182 (4.623)	0.047 (1.194)	0.080 (2.032)	16.000 (406.400)	—	—	—	X	—	0.364 (9.246)	0.058 (1.473)	0.728 (18.491)	X	—
1	97-632	0.600 (15.240)	0.210 (5.334)	0.070 (1.778)	0.190 (4.826)	0.005 (0.127)	0.182 (4.623)	0.047 (1.194)	0.080 (2.032)	16.000 (406.400)	—	—	—	—	X	0.364 (9.246)	0.058 (1.473)	0.728 (18.491)	X	—
1	97-633	0.600 (15.240)	0.210 (5.334)	0.050 (1.270)	0.190 (4.826)	0.005 (0.127)	0.182 (4.623)	0.047 (1.194)	0.080 (2.032)	16.000 (406.400)	—	—	—	X	—	0.364 (9.246)	0.058 (1.473)	0.728 (18.491)	X	—
1	97-634	0.600 (15.240)	0.210 (5.334)	0.050 (1.270)	0.190 (4.826)	0.005 (0.127)	0.182 (4.623)	0.047 (1.194)	0.080 (2.032)	16.000 (406.400)	—	—	—	—	X	0.364 (9.246)	0.058 (1.473)	0.728 (18.491)	X	—
1	97-640	1.090 (27.686)	0.260 (6.604)	0.070 (1.778)	0.280 (7.112)	0.005 (0.127)	0.375 (9.525)	0.040 (1.016)	0.060 (1.524)	16.000 (406.400)	X	—	—	#	#	—	—	—	—	X
3	97-645	0.210 (5.334)	0.070 (1.778)	0.045 (1.143)	0.250 (6.350)	0.003 (0.076)	0.200 (5.080)	0.030 (0.762)	0.010 (0.254)	24.000 (609.600)	—	—	—	—	X	0.485 (12.319)	0.133 (3.378)	1.000 (25.400)	X	—
3	97-646	0.275 (6.985)	0.080 (2.036)	0.040 (1.016)	0.280 (7.112)	0.006 (0.152)	0.250 (6.350)	0.030 (0.762)	0.030 (0.762)	24.000 (609.600)	—	—	—	—	X	0.500 (12.700)	0.143 (3.627)	1.000 (25.400)	—	X
1	97-650	0.980 (24.892)	0.400 (10.160)	0.200 (5.080)	0.300 (7.620)	0.004 (0.102)	1.000 (25.400)	0.030 (0.762)	0.200 (5.080)	16.000 (406.400)	#	#	—	—	—	0.192 (4.877)	0.120 (3.048)	0.486 (12.344)	X	—

All dimensions shown are in inches (millimeters) unless otherwise specified.

X Standard

Optional



Laird Technologies offers its line of low profile beryllium copper shielding fingerstock. Simple installation is accomplished by hooking one end of the gasket onto the edge of the housing. The other end is secured with pressure sensitive adhesive (PSA) with extra-wide release liner and designed with a teardrop feature to improve surface contact. Ideally suited for low profile, bi-directional applications such as the rack mounting of linecards in telecommunications equipment. The gaskets offer high shielding performance in applications where space may be limited.

FIGURE 1

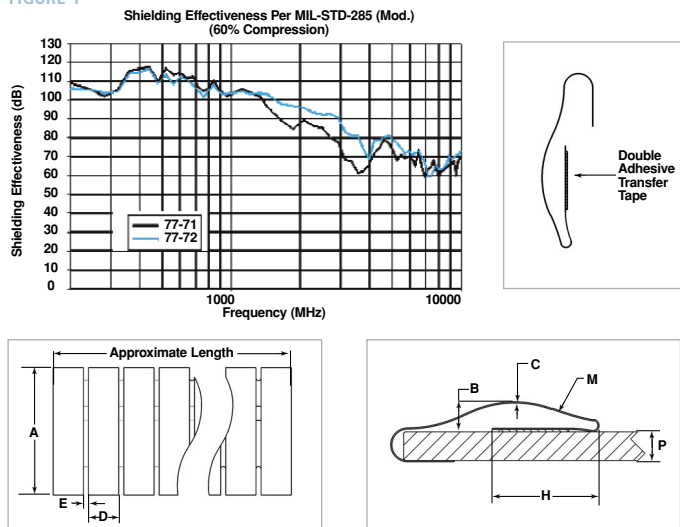

- Dual attachment provides a no snag gasket with secure retention, which allows bi-directional wiping action
- Incorporates extra wide release liner to facilitate easy installation
- Wide variety of plating finishes are available to meet your galvanic compatibility requirements
- Offered in standard lengths of 16.200 in. (411.480 mm) or cut to your desired length
- Available in UltraSoft® (-78) low force version

DIMENSIONS

SERIES	A	B	C	D	E	H	M	P	APPROX. LENGTH	NO. OF FINGERS
77-071	0.450 (11.430)	0.060 (1.524)	0.004 (0.102)	0.125 (3.175)	0.018 (0.457)	0.267 (6.782)	0.200 (5.080)	0.062 (1.575)	16.200 (411.480)	130
77-072	0.600 (15.240)	0.090 (2.286)	0.004 (0.102)	0.125 (3.175)	0.018 (0.457)	0.329 (8.357)	0.200 (5.080)	0.062 (1.575)	16.200 (411.480)	130



- Extra wide release liner of pressure sensitive tape provides for easy, cost-effective installation
- Low compression force
- Available in a wide variety of plated finishes to meet your galvanic compatibility needs
- Available in UltraSoft (-78) low force version
- Offered in standard lengths of 16.000 in. (406.400 mm), or cut to your desired length

Laird Technologies offers its line of low profile beryllium copper shielding fingerstock. The gaskets are provided with pressure sensitive adhesive tape with an extra wide release liner to facilitate secure placement and ease of application.

- Ideally suited for limited space applications as low as 0.060 in. (1.524 mm)
- Works well in both compression and bi-directional applications
- High shielding effectiveness; average 90dB from 10 kHz to 1GHz

LOW PROFILE SERIES

SERIES	A	B	C	D
77-043	0.450 (11.430)	0.080 (2.032)	0.121 (3.073)	0.262 (6.665)
77-049	0.600 (15.240)	0.120 (3.048)	0.162 (4.115)	0.347 (8.814)



All dimensions shown are in inches (millimeters) unless otherwise specified.



These standard beryllium copper contact gaskets offer ideal RFI/EMI shielding of doors and movable components in electronic shielded rooms, trailers, computers and communication equipment.

They have been scientifically designed for wiping closures, but are also usable in compression applications. Moreover, these contact strips feature extremely good endurance life, as well as a high deflection range. In tests, attenuation up to 112 dB has been measured for a 100 MHz plane wave. Fastening of the strip is usually accomplished using screws or rivets. Soldering is optional.

Both are available in continuous lengths to a maximum of 25.0 ft. (7.6 m) and in all standard finishes, see page 1-11. For load/deflection data, see page 2-33.

These 97-Series products are also available in UltraSoft® low compression force 98-Series.



LARGE ENCLOSURE SERIES

SERIES	A REF.	B MIN.	C	D	E	F	G	H DIA.	I	L	APPROX. LENGTH FT. (M)
97-438	1.090 (27.686)	0.250 (6.350)	0.005 (0.127)	0.375 (9.525)	0.040 (1.016)	0.160 (4.064)	0.380 (9.652)	0.140 (3.556)	1.270 (32.258)	0.080 (2.032)	25.000 (7.6)
97-440	1.630 (41.402)	0.410 (10.414)	0.007 (0.178)	0.500 (12.700)	0.040 (1.016)	0.190 (4.826)	0.500 (12.700)	0.140 (3.556)	1.900 (48.260)	0.100 (2.540)	25.000 (7.6)



Mechanically balanced strips with high deflection range and long endurance life-provide a perfect fit as spring clips hold the gaskets firmly in place. It means more simplified design and construction of cabinets and enclosures. Attenuation > 102 dB for a 100 MHz plane wave has been measured using Series 97-436 gaskets. For standard finishes, see page 1-11. For load/deflection data, see page 2-33. These 97-Series products are also available in UltraSoft low compression force 98-Series.

QUICK SPRING CLIP FASTENERS (97-445)

Designed for use with Series 97-436 finger gaskets, spring clip fasteners permit full strip compression. Easy to install, they permit lifting of gasket for cleaning of contact surface. Packaged in lots of 1,000. Available in standard finishes, see page 1-11.



All dimensions shown are in inches (millimeters) unless otherwise specified.

▲ Quick Spring Clip Fastener provides full strip compression; allows lifting of product for cleaning of contact surface.



This version of Sticky Fingers® beryllium copper shielding gaskets features a special U-shaped end that permits the finger of the strip to slide when enclosure doors are closed. It also retains the strip's fingers when enclosure doors are open, thus preventing accidental damage to the fingers. Shielding effectiveness is >115 dB for a 100 MHz plane wave.

Four models provide you a choice of widths to suit your application. They are available in standard 16.000 in. (406.400 mm) lengths, except 97-515 which is furnished in 24.000 in. (609.600 mm) lengths. Also, all styles are available in continuous 25.0 ft. (7.6 m) coils, and in your choice of all finishes except tin lead and satin tin, see page 1-11. For load/deflection data, see page 2-33.

These 97-Series products are also available in UltraSoft® low compression force 98-Series.

Patent No. 3,504,095



FOLDOVER SERIES

SERIES	A	B	C	D PITCH	E SLOT	I DIA.	L	APPROX. LENGTH IN. (MM)	APPROX. COIL FT. (M)
97-515	0.760 (19.304)	0.230 (5.842)	0.004 (0.102)	0.375 (9.525)	0.032 (0.813)	0.080 (2.032)	0.060 (1.524)	24.000 (609.600)	25.0 (7.6)
97-521	0.510 (12.954)	0.140 (3.556)	0.003 (0.076)	0.250 (6.350)	0.022 (0.559)	0.060 (1.524)	0.070 (1.778)	16.000 (406.400)	25.0 (7.6)
97-541	0.380 (9.652)	0.120 (3.048)	0.003 (0.076)	0.188 (4.775)	0.018 (0.457)	0.060 (1.524)	0.050 (1.270)	16.000 (406.400)	25.0 (7.6)
97-542	0.250 (6.350)	0.080 (2.032)	0.003 (0.076)	0.188 (4.775)	0.018 (0.457)	0.060 (1.524)	0.050 (1.270)	16.000 (406.400)	25.0 (7.6)



Series 97-941/921 are low compression, flexible beryllium copper contact strips for applications where a continuous shield must conform to irregular shapes and turn tight radius corners in either direction.

Simple snap-in installation is possible for Series 97-921 with 0.250 in. (6.350 mm) slots and 97-941 with 0.190 in. (4.826 mm) slots. However, soft solder or conductive adhesive can be used for mounting to flat surfaces.

Shielding effectiveness is >115 dB for a 100 MHz plane wave.

Available in standard 24.000 in. (609.600 mm) lengths in all standard finishes, see page 1-11. For load/deflection data, see page 2-33.

FLEXIBLE LOW COMPRESSION SERIES

SERIES	A	B	C	L	Q	R	APPROX. LENGTH
97-921	0.260 (6.604)	0.230 (5.842)	0.003 (0.076)	0.140 (3.556)	0.120 (3.048)	0.250 (6.350)	24.0 (609.600)
97-941	0.200 (5.080)	0.170 (4.318)	0.003 (0.076)	0.110 (2.794)	0.090 (2.286)	0.190 (4.826)	24.0 (609.600)

All dimensions shown are in inches (millimeters) unless otherwise specified.



Adhesive-mounted beryllium copper contact strips with scientific twist design offer narrow electronic gaskets for general shielding applications.

Different widths are available to suit your specific application for single edge contact strips. Also available are two 90 degree versions (Series 97-551 and 97-558)

to provide alternate mounting capability. Series 97-555, 97-558 and 97-559 provide shielding effectiveness > 100 dB for a 100 MHz plane wave, ideal for all types of panel or electronic enclosures. Series 97-550, 97-551 and 97-560 provide shielding effectiveness > 115 dB for a 100 MHz plane wave. Series 97-560 strips are especially suitable for cabinets with panel divider bars. Their unique double-edge design permits panels to be removed easily and replaced without damage to the installed strip.

All Twist Series strips are furnished in 24.000 in. (609.600 mm) lengths. Strips (except 97-551 and 97-558) are also available in standard 25.0 ft. (7.6 m) coils. Right angle product configurations are not available in coils. All are available in your choice of finishes, see page 1-11. For load/deflection data, see page 2-33.

COMBINATION ENVIRONMENTAL RUBBER GASKET

Series 97-556 and 97-561 are versions of 97-555 and 97-560, respectively, incorporating a Poron® rubber gasket to act as an environmental shield, offering a high degree of protection against dust and moisture. All are available in your choice of finishes, see page 1-11. For load/deflection data, see page 2-33.

These 97-Series products are also available in UltraSoft® low compression force 98-Series.



TWIST SERIES

SERIES	A	B	C	D PITCH	E SLOT	H	APPROX. LENGTH IN. (MM)	APPROX. COIL FT. (M)	GASKET
97-550	0.230 (5.842)	0.030 (0.762)	0.003 (0.076)	0.095 (2.413)	0.015 (0.381)	0.140 (3.556)	24.000 (609.600)	25.0 (7.6)	NO
97-551	0.160 (4.064)	0.030 (0.762)	0.003 (0.076)	0.095 (2.413)	0.015 (0.381)	0.080 (2.032)	24.000 (609.600)	—	NO
97-555	0.340 (8.636)	0.070 (1.778)	0.003 (0.076)	0.165 (4.191)	0.015 (0.381)	0.180 (4.572)	24.000 (609.600)	25.0 (7.6)	NO
97-556	0.340 (8.636)	0.070 (1.778)	0.003 (0.076)	0.165 (4.191)	0.015 (0.381)	0.180 (4.572)	24.000 (609.600)	25.0 (7.6)	YES
97-558	0.200 (5.080)	0.070 (1.778)	0.003 (0.076)	0.165 (4.191)	0.015 (0.381)	0.110 (2.794)	24.000 (609.600)	—	NO
97-559	0.300 (7.620)	0.070 (1.778)	0.003 (0.076)	0.165 (4.191)	0.015 (0.381)	0.180 (4.572)	24.000 (609.600)	25.0 (7.6)	NO
97-560	0.500 (12.700)	0.070 (1.778)	0.003 (0.076)	0.165 (4.191)	0.015 (0.381)	0.190 (4.826)	24.000 (609.600)	25.0 (7.6)	NO
97-561	0.500 (12.700)	0.070 (1.778)	0.003 (0.076)	0.165 (4.191)	0.015 (0.381)	0.190 (4.826)	24.000 (609.600)	25.0 (7.6)	YES
97-567	0.725 (18.415)	0.209 (5.309)	0.003 (0.076)	0.500 (12.700)	0.015 (0.381)	0.408 (10.363)	24.000 (609.600)	25.0 (7.6)	NO
97-569	0.500 (12.700)	0.120 (3.048)	0.003 (0.076)	0.250 (6.350)	0.015 (0.381)	0.250 (6.350)	24.000 (609.600)	25.0 (7.6)	NO



All dimensions shown are in inches (millimeters) unless otherwise specified.



Ideal for general shielding applications where mounting space is at a premium, Clip-On Twist Series strips combine the performance advantages of scientific twist design with the strength of clip-on mounting.

Clip-On Twist Series gaskets are offered in four different widths, each available in either equal leg or offset leg configurations. In addition, each offset leg configuration is available with Poron® rubber environmental gaskets for dust and moisture resistance, as well as with "D" lances that snap into 0.100 in. (2.540 mm) diameter holes to provide added mounted strength.

This series offers shielding effectiveness > 115 dB for a 100 MHz plane wave and is provided in standard 16.000 in. (406.400 mm) lengths. All are available in your choice of finishes, see page 1-11. For load/deflection data, see page 2-33.

These 97-Series products are also available in UltraSoft® low compression force 98-Series.



CLIP-ON TWIST SERIES

SERIES	A	B	C	D	E	PITCH	SLOT	APPROX. LENGTH	PART NO.		
									WITH "D" LANCE	WITH PORON®	WITH "D" LANCE WITH PORON®
97-552	0.150 (3.810)	0.030 (0.762)	0.070 (1.778)	0.150 (3.810)	0.003 (0.076)	0.095 (2.413)	0.015 (0.381)	16.000 (406.400)	97-553	—	—
97-563	0.210 (5.334)	0.070 (1.778)	0.070 (1.778)	0.210 (5.334)	0.003 (0.076)	0.165 (4.191)	0.015 (0.381)	16.000 (406.400)	97-564	—	—
97-568*	0.414 (10.516)	0.210 (5.334)	0.070 (1.778)	0.414 (10.516)	0.003 (0.076)	0.500 (12.700)	0.015 (0.381)	16.000 (406.400)	—	—	—
97-572	0.275 (6.985)	0.030 (0.762)	0.070 (1.778)	0.175 (4.445)	0.003 (0.076)	0.095 (2.413)	0.015 (0.381)	16.000 (406.400)	97-574	97-573	97-575
97-576	0.378 (9.601)	0.075 (1.905)	0.070 (1.778)	0.250 (6.350)	0.003 (0.076)	0.165 (4.191)	0.015 (0.381)	16.000 (406.400)	97-578	97-577	97-579
97-580	0.275 (6.985)	0.030 (0.762)	0.050 (1.270)	0.175 (4.445)	0.003 (0.076)	0.095 (2.413)	0.015 (0.381)	16.000 (406.400)	97-582	97-581	97-583
97-584	0.378 (9.601)	0.075 (1.905)	0.050 (1.270)	0.250 (6.350)	0.003 (0.076)	0.165 (4.191)	0.015 (0.381)	16.000 (406.400)	97-586	97-585	97-587
97-589	0.230 (5.842)	0.031 (0.787)	0.070 (1.778)	0.160 (4.064)	0.003 (0.076)	0.095 (2.413)	0.015 (0.381)	24.000 (609.000)	—	—	—
97-590	0.160 (4.064)	0.030 (0.762)	0.040 (1.016)	0.160 (4.064)	0.003 (0.076)	0.095 (2.413)	0.015 (0.381)	16.000 (406.400)	97-593	—	—

*Standard with "D" Lance

All dimensions shown are in inches (millimeters) unless otherwise specified.



Laird Technologies offers the Divider Edge Shield, the latest addition to its line of longitudinal shielding and grounding products. The Divider Edge Shield is designed to accommodate the industry's trend toward miniaturization and reduced compression forces.

- Designed to be applied to the top edge of multi-compartmental castings with wall thickness from 0.035 in. (0.889 mm) to 0.055 in. (1.397 mm)
- Clip-on design allows for easy installation and secure retention
- Unique finger design provides extremely low compression force
- Excellent shielding and grounding properties
- Provided in standard 12.000 in. (304.800 mm) lengths, or easily cut to your desired length. Longer lengths available upon request.
- 97-654 is available with "D" Lance option

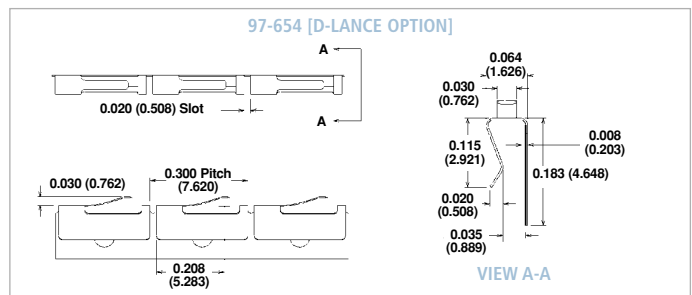
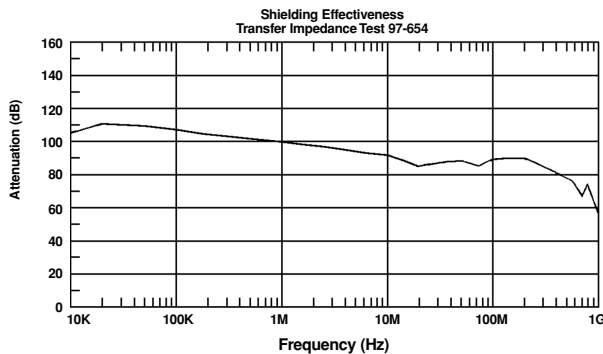

Laird Technologies introduces the Card Guide Clip-On, which offers excellent grounding contact from the PC board to a card guide on a rack. The unique snap-in feature of the contact finger prevents any potential snagging. This allows for bi-directional sliding contact. The Card Guide Clip-On gasket installs to the edge of the board and makes contact with ground trace on the card. The card then slides into the card guide on the rack. Low compression forces allow for easy installation of the card.

- Easily installs onto PC board
- Provides for bi-directional wiping that eliminates snagging
- Ideal, inexpensive solution for grounding applications
- High-performance beryllium copper can be plated with a wide variety of finishes for galvanic compatibility, see page 1-11
- Designed for board thicknesses of 0.085 in. to 0.100 in. (2.159 mm to 2.540 mm)
- Design capabilities available to handle other board thicknesses and custom applications
- 97-983 is available with "D" Lance option

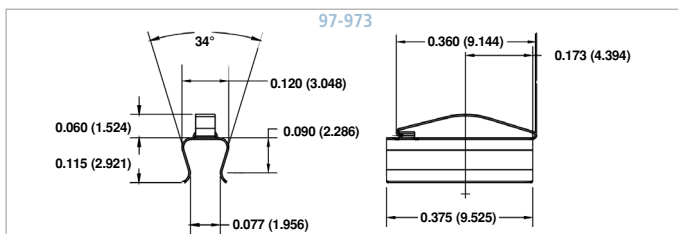
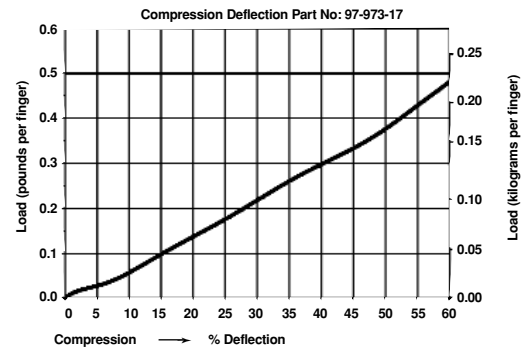
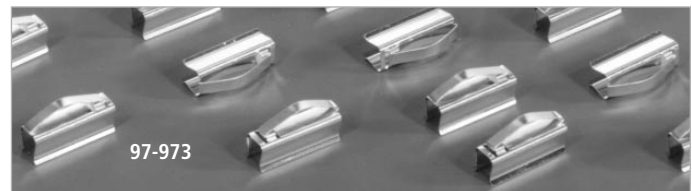

All dimensions shown are in inches (millimeters) unless otherwise specified.

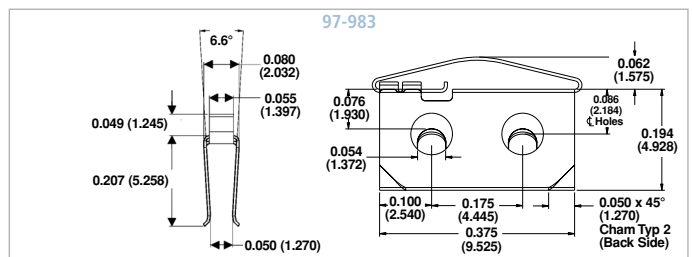



97-656

This product offers a clip-on design that permits shielding to a perpendicular surface.

- Finger design allows for continuous contact across the length of the strip
- Clip-on design is ideal where high temperature or other design considerations preclude the use of adhesive-mounted gasketing
- "D" lance design provides excellent retention of gasket and allows for a strong omni directional grip
- Supplied in a wide variety of plating finishes, see page 1-11
- Shielding effectiveness of > 80 dB for a 10 MHz plane wave. For load/deflection data, see page 2-33.

These 97-Series products are also available in UltraSoft® low compression force 98-Series.



97-655

Laird Technologies offers the first clip-on design which allows grounding to occur between perpendicular surfaces.

- Unique finger extension provides grounding from card or motherboard to a backplane housing
- Finger height provides wide operating range
- Wide clip-on area with "D" lance gives additional reliable retention
- Available in strip lengths up to 12.000 in. (304.800 mm)
- Available in a wide variety of plating finishes, see page 1-11. For load/deflection data, see page 2-33.

These 97-Series products are also available in UltraSoft®, 98-Series.



All dimensions shown are in inches (millimeters) unless otherwise specified.



The Clip-On Longitudinal Grounding Strip combines finger compression with the direction of motion in the longitudinal axis.

- Ideal for use with rack-mounted, sliding door and slide drawer assemblies
- Clip-on mounting combines ease of installation with impressive retention strength
- FEA (Finite Element Analysis) design of fingers eliminates the need for left or right installations
- Asymmetrical finger design with shallow angle provides for bi-directional engagement
- Available in a wide variety of plating finishes, see page 1-11
- Supplied in standard lengths of 17.000 in. (431.800 mm)
- For load/deflection data, see page 2-33

Available in UltraSoft® low compression version (98-976).



The Mini-Longitudinal Grounding Gasket is designed to accommodate small applications which often require lower compression forces.

- Allows a longitudinal sliding motion over the length of the gasket
- Ideal for rack-mounted, sliding door or side panel and drawer assemblies
- Mounting methods include conductive tapes, rivets or screws
- Miniaturized design includes extremely narrow width and low standing height
- Available in a wide variety of plated finishes, see page 1-11
- For load/deflection data, see page 2-33

Available in UltraSoft low compression version (98-974).



All dimensions shown are in inches (millimeters) unless otherwise specified.



This series of beryllium copper strips combines finger compression with the direction of motion in the longitudinal axis.

- Ideal for use with rack-mounted and slide drawer assemblies
- Provides reliable and complete grounds
- Typical installation methods include hardware mounting or use of the Sticky Fingers® self-adhesive strip
- In standard finishes, see page 1-11
- For load/deflection data, see page 2-33

Available in UltraSoft® low compression version (98-975).



UltraSoft® fingers have been designed for communications, computers and electronic systems designers concerned with EMI compliance and lightweight enclosure designs. Available in the same full range of standard configurations, UltraSoft fingers offer designers greater flexibility and versatility than ever before—permitting more extensive use of lighter, thinner construction materials to help cut costs and/or enhance system performance.

The unique advantages of UltraSoft (98-Series) fingers include:

- The lowest compression forces in the industry
- Increased life cycle
- Shielding effectiveness comparable to similarly configured standard 97-Series parts
- Wide selection of sizes and configurations
- Low compression force version available for virtually every standard shielding product

UltraSoft (98-Series) products are available in the same lengths as the standard (97-Series) products. Please refer to the appropriate standard product pages for specific information. All UltraSoft products are also available in your choice of finishes, see page 1-11. For load/deflection data, see page 2-33.

SHIELDING EFFECTIVENESS COMPARISON



All dimensions shown are in inches (millimeters) unless otherwise specified.

COMPRESSION FORCE COMPARISON





97-487/488 COIN BATTERY APPLICATIONS

These contacts are surface mount soldered to a PC board. Separately mounted contacts can be positioned to accommodate a wide range of battery sizes. The coin battery is captivated by the device housing and held in contact. These contacts are provided with gold plating as standard.

Typical applications for the 97-487/488 contacts are low powered portable devices, such as pocket organizers, portable medical devices and any device that uses coin batteries.

97-489 BATTERY PACK CONTACTS

These contacts are soldered onto a PC board and protrude through cutouts in a plastic housing. Contact is made as the prismatic battery pack mates with the housing and pushes the contacts back into the cutouts.

The contacts are provided with nickel plating as standard. Gold plating is available.

Typical applications for the 97-489 contacts are portable devices with removable battery packs, such as video cameras, radios, power tools, etc.

97-490 AA/AAA BATTERY CONTACT APPLICATIONS

These contacts mount onto a PC board and protrude into a cutout at the end of a battery well. Backup ribs must be provided in the plastic molding. The contacts are provided with nickel plating as standard. Gold plating is optionally available.

Built-in stop protects over-compression damage. Applications would include any device using AA or AAA batteries, particularly devices with high mechanical and electrical performance such as medical, GPS and surveying instruments.

Laird Technologies announces the addition of a battery contact product line. These high-performance battery contacts are suitable for coin battery applications, battery pack contact applications and AA/AAA battery applications.

Supplied in heat treated beryllium copper, the contacts offer superb contact force and a large compression range. Heat treatment of beryllium copper significantly reduces the material's internal stress, thereby allowing a wide range of compression to accommodate variations in battery size and placement.

- All contacts are surface mounted and require solder pads, except for 97-490 which is thru-pin mounted and requires mount holes
- Available in tape and reel packaging for high volume pick-and-place assembly
- Available in a variety of plated finishes for galvanic compatibility
- Custom designs can be developed by calling our application engineers

97-487/97-488 COIN BATTERY APPLICATIONS

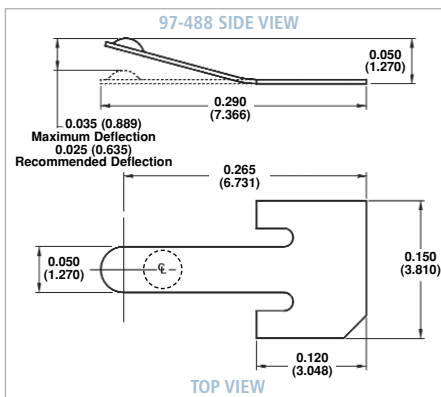

All dimensions shown are in inches (millimeters) unless otherwise specified.



97-489 BATTERY PACK CONTACTS



97-490 AA/AAA BATTERY CONTACT APPLICATIONS

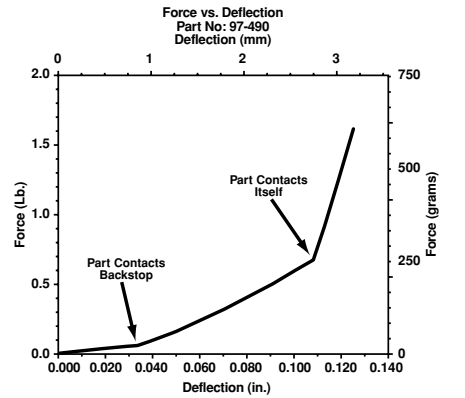
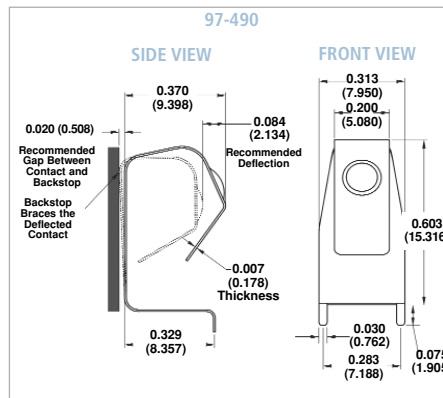
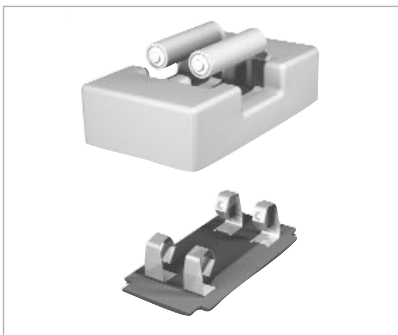

All dimensions shown are in inches (millimeters) unless otherwise specified.



Laird Technologies' extensive product line solves hundreds of EMC problems. But each customer problem is unique. One of our standard products may not precisely meet your needs. Often a modest modification in one of our existing products will solve your problem quickly, effectively and economically.

Consider these modification possibilities:

- Special finishes
- Substitution of an alloy with differing properties
- Special lengths or coils
- Adjustment in base thicknesses
- Addition of bends, slots, holes
- Changes in width of mounting surfaces
- Removal of fingers

Let one of our application engineers show you a full range of modified standard possibilities.



Laird Technologies' experts combine half a century of EMC experience with state-of-the-art CAD capabilities to help you determine the optimum design for your application. Chances are we have solutions to problems you may not yet have encountered.

PROTOTYPING

Maximum flexibility and minimum tooling make our prototyping fast and economical. There is an entire fabricating operation dedicated to short runs. Our in-house design, plating and heat-treating also keep your costs down.

PRODUCTION

From CAD/CAM technologies through EMC testing, Laird Technologies offers the complete in-house capabilities expected from the leading worldwide shielding supplier. Whether your next custom shielding requirement calls for five parts or 5 million, Laird Technologies will be on time and on budget.





Our CAD helps you fine-tune your initial designs. Our finite element analysis (FEA) simulates the performance of that design under actual working conditions. Our CNC equipment helps produce precisely fabricated samples. Our optical gauging inspection system ensures that the latest measurement technology is used to measure your parts. Computer-programmable high-speed Bruderer punch presses enable our progressive dies to produce families of parts economically by eliminating the need for costly multiple dies. The result: Laird Technologies can meet your custom stamping needs with the shortest, most reliable lead times in the industry.

SHORT RUNS A SPECIALTY

With Laird Technologies you get complete prototype and low volume expertise. Our capabilities range from photo-etching and secondary stamping to an extensive selection of universal tooling and short-run production systems.

LAIRD TECHNOLOGIES DOES IT ALL

We provide full in-house tool and die design and manufacturing capabilities including CAD, CAM and the high-precision tolerances of wire EDM. We manufacture custom components for many products, including connectors, switches, and electronic and electromechanical assemblies. Platings – from gold to zinc – are also a part of our capabilities. No wonder some of the world's leading electronics, aerospace, automotive and instrumentation companies turn to Laird Technologies for custom-engineered stampings.

For more information on custom products, contact Laird Technologies' sales department.



Some of the nation's leading manufacturers of high technology products turn to Laird Technologies for their custom assembly requirements. Critical lead time and inspection criteria are ensured by SPC quality control during both stamping and assembly operations.

CAPABILITIES:

- Fully automated or semiautomated equipment
- Heat staking
- Ultrasonic welding
- Resistance welding
- Conventional and orbital riveting
- MIL certification soldering
- Critical/intricate requirements performed
- Special packaging for pick-and-place





MultiSlide fabrication provides high volume production quantities with low-cost tooling. A variety of part configurations can be designed for this economic process. In-house tooling design and manufacturing help reduce lead times.

ADVANTAGES:

- Reduced material consumption
- Variations in materials are available from wire to flat strips
- Fully automated production
- Tooling can be easily reworked to accommodate moderate changes
- Form stations are independently adjustable for part consistency
- Interchangeability of tools
- Economic fabrication of RF board level shields

For more information on custom products, contact Laird Technologies' sales department.

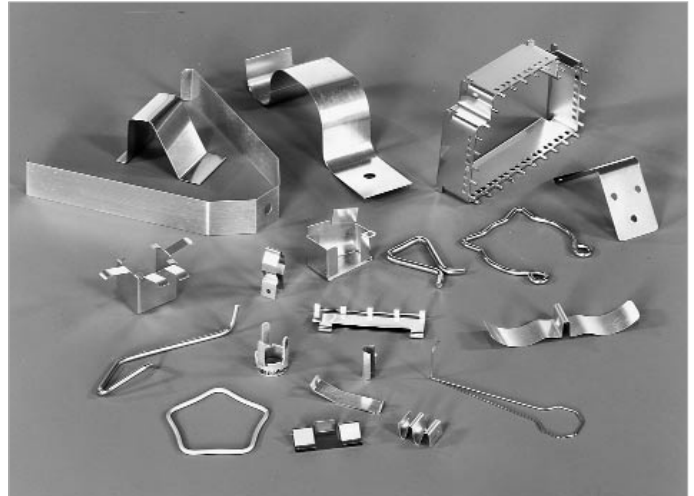

Laird Technologies' broad line of products for cardcage applications assures compliance with shielding, ESD, grounding and packaging requirements.

ADVANTAGES:

- Superior shielding effectiveness
- Low force insertion and removal
- Easy snag-free card installation
- Accommodates wide variations in hardware construction
- Center ribs on select styles serve as guides to prevent card damage
- Available in extruded, die-cut, form-in-place and printed conductive elastomers; beryllium copper, stainless steel and other metals; and conductive fabric over die-cut foam shapes
- Quick turnaround on prototypes and short production runs





Laird Technologies™ has added Drawn Cans to its extensive list of board level shielding solutions. As microprocessor speeds continue to increase, so does the potential for EMI leakage through the smallest apertures in board level shields (BLS). Laird Technologies' Drawn Cans are designed to provide additional near field and far field circuit isolation (attenuation) at higher frequencies by eliminating the apertures found in the corners of traditional BLS solutions. Drawn cans utilize small ground trace sizes, thereby preserving packaging space on the PC board.

- Solid corner designs when additional circuit isolation (attenuation) is required at higher frequencies
- Available in heights up to 0.250" (6.350 mm) with length and width dimensions from 0.300" (7.620 mm) to 2.000" (50.800 mm)
- Unlimited configurations of ventilation holes can be incorporated into the design
- Tape and reel packaging provides an economical and automated SMT attachment method
- Available in cold-rolled steel (CRS), brass, stainless steel, and nickel silver
- Multi-compartmental shielding of components can be achieved with formed partitions
- Mold-In-Place and Form-In-Place Elastomers can be combined with drawn cans to achieve shielding of multiple components with a single part
- Available with an EZ Peel scored lid feature; allows for easy top section removal for component repair and re-sealing

Laird Technologies can custom design a shield specifically to meet your requirements or we can utilize your approved design.

Notice: The data set forth in all text, tables, charts, graphs, and figures herein are based on samples tested and are not guaranteed for all samples or applications. Such data are intended as guides and do not reflect product specification for any specific part.

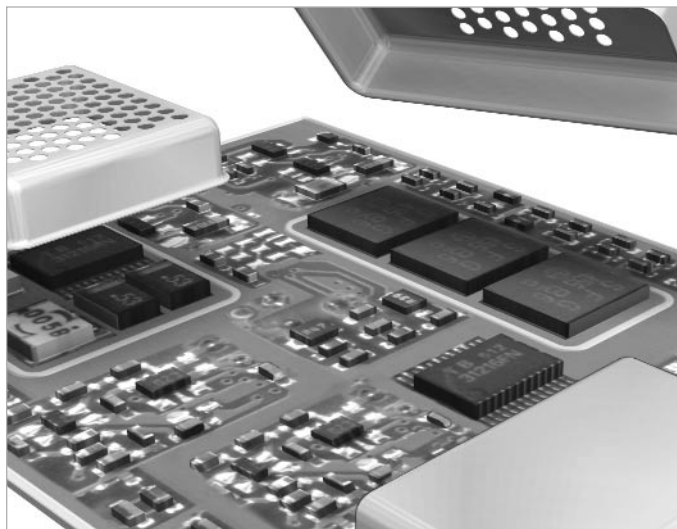

PRINTED CIRCUIT BOARD RADIATED TEST PER PDA-PRO-027 REV. A FOR DRAWN CAN SHIELD W/SOLDER VENTS VS. STANDARD CAN SHIELD



The receive antenna test region from 1 GHz to 10 GHz that defines the Far-Field and Near-Field is 2.0 inches and 0.190 inches, respectively, from the transmit antenna. This test is performed for worst case orientation.

Circuit Isolation is a measurement that defines the resultant attenuation level in dB provided by a PCB shield from an initial reference level as defined in Laird test procedure PDA-PRO-027.

All dimensions shown are in inches (millimeters) unless otherwise specified.



Contact strips are used for grounding and shielding in high-frequency equipment and for forming large diameter contact rings.

A wide variety of beryllium copper contact strips provides engineers and designers with flexibility in solving grounding and shielding problems. Various lengths, widths, thicknesses, contours and hole locations are possible for many of the standard catalog items shown here.

For standard finishes, see page 1-11. For load/deflection data, see page 2-33.

These 97-Series products are also available in UltraSoft® low compression force 98-Series.

Contips®, localized deposits of silver or gold used to enhance conductivity, are available for our contact strips and contact rings. Contips minimum thicknesses are: 0.003 in. (0.076 mm) for silver and 0.0003 in. (0.008 mm) for gold. Please refer to the chart at right for Contips descriptions and suffix catalog numbers.

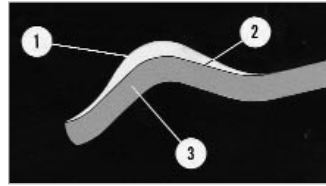

1. Contips
2. 100% bond
3. Convex portion of spring

CONTIPS DESCRIPTION	ADD SUFFIX TO CATALOG NUMBER
Silver Contips only	11
Silver Contips plus silver plating	12
Gold Contips only	13
Gold Contips plus gold plating	14
Gold Contips plus silver plating	20

FIGURE A



▲ Contips available



FIGURE B



▲ Contips available



FIGURE C

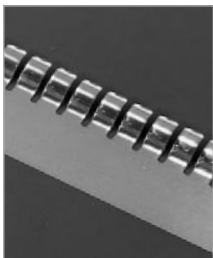

▲ Contips available on 97-111, 97-112, 97-114 and 97-116 only

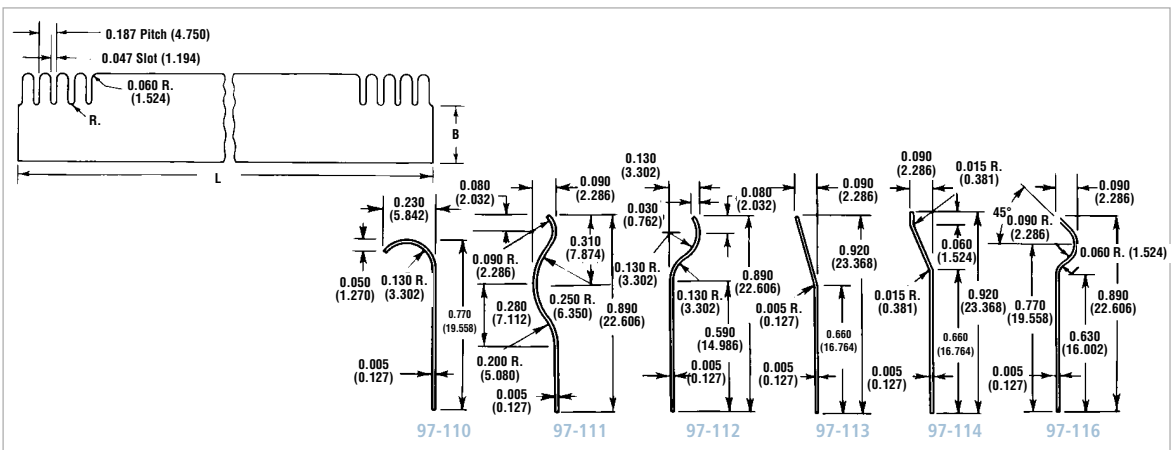

All dimensions shown are in inches (millimeters) unless otherwise specified.



FIGURE D



⚠ Not available with Contips®

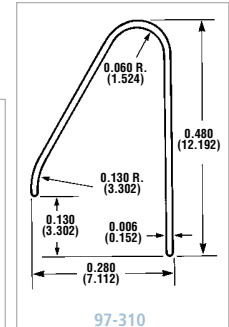
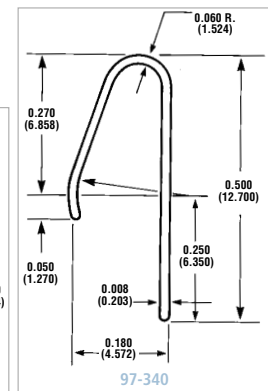

FIGURE E



⚠ Not available with Contips



FLAT STRIP

SERIES	FIG.	PITCH	SLOT	B	APPROX. LENGTH (L)	APPROX. NO. OF FINGERS
97-105	B	0.187 (4.750)	0.047 (1.194)	—	16.000 (406.400)	86
97-110	C	0.187 (4.750)	0.047 (1.194)	0.590 (14.986)	16.000 (406.400)	86
97-111	C	0.187 (4.750)	0.047 (1.194)	0.630 (16.002)	16.000 (406.400)	86
97-112	C	0.187 (4.750)	0.047 (1.194)	0.570 (14.478)	16.000 (406.400)	86
97-113	C	0.187 (4.750)	0.047 (1.194)	0.630 (16.002)	16.000 (406.400)	86
97-114	C	0.187 (4.750)	0.047 (1.194)	0.650 (16.510)	16.000 (406.400)	86
97-115	B	0.187 (4.750)	0.047 (1.194)	—	16.000 (406.400)	86
97-116	C	0.187 (4.750)	0.047 (1.194)	0.630 (16.002)	16.000 (406.400)	86

SERIES	FIG.	PITCH	SLOT	B	APPROX. LENGTH (L)	APPROX. NO. OF FINGERS
97-117	A	0.187 (4.750)	0.047 (1.194)	—	16.000 (406.400)	86
97-135	E	0.135 (3.429)	0.040 (1.016)	0.230 (5.842)	16.000 (406.400)	119
97-221	D	0.060 (1.524)	0.020 (0.508)	0.090 (2.286)	12.000 (304.800)	200
97-251	D	0.127 (3.226)	0.050 (1.270)	0.090 (2.286)	12.000 (304.800)	95
97-300	A	0.165 (4.191)	0.040 (1.016)	0.190 (4.826)	16.000 (406.400)	97
97-310	D	0.187 (4.750)	0.062 (1.575)	0.380 (9.652)	15.000 (381.000)	86
97-313	E	0.187 (4.750)	0.062 (1.575)	0.295 (7.493)	16.000 (406.400)	86
97-340	E	0.163 (4.140)	0.020 (0.508)	0.250 (6.350)	16.000 (406.400)	98
97-390	E	0.134 (3.404)	0.040 (1.016)	0.230 (5.842)	16.000 (406.400)	119

All dimensions shown are in inches (millimeters) unless otherwise specified.



FIGURE F



Contips® available

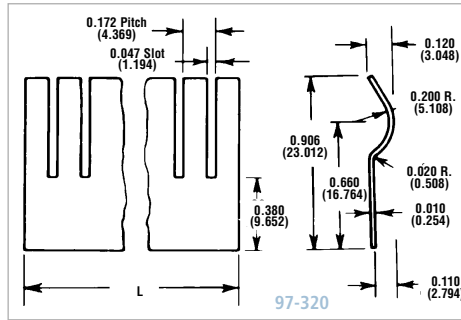

FIGURE G



Contips available



FIGURE H



Contips available



FIGURE I

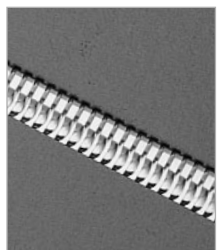

Contips available

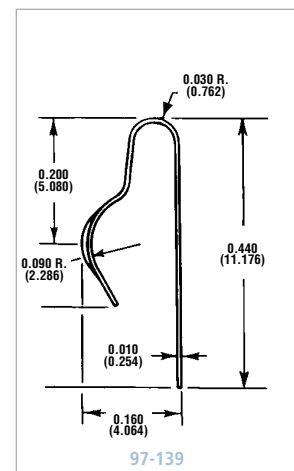
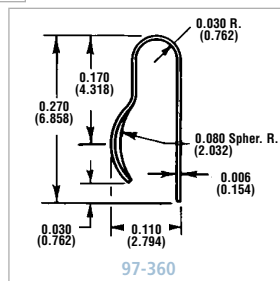
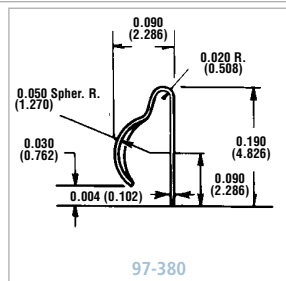
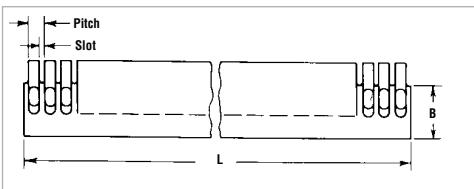

All dimensions shown are in inches (millimeters) unless otherwise specified.



FIGURE J



⚠ Not available with Contips®

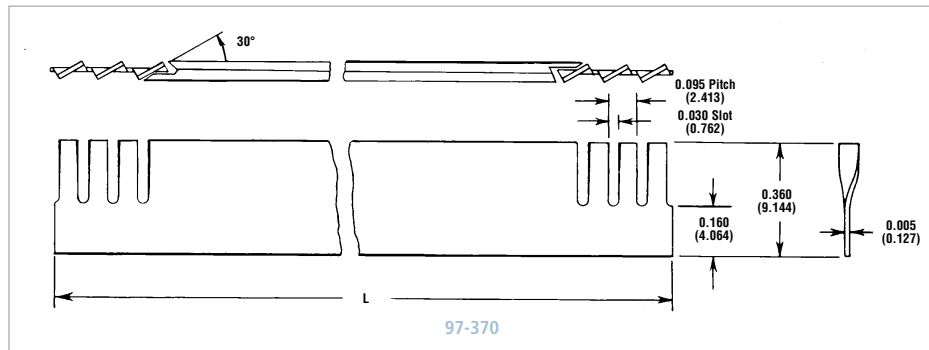

FIGURE K



⚠ Contips available

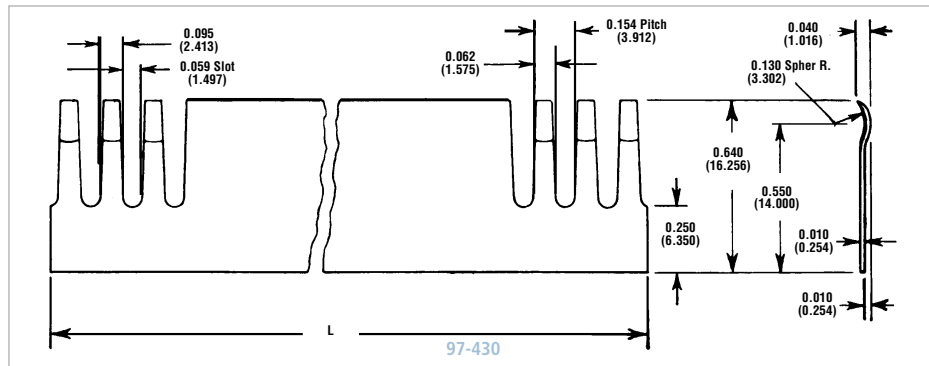
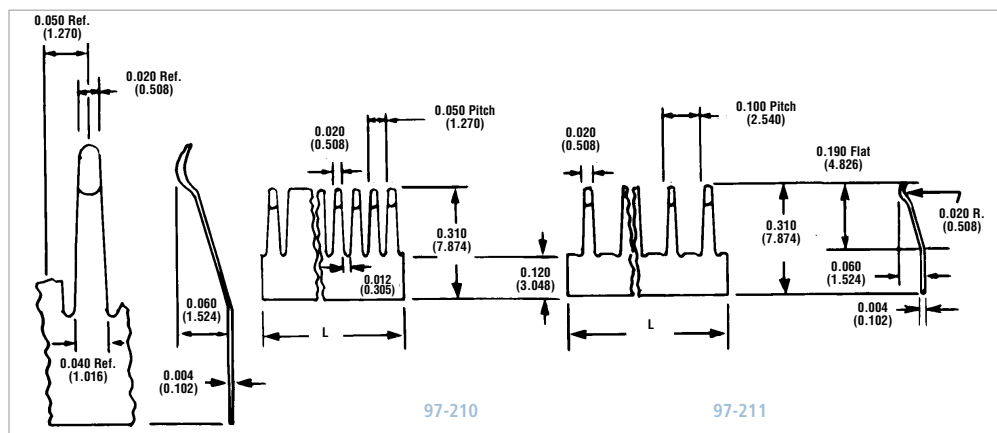

FIGURE L



⚠ Contips available



FLAT STRIP

SERIES	FIG.	PITCH	SLOT	B	APPROX. LENGTH (L)	APPROX. NO. OF FINGERS
97-134	H	0.075 (1.905)	0.025 (0.635)	0.220 (5.588)	16.000 (406.400)	213
97-136	H	0.075 (1.905)	0.025 (0.635)	0.060 (1.524)	16.000 (406.400)	213
97-137	H	0.094 (2.388)	0.031 (0.787)	0.310 (7.874)	16.000 (406.400)	170
97-139	I	0.094 (2.388)	0.031 (0.787)	0.310 (7.874)	16.000 (406.400)	170
97-210	L	0.050 (1.270)	0.012 (0.305)	0.120 (3.048)	12.000 (304.800)	240
97-211	L	0.100 (2.540)	0.062 (1.575)	0.120 (3.048)	12.000 (304.800)	120
97-223	H	0.060 (1.524)	0.020 (0.508)	0.130 (3.302)	16.000 (406.400)	267

SERIES	FIG.	PITCH	SLOT	B	APPROX. LENGTH (L)	APPROX. NO. OF FINGERS
97-290	H	0.075 (1.905)	0.025 (0.635)	0.690 (17.526)	16.000 (406.400)	213
97-320	F	0.172 (4.369)	0.047 (1.194)	0.380 (9.652)	16.000 (406.400)	93
97-330	G	0.075 (1.905)	0.025 (0.635)	-	16.000 (406.400)	213
97-360	I	0.075 (1.905)	0.025 (0.635)	0.220 (5.588)	16.000 (406.400)	213
97-370	J	0.095 (2.413)	0.030 (0.762)	-	16.000 (406.400)	168
97-380	I	0.060 (1.524)	0.020 (0.508)	0.130 (3.302)	16.000 (406.400)	267
97-410	F	0.157 (3.988)	0.040 (1.016)	0.340 (8.636)	16.000 (406.400)	102
97-430	K	0.154 (3.912)	0.059 (1.499)	0.250 (6.350)	16.000 (406.400)	104

All dimensions shown are in inches (millimeters) unless otherwise specified.



The large variety of sizes and shapes of contact rings offers engineers a wide choice in meeting design requirements for microwave cavities, tuning, shielding and grounding applications. Rings are made from strip stock formed into an unclosed circle which, when assembled, becomes a complete ring. These rings are furnished in any diameter, greater than the minimum shown in the chart below, and must contain an integral number of fingers.

Most configurations are available with Contips®, described in the preceding section.

Available in standard finishes, see page 1-11.

FEMALE RINGS

SERIES	PITCH	SLOT	OD	# OF FINGERS	REC. PIN DIAMETER	B	MADE FROM STRIP	SMALL DIA. FROM STRIP
97-070	0.135 (3.429)	0.040 (1.016)	1.219 (30.963)	28	0.980 (24.892)	0.234 (5.944)	97-135	0.570 (14.478)
97-072	0.135 (3.429)	0.040 (1.016)	1.000 (25.400)	23	0.790 (20.066)	0.234 (5.944)	97-135	0.570 (14.478)
97-074	0.135 (3.429)	0.040 (1.016)	0.875 (22.225)	20	0.672 (17.069)	0.234 (5.944)	97-135	0.570 (14.478)
97-076	0.163 (4.140)	0.020 (0.508)	0.640 (16.256)	12	0.340 (8.636)	0.250 (6.350)	97-340	0.640 (16.256)
97-140	0.075 (1.905)	0.025 (0.635)	0.290 (7.366)	12	0.250 (6.350)	0.220 (5.588)	97-134	0.200 (5.080)
97-141	0.075 (1.905)	0.025 (0.635)	0.440 (11.176)	18	0.380 (9.652)	0.220 (5.588)	97-134	0.200 (5.080)
97-142	0.075 (1.905)	0.025 (0.635)	0.550 (13.970)	23	0.500 (12.700)	0.220 (5.588)	97-134	0.200 (5.080)
97-143	0.075 (1.905)	0.025 (0.635)	0.800 (20.320)	33	0.750 (19.050)	0.220 (5.588)	97-134	0.200 (5.080)
97-185	0.075 (1.905)	0.025 (0.635)	0.560 (14.224)	23	0.500 (12.700)	0.060 (1.524)	97-136	0.200 (5.080)
97-204	0.094 (2.388)	0.031 (0.787)	1.040 (26.416)	34	1.000 (25.400)	0.310 (7.874)	97-137	0.460 (11.684)
97-216	0.094 (2.388)	0.031 (0.787)	1.240 (31.496)	41	1.000 (25.400)	0.300 (7.620)	97-139	0.940 (23.876)
97-232	0.060 (1.524)	0.020 (0.508)	0.540 (13.716)	28	0.500 (12.700)	0.130 (3.302)	97-233	0.160 (4.064)
97-252	0.127 (3.226)	0.050 (1.270)	1.250 (31.750)	31	1.090 (27.686)	0.090 (2.286)	97-251	0.450 (11.430)
97-254	0.127 (3.226)	0.050 (1.270)	0.910 (23.114)	22	0.740 (18.796)	0.090 (2.286)	97-251	0.450 (11.430)
97-255	0.127 (3.226)	0.050 (1.270)	0.650 (16.510)	16	0.480 (12.192)	0.090 (2.286)	97-251	0.450 (11.430)
97-361	0.075 (1.905)	0.025 (0.635)	1.010 (25.654)	42	0.840 (21.336)	0.220 (5.588)	97-360	0.610 (15.494)
97-381	0.060 (1.524)	0.020 (0.508)	1.210 (30.734)	63	1.060 (26.924)	0.130 (3.302)	97-380	0.460 (11.684)
97-420	0.190 (4.826)	0.075 (1.905)	0.500 (12.700)	8	0.320 (8.128)	0.060 (1.524)	N/A	0.500 (12.700)
97-421	0.100 (2.540)	0.050 (1.270)	0.500 (12.700)	15	0.370 (9.398)	0.070 (1.778)	N/A	0.440 (11.176)
97-422	0.154 (3.912)	0.059 (1.499)	0.600 (15.240)	12	0.370 (9.398)	0.250 (6.350)	N/A	0.550 (13.970)
97-423	0.154 (3.912)	0.059 (1.499)	0.780 (19.812)	15	0.540 (13.716)	0.250 (6.350)	N/A	0.550 (13.970)
97-424	0.135 (3.429)	0.040 (1.016)	1.050 (26.670)	24	0.810 (20.574)	0.230 (5.842)	N/A	0.870 (22.098)

FEMALE RINGS



CONTIPS AVAILABLE



97-252 TO 255



97-76



97-422 TO 424



97-381



97-361



97-216



97-420



97-421



97-232



97-204



97-070, 072, 074

All dimensions shown are in inches (millimeters) unless otherwise specified.



MALE RINGS

SERIES	PITCH	SLOT	ID	≈ # OF FINGERS	REC. HOLE SIZE	B	MADE FROM STRIP
97-150	0.075 (1.905)	0.025 (0.635)	0.210 (5.334)	9	0.250 (6.350)	0.220 (5.588)	97-134
97-151	0.075 (1.905)	0.025 (0.635)	0.330 (8.382)	14	0.380 (9.652)	0.220 (5.588)	97-134
97-152	0.075 (1.905)	0.025 (0.635)	0.450 (11.430)	19	0.500 (12.700)	0.220 (5.588)	97-134
97-153	0.075 (1.905)	0.025 (0.635)	0.690 (17.526)	29	0.750 (19.050)	0.220 (5.588)	97-134
97-154	0.075 (1.905)	0.025 (0.635)	0.950 (24.130)	40	1.000 (25.400)	0.220 (5.588)	97-134
97-155	0.075 (1.905)	0.025 (0.635)	1.450 (36.830)	61	1.500 (38.100)	0.220 (5.588)	97-134
97-156	0.075 (1.905)	0.025 (0.635)	1.950 (49.530)	82	2.000 (50.800)	0.220 (5.588)	97-136
97-192	0.075 (1.905)	0.025 (0.635)	0.450 (11.430)	19	0.500 (12.700)	0.060 (1.524)	97-136
97-205	0.094 (2.388)	0.031 (0.787)	0.890 (22.606)	30	1.000 (25.400)	0.310 (7.874)	97-137
97-215	0.094 (2.388)	0.031 (0.787)	1.240 (31.496)	42	1.500 (38.100)	0.310 (7.874)	97-139
97-241	0.060 (1.524)	0.020 (0.508)	0.340 (8.636)	18	0.380 (9.652)	0.130 (3.302)	97-223

MALE RINGS

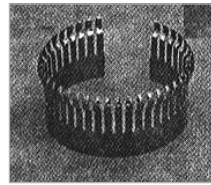

CONTIPS® AVAILABLE

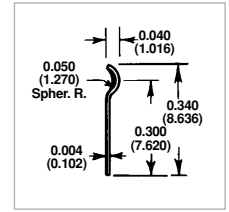
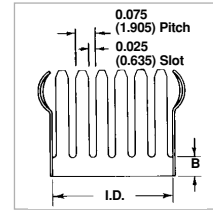

97-241

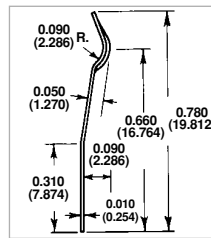

97-205

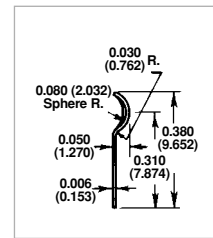

97-192

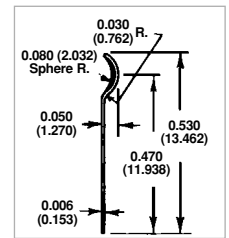

97-150 TO 156

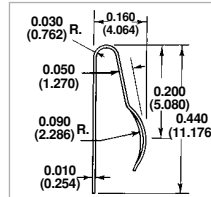

97-215

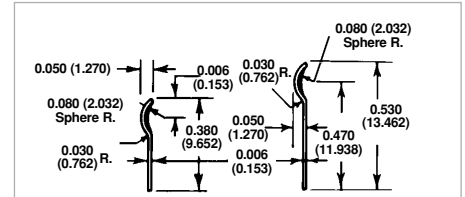

97-185

97-140 TO 143

FINGERSTOCK GASKETS AND METAL GROUNDING PRODUCTS
LOAD/DEFLECTION DATA



FINGERSTOCK LOAD DATA

Efficient enclosure design requires an understanding of the compression force necessary to close gasketed joints. Toward this end, Laird Technologies has developed the following charts indicating compression forces required to achieve optimum gasket performance from each of our fingerstock gaskets. Loads are expressed in "pounds per linear foot" (or as "kilograms per linear meter").

Load Tests: Bare BeCu mated against mild steel having a ground surface, roughness approx. 16 m in. (0.4 mm).

SAMPLE LOAD CHART FOR EMI GASKETS

PART NO.	LARGEST OPENING				DESIGN HEIGHT				SMALLEST OPENING	
	HEIGHT	LOAD	HEIGHT	LOAD	HEIGHT	LOAD	HEIGHT	LOAD	HEIGHT	LOAD
	INCHES	LB/FT	INCHES	LB/FT	INCHES	LB/FT	INCHES	LB/FT	INCHES	LB/FT
97-951	0.195 (4.953)	20 (30)	0.170 (4.318)	36 (53)	0.150 (3.810)	44 (65)	0.125 (3.175)	62 (92)	0.100 (2.540)	92 (137)



DEFINITIONS:

- Largest opening** is the height at which contact force is the minimum required for reliable shielding performance.
- Design height** is the height which allows maximum deviation in both directions. This is recommended in most cases.
- Smallest opening** is the smallest height which precludes damage to the gasket.

SHIELDING EFFECTIVENESS

Shielding effectiveness of fingerstock gaskets does not vary significantly with compression. The graph below shows finger gaskets tested at five different heights. Variation is only about 10 dB, which is typical of most fingerstock gaskets. Compression of a finger gasket beyond "design height" does not benefit performance, but can complicate enclosure design.

GROUNDING STRIPS

Some fingerstock products are used as grounding strips, or in other applications carrying RF current. Because these products are basically flat, their loads are expressed as a function of "deflection" rather than height.

SAMPLE LOAD CHART FOR GROUNDING STRIPS

PART NO.	SMALLEST DEFLECTION		DEFLECTION		DEFLECTION		DEFLECTION		LARGEST DEFLECTION	
	DEFLECTION	LOAD	DEFLECTION	LOAD	DEFLECTION	LOAD	DEFLECTION	LOAD	DEFLECTION	LOAD
	INCHES	LB/FT	INCHES	LB/FT	INCHES	LB/FT	INCHES	LB/FT	INCHES	LB/FT
97-116	0.010 (0.254)	11 (16)	0.020 (0.508)	22 (33)	0.035 (0.889)	44 (65)	0.045 (1.143)	62 (92)	0.055 (1.397)	84 (125)

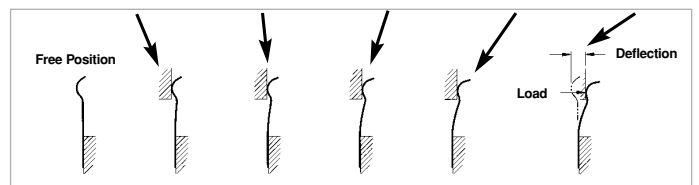

All dimensions shown are in inches (millimeters) unless otherwise specified.



EMI GASKETS										
PART NO.	LARGEST OPENING		HEIGHT		DESIGN HEIGHT		HEIGHT		SMALLEST OPENING	
	HEIGHT (MM)	LOAD (KG/M)	HEIGHT (MM)	LOAD (KG/M)	HEIGHT (MM)	LOAD (KG/M)	HEIGHT (MM)	LOAD (KG/M)	HEIGHT (MM)	LOAD (KG/M)
77-010	0.055 (1.397)	10 (15)	0.045 (1.143)	21 (31.5)	0.035 (0.889)	34 (51)	0.025 (0.635)	47 (70.5)	0.015 (0.381)	62 (93)
77-011	12 (3.048)	12 (18)	0.095 (2.413)	29 (43.5)	0.070 (1.778)	48 (72)	0.045 (1.143)	74 (111)	0.020 (0.508)	121 (181.5)
77-012	.100 (2.540)	5 (7.5)	0.085 (2.159)	13 (19.5)	0.075 (1.905)	16 (24)	0.060 (1.524)	23 (34.5)	0.050 (1.270)	37 (55.5)
77-014	0.195 (4.953)	9 (13.5)	0.170 (4.318)	17 (25.5)	0.140 (3.556)	25 (37.5)	0.115 (2.921)	32 (48)	0.090 (2.286)	44 (66)
77-023	0.069 (1.753)	0.19 (0.285)	0.058 (1.473)	0.41 (0.615)	0.047 (1.194)	0.67 (1.005)	0.036 (0.914)	1 (1.5)	0.025 (0.635)	1.3 (1.95)
77-024	0.069 (1.753)	0.19 (0.285)	0.058 (1.473)	0.41 (0.615)	0.047 (1.194)	0.67 (1.005)	0.036 (0.914)	1 (1.5)	0.025 (0.635)	1.3 (1.95)
77-025	0.069 (1.753)	0.19 (0.285)	0.058 (1.473)	0.41 (0.615)	0.047 (1.194)	0.67 (1.005)	0.036 (0.914)	1 (1.5)	0.025 (0.635)	1.3 (1.95)
77-026	0.069 (1.753)	0.19 (0.285)	0.058 (1.473)	0.41 (0.615)	0.047 (1.194)	0.67 (1.005)	0.036 (0.914)	1 (1.5)	0.025 (0.635)	1.3 (1.95)
77-027	0.069 (1.753)	0.19 (0.285)	0.058 (1.473)	0.41 (0.615)	0.047 (1.194)	0.67 (1.005)	0.036 (0.914)	1 (1.5)	0.025 (0.635)	1.3 (1.95)
77-033	0.099 (2.515)	7.5 (11.25)	0.083 (2.108)	16 (24)	0.068 (1.727)	23 (34.5)	0.052 (1.321)	29.2 (43.8)	0.036 (0.914)	86 (129)
77-035	0.063 (1.600)	0.2 (0.3)	0.051 (1.295)	0.5 (0.75)	0.039 (0.991)	0.9 (1.35)	0.027 (0.686)	1.3 (1.95)	0.015 (0.381)	1.8 (2.7)
EMI GROUNDING STRIPS										
PART NO.	SMALLEST DEFLECTION		DEFLECTION		DEFLECTION		DEFLECTION		LARGEST DEFLECTION	
	DEFLECTION (MM)	LOAD (KG/M)	DEFLECTION (MM)	LOAD (KG/M)	DEFLECTION (MM)	LOAD (KG/M)	DEFLECTION (MM)	LOAD (KG/M)	DEFLECTION (MM)	LOAD (KG/M)
97-110	0.020 (0.508)	6 (9)	0.040 (1.016)	17 (25)	0.060 (1.524)	30 (45)	0.080 (2.032)	46 (68)	0.100 (2.540)	72 (107)
97-111	0.020 (0.508)	1 (1.5)	0.045 (1.143)	1.9 (2.8)	0.065 (1.651)	2.7 (4)	0.090 (2.286)	3.9 (5.8)	0.110 (2.794)	4.9 (7.3)
97-112	0.020 (0.508)	8 (11)	0.040 (1.016)	17 (25)	0.055 (1.397)	24 (36)	0.075 (1.905)	37 (54)	0.095 (2.413)	53 (79)
97-113	0.015 (0.381)	2 (3)	0.030 (0.762)	4.4 (6.5)	0.040 (1.016)	5.9 (8.8)	0.055 (1.397)	8.3 (12.4)	0.070 (1.778)	13.2 (19.6)
97-114	0.015 (0.381)	2.9 (4.3)	0.025 (0.635)	5.1 (7.6)	0.035 (0.889)	7.2 (10.7)	0.045 (1.143)	9.4 (14)	0.055 (1.397)	11.7 (17.4)
97-115	0.116 (2.946)	6 (8)	0.102 (2.591)	14 (21)	0.088 (2.235)	20 (29)	0.074 (1.880)	29 (42)	0.060 (1.524)	48 (71)
97-105	0.116 (2.946)	6 (8)	0.102 (2.591)	14 (21)	0.088 (2.235)	20 (29)	0.074 (1.880)	29 (42)	0.060 (1.524)	48 (71)
97-116	0.010 (0.254)	11 (16)	0.020 (0.508)	22 (33)	0.035 (0.889)	44 (65)	0.045 (1.143)	62 (92)	0.055 (1.397)	84 (125)
97-117	0.025 (0.635)	1.8 (2.7)	0.045 (1.143)	4.9 (7.3)	0.070 (1.778)	9.6 (14.3)	0.090 (2.286)	13.9 (20.7)	0.115 (2.921)	19.5 (29)
97-134	0.010 (0.254)	4.8 (7.1)	0.015 (0.381)	6.9 (10.3)	0.020 (0.508)	9.8 (14.6)	0.025 (0.635)	12.7 (18.9)	0.030 (0.762)	16.3 (24.3)
97-135	0.126 (3.200)	18 (27)	0.122 (3.099)	44 (65)	0.118 (2.997)	72 (107)	0.114 (2.900)	109 (162)	0.110 (2.794)	142 (211)
97-136	0.005 (0.127)	7 (10)	0.010 (0.254)	14 (20)	0.015 (0.381)	22 (32)	0.020 (0.508)	29 (43)	0.025 (0.635)	36 (54)
97-137	0.015 (0.381)	7 (10)	0.025 (0.635)	13 (19)	0.040 (1.016)	21 (31)	0.050 (1.270)	26 (38)	0.065 (1.651)	32 (48)
97-139	0.148 (3.759)	24 (36)	0.136 (3.454)	52 (77)	0.124 (3.150)	79 (118)	0.112 (2.845)	108 (161)	0.100 (2.540)	140 (208)
97-210	0.010 (0.254)	4 (6)	0.020 (0.508)	8 (11)	0.030 (0.762)	11 (16)	0.040 (1.016)	14 (21)	0.050 (1.270)	16 (24)
97-211	0.010 (0.254)	1.8 (2.7)	0.020 (0.508)	3.8 (5.7)	0.030 (0.762)	5.8 (8.6)	0.040 (1.016)	7.8 (11.6)	0.050 (1.270)	9.9 (14.7)
97-221	0.067 (1.702)	18 (27)	0.064 (1.626)	31 (46)	0.061 (1.549)	51 (76)	0.058 (1.473)	66 (98)	0.055 (1.397)	85 (126)
97-223	0.004 (0.102)	0.7 (1.0)	0.008 (0.203)	2.1 (3.1)	0.012 (0.305)	3.3 (4.9)	0.016 (0.406)	4.8 (7.1)	0.020 (0.508)	6.1 (9.1)
97-251	0.087 (2.210)	30 (45)	0.084 (2.134)	58 (86)	0.081 (2.057)	87 (129)	0.078 (1.981)	117 (174)	0.075 (1.905)	136 (202)

EMI GASKETS										
PART NO.	LARGEST OPENING		HEIGHT		DESIGN HEIGHT		HEIGHT		SMALLEST OPENING	
	HEIGHT (MM)	LOAD (KG/M)	HEIGHT (MM)	LOAD (KG/M)	HEIGHT (MM)	LOAD (KG/M)	HEIGHT (MM)	LOAD (KG/M)	HEIGHT (MM)	LOAD (KG/M)
97-290	0.007 (0.178)	3 (4)	0.014 (0.356)	7 (10)	0.022 (0.559)	16 (23)	0.029 (0.737)	25 (37)	0.036 (0.914)	34 (50)
97-300	0.020 (0.508)	4.6 (6.8)	0.040 (1.016)	9 (13.4)	0.060 (1.524)	14 (20.8)	0.080 (2.032)	19 (28.3)	0.100 (2.540)	25.4 (37.8)
97-310	0.255 (6.477)	3 (4.5)	0.230 (5.842)	6.5 (9.7)	0.200 (5.080)	10.5 (15.6)	0.175 (4.445)	14 (20.8)	0.150 (3.810)	25 (37.2)
97-320	0.015 (0.381)	31 (46)	0.025 (0.635)	52 (77)	0.040 (1.016)	88 (131)	0.050 (1.270)	118 (176)	0.065 (1.651)	158 (235)
97-340	0.170 (4.318)	10 (15)	0.160 (4.064)	22 (33)	0.145 (3.683)	52 (77)	0.135 (3.429)	91 (135)	0.125 (3.175)	168 (250)
97-360	0.102 (2.591)	19 (28)	0.094 (2.388)	19 (28)	0.086 (2.184)	30 (45)	0.078 (1.981)	41 (60)	0.070 (1.778)	78 (116)
97-370	0.028 (0.711)	34 (51)	0.025 (0.635)	64 (95)	0.023 (0.584)	94 (140)	0.020 (0.508)	132 (196)	0.018 (0.457)	156 (232)
97-380	0.084 (2.133)	10 (15)	0.078 (1.981)	19 (28)	0.072 (1.829)	30 (45)	0.066 (1.676)	40 (59)	0.060 (1.524)	53 (79)
97-390	0.193 (4.902)	23 (34)	0.186 (4.724)	55 (82)	0.179 (4.547)	90 (134)	0.172 (4.369)	138 (205)	0.165 (4.191)	183 (272)
97-410	0.040 (1.016)	5 (7)	0.080 (2.032)	10 (14)	0.120 (3.048)	18 (27)	0.160 (4.064)	29 (43)	0.200 (5.080)	42 (62)
97-430	.008 (0.203)	6 (8.93)	0.016 (0.406)	12 (17.86)	0.024 (0.609)	18 (26.79)	0.032 (0.813)	29 (43.16)	0.042 (1.016)	42 (62.50)
97-435	0.210 (5.334)	1.1 (1.6)	0.175 (4.445)	3 (4.4)	0.135 (3.429)	3.1 (4.6)	0.100 (2.540)	4 (6)	0.060 (1.524)	5.2 (7.7)
97-436	0.210 (5.334)	4 (6)	0.175 (4.445)	7.5 (11.2)	0.135 (3.429)	11.5 (17.1)	0.100 (2.540)	14.8 (22)	0.060 (1.524)	19.2 (28.6)
97-438	0.215 (5.461)	10 (15)	0.180 (4.572)	22 (33)	0.145 (3.683)	32 (48)	0.110 (2.794)	42 (62)	0.075 (1.905)	60 (89)
97-440	0.350 (8.890)	17 (25)	0.290 (7.366)	31 (46)	0.230 (5.842)	41 (61)	0.160 (4.064)	51 (75)	0.100 (2.540)	64 (95)
97-500	0.190 (4.826)	16 (24)	0.155 (3.937)	26 (39)	0.115 (2.921)	35 (52)	0.080 (2.032)	44 (65)	0.040 (1.016)	53 (78)
97-505	0.195 (4.953)	16 (24)	0.160 (4.064)	27 (40)	0.130 (3.302)	35 (52)	0.095 (2.413)	43 (63)	0.060 (1.524)	55 (81)
97-510	0.200 (5.080)	14 (21)	0.175 (4.445)	25 (37)	0.145 (3.683)	42 (62)	0.120 (3.048)	66 (98)	0.090 (2.286)	132 (196)
97-515	0.195 (4.953)	16 (23)	0.160 (4.064)	27 (40)	0.130 (3.302)	34 (50)	0.095 (2.413)	40 (60)	0.060 (1.524)	52 (77)
97-520	0.125 (3.175)	18 (27)	0.110 (2.794)	32 (48)	0.100 (2.540)	39 (58)	0.085 (2.159)	49 (73)	0.070 (1.778)	59 (88)
97-521	0.125 (3.175)	16 (24)	0.110 (2.794)	28 (42)	0.100 (2.540)	36 (54)	0.085 (2.159)	47 (70)	0.070 (1.778)	59 (88)
97-525	0.126 (3.200)	18 (27)	0.112 (2.845)	35 (52)	0.098 (2.489)	49 (73)	0.084 (2.134)	59 (88)	0.070 (1.778)	68 (101)
97-535	0.215 (5.461)	20 (29)	0.180 (4.572)	32 (48)	0.150 (3.810)	42 (62)	0.115 (2.921)	52 (77)	0.080 (2.032)	64 (95)
97-536	0.275 (6.985)	21 (31)	0.240 (6.096)	26 (38)	0.210 (5.334)	49 (73)	0.175 (4.445)	56 (83)	0.140 (3.556)	62 (92)
97-537	0.350 (8.890)	27 (40)	0.290 (7.366)	47 (69)	0.230 (5.842)	62 (92)	0.160 (4.064)	72 (107)	0.100 (2.540)	87 (129)
97-538	0.215 (5.461)	14 (20)	0.180 (4.572)	27 (40)	0.150 (3.810)	36 (54)	0.115 (2.921)	47 (69)	0.080 (2.032)	65 (97)
97-540	0.100 (2.540)	18 (27)	0.090 (2.286)	20 (30)	0.080 (2.032)	45 (66)	0.075 (1.905)	52 (77)	0.065 (1.651)	62 (92)
97-541	0.106 (2.692)	23 (34)	0.092 (2.337)	42 (62)	0.078 (1.981)	56 (83)	0.064 (1.626)	67 (100)	0.050 (1.270)	87 (129)
97-542	0.074 (1.888)	36 (53)	0.068 (1.727)	63 (94.5)	0.062 (1.575)	80 (120)	0.056 (1.422)	91 (132)	0.050 (1.270)	97 (144)
97-544	0.100 (2.540)	11 (16)	0.090 (2.286)	24 (36)	0.080 (2.032)	37 (55)	0.075 (1.905)	43 (63)	0.065 (1.651)	55 (81)
97-545	0.350 (8.890)	8 (12)	0.285 (7.239)	20 (30)	0.225 (5.715)	37 (55)	0.160 (4.064)	70 (105)	0.100 (2.540)	101 (152)

All dimensions shown are in inches (millimeters) unless otherwise specified.



EMI GASKETS (continued)

PART NO.	LARGEST OPENING		DESIGN HEIGHT				SMALLEST OPENING			
	HEIGHT INCHES (MM)	LOAD LB/FT (KG/M)	HEIGHT INCHES (MM)	LOAD LB/FT (KG/M)	HEIGHT INCHES (MM)	LOAD LB/FT (KG/M)	HEIGHT INCHES (MM)	LOAD LB/FT (KG/M)		
97-548	0.220 (5.588)	12 (18)	0.190 (4.826)	23 (34)	0.160 (4.064)	33 (49)	0.130 (3.302)	58 (87)	0.100 (2.540)	108 (162)
97-550	0.026 (0.660)	8 (12)	0.022 (0.559)	18 (27)	0.018 (0.457)	25 (37)	0.014 (0.356)	33 (49)	0.010 (0.254)	48 (71)
97-551	0.026 (0.660)	6 (9)	0.022 (0.559)	14 (20)	0.018 (0.457)	21 (31)	0.014 (0.356)	32 (48)	0.010 (0.254)	42 (62)
97-552	0.026 (0.660)	11 (16)	0.022 (0.559)	24 (36)	0.018 (0.457)	32 (48)	0.014 (0.356)	42 (62)	0.010 (0.254)	55 (82)
97-553	0.026 (0.660)	11 (16)	0.022 (0.559)	24 (36)	0.018 (0.457)	32 (48)	0.014 (0.356)	42 (62)	0.010 (0.254)	55 (82)
97-555	0.063 (1.600)	11 (16)	0.056 (1.422)	22 (33)	0.049 (1.245)	33 (49)	0.042 (1.067)	40 (60)	0.035 (0.889)	44 (65)
97-556	0.063 (1.600)	29 (42)	0.056 (1.422)	46 (68)	0.049 (1.245)	64 (94)	0.042 (1.067)	82 (123)	0.035 (0.889)	123 (184)
97-558	0.063 (1.600)	10 (15)	0.056 (1.422)	21 (31)	0.049 (1.245)	37 (55)	0.042 (1.067)	46 (68)	0.035 (0.889)	52 (77)
97-559	0.064 (1.625)	11 (16)	0.058 (1.473)	21 (31)	0.052 (1.321)	32 (48)	0.046 (1.168)	39 (58.5)	0.040 (1.016)	45 (67)
97-560	0.063 (1.600)	11 (16)	0.056 (1.422)	28 (42)	0.049 (1.245)	43 (64)	0.042 (1.067)	56 (83)	0.035 (0.889)	65 (97)
97-561	0.063 (1.600)	24 (36)	0.056 (1.422)	47 (69)	0.049 (1.245)	76 (114)	0.042 (1.067)	107 (160)	0.035 (0.889)	154 (231)
97-563	0.063 (1.600)	9 (13.5)	0.056 (1.422)	18 (27)	0.049 (1.245)	27 (40)	0.042 (1.067)	32 (48)	0.035 (0.889)	34 (51)
97-564	0.063 (1.600)	9 (13.5)	0.056 (1.422)	18 (27)	0.049 (1.245)	27 (40)	0.042 (1.067)	32 (48)	0.035 (0.889)	34 (51)
97-572	0.026 (0.660)	11 (16)	0.022 (0.559)	25 (37)	0.018 (0.457)	37 (55)	0.014 (0.356)	50 (75)	0.010 (0.254)	61 (91.5)
97-573	0.063 (1.600)	10 (15)	0.056 (1.422)	18 (27)	0.049 (1.245)	26 (39)	0.042 (1.067)	36 (53)	0.035 (0.889)	56 (83)
97-574	0.026 (0.660)	11 (16)	0.022 (0.559)	25 (37)	0.018 (0.457)	37 (55)	0.014 (0.356)	50 (74)	0.010 (0.254)	61 (91)
97-575	0.063 (1.600)	10 (15)	0.056 (1.422)	18 (27)	0.049 (1.245)	26 (39)	0.042 (1.067)	36 (53)	0.035 (0.889)	56 (83)
97-576	0.065 (1.651)	11 (17)	0.055 (1.397)	22 (33)	0.045 (1.143)	32 (47)	0.035 (0.889)	37 (54)	0.025 (0.635)	40 (60)
97-577	0.067 (1.702)	16 (24)	0.059 (1.497)	46 (68)	0.051 (1.295)	65 (97)	0.043 (1.092)	84 (125)	0.035 (0.889)	104 (155)
97-578	0.065 (1.651)	11 (17)	0.055 (1.397)	22 (33)	0.045 (1.143)	32 (47)	0.035 (0.889)	37 (54)	0.025 (0.640)	40 (60)
97-579	0.067 (1.702)	16 (24)	0.059 (1.497)	46 (68)	0.051 (1.295)	65 (97)	0.043 (1.092)	84 (125)	0.035 (0.889)	104 (155)
97-603	0.170 (4.318)	5 (7)	0.145 (3.683)	10 (15)	0.115 (2.921)	17 (25)	0.090 (2.286)	24 (36)	0.060 (1.524)	53 (78)
97-604	0.245 (6.223)	6 (9)	0.210 (5.334)	13 (19)	0.170 (4.318)	22 (33)	0.135 (3.429)	30 (45)	0.100 (2.540)	40 (60)
97-605	0.170 (4.318)	5 (7)	0.145 (3.683)	10 (15)	0.115 (2.921)	17 (25)	0.090 (2.286)	24 (36)	0.060 (1.524)	53 (78)
97-606	0.170 (4.318)	5 (7)	0.145 (3.683)	10 (15)	0.115 (2.921)	17 (25)	0.090 (2.286)	24 (36)	0.060 (1.524)	53 (78)
97-607	0.245 (6.223)	6 (9)	0.210 (5.334)	13 (19)	0.170 (4.318)	22 (33)	0.135 (3.429)	30 (45)	0.100 (2.540)	40 (60)
97-610	0.093 (2.362)	3 (4)	0.086 (2.184)	11 (16)	0.079 (2.107)	23 (34)	0.072 (1.829)	37 (55)	0.065 (1.651)	69 (103)
97-611	0.092 (2.337)	1 (1.5)	0.084 (2.134)	3 (4.5)	0.076 (1.930)	5.5 (8.2)	0.068 (1.727)	11 (16.4)	0.060 (1.524)	19 (28.3)
97-612	0.090 (2.286)	3 (4)	0.080 (2.032)	14 (21)	0.065 (1.651)	47 (69)	0.055 (1.397)	67 (100)	0.045 (1.143)	83 (124)
97-613	0.092 (2.337)	6 (9)	0.084 (2.134)	17 (25)	0.076 (1.930)	26 (39)	0.068 (1.727)	38 (57)	0.060 (1.524)	62 (92)
97-614	0.093 (2.362)	3 (4)	0.086 (2.184)	11 (16)	0.079 (2.007)	23 (34)	0.072 (1.829)	37 (55)	0.065 (1.651)	69 (103)
97-619	0.073 (1.854)	32 (48)	0.066 (1.676)	75 (112)	0.059 (1.499)	118 (176)	0.052 (1.321)	170 (253)	0.045 (1.143)	205 (305)
97-621	0.110 (2.794)	6 (9)	0.100 (2.540)	12 (17)	0.090 (2.286)	19 (28)	0.080 (2.032)	26 (39)	0.070 (1.778)	52 (77)

EMI GASKETS (continued)

PART NO.	LARGEST OPENING		DESIGN HEIGHT				SMALLEST OPENING			
	HEIGHT INCHES (MM)	LOAD LB/FT (KG/M)	HEIGHT INCHES (MM)	LOAD LB/FT (KG/M)	HEIGHT INCHES (MM)	LOAD LB/FT (KG/M)	HEIGHT INCHES (MM)	LOAD LB/FT (KG/M)		
97-622	0.110 (2.794)	8 (12)	0.100 (2.540)	18 (27)	0.095 (2.413)	21 (31)	0.085 (2.159)	30 (45)	0.075 (1.905)	45 (67)
97-625	0.165 (4.191)	5 (7)	0.140 (3.556)	11 (16)	0.120 (3.048)	16 (24)	0.095 (2.413)	23 (34)	0.070 (1.778)	30 (45)
97-628	0.180 (4.572)	3 (4)	0.155 (3.937)	6 (9)	0.125 (3.175)	11 (16)	0.100 (2.540)	16 (24)	0.070 (1.778)	25 (37)
97-629	0.180 (4.572)	3 (4)	0.155 (3.937)	6 (9)	0.125 (3.175)	11 (16)	0.100 (2.540)	16 (24)	0.070 (1.778)	25 (37)
97-630	0.180 (4.572)	3 (4)	0.155 (3.937)	6 (9)	0.125 (3.175)	11 (16)	0.100 (2.540)	16 (24)	0.070 (1.778)	25 (37)
97-631	0.185 (4.699)	3 (4)	0.160 (4.064)	6 (9)	0.130 (3.302)	11 (16)	0.105 (2.667)	17 (25)	0.080 (2.032)	36 (53)
97-632	0.185 (4.699)	3 (4)	0.160 (4.064)	6 (9)	0.130 (3.302)	11 (16)	0.105 (2.667)	16 (23)	0.080 (2.032)	37 (55)
97-633	0.185 (4.699)	3 (4)	0.160 (4.064)	6 (9)	0.130 (3.302)	11 (16)	0.105 (2.667)	17 (25)	0.080 (2.032)	36 (53)
97-634	0.185 (4.699)	3 (4)	0.160 (4.064)	6 (9)	0.130 (3.302)	11 (16)	0.105 (2.667)	16 (23)	0.080 (2.032)	37 (55)
97-637	0.095 (2.413)	18.3 (27.4)	.086 (2.184)	29.6 (44.4)	.078 (1.981)	40.7 (61)	.069 (1.752)	52.9 (79.4)	.060 (1.524)	66.7 (100.5)
97-640	0.220 (5.588)	12 (18)	0.180 (4.572)	25 (37)	0.140 (3.566)	36 (54)	0.100 (2.540)	46 (68)	0.060 (1.524)	64 (94)
97-645	0.026 (0.660)	3 (4.5)	0.022 (0.559)	6 (8.9)	0.018 (0.457)	7 (10.4)	0.014 (0.356)	9.5 (14.1)	0.010 (0.254)	15 (22.3)
97-650	0.360 (9.144)	9 (13)	0.320 (8.128)	15 (22)	0.280 (7.112)	25 (37)	0.240 (6.096)	32 (48)	0.200 (5.080)	41 (60)
97-654	0.026 (0.660)	0.03 (0.4)	0.023 (0.584)	0.6 (0.9)	0.021 (0.533)	0.8 (1.2)	0.018 (0.457)	1.1 (1.65)	0.015 (0.381)	1.3 (1.95)
97-655	0.080 (2.032)	4 (6)	0.070 (1.778)	8 (12)	0.060 (1.524)	17 (25)	0.050 (1.270)	27 (40)	0.040 (1.016)	37 (55)
97-656	0.200 (5.080)	5.5 (8.2)	0.170 (4.318)	10.5 (15.6)	0.140 (3.556)	12.5 (18.6)	0.110 (2.794)	16.5 (24.6)	0.080 (2.032)	24.5 (36.5)
97-880	0.230 (5.842)	3 (4)	0.210 (5.334)	9 (13)	0.190 (4.826)	16 (24)	0.170 (4.318)	29 (43)	0.150 (3.810)	43 (63)
97-883	0.230 (5.842)	4 (6)	0.210 (5.334)	11 (16)	0.190 (4.826)	18 (27)	0.170 (4.318)	29 (42)	0.150 (3.810)	41 (60)
97-885	0.230 (5.842)	6 (9)	0.210 (5.334)	13 (19)	0.190 (4.826)	19 (28)	0.170 (4.318)	31 (46)	0.150 (3.810)	48 (71)
97-887	0.230 (5.842)	6 (9)	0.210 (5.334)	13 (19)	0.190 (4.826)	19 (28)	0.170 (4.318)	31 (46)	0.150 (3.810)	48 (71)
97-912	0.224 (5.690)	6 (8.9)	0.193 (4.902)	9.5 (14.1)	0.161 (4.089)	14.5 (21.6)	0.130 (3.302)	21 (31.2)	0.098 (2.489)	28 (41.7)
97-921	0.210 (5.334)	2.5 (3.7)	0.185 (4.699)	4.3 (6.4)	0.165 (4.191)	6.6 (9.8)	0.140 (3.556)	9.6 (14.3)	0.120 (3.048)	13.7 (20.4)
97-941	0.155 (3.937)	4.2 (6.2)	0.140 (3.556)	7.4 (11)	0.120 (3.048)	12.1 (18)	0.105 (2.667)	14.8 (22)	0.090 (2.286)	17.2 (25.6)
97-951	0.195 (4.953)	20 (30)	0.170 (4.318)	36 (53)	0.150 (3.810)	44 (65)	0.125 (3.175)	62 (92)	0.100 (2.540)	92 (137)
97-952	0.195 (4.953)	16 (24)	0.170 (4.318)	25 (37)	0.150 (3.810)	33 (49)	0.125 (3.175)	47 (70)	0.100 (2.540)	74 (110)
97-954	0.126 (3.200)	9 (13)	0.112 (2.845)	18 (26)	0.098 (2.489)	24 (36)	0.084 (2.134)	31 (46)	0.070 (1.778)	46 (68)
97-955	0.126 (3.200)	11 (16)	0.112 (2.845)	21 (31)	0.098 (2.489)	28 (42)	0.084 (2.134)	37 (55)	0.070 (1.778)	62 (92)
97-957	0.100 (2.540)	13 (19)	0.090 (2.286)	26 (39)	0.080 (2.032)	37 (55)	0.065 (1.651)	65 (97)	0.055 (1.397)	102 (152)
97-958	0.102 (2.591)	8 (12)	0.094 (2.388)	17 (25)	0.086 (2.184)	26 (39)	0.078 (1.981)	40 (60)	0.070 (1.778)	57 (84)
97-974	0.130 (3.302)	0.8 (1.2)	0.110 (2.794)	1.5 (2.2)	0.090 (2.286)	2.5 (3.7)	0.070 (1.778)	3.6 (5.4)	0.050 (1.270)	5.1 (7.6)
97-975	0.260 (6.604)	4.2 (6.2)	0.210 (5.334)	7.7 (11.5)	0.160 (4.064)	11.3 (16.8)	0.120 (3.048)	14 (20.8)	0.070 (1.778)	18.8 (28)
97-976	0.145 (3.683)	1.4 (2.1)	0.115 (2.921)	3.1 (4.6)	0.080 (2.032)	5 (7.4)	0.050 (1.270)	6.6 (9.8)	0.020 (0.508)	8.9 (13.2)

All dimensions shown are in inches (millimeters) unless otherwise specified.





ULTRASOFT GASKETS

PART NO.	LARGEST OPENING		HEIGHT		DESIGN HEIGHT		HEIGHT		SMALLEST OPENING	
	HEIGHT	LOAD	HEIGHT	LOAD	HEIGHT	LOAD	HEIGHT	LOAD	HEIGHT	LOAD
	INCHES (MM)	LB/FT (KG/M)	INCHES (MM)	LB/FT (KG/M)	INCHES (MM)	LB/FT (KG/M)	INCHES (MM)	LB/FT (KG/M)	INCHES (MM)	LB/FT (KG/M)
78-010	0.056 (1.422)	3.4 (5.1)	0.044 (1.118)	7.5 (11.25)	0.033 (0.838)	11.5 (17.25)	0.021 (0.533)	16.7 (25.05)	0.010 (0.254)	22 (33)
78-011	0.120 (3.048)	2.3 (3.45)	0.090 (2.286)	5.7 (8.55)	0.065 (1.651)	9.2 (13.8)	0.040 (1.016)	15 (22.5)	0.015 (0.381)	25.5 (38.25)
78-014	0.195 (4.953)	1.6 (2.4)	0.170 (4.318)	3.1 (4.65)	0.140 (3.556)	4.5 (6.75)	0.115 (2.921)	5.4 (8.1)	0.090 (2.286)	7.4 (11.1)
78-023	0.067 (1.702)	0.06 (0.09)	0.054 (1.372)	0.12 (0.18)	0.041 (1.041)	0.18 (0.27)	0.028 (0.711)	0.25 (0.375)	0.015 (0.381)	0.34 (0.51)
78-025	0.067 (1.702)	0.06 (0.09)	0.054 (1.372)	0.12 (0.18)	0.041 (1.041)	0.18 (0.27)	0.028 (0.711)	0.25 (0.375)	0.015 (0.381)	0.34 (0.51)
78-026	0.067 (1.702)	0.06 (0.09)	0.054 (1.372)	0.12 (0.18)	0.041 (1.041)	0.18 (0.27)	0.028 (0.711)	0.25 (0.375)	0.015 (0.381)	0.34 (0.51)
78-027	0.067 (1.702)	0.06 (0.09)	0.054 (1.372)	0.12 (0.18)	0.041 (1.041)	0.18 (0.27)	0.028 (0.711)	0.25 (0.375)	0.015 (0.381)	0.34 (0.51)
78-033	0.099 (2.515)	7.5 (11.25)	0.083 (2.108)	16 (24)	0.068 (1.727)	23 (34.5)	0.052 (1.321)	29.2 (43.8)	0.036 (0.914)	86 (129)
78-036	0.063 (1.600)	0.09 (0.135)	0.051 (1.295)	0.18 (0.27)	0.039 (0.991)	0.29 (0.435)	0.027 (0.686)	0.4 (0.6)	0.015 (0.381)	0.6 (0.9)

ULTRASOFT GROUNDING STRIPS

PART NO.	SMALLEST DEFLECTION		DEFLECTION		LOAD		DEFLECTION		LOAD		LARGEST DEFLECTION	
	DEFLECTION	LOAD	DEFLECTION	LOAD	DEFLECTION	LOAD	DEFLECTION	LOAD	DEFLECTION	LOAD	DEFLECTION	LOAD
	INCHES (MM)	LB/FT (KG/M)	INCHES (MM)	LB/FT (KG/M)	INCHES (MM)	LB/FT (KG/M)	INCHES (MM)	LB/FT (KG/M)	INCHES (MM)	LB/FT (KG/M)	INCHES (MM)	LB/FT (KG/M)
98-110	0.020 (0.508)	10 (15)	0.040 (1.016)	23 (34)	0.060 (1.524)	36 (54)	0.080 (2.032)	51 (76)	0.100 (2.540)	65 (97)		
98-111	0.020 (0.508)	0.08 (0.12)	0.045 (1.143)	0.18 (0.27)	0.065 (1.651)	0.26 (0.39)	0.090 (2.286)	0.36 (0.54)	0.110 (2.794)	0.44 (0.65)		
98-112	0.025 (0.635)	0.8 (1.2)	0.050 (1.270)	1.4 (2.1)	0.070 (1.778)	1.9 (2.8)	0.095 (2.413)	2.9 (4.3)	0.120 (3.048)	4.1 (6.1)		
98-113	0.016 (0.406)	0.3 (0.4)	0.032 (0.813)	0.7 (1.0)	0.048 (1.219)	1 (1.5)	0.064 (1.626)	1.4 (2.1)	0.080 (2.032)	2.1 (3.1)		
98-114	0.012 (0.305)	0.3 (0.4)	0.024 (0.610)	0.6 (0.9)	0.036 (0.914)	1 (1.5)	0.048 (1.219)	1.4 (2.1)	0.060 (1.524)	2.1 (3.1)		
98-115	0.120 (3.048)	1.3 (1.9)	0.105 (2.667)	3.2 (4.8)	0.095 (2.413)	4.6 (6.8)	0.0802 (2.03)	5 (7.4)	0.070 (1.778)	9.2 (13.7)		
98-105												
98-116	0.013 (0.330)	10 (14)	0.026 (0.660)	18 (27)	0.039 (0.991)	24 (36)	0.052 (1.321)	34 (50)	0.065 (1.651)	42 (62)		
98-117	0.020 (0.508)	0.5 (0.7)	0.040 (1.016)	1.2 (1.8)	0.055 (1.397)	1.8 (2.7)	0.075 (1.905)	2.6 (3.9)	0.095 (2.413)	3.6 (5.4)		
98-134	0.020 (0.508)	0.5 (0.7)	0.040 (1.016)	1.3 (1.9)	0.060 (1.524)	2.1 (3.1)	0.080 (2.032)	3.4 (5.1)	0.100 (2.540)	7.5 (11.2)		
98-136	0.016 (0.406)	1.2 (1.8)	0.032 (0.813)	2.6 (3.9)	0.048 (1.219)	4.5 (6.7)	0.064 (1.626)	7.2 (10.7)	0.080 (2.032)	12 (17.9)		
98-137	0.030 (0.762)	4 (6)	0.065 (1.651)	9 (13)	0.095 (2.413)	13 (19)	0.130 (3.302)	19 (28)	0.160 (4.064)	26 (39)		
98-139	0.145 (3.683)	0.4 (0.6)	0.130 (3.302)	0.8 (1.2)	0.110 (2.794)	1.3 (1.9)	0.095 (2.413)	1.7 (2.5)	0.080 (2.032)	2.5 (3.7)		
98-210	0.010 (0.254)	0.4 (0.6)	0.020 (0.508)	0.8 (1.2)	0.030 (0.762)	1.2 (1.8)	0.040 (1.016)	1.7 (2.5)	0.050 (1.270)	2.2 (3.3)		
98-211	0.010 (0.254)	0.2 (0.3)	0.020 (0.508)	0.4 (0.6)	0.030 (0.762)	0.6 (0.9)	0.040 (1.016)	0.9 (1.3)	0.050 (1.270)	1.1 (1.6)		
98-223	0.010 (0.254)	0.7 (1)	0.020 (0.508)	1.7 (2.5)	0.030 (0.762)	2.7 (4)	0.040 (1.016)	4.2 (6.2)	0.050 (1.270)	8.8 (13.1)		
98-290	0.030 (0.762)	5 (7)	0.055 (1.397)	10 (14)	0.080 (2.032)	15 (22)	0.110 (2.794)	26 (39)	0.135 (3.429)	36 (54)		
98-300	0.020 (0.508)	0.2 (0.3)	0.040 (1.016)	0.5 (0.7)	0.060 (1.524)	0.9 (1.3)	0.080 (2.032)	1.2 (1.8)	0.100 (2.540)	1.9 (2.8)		
98-410	0.050 (1.270)	4.5 (6.7)	0.100 (2.540)	8.9 (13.2)	0.150 (3.810)	9.8 (14.6)	0.200 (5.080)	12.3 (18.3)	0.250 (6.350)	15.8 (23.5)		
98-430	0.008 (0.203)	0.5 (0.75)	0.016 (0.406)	1.2 (1.8)	0.024 (0.61)	1.9 (2.85)	0.032 (0.813)	2.6 (3.9)	0.04 (1.016)	3.3 (4.95)		

ULTRASOFT GASKETS (continued)

PART NO.	LARGEST OPENING		HEIGHT		DESIGN HEIGHT		HEIGHT		SMALLEST OPENING	
	HEIGHT	LOAD	HEIGHT	LOAD	HEIGHT	LOAD	HEIGHT	LOAD	HEIGHT	LOAD
	INCHES (MM)	LB/FT (KG/M)	INCHES (MM)	LB/FT (KG/M)	INCHES (MM)	LB/FT (KG/M)	INCHES (MM)	LB/FT (KG/M)	INCHES (MM)	LB/FT (KG/M)
98-135	0.120 (3.048)	17 (25)	0.110 (2.794)	39 (58)	0.105 (2.667)	58 (86)	0.095 (2.413)	103 (153)	0.085 (2.159)	165 (246)
98-221	0.064 (1.626)	1.9 (2.8)	0.058 (1.473)	3.9 (5.8)	0.052 (1.321)	6.4 (9.5)	0.046 (1.168)	9.2 (13.7)	0.040 (1.016)	17.5 (26)
98-251	0.084 (2.134)	0.9 (1.3)	0.078 (1.981)	2.4 (3.6)	0.072 (1.829)	3.4 (5.1)	0.066 (1.676)	4.5 (6.7)	0.060 (1.524)	6.8 (10.1)
98-310	0.250 (6.350)	1.2 (1.8)	0.225 (5.715)	2 (3)	0.195 (4.953)	3.2 (4.8)	0.170 (4.318)	4.6 (6.8)	0.140 (3.556)	11.8 (17.6)
98-320	0.016 (0.406)	7 (10)	0.032 (0.813)	16 (24)	0.048 (1.219)	28 (42)	0.064 (1.626)	42 (62)	0.080 (2.032)	58 (86)
98-340	0.165 (4.191)	1 (1)	0.150 (3.810)	4 (6)	0.140 (3.556)	6 (9)	0.125 (3.175)	16 (24)	0.110 (2.794)	43 (64)
98-360	0.100 (2.540)	0.6 (0.9)	0.090 (2.286)	1.5 (2.2)	0.080 (2.032)	2.5 (3.7)	0.070 (1.778)	4 (6)	0.060 (1.524)	18.3 (27.2)
98-370	0.027 (0.686)	8 (12)	0.024 (0.610)	17 (25)	0.021 (0.533)	28 (41)	0.018 (0.457)	34 (50)	0.015 (0.381)	38 (57)
98-380	0.082 (2.083)	1 (1)	0.074 (1.880)	2 (3)	0.066 (1.676)	6 (6)	0.058 (1.473)	14 (21)	0.050 (1.270)	39 (58)
98-390	0.185 (4.699)	5 (7)	0.170 (4.318)	10 (15)	0.150 (3.810)	21 (31)	0.135 (3.429)	31 (45)	0.120 (3.048)	44 (65)
98-435	0.210 (5.334)	0.1 (0.2)	0.170 (4.318)	0.3 (0.4)	0.130 (3.302)	0.6 (0.9)	0.090 (2.286)	0.6 (0.9)	0.050 (1.270)	0.8 (1.2)
98-436	0.210 (5.334)	0.9 (1.3)	0.170 (4.318)	1.8 (2.7)	0.130 (3.302)	2.7 (4)	0.090 (2.286)	3.6 (5.4)	0.050 (1.270)	5.9 (8.8)
98-438	0.210 (5.334)	3.2 (4.8)	0.175 (4.445)	6.4 (9.5)	0.135 (3.429)	9.4 (14)	0.100 (2.540)	12.4 (18.5)	0.060 (1.524)	17.8 (26.5)
98-440	0.340 (8.636)	5 (7.4)	0.280 (7.112)	7.3 (10.9)	0.210 (5.334)	9.7 (14.4)	0.150 (3.810)	12.2 (18.2)	0.080 (2.032)	16.3 (24.3)
98-500	0.195 (4.953)	3.8 (5.7)	0.160 (4.064)	5.8 (8.6)	0.130 (3.302)	7.1 (10.6)	0.095 (2.413)	8.4 (12.5)	0.060 (1.524)	10.2 (15.2)
98-505	0.195 (4.953)	4 (6.0)	0.160 (4.064)	6.3 (9.4)	0.130 (3.302)	7.7 (11.5)	0.095 (2.413)	9.4 (14)	0.060 (1.524)	12.5 (18.6)
98-510	0.200 (5.080)	3.8 (5.7)	0.175 (4.445)	5.9 (8.85)	0.145 (3.683)	11.6 (17.4)	0.120 (3.048)	24.8 (37.2)	0.090 (2.286)	55.7 (83.6)
98-515	0.195 (4.953)	2.8 (4.2)	0.160 (4.064)	4.7 (7)	0.130 (3.302)	5.8 (8.6)	0.095 (2.413)	7.3 (10.9)	0.060 (1.524)	11 (16.4)
98-520	0.120 (3.048)	8 (11)	0.100 (2.540)	12 (18)	0.080 (2.032)	16 (23)	0.060 (1.524)	19 (28)	0.040 (1.016)	23 (34)
98-521	0.125 (3.175)	6 (8)	0.110 (2.794)	15 (22)	0.090 (2.286)	25 (37)	0.075 (1.905)	28 (41)	0.060 (1.524)	32 (47)
98-525	0.120 (3.048)	9 (13)	0.105 (2.667)	16 (24)	0.085 (2.159)	22 (33)	0.070 (1.778)	26 (39)	0.050 (1.270)	32 (47)
98-535	0.210 (5.334)	9 (13.4)	0.175 (4.445)	15 (22.3)	0.135 (3.429)	23 (34.2)	0.100 (2.540)	31.5 (46.9)	0.060 (1.524)	53 (78.9)
98-536	0.265 (6.731)	2.2 (3.3)	0.220 (5.588)	3.6 (5.4)	0.170 (4.318)	4.6 (6.8)	0.125 (3.175)	5.2 (7.7)	0.080 (2.032)	6.6 (9.8)
98-537	0.350 (8.890)	6 (8.9)	0.285 (7.239)	10 (14.9)	0.225 (5.715)	12.8 (19)	0.160 (4.064)	15.7 (23.4)	0.100 (2.540)	19 (28.3)
98-538	0.210 (5.334)	9 (13.4)	0.175 (4.445)	15 (22.3)	0.135 (3.429)	23 (34.2)	0.100 (2.540)	31.5 (46.9)	0.060 (1.524)	53 (78.9)
98-540	0.096 (2.438)	12 (18)	0.082 (2.083)	22 (33)	0.068 (1.727)	30 (45)	0.054 (1.372)	38 (57)	0.040 (1.016)	43 (63)
98-541	0.106 (2.692)	9 (13)	0.092 (2.337)	17 (25)	0.078 (1.981)	25 (37)	0.064 (1.626)	35 (51)	0.050 (1.270)	44 (65)
98-542	0.074 (1.880)	11 (16)	0.068 (1.727)	22 (33)	0.062 (1.575)	32 (48)	0.056 (1.422)	42 (62)	0.050 (1.270)	50 (74)
98-544	0.096 (2.438)	5 (7)	0.082 (2.083)	9 (13)	0.068 (1.727)	13 (19)	0.054 (1.372)	19 (28)	0.040 (1.016)	25 (37)
98-545	0.350 (8.890)	6 (8.9)	0.285 (7.239)	10 (14.9)	0.225 (5.715)	12.8 (19)	0.160 (4.064)	15.7 (23.4)	0.100 (2.540)	19 (28.3)
98-548	0.220 (5.588)	2.6 (3.9)	0.190 (4.826)	3.7 (5.5)	0.160 (4.064)	5.0 (7.5)	0.130 (3.300)	13.8 (20.7)	0.100 (2.540)	19.0 (28.5)

All dimensions shown are in inches (millimeters) unless otherwise specified.



ULTRASOFT GASKETS (continued)

PART NO.	LARGEST OPENING		DESIGN HEIGHT				SMALLEST OPENING			
	HEIGHT	LOAD	HEIGHT	LOAD	HEIGHT	LOAD	HEIGHT	LOAD		
	INCHES (MM)	LB/FT (KG/M)	INCHES (MM)	LB/FT (KG/M)	INCHES (MM)	LB/FT (KG/M)	INCHES (MM)	LB/FT (KG/M)		
98-550	0.026 (0.660)	2.3 (3.4)	0.022 (0.559)	6.5 (9.7)	0.018 (0.457)	9 (13.4)	0.014 (0.356)	12 (17.9)	0.010 (0.254)	15.4 (22.9)
98-450	0.026 (0.660)	2.3 (3.45)	0.022 (0.559)	6.5 (99.75)	0.018 (0.457)	9 (913.5)	0.014 (0.356)	12 (18)	0.010 (0.254)	15.4 (23.1)
98-551	0.026 (0.660)	3.6 (5.4)	0.022 (0.559)	7.8 (11.6)	0.018 (0.457)	12.4 (18.5)	0.014 (0.356)	15.4 (22.9)	0.010 (0.254)	18.1 (26.9)
98-552	0.026 (0.660)	1 (1.5)	0.022 (0.559)	2.9 (4.3)	0.018 (0.457)	7.4 (11)	0.014 (0.356)	15.5 (23.1)	0.010 (0.254)	28.2 (42)
98-553	0.026 (0.660)	1 (1.5)	0.022 (0.559)	2.9 (4.3)	0.018 (0.457)	7.4 (11)	0.014 (0.356)	15.5 (23.1)	0.010 (0.254)	28.2 (42)
98-555	0.063 (1.600)	4 (6)	0.056 (1.422)	7.5 (11.2)	0.049 (1.245)	11.5 (17.1)	0.042 (1.067)	14 (20.8)	0.035 (0.889)	16 (23.8)
98-558	0.060 (1.524)	3.1 (4.6)	0.050 (1.270)	5.4 (8)	0.040 (1.016)	7.2 (10.7)	0.030 (0.762)	8.6 (12.8)	0.020 (0.508)	10.9 (16.2)
98-559	0.063 (1.600)	3.9 (5.8)	0.056 (1.422)	7.4 (11)	0.049 (1.245)	9.8 (14.6)	0.042 (1.067)	12.2 (18.2)	0.035 (0.889)	13.3 (19.8)
98-560	0.063 (1.600)	6 (8)	0.056 (1.422)	12 (18)	0.049 (1.245)	18 (27)	0.042 (1.067)	24 (35)	0.035 (0.889)	27 (41)
98-563	0.026 (0.660)	3.3 (4.9)	0.022 (0.559)	6.5 (9.7)	0.018 (0.457)	10.6 (15.8)	0.014 (0.356)	13.1 (19.5)	0.010 (0.254)	16.5 (24.6)
98-564	0.026 (0.660)	3.3 (4.9)	0.022 (0.559)	6.5 (9.7)	0.018 (0.457)	10.6 (15.8)	0.014 (0.356)	13.1 (19.5)	0.010 (0.254)	16.5 (24.6)
98-572	0.068 (1.727)	5 (7.4)	0.061 (1.549)	9.6 (14.3)	0.054 (1.372)	13 (19.3)	0.047 (1.194)	15.3 (22.8)	0.040 (1.016)	16.2 (24.1)
98-580	0.068 (1.727)	5 (7.4)	0.061 (1.549)	9.6 (14.3)	0.054 (1.372)	13 (19.3)	0.047 (1.194)	15.3 (22.8)	0.040 (1.016)	16.2 (24.1)
98-574	0.068 (1.727)	5 (7.4)	0.061 (1.549)	9.6 (14.3)	0.054 (1.372)	13 (19.3)	0.047 (1.194)	15.3 (22.8)	0.040 (1.016)	16.2 (24.1)
98-575	0.063 (1.600)	14.6 (21.9)	0.056 (1.422)	22.5 (33.5)	0.049 (1.244)	28.7 (42.8)	0.042 (1.067)	37.0 (55.5)	0.035 (0.889)	50.5 (75.1)
98-576	0.066 (1.676)	5.7 (8.5)	0.057 (1.448)	10 (14.9)	0.048 (1.219)	13.6 (20.2)	0.039 (0.991)	15.1 (22.5)	0.030 (0.762)	15.8 (23.5)
98-584	0.066 (1.676)	5.7 (8.5)	0.057 (1.448)	10 (14.9)	0.048 (1.219)	13.6 (20.2)	0.039 (0.991)	15.1 (22.5)	0.030 (0.762)	15.8 (23.5)
98-578	0.066 (1.676)	5.7 (8.5)	0.057 (1.448)	10 (14.9)	0.048 (1.219)	13.6 (20.2)	0.039 (0.991)	15.1 (22.5)	0.030 (0.762)	15.8 (23.5)
98-603	0.170 (4.318)	1.2 (1.8)	0.145 (3.683)	2.2 (3.3)	0.115 (2.921)	3.6 (5.4)	0.090 (2.286)	5 (7.4)	0.060 (1.524)	12 (17.9)
98-604	0.240 (6.096)	1.6 (2.4)	0.200 (5.080)	3.3 (4.9)	0.160 (4.064)	5 (7.4)	0.120 (3.048)	7.4 (11)	0.080 (2.032)	13.3 (19.8)
98-605	0.170 (4.318)	1.2 (1.8)	0.145 (3.683)	2.2 (3.3)	0.115 (2.921)	3.6 (5.4)	0.090 (2.286)	5 (7.4)	0.060 (1.524)	12 (17.9)
98-606	0.170 (4.318)	1 (1.5)	0.145 (3.683)	1.8 (2.7)	0.115 (2.921)	2.9 (4.3)	0.090 (2.286)	4.1 (6.1)	0.060 (1.524)	10.3 (15.3)
98-607	0.240 (6.096)	1.6 (2.4)	0.200 (5.080)	3.3 (4.9)	0.160 (4.064)	5 (7.4)	0.120 (3.048)	7.4 (11)	0.080 (2.032)	13.3 (19.8)
98-610	0.089 (2.261)	3 (4)	0.078 (1.981)	15 (22)	0.067 (1.702)	30 (45)	0.056 (1.422)	42 (62)	0.045 (1.143)	53 (78)
98-611	0.090 (2.286)	2 (3)	0.080 (2.032)	5 (7)	0.070 (1.778)	7 (10)	0.060 (1.524)	23 (34)	0.050 (1.270)	50 (74)
98-612	0.088 (2.235)	2 (3)	0.076 (1.930)	4 (5)	0.064 (1.626)	9 (13)	0.052 (1.321)	30 (44)	0.040 (1.016)	41 (60)
98-613	0.088 (2.235)	9 (13)	0.076 (1.930)	16 (24)	0.064 (1.626)	23 (34)	0.052 (1.321)	27 (40)	0.040 (1.016)	33 (48)
98-614	0.089 (2.261)	3 (4)	0.078 (1.981)	15 (22)	0.067 (1.702)	30 (45)	0.056 (1.422)	42 (62)	0.045 (1.143)	53 (78)

ULTRASOFT GASKETS (continued)

PART NO.	LARGEST OPENING		DESIGN HEIGHT				SMALLEST OPENING			
	HEIGHT	LOAD	HEIGHT	LOAD	HEIGHT	LOAD	HEIGHT	LOAD		
	INCHES (MM)	LB/FT (KG/M)	INCHES (MM)	LB/FT (KG/M)	INCHES (MM)	LB/FT (KG/M)	INCHES (MM)	LB/FT (KG/M)		
98-619	0.070 (1.778)	9 (13)	0.060 (1.524)	20 (30)	0.045 (1.143)	41 (61)	0.035 (0.889)	57 (85)	0.025 (0.635)	77 (115)
98-620	0.070 (1.778)	9 (13)	0.060 (1.524)	20 (30)	0.045 (1.143)	41 (61)	0.035 (0.889)	57 (85)	0.025 (0.635)	77 (115)
98-621	0.104 (2.642)	2 (3)	0.088 (2.235)	4 (6)	0.072 (1.829)	15 (22)	0.056 (1.422)	29 (43)	0.040 (1.016)	42 (62)
98-622	0.110 (2.794)	0.8 (1.2)	0.095 (2.413)	2.6 (3.9)	0.085 (2.159)	3.8 (5.7)	0.070 (1.778)	16 (23.8)	0.060 (1.524)	27 (40.2)
98-625	0.165 (4.191)	2.4 (3.6)	0.140 (3.556)	4.6 (6.8)	0.110 (2.794)	7.6 (11.3)	0.085 (2.159)	11.5 (17.1)	0.060 (1.524)	15.1 (22.5)
98-628	0.180 (4.572)	0.4 (0.6)	0.155 (3.937)	1 (1.5)	0.125 (3.175)	1.8 (2.7)	0.100 (2.540)	2.6 (3.9)	0.070 (1.778)	5.8 (8.6)
98-629	0.180 (4.572)	0.4 (0.6)	0.155 (3.937)	1 (1.5)	0.125 (3.175)	1.8 (2.7)	0.100 (2.540)	2.6 (3.9)	0.070 (1.778)	5.8 (8.6)
98-630	0.180 (4.572)	0.4 (0.6)	0.155 (3.937)	1 (1.5)	0.125 (3.175)	1.8 (2.7)	0.100 (2.540)	2.6 (3.9)	0.070 (1.778)	5.8 (8.6)
98-631	0.185 (4.699)	0.6 (0.9)	0.160 (4.064)	1.2 (1.8)	0.130 (3.302)	2.1 (3.1)	0.105 (2.667)	2.8 (4.2)	0.080 (2.032)	6.4 (9.5)
98-632	0.185 (4.699)	0.5 (0.7)	0.160 (4.064)	1 (1.5)	0.130 (3.302)	1.6 (2.4)	0.105 (2.667)	2.2 (3.3)	0.080 (2.032)	7 (10.4)
98-633	0.185 (4.699)	0.6 (0.9)	0.160 (4.064)	1.2 (1.8)	0.130 (3.302)	2.1 (3.1)	0.105 (2.667)	2.8 (4.2)	0.080 (2.032)	6.4 (9.5)
98-634	0.095 (2.413)	6.6 (9.8)	0.086 (2.184)	9.5 (14.2)	0.078 (1.981)	11.1 (16.6)	0.069 (1.753)	13.6 (20.3)	0.060 (1.524)	16.2 (24.2)
98-640	0.210 (5.334)	2.5 (3.7)	0.175 (4.445)	5.1 (7.6)	0.135 (3.429)	7.4 (11)	0.100 (2.540)	9.5 (14.1)	0.060 (1.524)	12.9 (19.2)
98-645	0.026 (0.660)	0.3 (0.4)	0.022 (0.559)	1.1 (1.6)	0.018 (0.457)	3.2 (4.8)	0.014 (0.356)	6 (8)	0.010 (0.254)	9.8 (14.6)
98-650	0.350 (8.890)	2 (3)	0.300 (7.620)	3.4 (5.1)	0.260 (6.604)	4.1 (6.1)	0.210 (5.334)	5.1 (7.6)	0.160 (4.064)	7.2 (10.7)
98-655	0.075 (1.905)	1.5 (2.2)	0.060 (1.524)	5 (7.4)	0.050 (1.270)	7.5 (11.2)	0.035 (0.889)	10 (14.9)	0.020 (0.508)	12 (17.9)
98-656	0.200 (5.080)	0.7 (1)	0.170 (4.318)	1.3 (1.9)	0.140 (3.556)	1.6 (2.4)	0.110 (2.794)	2.1 (3.1)	0.080 (2.032)	3.1 (4.6)
98-912	0.220 (5.588)	2.1 (3.1)	0.185 (4.699)	3.6 (5.4)	0.150 (3.810)	5.1 (7.6)	0.114 (2.896)	6.7 (10)	0.079 (2.007)	8.4 (12.5)
98-951	0.190 (4.826)	6 (8)	0.165 (4.191)	10 (14)	0.135 (3.429)	15 (22)	0.110 (2.794)	24 (36)	0.080 (2.032)	51 (75)
98-952	0.190 (4.826)	5 (7)	0.165 (4.191)	7 (10)	0.135 (3.429)	10 (14)	0.110 (2.794)	14 (21)	0.080 (2.032)	26 (39)
98-954	0.126 (3.200)	5 (7)	0.112 (2.845)	10 (15)	0.098 (2.489)	15 (22)	0.084 (2.133)	22 (32)	0.070 (1.778)	35 (52)
98-955	0.126 (3.200)	5 (7)	0.112 (2.845)	10 (14)	0.098 (2.489)	15 (22)	0.084 (2.133)	21 (31)	0.070 (1.778)	32 (48)
98-957	0.100 (2.540)	9 (13)	0.090 (2.286)	18 (27)	0.080 (2.032)	24 (36)	0.070 (1.778)	33 (49)	0.060 (1.524)	53 (79)
98-958	0.101 (2.565)	3.1 (4.6)	0.092 (2.337)	6.8 (10.1)	0.083 (2.108)	10.4 (15.5)	0.074 (1.880)	15.9 (23.7)	0.065 (1.651)	24.2 (36)
98-975	0.255 (6.477)	0.5 (0.7)	0.210 (5.334)	0.8 (1.1)	0.160 (4.064)	1.1 (1.6)	0.115 (2.921)	1.3 (1.9)	0.070 (1.778)	1.7 (2.5)
98-976	0.145 (3.683)	0.3 (0.4)	0.115 (2.921)	0.6 (0.9)	0.080 (2.032)	1 (1.5)	0.050 (1.270)	1.3 (1.9)	0.020 (0.508)	2.8 (4.2)

All dimensions shown are in inches (millimeters) unless otherwise specified.



STRIP METAL GASKETS

The graphs and tables of radiated and transfer impedance measurements in this section compare beryllium copper (-02) with either tin plating (-08) or bright tin plating (-17), in various gasket configurations.

Obtaining the same level of shielding effectiveness shown in the following tested gaskets to MIL-DTL-83528, Para. 4.6.12 or SAE ARP 1705 may not be accomplished without an equivalent test flange/fixture configuration. Many mechanical factors (size, tolerances, cover plate fastening/holding, flange stiffness, etc.) influence performance by enhancing or lowering shielding effectiveness.

The data presented provides a valuable electrical design tool for gasket material comparison/selection. Radiated shielding effectiveness values can

be approximately 38 dB higher than transfer impedance shielding effectiveness values. This is because the measurement is influenced by the characteristic impedance of the transmission line fixture with respect to the localized ground reference. The specified MIL-DTL-83528 radiated fixture aperture is 24.000 in. x 24.000 in. (609.600 mm x 609.600 mm), This aperture size results in attenuation, along with reflections and resonances, which creates a test anomaly at 200 MHz, thus limiting the measurable shielding effectiveness. The specimen configuration as specified in MIL-DTL-83528 is a 1.000 in. (25.400 mm) wide flat strip; in contrast, the data presented in this section is based on a wide range of specimen configurations for practical shielding design applications.

Note: For all gaskets, shielding effectiveness measurements were taken at recommended compression.

ALL-PURPOSE GASKET PART NO. 0097-0500-XX

TABLE 1. MIL-DTL-83528* RADIATED SHIELDING EFFECTIVENESS (dB)

	FREQUENCY	-02 (CU)	-08 (SN)
MAGNETIC	9 kHz	5	5
	100 kHz	44	45
	**1 MHz	83	85
PLANE WAVE	**10 MHz	121	125
	200 MHz	113	114
	1 GHz	125	127
	10 GHz	72	73
	18 GHz	65	61

* Fixture design (clamping vs. bolt configuration)
** Projected H-Field data

**RADIATED
PART NO. 0097-0500-XX**



TABLE 2. SAE ARP 1705 TRANSFER IMPEDANCE SHIELDING EFFECTIVENESS (dB)

FREQUENCY	-02 (CU)	-08 (SN)
10 kHz	97	97
100 kHz	122	122
1 MHz	121	126
10 MHz	115	116
100 MHz	105	105
1 GHz	87	90

**TRANSFER IMPEDANCE
PART NO. 0097-0500-XX**



All dimensions shown are in inches (millimeters) unless otherwise specified.



NO SNAG GASKET PART NO. 0077-0014-XX

TABLE 1. MIL-DTL-83528* RADIATED SHIELDING EFFECTIVENESS (dB)

	FREQUENCY	-02 (CU)	-08 (SN)
MAGNETIC	9 kHz	7	7
	100 kHz	46	45
	**1 MHz	85	83
	**10 MHz	123	121
PLANE WAVE	200 MHz	114	114
	1 GHz	128	101
	10 GHz	65	65
	18 GHz	47	44

* Fixture design (clamping vs. bolt configuration)
** Projected H-Field data

RADIATED
PART NO. 0077-0014-XX



TABLE 2. SAE ARP 1705 TRANSFER IMPEDANCE SHIELDING EFFECTIVENESS (dB)

FREQUENCY	-02 (CU)	-08 (SN)
10 kHz	102	101
100 kHz	126	125
1 MHz	130	129
10 MHz	119	118
100 MHz	107	106
1 GHz	94	97

TRANSFER IMPEDANCE
PART NO. 0077-0014-XX



TWIST SERIES PART NO. 0097-0555-XX

TABLE 1. MIL-DTL-83528* RADIATED SHIELDING EFFECTIVENESS (dB)

	FREQUENCY	-02 (CU)	-08 (SN)
MAGNETIC	9 kHz	13	13
	100 kHz	49	49
	**1 MHz	85	85
	**10 MHz	121	121
PLANE WAVE	200 MHz	115	114
	1 GHz	102	101
	10 GHz	48	56
	18 GHz	48	44

* Fixture design (clamping vs. bolt configuration)
** Projected H-Field data

RADIATED
PART NO. 0097-0555-XX



TABLE 2. SAE ARP 1705 TRANSFER IMPEDANCE SHIELDING EFFECTIVENESS (dB)

FREQUENCY	-02 (CU)	-08 (SN)
10 kHz	102	102
100 kHz	124	123
1 MHz	121	120
10 MHz	113	110
100 MHz	96	95
1 GHz	59	61

TRANSFER IMPEDANCE
PART NO. 0097-0555-XX





TWIST SERIES PART NO. 0097-0560-XX

TABLE 1. MIL-DTL-83528* RADIATED SHIELDING EFFECTIVENESS (dB)

	FREQUENCY	-02 (CU)	-08 (SN)
MAGNETIC	9 kHz	13	13
	100 kHz	48	52
	**1 MHz	83	91
PLANE WAVE	**10 MHz	118	130
	200 MHz	115	113
	1 GHz	127	124
	10 GHz	85	66
	18 GHz	80	79

* Fixture design (clamping vs. bolt configuration)
** Projected H-Field data

**RADIATED
PART NO. 0097-0560-XX**



TABLE 2. SAE ARP 1705 TRANSFER IMPEDANCE SHIELDING EFFECTIVENESS (dB)

FREQUENCY	-02 (CU)	-08 (SN)
10 kHz	101	102
100 kHz	124	125
1 MHz	130	129
10 MHz	120	119
100 MHz	110	108
1 GHz	88	87

**TRANSFER IMPEDANCE
PART NO. 0097-0560-XX**

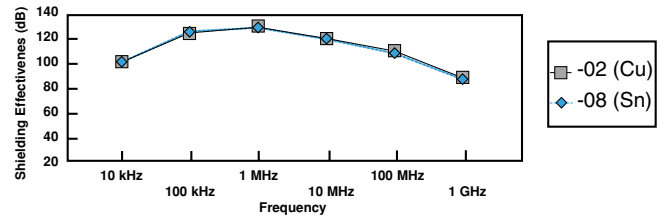

FOLDOVER SERIES PART NO. 0097-0515-XX

TABLE 1. MIL-DTL-83528* RADIATED SHIELDING EFFECTIVENESS (dB)

	FREQUENCY	-02 (CU)	-08 (SN)
MAGNETIC	9 kHz	7	7
	100 kHz	43	46
	**1 MHz	79	84
PLANE WAVE	**10 MHz	114	122
	200 MHz	115	116
	1 GHz	126	126
	10 GHz	84	92
	18 GHz	82	53

* Fixture design (clamping vs. bolt configuration)
** Projected H-Field data

**RADIATED
PART NO. 0097-0515-XX**

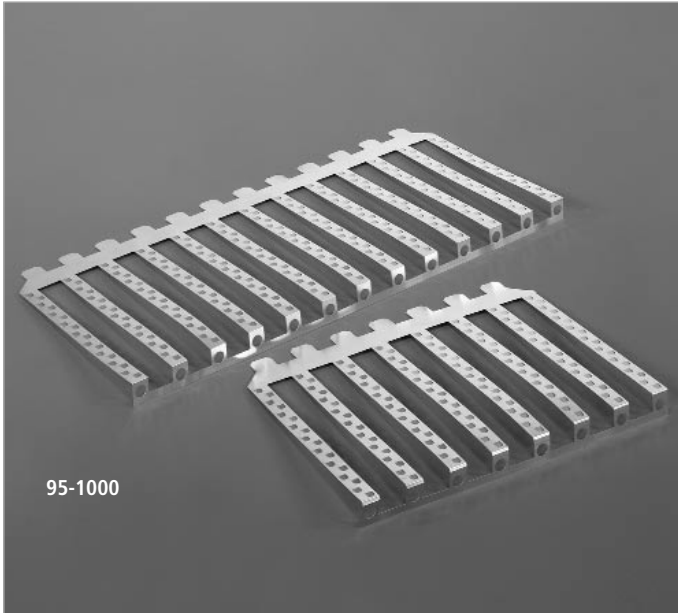

TABLE 2. SAE ARP 1705 TRANSFER IMPEDANCE SHIELDING EFFECTIVENESS (dB)

FREQUENCY	-02 (CU)	-08 (SN)
10 kHz	97	98
100 kHz	122	121
1 MHz	128	131
10 MHz	121	120
100 MHz	111	110
1 GHz	93	93

**TRANSFER IMPEDANCE
PART NO. 0097-0515-XX**





95-1000

Laird Technologies offers its line of card cage shielding, designed to provide EMI/RFI shielding between the chassis and the slot covers.

- Provides a single gasket solution for a multiple of slot covers
- Material thickness of 0.004 in. (0.102 mm) insures low closure force and eliminates possible distortion of mating parts
- 18 contact fingers per rib provides contact points over length of the I/O bracket shield
- Superior contact finger design faces the card cage portion insuring snag-free insertion of add-in cards
- Stainless steel design provides galvanic compatibility to most enclosure materials
- Adaptable tooling allows for 1-21 slot configurations with no tooling cost
- Variable rib widths are available upon request

To discuss your particular application, please contact our sales department.

HOW TO ORDER

All parts start with 009510 as the first six digits. The next two digits designate the number of slots in the part. The last two digits will be 00 for all standard configurations. Example: 0095-1018-00 represents an 18 slot part.

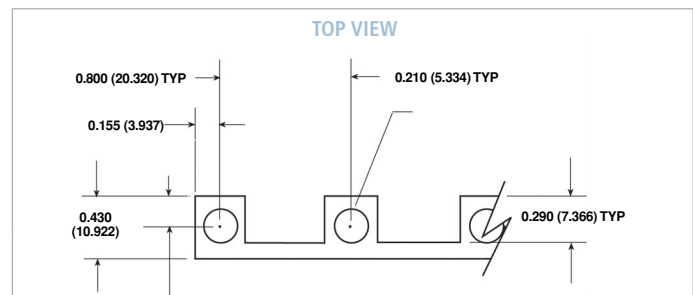
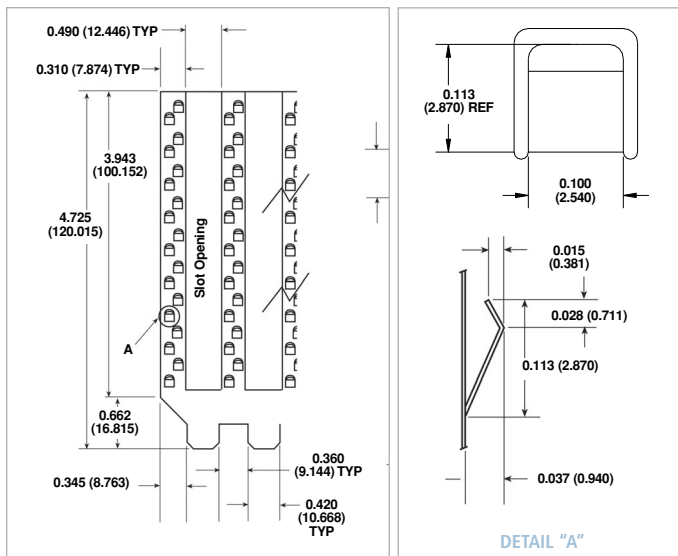

All dimensions shown are in inches (millimeters) unless otherwise specified.



"D" CONNECTOR SHIELDING

Laird Technologies offers the "D" Connector Shield Series for grounding and shielding of D Subminiature Connectors. This series is designed to fit most commonly used 9 pin through 68 pin connectors.

- Available in stainless steel and beryllium copper, conductive elastomers, oriented wire and other materials
- Improved 20 degree angle flange design on metal connectors:
 - provides continuous contact for increased shielding effectiveness
 - fills gaps and adjusts for irregularities in the flatness of the mounting surface
- Beryllium copper parts available in UltraSoft® low force version and available in a wide variety of finishes, see page 1-11
- Custom shapes and designs also available
- Versatile front or rear mounting

SLOTTED "D" CONNECTOR SHIELDING

The slotted D connector gaskets provide shielding for most 9 through 50 pin connectors. The separate finger design provides maximum surface contact, provides high shielding effectiveness and low compression forces.

Slotted D connector gaskets are available from stock in copper beryllium and stainless steel. Copper beryllium parts can be plated to a variety of finishes for galvanic compatibility, see page 1-11.

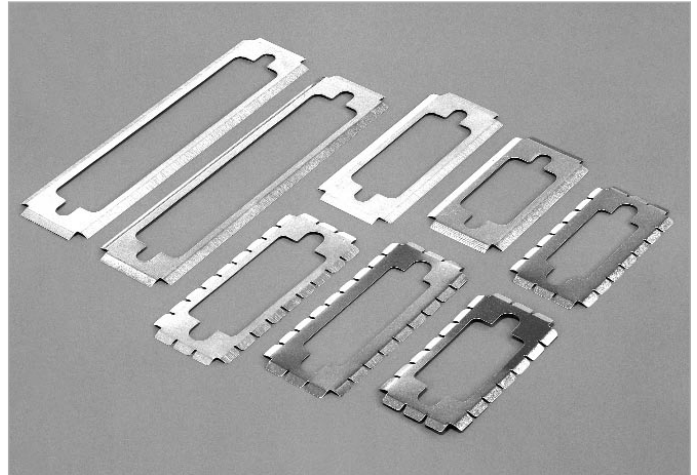

"D" CONNECTOR SERIES DIMENSIONS FOR BeCu AND STAINLESS STEEL

SS	BeCu	# PINS	A	B	C	D	E	F	G
97-768	97-778	9	1.410 (35.814)	0.980 (24.892)	0.780 (19.812)	0.220 (5.588)	0.440 (11.176)	0.690 (17.526)	0.130 (3.302)
97-769	97-779	15	1.740 (44.196)	1.310 (33.274)	1.110 (28.194)	0.220 (5.588)	0.440 (11.176)	0.690 (17.526)	0.130 (3.302)
97-770	97-780	25	2.280 (57.912)	1.850 (46.990)	1.650 (41.910)	0.220 (5.588)	0.440 (11.176)	0.690 (17.526)	0.130 (3.302)
97-771	97-781	37	2.930 (74.422)	2.500 (63.500)	2.290 (58.166)	0.220 (5.588)	0.440 (11.176)	0.690 (17.526)	0.130 (3.302)
97-772	97-782	50	2.840 (72.136)	2.410 (61.214)	2.110 (53.594)	0.280 (7.112)	0.550 (13.970)	0.800 (20.320)	0.240 (6.096)
97-773	97-783	68	1.800 (45.720)	1.480 (37.592)	1.260 (32.004)	0.080 (2.032)	0.160 (4.064)	0.400 (10.160)	0.090 (2.286)

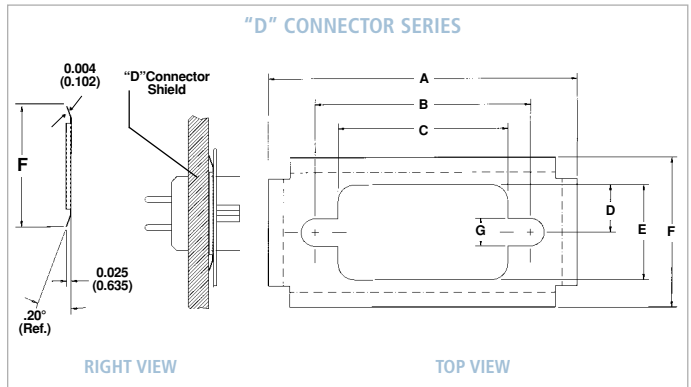

SLOTTED "D" CONNECTOR SHIELDING

SS	BeCu	# Pins	A	B	C	D	E	F	G	Pitch
95-822	97-822	9	1.412 (35.865)	0.984 (24.994)	0.784 (19.914)	0.220 (5.588)	0.440 (11.176)	0.690 (17.526)	0.160 (4.064)	0.718 (18.241)
95-823	97-823	9	1.412 (35.865)	0.984 (24.994)	0.784 (19.914)	0.180 (4.572)	0.360 (9.144)	0.690 (17.526)	0.160 (4.064)	0.178 (4.521)
95-825	97-825	15	1.740 (44.196)	1.312 (33.325)	1.112 (28.245)	0.180 (4.572)	0.360 (9.144)	0.690 (17.526)	0.160 (4.064)	0.175 (4.445)
95-824	97-824	15	1.740 (44.196)	1.312 (33.325)	1.112 (28.245)	0.220 (5.588)	0.360 (9.144)	0.690 (17.526)	0.160 (4.064)	0.175 (4.445)
95-827	97-827	25	2.280 (57.912)	1.852 (47.041)	1.652 (41.960)	0.180 (4.572)	0.360 (9.144)	0.360 (9.144)	0.160 (4.064)	0.174 (4.420)
95-826	97-826	25	2.280 (57.912)	1.852 (47.041)	1.652 (41.960)	0.220 (5.588)	0.440 (11.176)	0.690 (17.526)	0.160 (4.064)	0.174 (4.420)
95-828	97-828	37	2.298 (58.369)	2.500 (63.500)	2.290 (58.166)	0.220 (5.588)	0.440 (11.176)	0.690 (17.526)	0.160 (4.064)	0.184 (4.674)

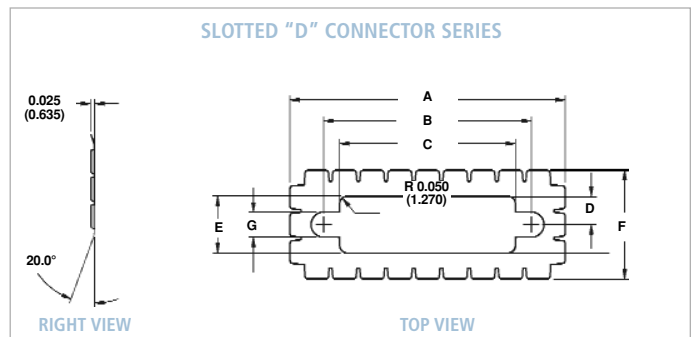

All dimensions shown are in inches (millimeters) unless otherwise specified.

METAL CONNECTOR SHIELDS DIN CONNECTOR SERIES



Laird Technologies' DIN Connector Gasket Series is designed to ground connector plugs to the chassis of electronic systems. Manufactured in beryllium copper, these connector gaskets provide excellent conductivity and shielding characteristics.

- Available in two sizes to accommodate a variety of DIN connector plugs
- Large compression range between board and chassis
- Wide footprint to accommodate misalignment of plug to chassis opening
- Unique slide-on design for ease of assembly
- Grounds circuit boards, as well as keyboards and audio equipment
- Available in a wide variety of plated finishes, see page 1-11



*97-725 is available without the formed bends or with bends of varying sizes to accommodate your requirements for a variety of connector sizes.

METAL CONNECTOR SHIELDS USB CONNECTOR



Laird Technologies offers the USB (Universal Serial Bus) Type B connector gasket. The unique design easily snaps onto the connector prior to placement on the printed circuit board and fits all Series B USB right angle connector brands. Made from high performance beryllium copper, these gaskets provide superior grounding characteristics and enhances the shielding of the connector due to the short electrical path to the ground plane provided when the gasket makes contact with the connector.

- Gasket easily snaps onto the connector for a secure fit
- Connector/gasket assembly can be placed onto the board via pick-and-place
- High clip force attaches clip to connector body for good electrical contact and secure transport prior to soldering
- Once the shielded connector assembly is soldered to the PCB, the shield is captivated between board and connector and provides reliable contact between the connector and faceplate
- Simple compact design fits within 0.625 in. X 0.625 in. (15.875 mm X 15.875 mm) windows
- Available in a variety of plated finishes



All dimensions shown are in inches (millimeters) unless otherwise specified.

METAL CONNECTOR SHIELDS IEEE 1394 HORIZONTAL CONNECTOR GASKET



Laird Technologies offers an addition to our connector gasket line, part number 97-787, which is designed to fit all IEEE 1394 horizontal connectors. Made from copper beryllium, these gaskets provide superior grounding and reduce emissions from the connector by providing a low-impedance grounding path from the connector shell to the faceplate.

The gasket is mounted over the top of a horizontal IEEE 1394 connector and soldered to the board. Contact with both the faceplate and the connector shell is accomplished once the board is assembled into its housing. These gaskets can be provided in trays to facilitate pick-and-place assembly onto the board and wave soldering automation.

- Accommodates a wide range of connector protrusion positions
- Fits all IEEE 1394 horizontal connectors
- Gasket can be placed onto the printed circuit board via pick-and-place
- Packaging to accommodate high-speed assembly is optional
- Simple thru-pin mounting method
- Grounds the connector to the faceplate
- Available in a variety of plating finishes, see page 1-11



All dimensions shown are in inches (millimeters) unless otherwise specified.

METAL CONNECTOR SHIELDS FIBER OPTIC SHIELD



97-727

Laird Technologies provides fiber optic shielding, which provides excellent EMI shielding around the faceplate aperture which houses board mounted fiber optic transceivers. This EMI shield easily fits over the industry standard 1 x 9 style fiber optic transceiver with a duplex SC connector. The shielded transceiver is then inserted into the faceplate.

- Fits all 1 x 9 style fiber optic transceivers with duplex SC connectors
- Provides shielding around the faceplate aperture which houses board-mounted fiber optic transceivers



METAL CONNECTOR SHIELDS GBIC FIBER OPTIC SHIELD

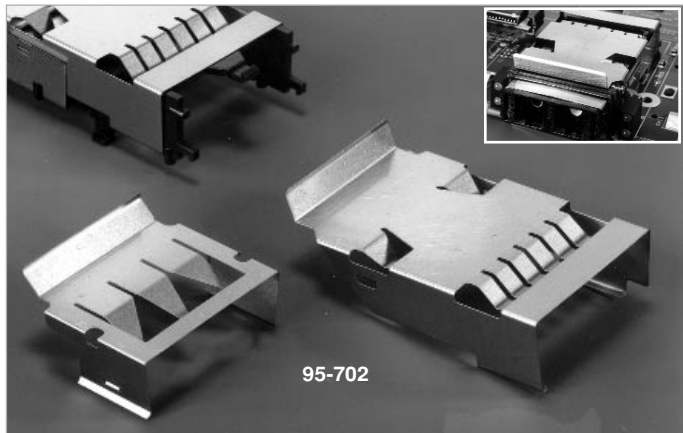

95-702

- Fits most Tyco (AMP) and Methode guide rails common to routers, switches and other network hardware
- Requires no extra mounting holes or solder
- Provided in stainless steel for high galvanic compatibility
- Simple snap-on assembly

HOW TO ORDER:

To obtain the two piece assembly, order part number 95-702.

Laird Technologies offers the GBIC Shield for reducing emissions from GBIC (GigaBit Interface Converter) fiber optic transceivers. Fiber optic transceivers can be a troublesome source of EMI because they emit high-frequency signals and are located adjacent to large apertures in the enclosure. The GBIC Fiber Optic Shield assembly reduces the radiated emissions from the transceivers by conducting interference current away from the transceiver and onto the enclosure surface.

Simple assembly of the shield is accomplished by snapping the two shield halves onto an uninstalled guide rail assembly. The rail is then mounted onto the printed circuit board in the normal fashion.

Spring finger design on both halves of the GBIC shield provide grounding for both sides of a transceiver module. In addition, the bottom half fingers can provide a low impedance connection to the circuit board ground plane.

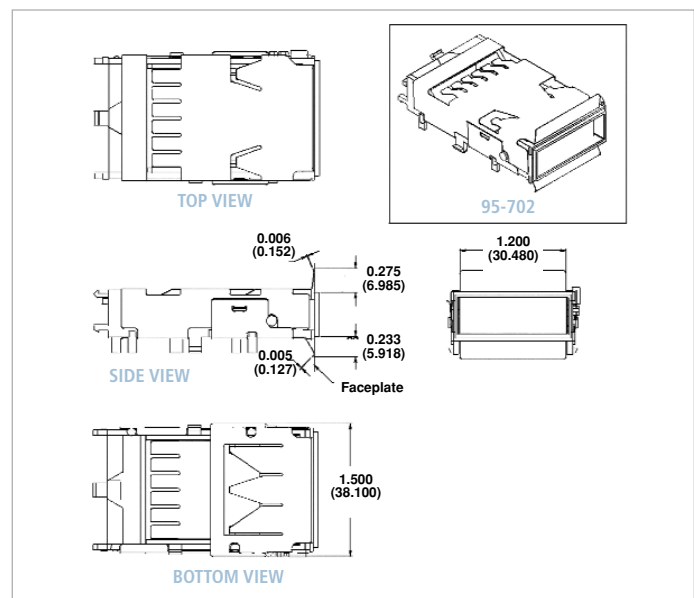

All dimensions shown are in inches (millimeters) unless otherwise specified.



GAIN MAXIMUM ELECTRICAL AND CARRYING PERFORMANCE

From concept to placement, Laird Technologies has the expertise to deliver custom precision surface mount contacts. Using the latest computer simulation techniques, we provide properly designed contacts that ground, carry current and signals, and interconnect boards and devices. We do this by using basic geometric parameters (length, width, uncompressed height, compressed height, contact force) to conduct Finite Element Analysis (FEA) on your prospective design. With the FEA results, we can then identify the best design to optimize your product’s operational performance. We also incorporate features to provide for placement and soldering of the contact onto the circuit board.

Laird Technologies offers a wide range of plating options to allow for maximum electrical current carrying performance. We have exclusive processes such as our innovative Mako process, which selectively plates contacts with precious metals only in the necessary areas. This eliminates bare edges and reduces costs.

Our automated packaging allows for complex and small designs with lower installed costs.

Contact base materials include beryllium copper, phosphor bronze, nickel and stainless steel. All contacts are fully solderable as required.



CUSTOM PRECISION ELECTRONIC CONTACTS MATERIAL VARIATIONS

TYPE	Thickness IN (mm)	Heat Treatment	COATING	Comments
Beryllium-copper alloys: C17200, 190, 174 ASTM	0.0035 to 0.080 (0.089 to 2.032)	Heat treatable in all tempers	Tin, palladium, nickel, gold, silver	Pre-tempered & pre-plated
Nickel-silver alloys: 770, 760, 752 ASTM	0.004 to 0.060 (0.102 to 1.524)	Stress annealed	Varies	Fully solderable (if used with LT proprietary process)
Copper-based alloys: 110, 102, 122, 1093	0.006 to 0.090 (0.152 to 2.286)	N/A	Tin, palladium, nickel, gold, silver	Pre-plated or post-plated
Brass CDA 260 CDA 220	0.006 to 0.090 (0.152 to 2.286)	N/A	Tin, palladium, nickel, gold, silver	Pre-plated or post-plated
Steel High carbon Spring steel	0.008 to 0.080 (0.203 to 2.032)	Austemper	Tin, nickel, black oxide	Post-plated
Stainless steel series: 410, 300, 301, 302	0.004 to 0.012 (0.102 to 0.305)	Heat treatable	Tin Gold	Pre-plated or post-plated
Special alloys, Clad metals, BeCu base or other metal base	0.0031 to 0.080 (0.079 to 2.032)	Heat treatable	Tin, palladium, nickel, gold, palladium/silver	Pre-plated or post-plated
Post-plating	Any thickness required	N/A	Tin, nickel, gold, zinc, silver cadmium, black oxide, black zinc, phosphate	N/A

Additional material choices are available upon request. Material properties are for reference only. Product testing by purchaser is recommended to confirm. Laird Technologies assumes no liability for product failure unless specifically stated in writing.

All dimensions shown are in inches (millimeters) unless otherwise specified.



STANDARD PRECISION ELECTRONIC CONTACTS

Laird Technologies' standard precision electronic contacts ground, carry current and signals, and interconnect boards and devices. We offer a wide choice of plating options to allow for the maximum electrical current carrying performance. We have a wide array of designs in standard format that are ready for production. Installed costs are lowered with our tape and reel packaging format.

STANDARD PRECISION ELECTRONIC CONTACTS MATERIAL VARIATIONS

CONTACTS	MATERIAL	AVAILABLE PLATINGS	TYPICAL APPLICATIONS	PARTS PER REEL
BMIC-001	0.100 mm BeCu	Nickel, tin, gold	Grounding, energy carrying	3000
BMIC-004	0.100 mm BeCu	Nickel, gold	Grounding, energy carrying	1400
BMIC-007-01	0.130 mm BeCu	Copper, tin	Grounding, energy carrying	2300
BMIC-010-*	0.200 mm Spring Steel	Tin	Standoff, support	3500

Material properties are for reference only. Product testing by purchaser is recommended to confirm. Laird Technologies assumes no liability for product failure unless specifically stated in writing.

PART NO. BMIC-001

CONTACTS	MATERIAL	AVAILABLE PLATINGS	TYPICAL APPLICATIONS	PARTS PER REEL
BMIC-001	0.100 mm BeCu	Nickel, tin, gold	Grounding, energy carrying	3000



PART NO. BMIC-007-01

CONTACTS	MATERIAL	AVAILABLE PLATINGS	TYPICAL APPLICATIONS	PARTS PER REEL
BMIC-007-01	0.130 mm BeCu	Copper, tin	Grounding, energy carrying	2300



PART NO. BMIC-004

CONTACTS	MATERIAL	AVAILABLE PLATINGS	TYPICAL APPLICATIONS	PARTS PER REEL
BMIC-004	0.100 mm BeCu	Nickel, gold	Grounding, energy carrying	1400



PART NO. BMIC-010-*

CONTACTS	MATERIAL	AVAILABLE PLATINGS	TYPICAL APPLICATIONS	PARTS PER REEL
BMIC-010-*	0.200 mm Spring Steel	Tin	Standoff, support	3500



All dimensions shown are in inches (millimeters) unless otherwise specified.

GALVANIC CORROSION OF METALS

The galvanic series is a common means of ranking the relative activity of metallic couples. The galvanic series does not provide a measure of the corrosion current which will flow in a dissimilar metal couple, but it does indicate which couples are likely to incur significant corrosion damage. In galvanic couples consisting of two very incompatible metals, it is possible to reduce the corrosion rate through good design practice. In this situation, it is best to maximize the ratio of anode to cathode surface areas. For a particular current density, the corrosion rate on the more anodic metal will be lower the larger this ratio, because the corrosion reaction is spread over a larger surface area. In addition, if corrosion products build up on the cathode, they will build at a faster rate the smaller the surface area of the cathode relative to the anode. In this situation, the deposits could create a barrier that slows down corrosion.

The above technique is used in reverse to enhance the performance of electrical contacts. It is desirable that electrical contacts remain clean to provide a low resistance connection. When corrosion occurs, metal is removed from the more anodic metal. This process cleans the more anodic metal. By making the electrical contact out of one metal and surrounding it by a larger surface area of a more cathodic metal, the contact will be cleaned by the corrosion reaction. The contact may corrode away eventually, but it will function more reliably during its shortened life.

The probability that two dissimilar metals will corrode when coupled together can be predicted from their difference in the electrochemical potentials. This information is tabulated in the Metals Galvanic Compatibility Chart on page 5-2. The common metals and their anodic index are listed along the left side of the chart. The metals are grouped in 0.05 volt increments, with some of the groups containing no common metals. Group Number One (left hand column) contains the most cathodic metals and has an anodic index of zero. The anodic index increases as metals become more anodic. The arrow (on the far right hand side of the chart) points in the direction of increasingly anodic metals. On the right side of the chart, typical finishes available on metallic parts manufactured by Laird Technologies are listed along the top. The colored bars indicate the galvanic compatibility of these common finishes to the metals listed on the left. The color code is based on both the electrochemical differences between the metals and the finishes and the corrosiveness of the environment. The chart shows that the force that drives the corrosion reactions is directly related to the electrochemical difference between any two metals. By reducing this difference, the corrosion rate is decreased.



BASIC CORROSION PREVENTION

Whenever possible, avoid the use of dissimilar metals. The following five steps may be taken to prevent, or at least minimize corrosion potential in the event that it is necessary to use dissimilar metals in intimate contact with one another:

1. Limit contact between metals with widely different electrochemical potentials. The Metals Galvanic Compatibility Chart, on page 5-2, indicates which metal pairs have large differences in electrochemical potential.
2. Insert a third metal between the two dissimilar metals which reduces the potential difference of the galvanic couple. For example, nickel or tin plated copper is suitable for use with aluminum and silver combinations.
3. Design the flange interface so that the surface area of the anodic metal is significantly larger than the cathodic metal. The electromotive force (EMF) difference remains the same. However, the current density is decreased, so the corrosive attack on the cathodic metal is reduced.
4. Eliminate moisture, salts and other electrolytes from entering the joint interface by improved flange design or, if not possible, use an environmental seal outboard of the conductive element in a dual EMI shield/environmental seal.



GROUP NUMBER	COMMON METAL SURFACES METALLURGICAL CATEGORY	ANODIC INDEX, V
1	Gold; Au-Pt alloys; wrought platinum; graphite carbon	0.00
2		0.05
3	Rhodium plating	0.10
4	Silver; high-silver alloys	0.15
5		0.20
6		0.25
7	Nickel; nickel-copper alloys; titanium, titanium alloys; Monel	0.30
8	Beryllium copper; low brasses or bronzes; silver solder; copper; Ni-Cr alloys; austenitic corrosion-resistant steels; most chrome-moly steels; specialty high-temp stainless steels	0.35
9	Commercial yellow brasses and bronzes	0.40
10	High brasses and bronzes; naval brass; Muntz metal	0.45
11	18% Cr type corrosion resistant steels; common 300 series stainless steels	0.50
12		0.55
13	Chromium or tin plating; 12% Cr type corrosion resistant steels; most 400 series stainless steels, i.e., 410 and some cast stainless steels	0.60
14	Terneplate; tin-lead solder	0.65
15	Lead; high-lead alloys	0.70
16	Wrought 2000 series aluminum alloys	0.75
17		0.80
18	Wrought gray or malleable iron; plain carbon and low-alloy steels; armco iron; cold-rolled steel	0.85
19	Wrought aluminum alloys except 2000 series cast Al-Si alloys; 6000 series aluminum	0.90
20	Cast aluminum alloys other than Al-Si; cadmium plating	0.95
21		1.00
22		1.05
23		1.10
24		1.15
25	Hot-dip galvanized or electrogalvanized steel	1.20
26	Wrought zinc; zinc die casting alloys	1.25
27		1.30
28		1.35
29		1.40
30		1.45
31		1.50
32		1.55
33		1.60
34		1.65
35		1.70
36	Wrought and cast magnesium alloys	1.75
37		1.80
38	Beryllium	1.85

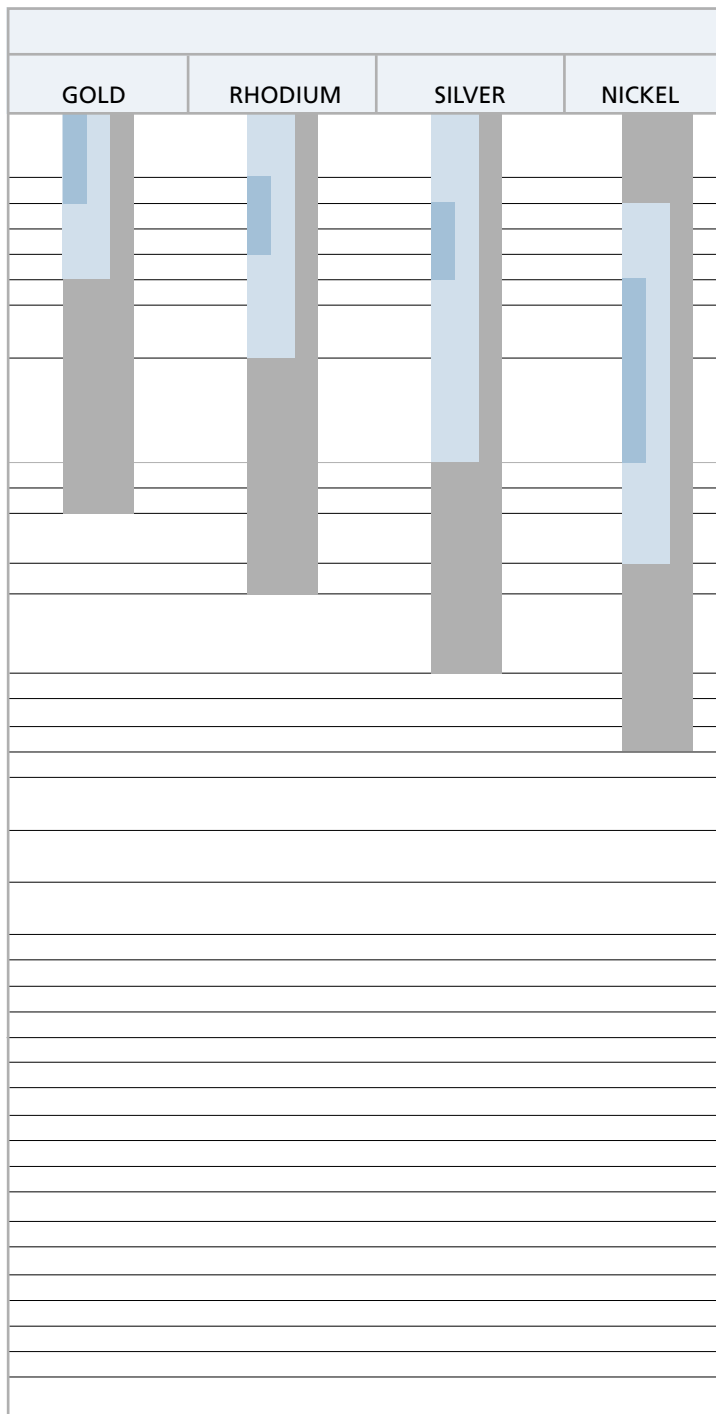

For harsh environments (presence of fair to good ionic conductors), all metals in contact with each other should be no more than one level of the chart apart to minimize corrosion. This is shown by the dark blue regions of the plating bar chart under specific platings. Outdoor applications, high humidity and salt air fall into this category.

For normal environments (storage in warehouses or non-temperature/humidity-controlled environments, etc.), the difference between dissimilar metals should not exceed 0.25 volts (5 chart levels counting the origin). This is shown by the light blue regions of the chart under specific platings.

NORTH AMERICA

Our USA toll-free telephone number is
+1.800.843.4556

Delaware Water Gap, USA

Shielding Way
P.O. Box 650
Delaware Water Gap, PA 18327
Phone +1.570.424.8510
Fax +1.570.424.6213

St. Louis, USA

3481 Rider Trail South
St. Louis, MO 63045
Phone +1.314.344.9300
Fax +1.314.344.9333

San Jose, USA

2030 Fortune Drive
Suite 100
San Jose, CA 95131
Phone +1.408.544.9500
Fax +1.408.577.0691

San Marcos, USA

1825 Diamond Street
San Marcos, CA 92069
Phone +1.760.736.7007
Fax +1.760.736.7008

Schaumburg, USA

1751 Wilkening Court
Schaumburg, IL 60173
Phone +1.847.839.6000
Fax +1.847.519.9682

EUROPE

Germany

Äußere Oberaustraße 22
83026
Rosenheim, Germany
Phone +49.8031.24600
Fax +49.8031.246050

Czech Republic

Prumyslova 497
462 11 Liberec
Czech Republic
Phone +420.48.8575111
Fax +420.48.8575301

France

13-15 rue des Entrepreneurs
91560 Crosne, France
Phone +33.1.69497979
Fax +33.1.69497980

United Kingdom

Warner Drive
Springwood Industrial Estate
Braintree
Essex CM7 2YW
Phone +44.1376.342626
Fax +44.1376.346442

ASIA

Taiwan

4F, No. 6
Hou-Sheng Road
Luchu, Taoyuan, Taiwan 338
Phone +886.33.129292
Fax +886.33.129090

Tokyo, Japan

Shin Yokohama Business Center Building 7F
2-6, Shin Yokohama 3-chome, Kohoku-ku
Yokohama-shi, Kanagawa 222-0033, Japan
Phone +81.45.4736808
Fax +81.45.4736162

Yokohama, Japan

2-12-8 Sachiura, Kanazawa-ku
Yokohama-shi, 236-0003, Japan
Phone +81.45.7851063
Fax +81.45.7851064

Shanghai, China

Building 1, Number 58
Hua Ning Road, Lane 4018
Shanghai, P.R. China 201108
Phone +86.21.6442.8018
Fax +86.21.6489.6055

Shenzhen, China

No. 2 Building, 2nd Industry Park
Tangxiayong Songgang Town
Baoan District, Shenzhen City
Guangdong Province
China 518105
Phone +86.755.2714.1166
Fax +86.755.2714.1199

Suzhou, China

No. 228 Tongyuan Road
Suzhou Industry Park
Suzhou, P.R.China 215006
Phone +86.512.6252.6590
Fax +86.512.6252.7226

Tianjin, China

Building B, Fenghua Industrial Park
66 on the Ninth Avenue, TEDA
Tianjin, P.R. China 300457
Phone +86.22.6629.8160
Fax +86.22.6629.8158

Singapore

750E Chai Chee Road #03-07/08
Technopark@Chai Chee
Singapore 469005
Phone +65.624.38022
Fax +65.624.38021

Korea

2nd Floor, Hwasung Building
34-2 Chunho-dong
Kangdong-ku, Seoul, Korea
Phone +82.2.4771390
Fax +82.2.4771393

NOTICE: Although the information and recommendations set forth herein (hereinafter "information") are presented in good faith and believed to be correct as of the date hereof, Laird Technologies makes no representation or warranties as to the completeness or accuracy thereof. Information is supplied upon the condition that the persons receiving same will make their own determination as to its suitability for their purposes prior to use. In no event will Laird Technologies be responsible for damages of any nature whatsoever resulting from the use or reliance upon information or the product to which information refers. Nothing contained herein is to be construed as a recommendation to use any product, process, equipment or formulation in conflict with any patent, and Laird Technologies makes no representation or warranty, expressed or implied, that the use thereof will not infringe any patent. The data set forth in all tables, charts, graphs and figures herein are based on samples tested and are not guaranteed for all samples or applications. Such data are intended as guides and do not reflect product specifications for any particular product. NO REPRESENTATION OR WARRANTIES, EITHER EXPRESSED OR IMPLIED, OR MERCHANTABILITY, FITNESS FOR A PARTICULAR PURPOSE OR OF ANY OTHER NATURE ARE MADE HEREUNDER WITH RESPECT TO INFORMATION OR THE PRODUCT TO WHICH INFORMATION REFERS.

Ultrasoft®, Sticky Fingers®, Magnefil®, ElectroNit®, Contips®, Snap-Tite® and Grip-Tite® are registered trademarks of Laird Technologies.
Poron® is a registered trademark of Rogers Corporation.



1.800.843.4556 | www.lairdtech.com | NORTH AMERICA | EUROPE | ASIA



Board Level Shields



Fingerstock



Fabric-Over-Foam



Form-In-Place



Conductive Elastomers



Microwave Absorbers



Wire Mesh

Компания «Океан Электроники» предлагает заключение долгосрочных отношений при поставках импортных электронных компонентов на взаимовыгодных условиях!

Наши преимущества:

- Поставка оригинальных импортных электронных компонентов напрямую с производств Америки, Европы и Азии, а так же с крупнейших складов мира;
- Широкая линейка поставок активных и пассивных импортных электронных компонентов (более 30 млн. наименований);
- Поставка сложных, дефицитных, либо снятых с производства позиций;
- Оперативные сроки поставки под заказ (от 5 рабочих дней);
- Экспресс доставка в любую точку России;
- Помощь Конструкторского Отдела и консультации квалифицированных инженеров;
- Техническая поддержка проекта, помощь в подборе аналогов, поставка прототипов;
- Поставка электронных компонентов под контролем ВП;
- Система менеджмента качества сертифицирована по Международному стандарту ISO 9001;
- При необходимости вся продукция военного и аэрокосмического назначения проходит испытания и сертификацию в лаборатории (по согласованию с заказчиком);
- Поставка специализированных компонентов военного и аэрокосмического уровня качества (Xilinx, Altera, Analog Devices, Intersil, Interpoint, Microsemi, Actel, Aeroflex, Peregrine, VPT, Syfer, Eurofarad, Texas Instruments, MS Kennedy, Miteq, Cobham, E2V, MA-COM, Hittite, Mini-Circuits, General Dynamics и др.);

Компания «Океан Электроники» является официальным дистрибьютором и эксклюзивным представителем в России одного из крупнейших производителей разъемов военного и аэрокосмического назначения «**JONHON**», а так же официальным дистрибьютором и эксклюзивным представителем в России производителя высокотехнологичных и надежных решений для передачи СВЧ сигналов «**FORSTAR**».



JONHON

«**JONHON**» (основан в 1970 г.)

Разъемы специального, военного и аэрокосмического назначения:

(Применяются в военной, авиационной, аэрокосмической, морской, железнодорожной, горно- и нефтедобывающей отраслях промышленности)

«**FORSTAR**» (основан в 1998 г.)

ВЧ соединители, коаксиальные кабели, кабельные сборки и микроволновые компоненты:

(Применяются в телекоммуникациях гражданского и специального назначения, в средствах связи, РЛС, а так же военной, авиационной и аэрокосмической отраслях промышленности).



Телефон: 8 (812) 309-75-97 (многоканальный)

Факс: 8 (812) 320-03-32

Электронная почта: ocean@oceanchips.ru

Web: <http://oceanchips.ru/>

Адрес: 198099, г. Санкт-Петербург, ул. Калинина, д. 2, корп. 4, лит. А