

### Typical Applications

The HMC770LP4BE is ideal for:

- Cellular / PCS / 3G
- Fixed Wireless & WLAN
- CATV, Cable Modem & DBS
- Microwave Radio & Test Equipment
- IF & RF Applications

### Features

- High Output IP3: +40 dBm
- Single Positive Supply: +5V
- Low Noise Figure: 2.5 dB <sup>[1]</sup>
- Differential RF I/O's
- 20 Lead 4x4 mm SMT Package: 16mm<sup>2</sup>

### Functional Diagram

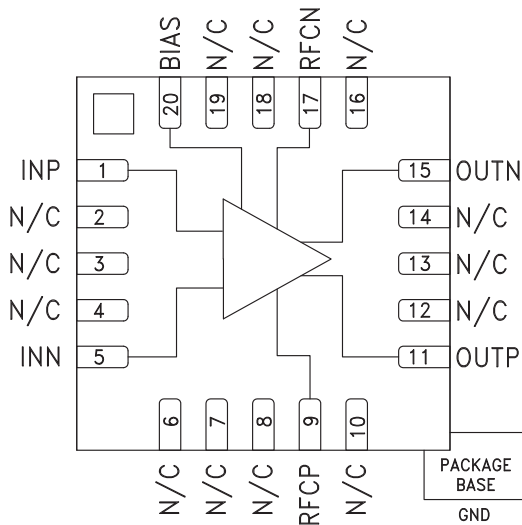

### General Description

The HMC770LP4BE is a GaAs pHEMT Differential Gain Block MMIC amplifier covering 40 MHz to 1 GHz and packaged in a 4x4 mm plastic QFN SMT package. This versatile amplifier can be used as a cascadable IF or RF gain stage in both 50 Ohm and 75 Ohm applications. The HMC770LP4BE delivers 16 dB gain, and +40 dBm output, with only 2.5 dB noise figure. Differential I/Os make this amplifier ideal for transimpedance and SAW filter applications, and in transceivers where the IF path must be handled differentially for improved noise performance. Evaluation PCBs are all available with either SMA (50Ω) or Type F (75Ω) connectors.

### Electrical Specifications, $T_A = +25^\circ\text{C}$ , $V_{dd} = V_{dd1} = V_{dd2} = +5\text{V}$ , $R_{bias} = R1 = 200\ \Omega$ <sup>[2]</sup>

| Parameter  | Min.         | Typ.  | Max. | Min.         | Typ.  | Max. | Units    |
|--|--------------|-------|------|--------------|-------|------|----------|
|  | Zo = 50 Ohms |       |      | Zo = 75 Ohms |       |      |          |
| Frequency Range  | 0.04 - 1     |       |      | 0.04 - 1     |       |      | GHz      |
| Gain <sup>[2]</sup>  | 12           | 16.5  |      | 12           | 16    |      | dB       |
| Gain Variation Over Temperature  |              | 0.006 |      |              | 0.008 |      | dB / °C  |
| Input Return Loss  |              | 17    |      |              | 15    |      | dB       |
| Output Return Loss   |              | 18    |      |              | 15    |      | dB       |
| Output Power for 1 dB Compression (P1dB)                                     | 20           | 23    |      | 21           | 23.5  |      | dBm      |
| Output Third Order Intercept (IP3)<br>(Pout = 0 dBm per tone, 1 MHz spacing) |              | 40    |      |              | 37.5  |      | dBm      |
| Noise Figure <sup>[2]</sup>  |              | 2.5   | 4    |              | 2.75  | 4    | dB       |
| Transimpedance   |              | -     |      |              | 700   |      | Ohms     |
| Input Referred Current Noise <sup>[3]</sup>                                  |              | -     |      |              | 6     |      | pA / √Hz |
| Supply Current 1 (Idd1)  |              | 136   | 160  |              | 136   | 160  | mA       |
| Supply Current 2 (Idd2)  |              | 134   | 160  |              | 134   | 160  | mA       |

[1] 1:1 Balun losses have NOT been removed from measurements. See list of materials for eval PCB for the type of balun.

[2] See application circuit

[3] Includes balun loss, no photo diode. See list of materials for eval PCB for the type of balun.

**Gain & Return Loss [1]**

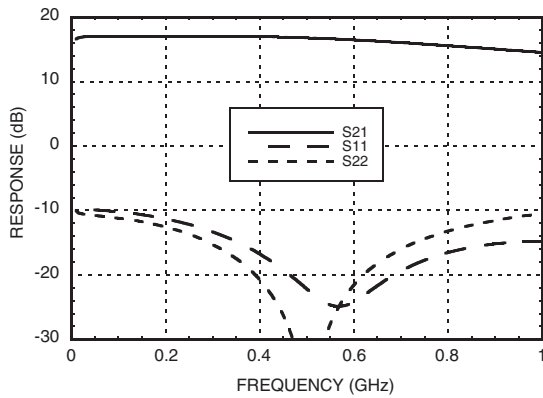

**Gain vs. Temperature [1]**

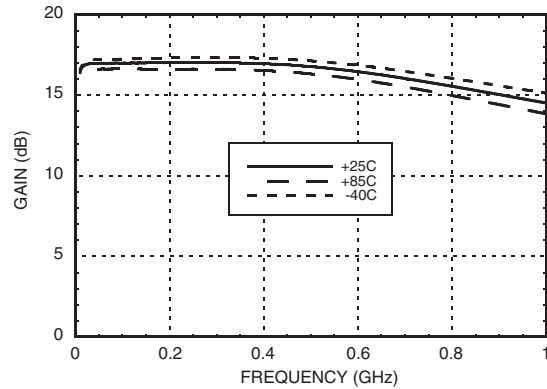

**Gain vs. Vdd [1]**

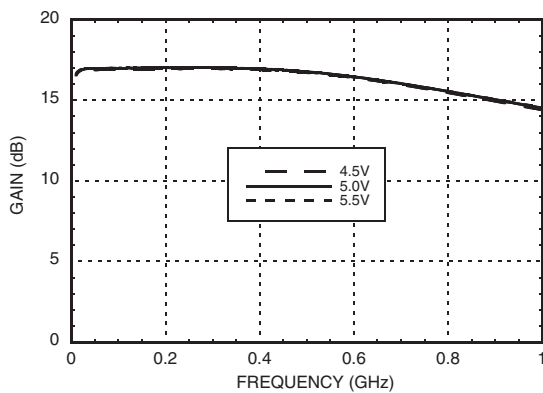

**Gain vs. Rbias**

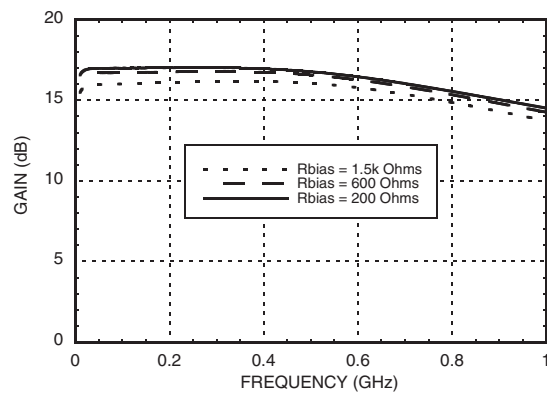

**Return Loss vs. Temperature [1]**

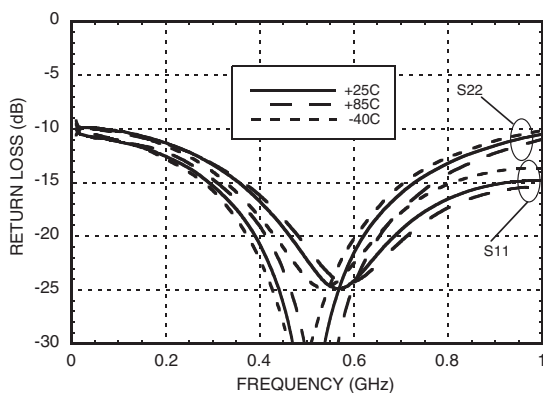

**Return Loss vs. Vdd [1]**

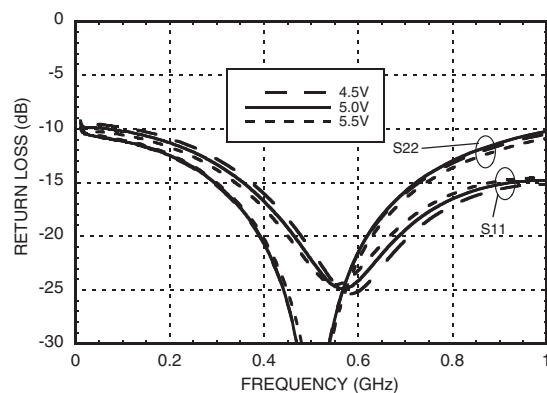

[1] Rbias=R1=200 Ohms. See application circuit

**Return Loss vs. Rbias**

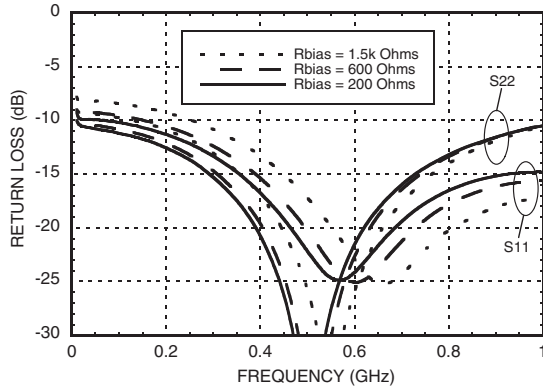

**Isolation vs. Rbias**

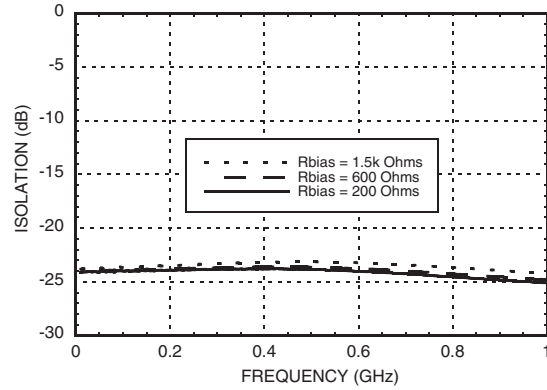

**Noise Figure vs. Temperature [1]**

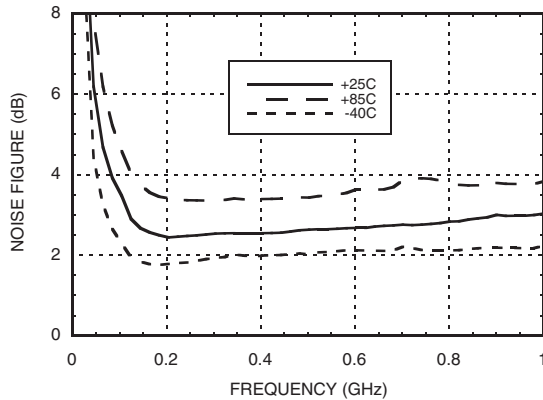

**Noise Figure vs. Temperature for Low Frequencies [1][2]**

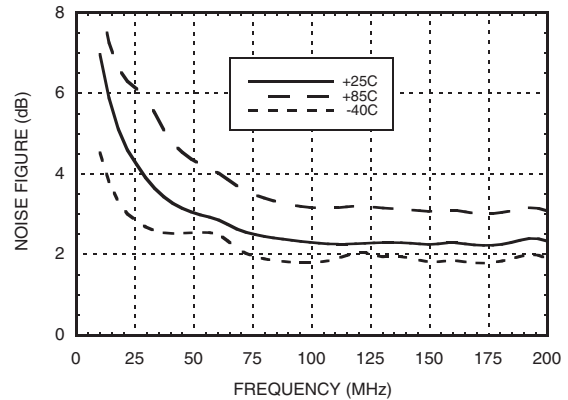

**Noise Figure vs. Vdd [1]**

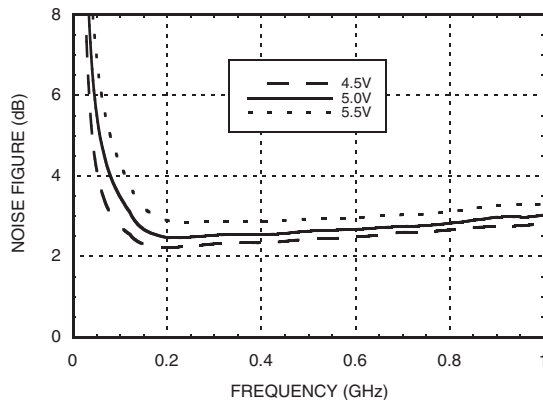

**Noise Figure vs. Vdd for Low Frequencies [1][2]**

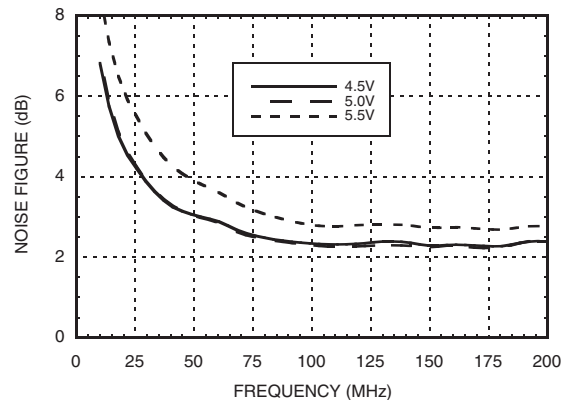

[1] Rbias=R1=200 Ohms. See application circuit.

[2] See application circuit for the tune for low frequencies.



**GaAs pHEMT 50 / 75 Ohm  
DIFFERENTIAL AMPLIFIER, 0.04 - 1 GHz**

**50 Ohm Data**

**Noise Figure vs. Rbias**

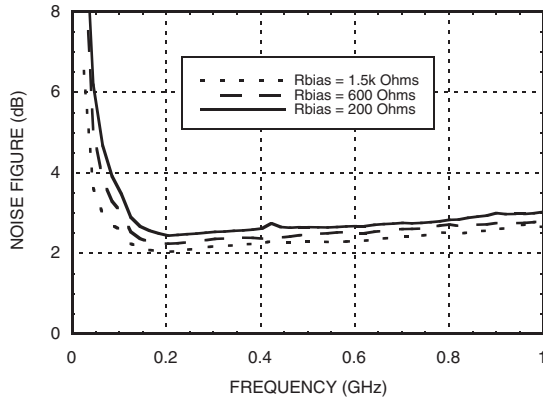

**Noise Figure vs. Rbias for Low Frequencies [2]**

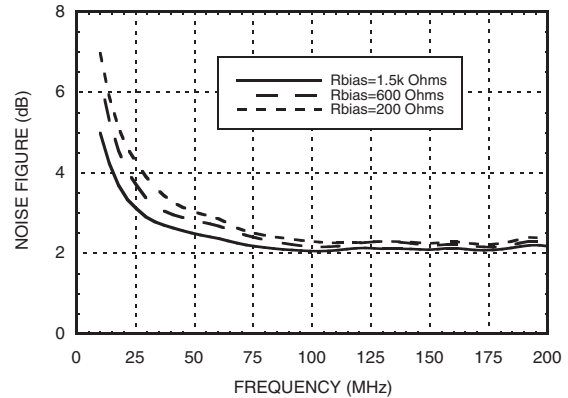

**P1dB vs. Temperature [1]**

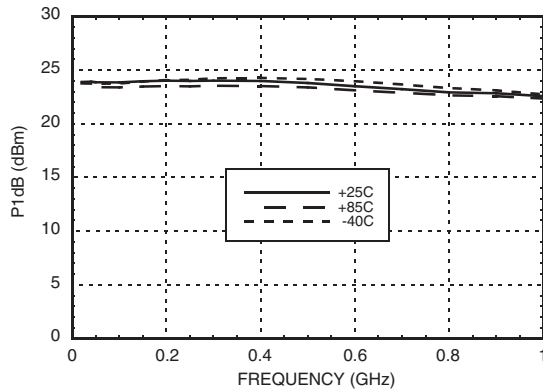

**P1dB vs. Vdd [1]**

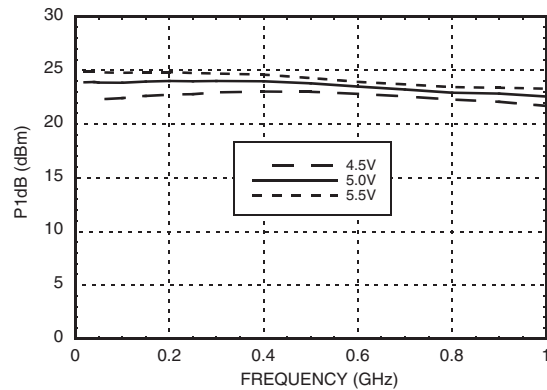

**P1dB vs. Rbias [1]**

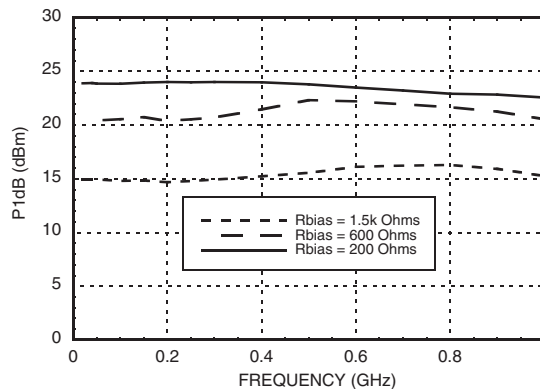

[1] Rbias=R1=200 Ohms. See application circuit.

[2] See application circuit for the tune for low frequencies.

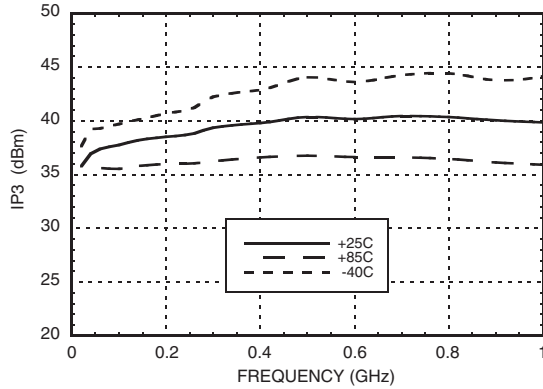
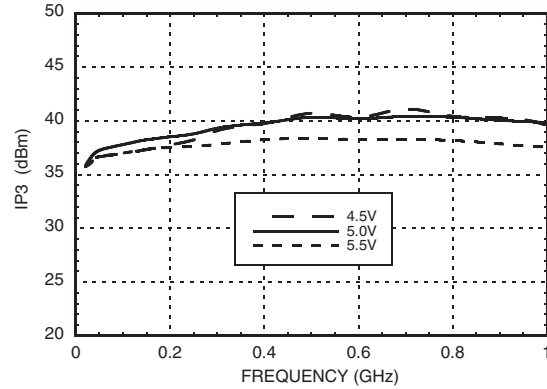
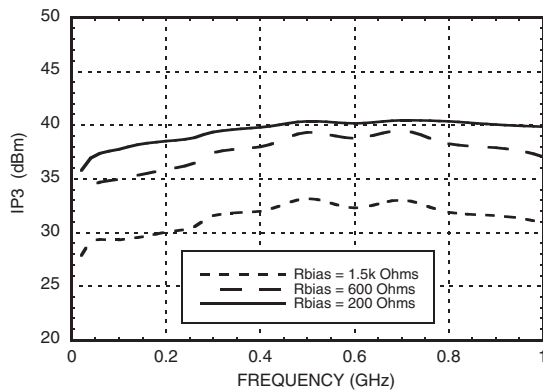
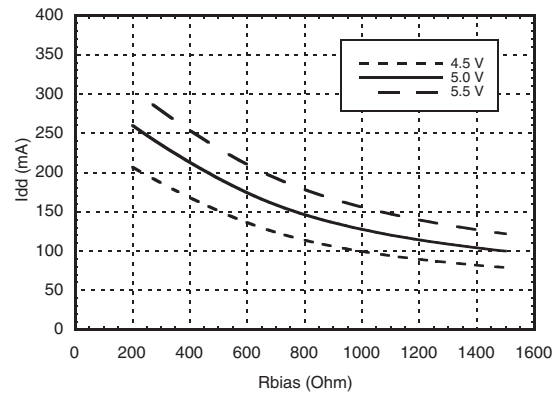
**Output IP3 vs. Temperature [1]**

**Output IP3 vs. Vdd [1]**

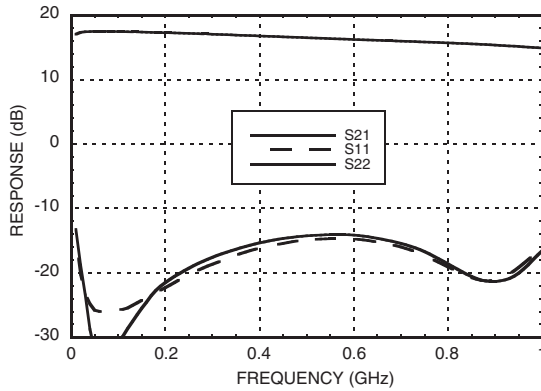
**Output IP3 vs. Rbias**

**I<sub>dd</sub> vs. R<sub>bias</sub>**

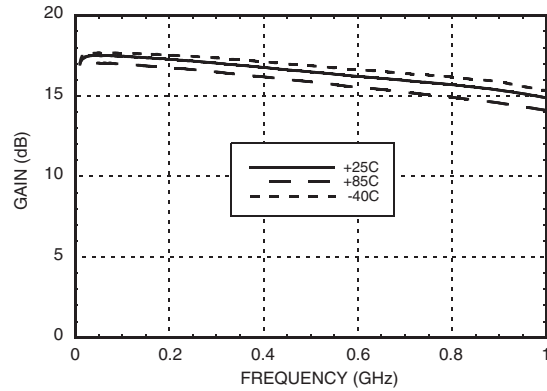
 [1] R<sub>bias</sub>=R<sub>1</sub>=200 Ohms. See application circuit

**Gain & Return Loss [1]**



**Gain vs. Temperature [1]**



**Gain vs. Vdd [1]**

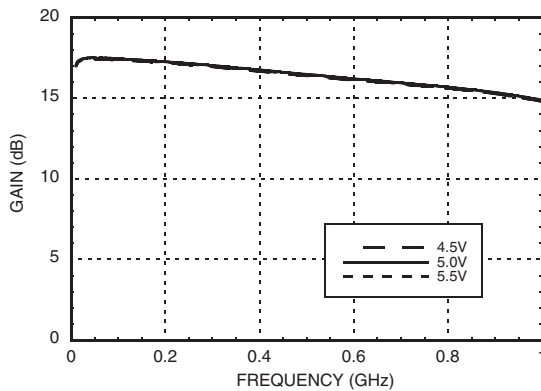

**Gain vs. Rbias**

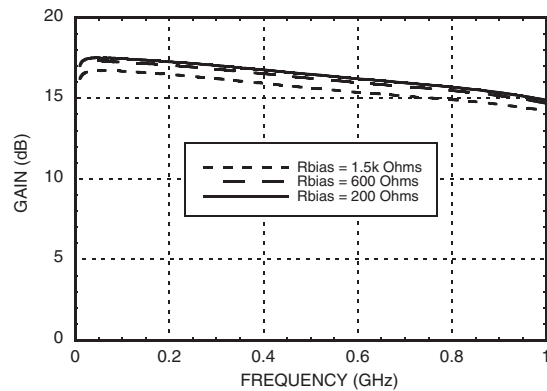

**Return Loss vs. Temperature [1]**

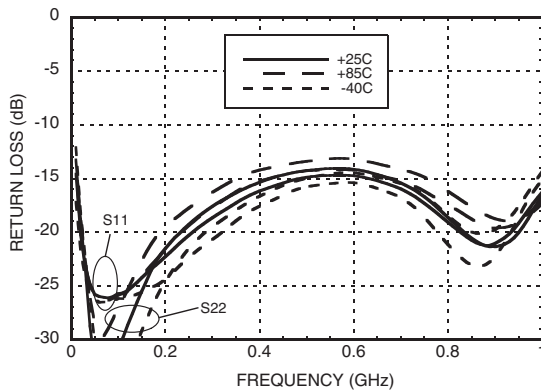

**Return Loss vs. Vdd [1]**

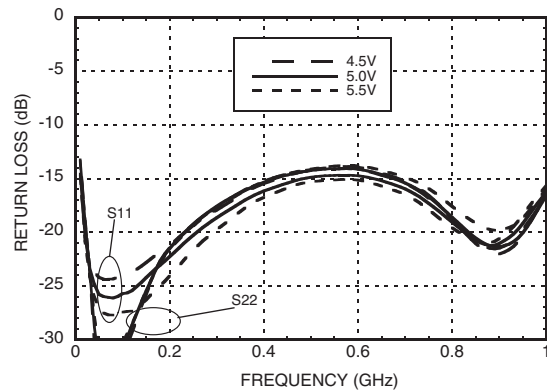

[1] Rbias=R1=200 Ohms. See application circuit



## GaAs pHEMT 50 / 75 Ohm DIFFERENTIAL AMPLIFIER, 0.04 - 1 GHz

### 75 Ohm Data

**Return Loss vs. Rbias**

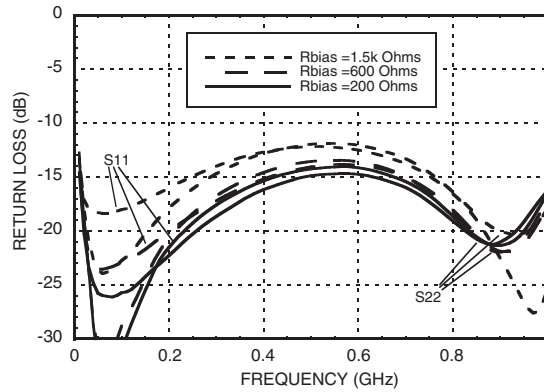

**Noise Figure vs. Temperature [1]**

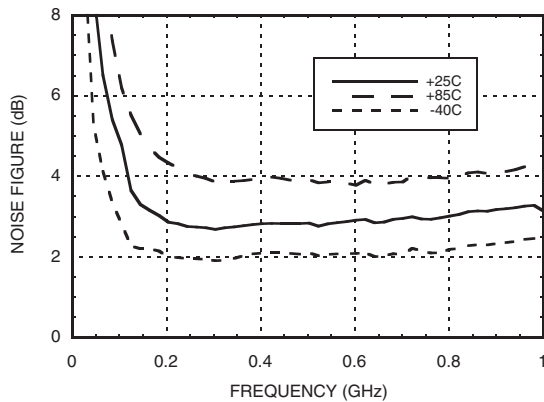

**Noise Figure vs. Temperature for Low Frequencies [1][2]**

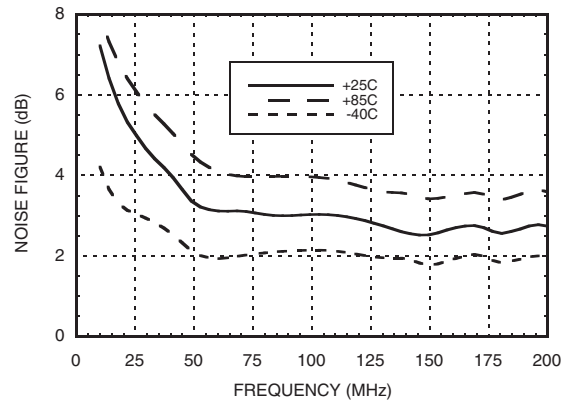

**Noise Figure vs. Vdd [1]**

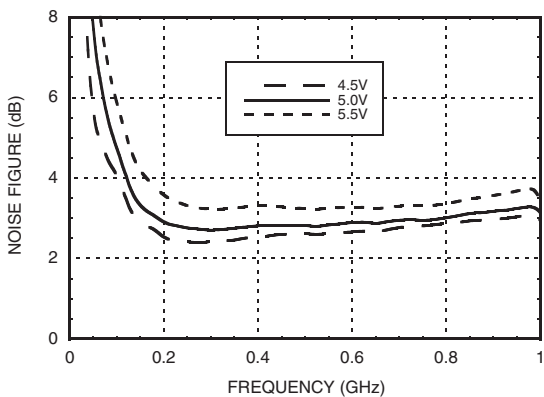

**Noise Figure vs. Vdd for Low Frequencies [1][2]**

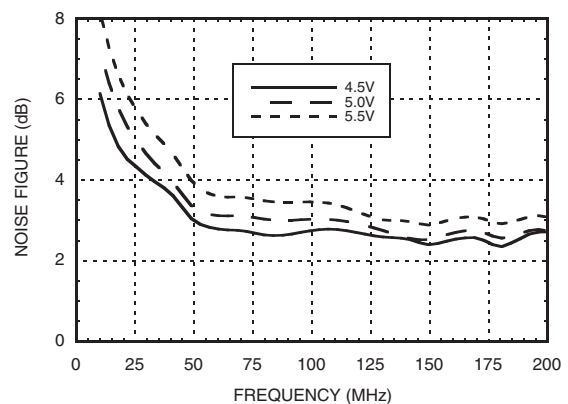

[1] Rbias=R1=200 Ohms. See application circuit.

[2] See application circuit for the tune for low frequencies.

### 75 Ohm Data

**Noise Figure vs. Rbias**

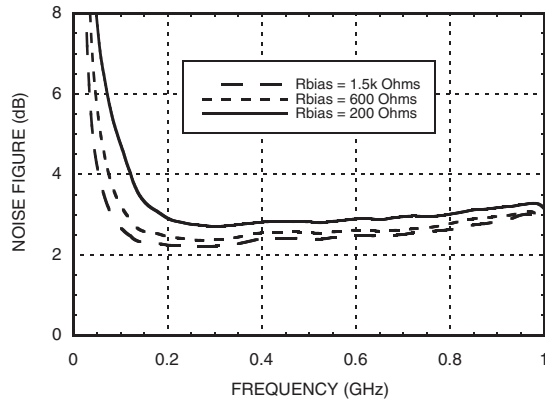

**Noise Figure vs. Rbias for Low Frequencies [1][2]**

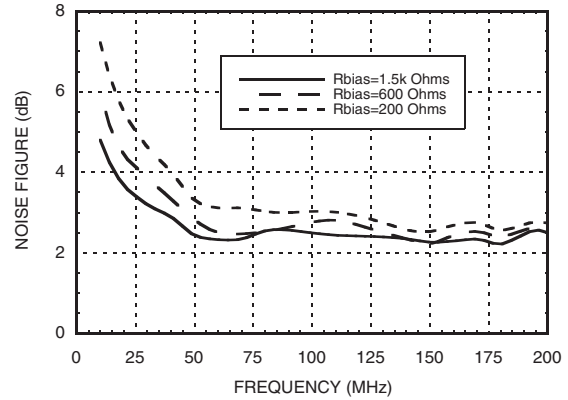

**P1dB vs. Temperature [1]**

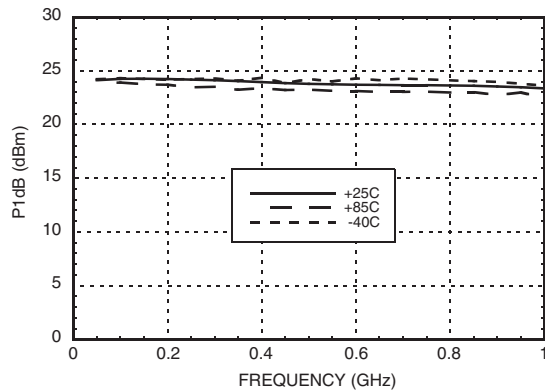

**P1dB vs. Vdd [1]**

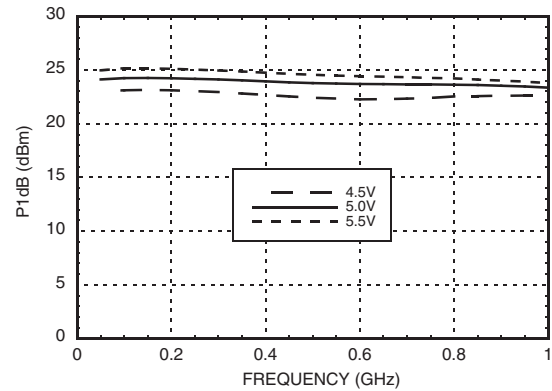

[1] Rbias=R1=200 Ohms. See application circuit.

[2] See application circuit for the tune for low frequencies.





**GaAs pHEMT 50 / 75 Ohm  
DIFFERENTIAL AMPLIFIER, 0.04 - 1 GHz**

**75 Ohm Data**

**P1dB vs. Rbias**

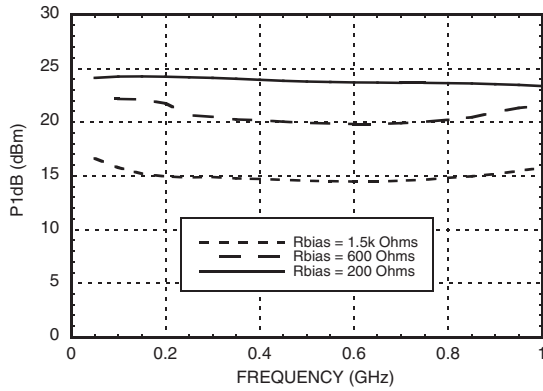

**Output IP3 vs. Temperature [1]**

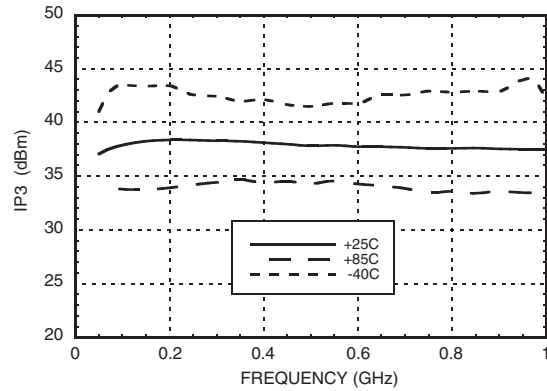

**Output IP3 vs. Vdd [1]**

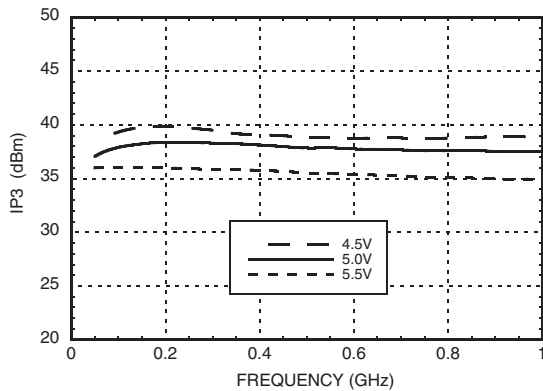

**Output IP3 vs. Rbias**

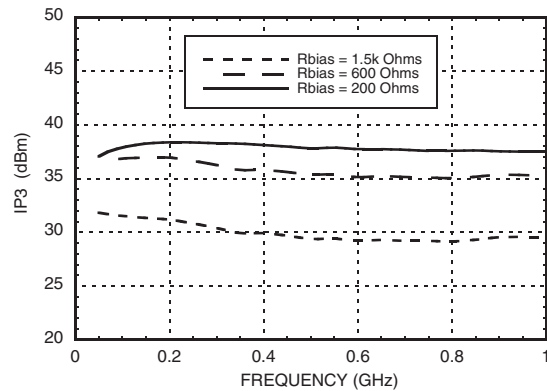

**Input Referred Current Noise vs. Frequency [1]**

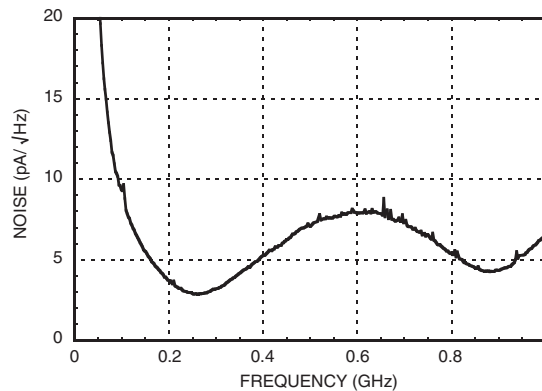

[1] Rbias=R1=200 Ohms. See application circuit

### Absolute Maximum Ratings

|  |               |
|--|---------------|
| Drain Bias Voltage   | 5.5 Vdc       |
| RF Input Power (RFIN)  | +20 dBm       |
| Channel Temperature  | 150 °C        |
| Continuous P <sub>diss</sub> (T=85 °C)<br>(derate 33.21 mW/ °C Above +85 °C) | 2.16W         |
| Thermal Resistance<br>(channel to ground paddle)                             | 30.11 °C/W    |
| Storage Temperature  | -65 to 150 °C |
| Operating Temperature  | -40 to +85 °C |
| ESD Sensitivity (HBM)  | Class 1A      |

### Outline Drawing

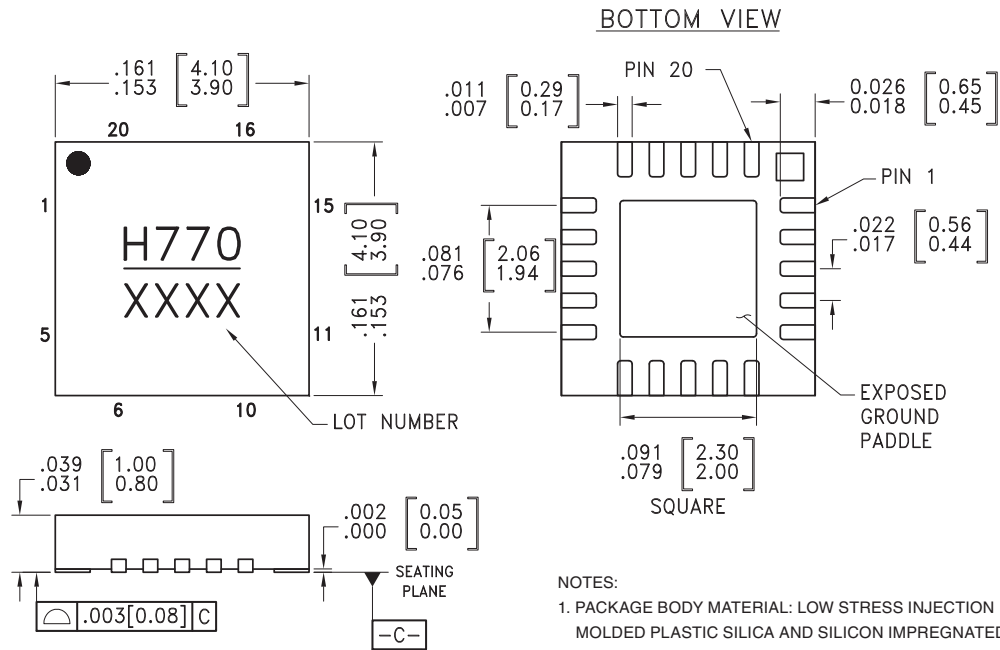

**NOTES:**

1. PACKAGE BODY MATERIAL: LOW STRESS INJECTION MOLDED PLASTIC SILICA AND SILICON IMPREGNATED.
2. LEAD AND GROUND PADDLE MATERIAL: COPPER ALLOY.
3. LEAD AND GROUND PADDLE PLATING: 100% MATTE TIN
4. DIMENSIONS ARE IN INCHES [MILLIMETERS].
5. LEAD SPACING TOLERANCE IS NON-CUMULATIVE.
6. PAD BURR LENGTH SHALL BE 0.15mm MAX. PAD BURR HEIGHT SHALL BE 0.05mm MAX.
7. PACKAGE WARP SHALL NOT EXCEED 0.05mm
8. ALL GROUND LEADS AND GROUND PADDLE MUST BE SOLDERED TO PCB RF GROUND.
9. REFER TO HITTITE APPLICATION NOTE FOR SUGGESTED PCB LAND PATTERN.

### Package Information

| Part Number | Package Body Material                              | Lead Finish   | MSL Rating          | Package Marking <sup>[1]</sup> |
|-------------|--|---------------|---------------------|--------------------------------|
| HMC770LP4BE | RoHS-compliant Low Stress Injection Molded Plastic | 100% matte Sn | MSL3 <sup>[2]</sup> | H770<br>XXXX                   |



[1] 4-Digit lot number XXXX

[2] Max peak reflow temperature of 260 °C

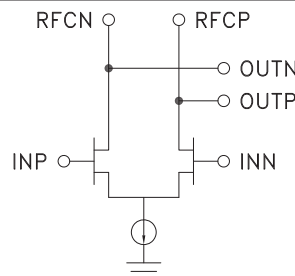
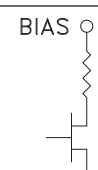

## GaAs pHEMT 50 / 75 Ohm DIFFERENTIAL AMPLIFIER, 0.04 - 1 GHz

### Pin Descriptions

| Pin Number                            | Function   | Description   | Interface Schematic  |
|---------------------------------------|------------|---|--|
| 1, 5                                  | INN, INP   | This pin is DC coupled<br>An off chip DC blocking capacitor is required   |   |
| 11, 15                                | OUTN, OUTP | This pin is DC coupled<br>An off chip DC blocking capacitor is required   |  |
| 9, 17                                 | RFCN, RFCP | RF Choke and DC Bias (Vdd) for the output stage   |  |
| 2 - 4, 6 - 8, 10, 12 - 14, 16, 18, 19 | N/C        | These pins may be left unconnected.   |  |
| 20                                    | BIAS       | This pin is used to set the DC current of the amplifier by selection of the external bias resistor.<br>See application circuit. |   |
| Package Base                          | GND        | Package bottom must be connected to RF/DC ground.   |  |

### Application Circuit - for Transimpedance Amplifier Mode for use with 75 Ohm Evaluation Board

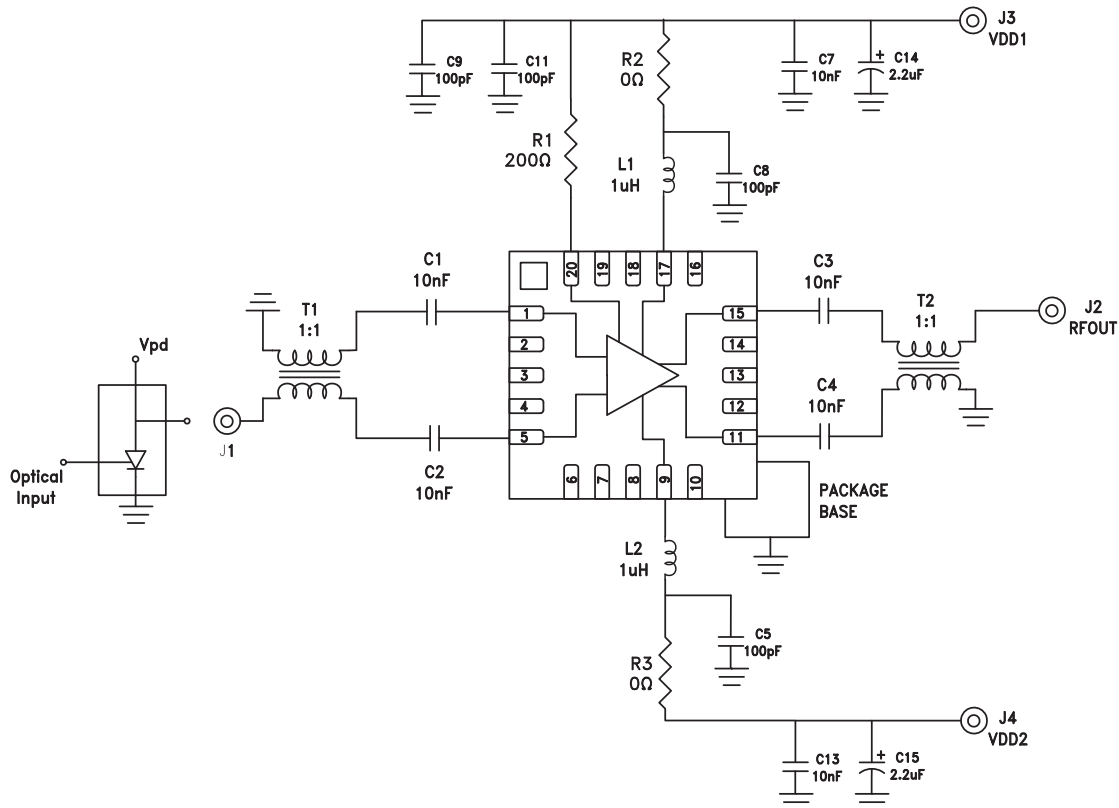



## GaAs pHEMT 50 / 75 Ohm DIFFERENTIAL AMPLIFIER, 0.04 - 1 GHz

**Application Circuit -  
for Differential Amplifier Mode for use with either 50 or 75 Ohm Evaluation Board**

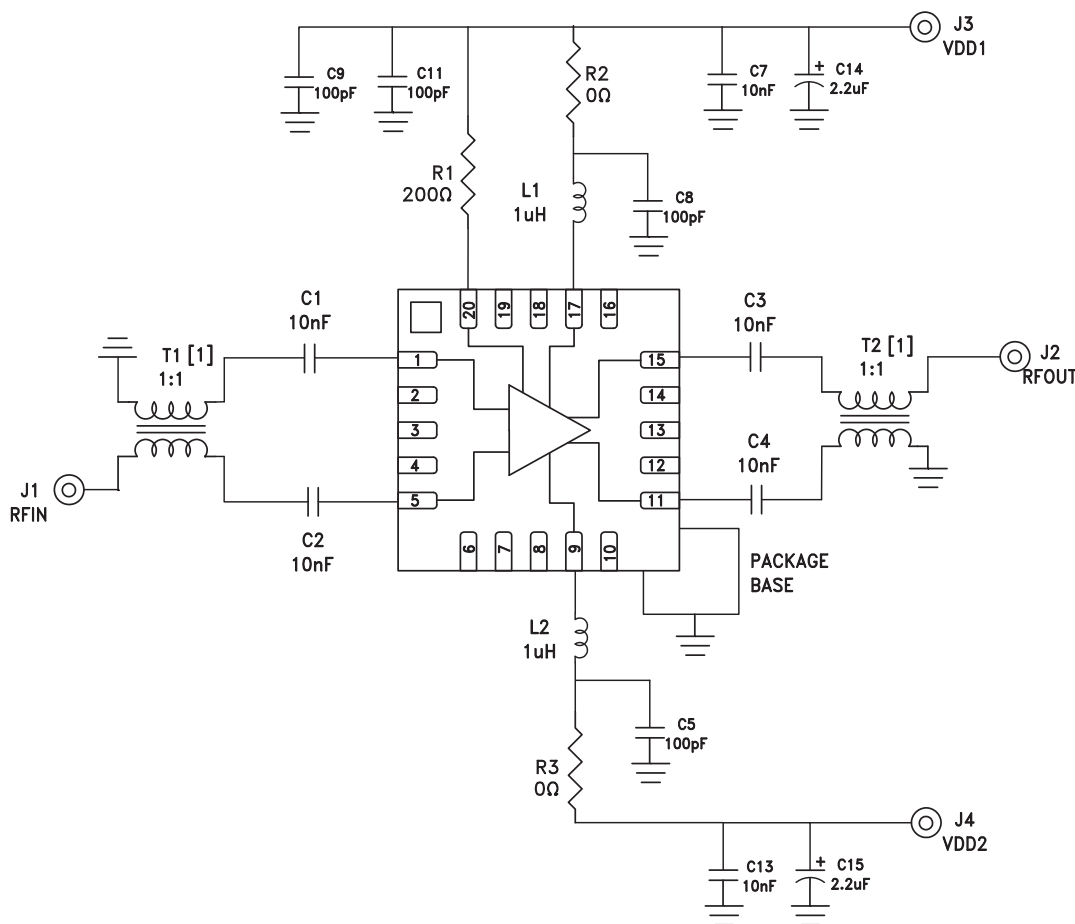

### Components for Selected Options

| Tune Option           | 50 Ohm        | 50 Ohm Low Frequency | 75 Ohm      | 75 Ohm Low Frequency |
|-----------------------|---------------|----------------------|-------------|----------------------|
| Evaluation PCB Number | 125980        | 127930               | 121737      | 127931               |
| J1, J2                | SMA connector |                      | F connector |                      |
| T1, T2 [1]            | ETC 1-1-13    | ETC1-1T-5TR          | ETC 1-1-13  | ETC1-1T-5TR          |

[1] 1:1 Balun

Balun ETC1-1-13 is recommended for broadband and high frequency applications with the limitation that ETC1-1-13 degrades noise performance below 200 MHz.

Balun ETC1-1T-5TR is recommended for low frequency applications with the limitation that ETC1-1T-5TR degrades gain above 500 MHz.

**Evaluation PCB - 50 Ohm**

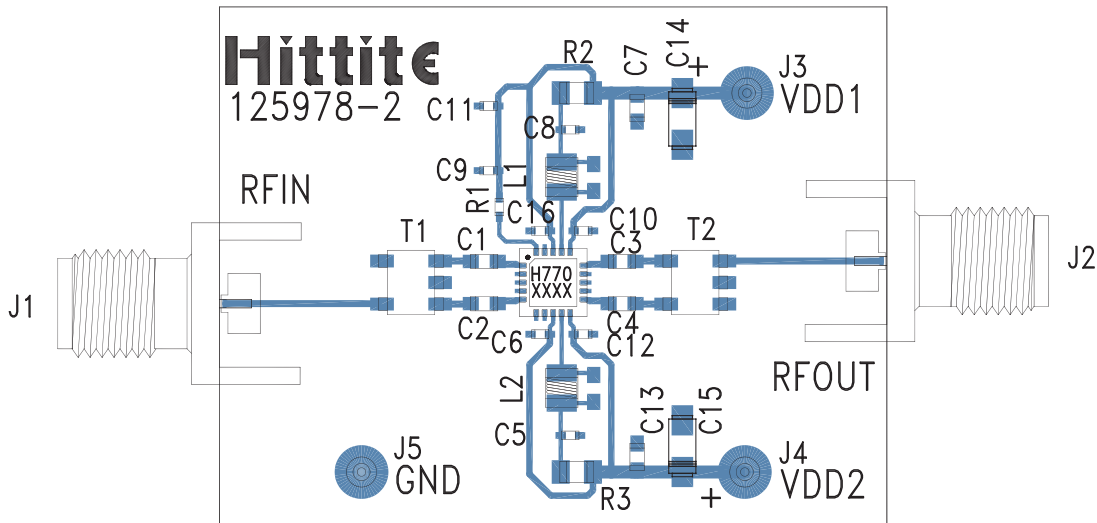

**List of Materials for Evaluation PCB [1]**

| Item                  | Description                      |
|-----------------------|----------------------------------|
| J1, J2                | Johnson SMA Connector            |
| J3 - J5               | DC Pin                           |
| C1 - C4, C7, C13      | 10 nF Capacitor, 0603 Pkg.       |
| C5, C6, C8 - C12, C16 | 100 pF Capacitor, 0402 Pkg.      |
| C10, C12              | 10 nF Capacitor, 0402 Pkg.       |
| C14, C15              | 2.2 μF Capacitor, Tantalum       |
| L1, L2                | 1 uH Inductor, 0805 Pkg.         |
| R1 (Rbias)            | 200 Ohm Resistor, 0402 Pkg.      |
| R2, R3                | 0 Ohm Resistor, 0805 Pkg.        |
| T1, T2 [2]            | 1:1 Transformer                  |
| U1                    | HMC770LP4BE Gain Block Amplifier |
| PCB [3]               | 125978 Evaluation PCB            |

[1] When requesting an evaluation board, please reference the appropriate evaluation PCB number listed in the table "Components for Selected Options."

[2] Please refer to "Components for Selected Options" table for values

[3] Circuit Board Material: Rogers 4350

The circuit board used in the final application should use RF circuit design techniques. Signal lines should have 50 Ohm impedance while the package ground leads and exposed paddle should be connected directly to the ground plane similar to that shown. A sufficient number of via holes should be used to connect the top and bottom ground planes. The evaluation circuit board shown is available from Hittite upon request.



**GaAs pHEMT 50 / 75 Ohm  
DIFFERENTIAL AMPLIFIER, 0.04 - 1 GHz**

**Evaluation PCB - 75 Ohm**

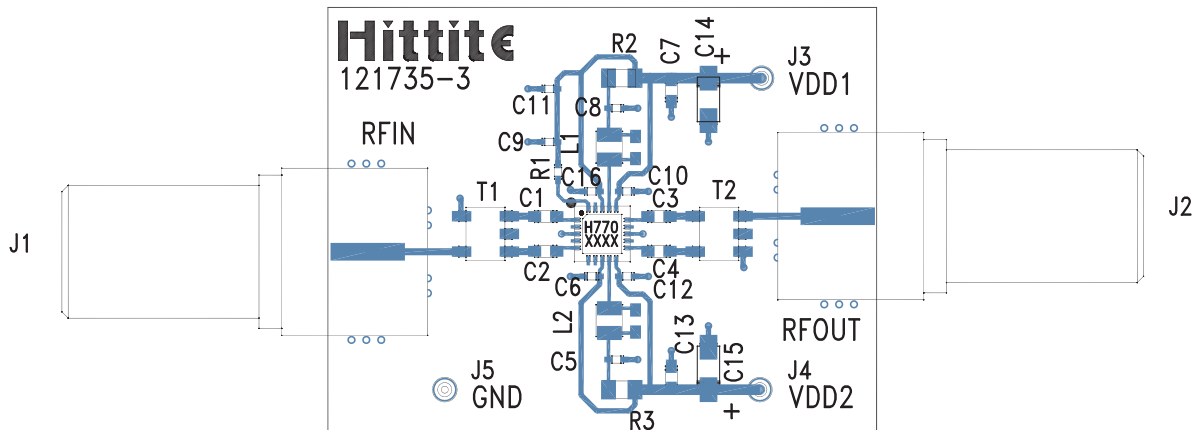

**List of Materials for Evaluation PCB [1]**

| Item                  | Description                      |
|-----------------------|----------------------------------|
| J1, J2                | F-Connector                      |
| J3 - J5               | DC Pin                           |
| C1 - C4, C7, C13      | 10 nF Capacitor, 0603 Pkg.       |
| C5, C6, C8 - C12, C16 | 100 pF Capacitor, 0402 Pkg.      |
| C10, C12              | 10 nF Capacitor, 0402 Pkg.       |
| C14, C15              | 2.2 $\mu$ F Capacitor, Tantalum  |
| L1, L2                | 1 uH Inductor, 0805 Pkg.         |
| R1 (Rbias)            | 200 Ohm Resistor, 0402 Pkg.      |
| R2, R3                | 0 Ohm Resistor, 0805 Pkg.        |
| T1, T2 [2]            | 1:1 Transformer                  |
| U1                    | HMC770LP4BE Gain Block Amplifier |
| PCB [3]               | 121735 Evaluation PCB            |

[1] When requesting an evaluation board, please reference the appropriate evaluation PCB number listed in the table "Components for Selected Options."

[2] Please refer to "Components for Selected Options" table for values

[3] Circuit Board Material: Rogers 4350

The circuit board used in the final application should use RF circuit design techniques. Signal lines should have 75 ohm impedance while the package ground leads and exposed paddle should be connected directly to the ground plane similar to that shown. A sufficient number of via holes should be used to connect the top and bottom ground planes. The evaluation circuit board shown is available from Hittite upon request.

Компания «Океан Электроники» предлагает заключение долгосрочных отношений при поставках импортных электронных компонентов на взаимовыгодных условиях!

Наши преимущества:

- Поставка оригинальных импортных электронных компонентов напрямую с производств Америки, Европы и Азии, а так же с крупнейших складов мира;
- Широкая линейка поставок активных и пассивных импортных электронных компонентов (более 30 млн. наименований);
- Поставка сложных, дефицитных, либо снятых с производства позиций;
- Оперативные сроки поставки под заказ (от 5 рабочих дней);
- Экспресс доставка в любую точку России;
- Помощь Конструкторского Отдела и консультации квалифицированных инженеров;
- Техническая поддержка проекта, помощь в подборе аналогов, поставка прототипов;
- Поставка электронных компонентов под контролем ВП;
- Система менеджмента качества сертифицирована по Международному стандарту ISO 9001;
- При необходимости вся продукция военного и аэрокосмического назначения проходит испытания и сертификацию в лаборатории (по согласованию с заказчиком);
- Поставка специализированных компонентов военного и аэрокосмического уровня качества (Xilinx, Altera, Analog Devices, Intersil, Interpoint, Microsemi, Actel, Aeroflex, Peregrine, VPT, Syfer, Eurofarad, Texas Instruments, MS Kennedy, Miteq, Cobham, E2V, MA-COM, Hittite, Mini-Circuits, General Dynamics и др.);

Компания «Океан Электроники» является официальным дистрибьютором и эксклюзивным представителем в России одного из крупнейших производителей разъемов военного и аэрокосмического назначения «JONHON», а так же официальным дистрибьютором и эксклюзивным представителем в России производителя высокотехнологичных и надежных решений для передачи СВЧ сигналов «FORSTAR».



## JONHON

«JONHON» (основан в 1970 г.)

Разъемы специального, военного и аэрокосмического назначения:

(Применяются в военной, авиационной, аэрокосмической, морской, железнодорожной, горно- и нефтедобывающей отраслях промышленности)

«FORSTAR» (основан в 1998 г.)

ВЧ соединители, коаксиальные кабели, кабельные сборки и микроволновые компоненты:

(Применяются в телекоммуникациях гражданского и специального назначения, в средствах связи, РЛС, а так же военной, авиационной и аэрокосмической отраслях промышленности).



Телефон: 8 (812) 309-75-97 (многоканальный)

Факс: 8 (812) 320-03-32

Электронная почта: [ocean@oceanchips.ru](mailto:ocean@oceanchips.ru)

Web: <http://oceanchips.ru/>

Адрес: 198099, г. Санкт-Петербург, ул. Калинина, д. 2, корп. 4, лит. А