

Product Overview

The QPC6742 is a 75Ω Silicon on Insulator (SOI) single-pole, four throw (SP4T) switch designed for use in CATV, satellite set top, and other high-performance communications systems. It offers a high isolation symmetric topology with excellent linearity and power handling capability. No blocking caps are necessary on the RF ports. QPC6742 is packaged in a convenient 1.8mm x 1.8mm QFN package

Functional Block Diagram

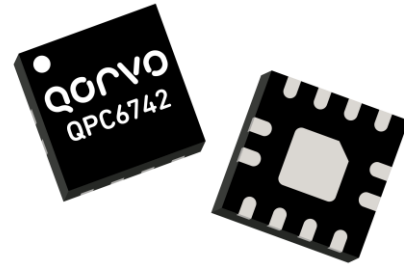
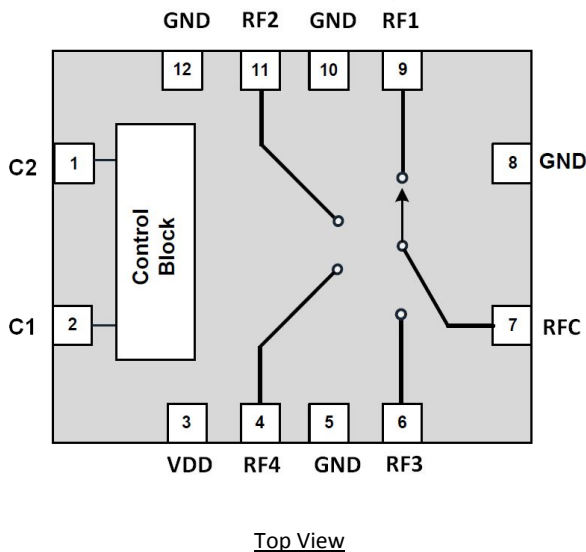

12 Pin 1.8 x 1.8mm QFN Package

Key Features

- 5 MHz to 2000MHz Operation
- Low Insertion Loss: 0.35dB at 800MHz
- No Blocking Caps Required Unless Voltage on RF Line
- High Isolation: 34dB at 800MHz
- High Input IP3: 82dBm at 850MHz
- 2kV ESD
- +1.8V Logic Compatible
- 3V to 5V Operation

Applications

- MDU Amplifiers
- Point To Point
- Optical Nodes
- Set Top Box
- PCTV
- Multi-tuner DVR

Ordering Information

Part No.	Description
QPC6742SQ	Sample bag with 25 pieces
QPC6742SR	7" Reel with 100 pieces
QPC6742TR7	7" Reel with 2500 pieces
QPC6742PCK	5 – 2000MHz PCBA with 5 pc. sample bag

Absolute Maximum Ratings

Parameter	Rating
Control Voltage ($V_{C1,C2}$)	+3.0V
Supply Voltage (V_{DD})	+6.0V
Maximum CW Input Power at 25°C	+35dBm
Max Input Power During Active Switching	+27dBm
Storage Temperature Range	-40 to +150°C

Exceeding any one or a combination of the Absolute Maximum Rating conditions may cause permanent damage to the device. Extended application of Absolute Maximum Rating conditions to the device may reduce device reliability.

Recommended Operating Conditions

Parameter	Min	Typ	Max	Units
Supply Voltage, V_{DD}	+2.7	+3	+5.5	V
Temperature Range	-40		+85	°C

Electrical specifications are measured at specified test conditions. Specifications are not guaranteed over all recommended operating conditions.

Electrical Specifications

Parameter	Conditions ⁽¹⁾	Min	Typ	Max	Units
Frequency Range		5		2000	MHz
Insertion Loss (RFC to RF1/RF2/RF3/RF4)	5MHz		0.2		dB
	50MHz		0.3		
	800MHz		0.35		
	1.2GHz		0.4		
	2GHz		0.45		
Isolation (RFC to RF1/RF2/RF3/RF4)	5MHz		49		dB
	50MHz		58		
	800MHz		34		
	1.2GHz		30		
	2GHz		26		
Isolation (RF1/RF2/RF3/RF4)	5MHz		47		dB
	50MHz		51		
	800MHz		29		
	1.2GHz		25		
	2GHz		21		
Return Loss	5MHz		43		dB
	50MHz		36		
	800MHz		19		
	1.2GHz		20		
	2GHz		19		

Notes:

1. Test Conditions Unless Otherwise Specified: $T_A = +25^\circ\text{C}$, $V_{DD} = +5\text{V}$, $V_{C1,C2} = 0/+2.5\text{V}$, 75Ω system.

Electrical Specifications (cont'd.)

Parameter	Conditions ⁽¹⁾	Min	Typ	Max	Units
Input IP3	850MHz +12dBm input power per tone, 30MHz tone spacing		82		dBm
Input IP2	850MHz +12dBm input power per tone, 30MHz tone spacing		130.6		
Input 1dB Compression Point	850MHz		40.2		
Input 0.1dB Compression Point	850MHz		34.0		
MER	75dBmV composite at 885MHz		41.7		dB
CCN	75dBmV composite at 885MHz		55.8		
Switching Speed	10/90% RF		0.6		μs
Switching Speed	50% control to 10/90% RF		1.3		
Turn On Time	Time for VDD = 0V to part ON and RF = 90%		20		
NVG Spurs	F<30MHz		-118		dBm
Harmonics-2nd	5 MHz		-76		dBc
	50MHz		-88		
	850MHz		-129		
	1800MHz		-114		
Harmonics-3rd	5MHz		-97		dBc
	50MHz		-110		
	850MHz		-129		
	1800MHz		-110		

Notes:

1. Test Conditions Unless Otherwise Specified: T_A = +25°C, V_{DD} = +5V, V_{CTL} = 0/+2.5V, 75Ω system. Drive RFC, RFx output.

Electrical Specifications - Power Supply

Parameter	Conditions ⁽¹⁾	Min	Typ	Max	Units
Supply Current (I _{DD})	V _{DD} = +5.0V		65	130	μA
Control Current				5	μA
Control Voltage High		1.3		2.7	V
Control Voltage Low		0		0.45	V

Power Supply Sequencing Requirements

Condition	Sequence
Power Up	Turn on VDD, then C1 and C2, then (20μs or greater), apply RF signal
Power Down	Turn off RF signal, then C1 and C2, turn off VDD

Truth Table

Mode	Control Signals	
	C1	C1
RFC to RF1	High	Low
RFC to RF2	Low	High
RFC to RF3	High	High
RFC to RF4	Low	Low

5-2000 MHz Evaluation Board Schematic (QPC6742PCK)

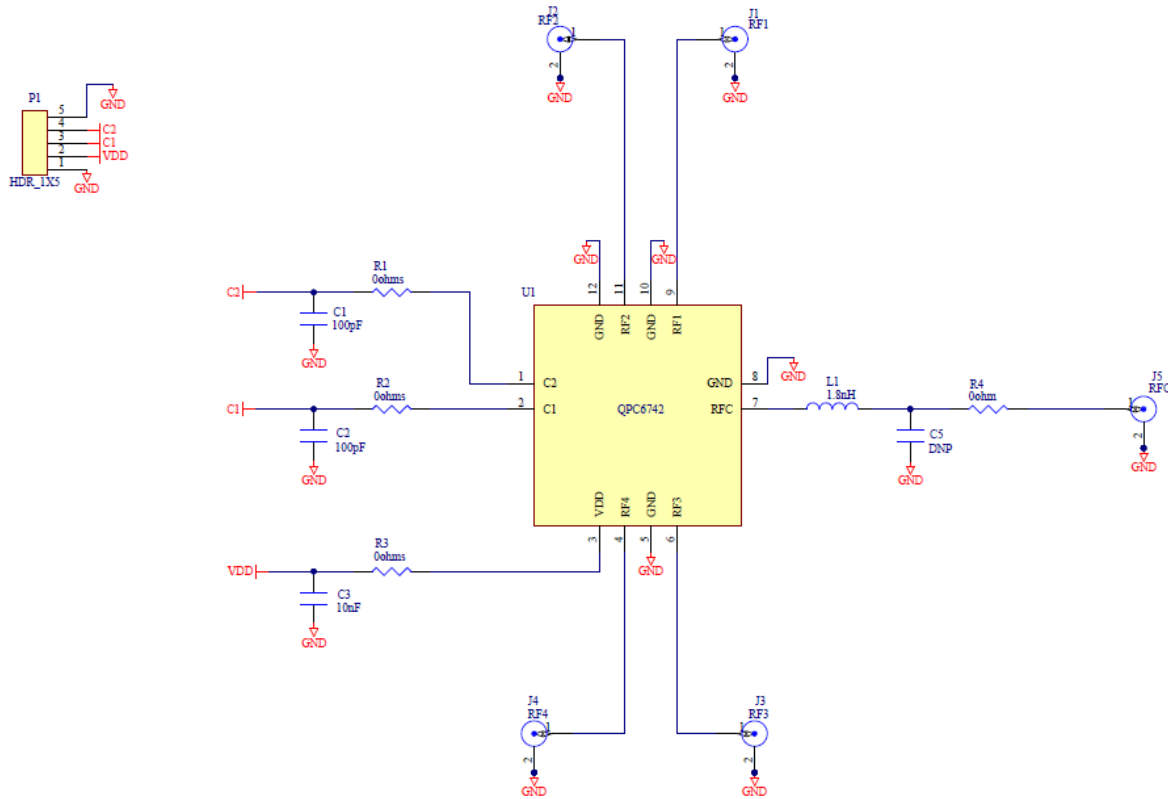

Ref. Designator	Description	Manufacturer	Part Number
PCB	Evaluation Board PCB	Viasystems	QPC6742-4000
U1	75ohm SP4T Switch	Qorvo	QPC6742SB
J1, J2, J3, J4, J5	F Connector, Edge Mount, 75 Ω, 0.065"	Genesis Technology	GT20-300204
R1, R2, R3, R4	0 Ω RES, 0402	Kamaya, Inc	RMC1/16SJPTH
P1	CONN, HDR, ST, PLRZD, 5-PIN, 0.100"	ITW Pancon	MPSS100-5-C
C1, C2	CAP, 100pF, 5%, 50V, COG, 0402	Murata	GRM1555C1H101JA01D
C3	CAP, 10nF, 10%, 25V, X7R, 0402	Murata	GRM155R71E103KA01D
L1	IND, 1.8nH, +/-0.1nH, M/L, Hi-Q, 0201	Taiyo Uden	LG HKQ0603W1N8B-T
C5	DNP	N/A	N/A

Evaluation Board Assembly (QPC6742PCK)

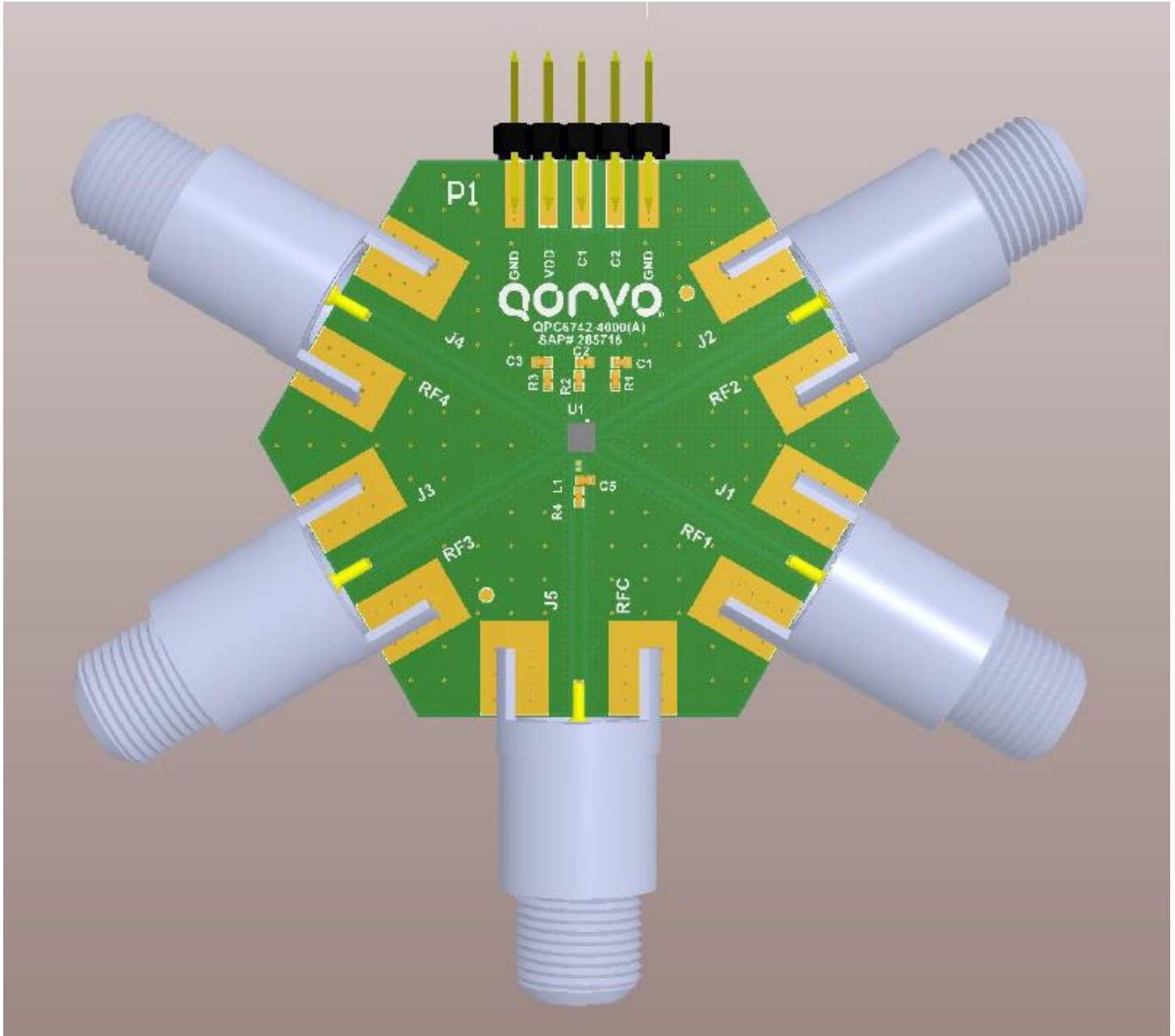

Performance Plots

Test conditions unless otherwise noted: $V_{DD} = +5V$, $V_{C1,C1} = 0 / 2.5V$, Temp = $+25^{\circ}C$, $Z_o = 75\Omega$

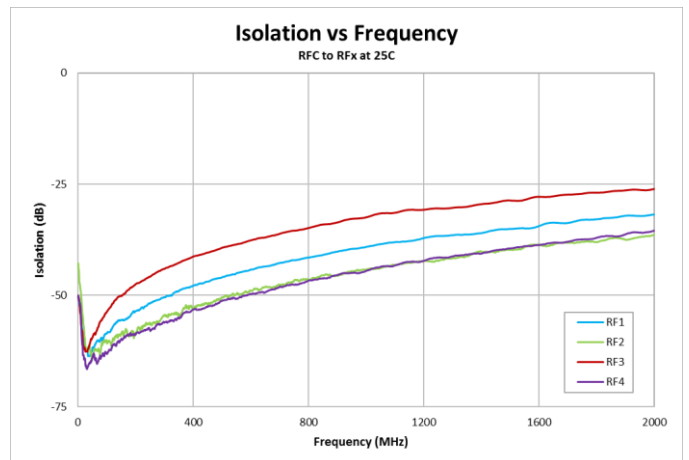
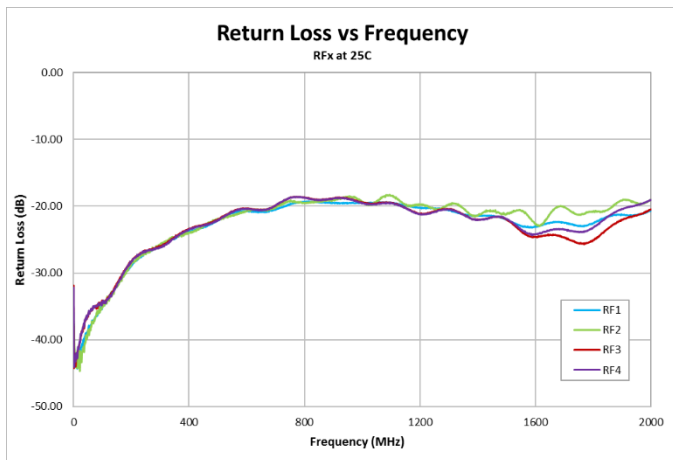
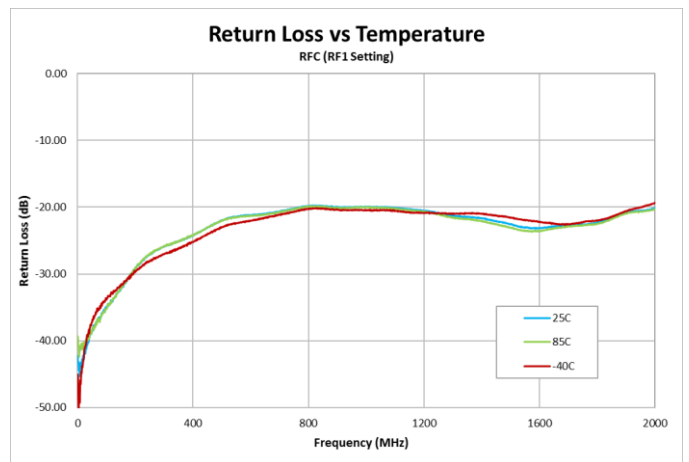
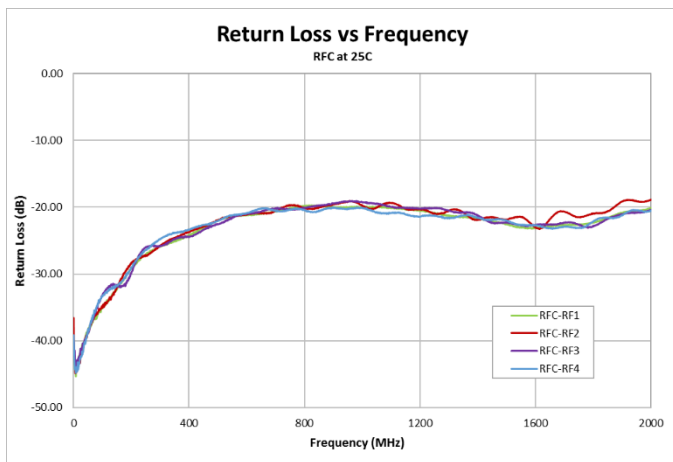
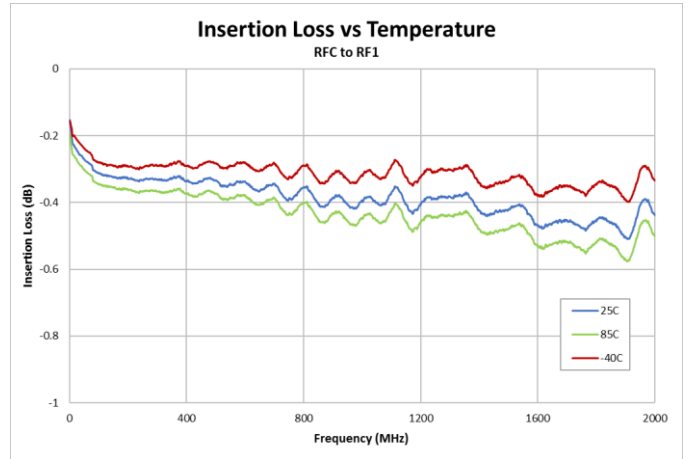
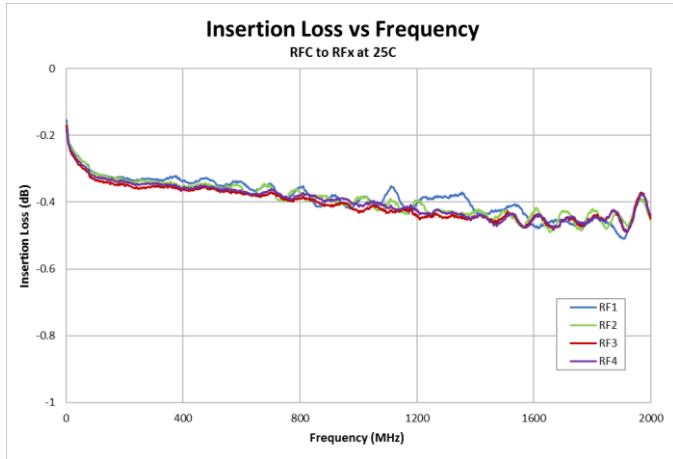

Notes:

1. Insertion Loss plots are loss compensated to remove effects of EVB.

Performance Plots (cont'd.)

Test conditions unless otherwise noted: $V_{DD} = +5V$, $V_{C1,C1} = 0 / 2.5V$, Temp = $+25^{\circ}C$, $Z_0 = 75\Omega$

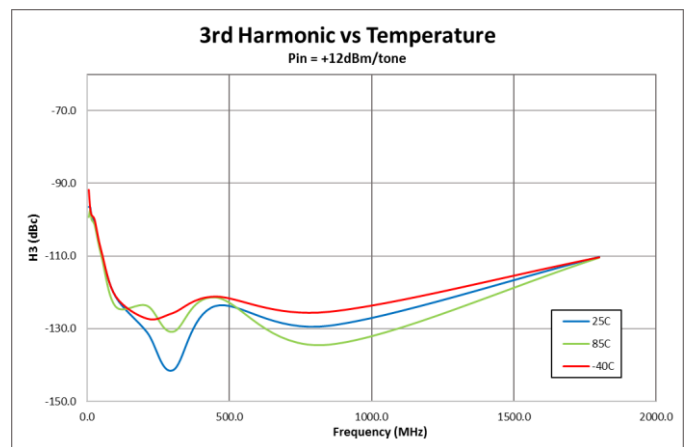
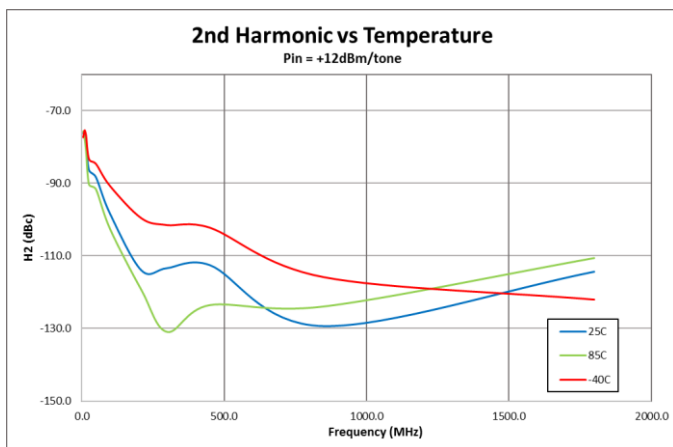
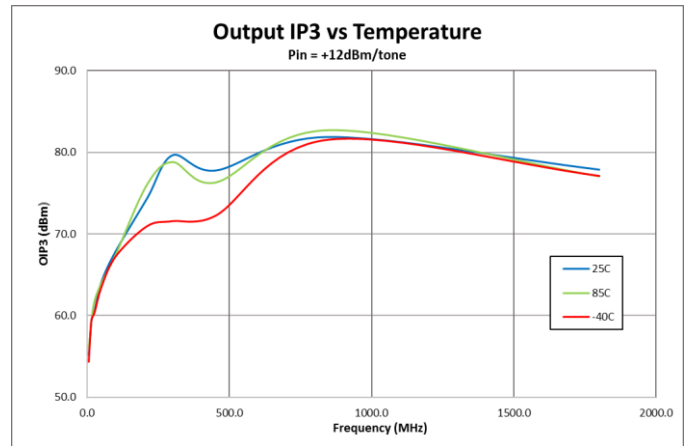
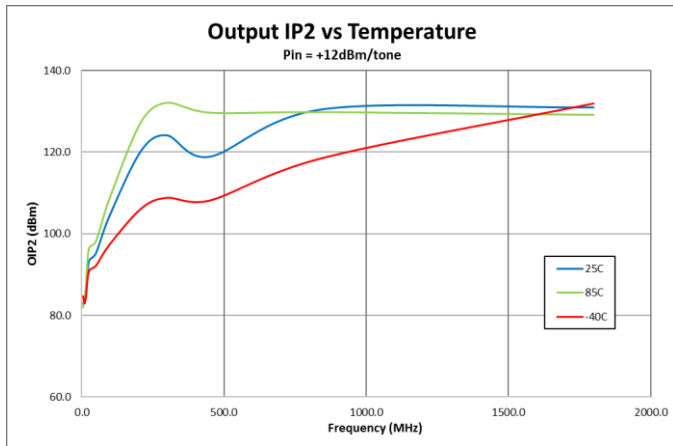
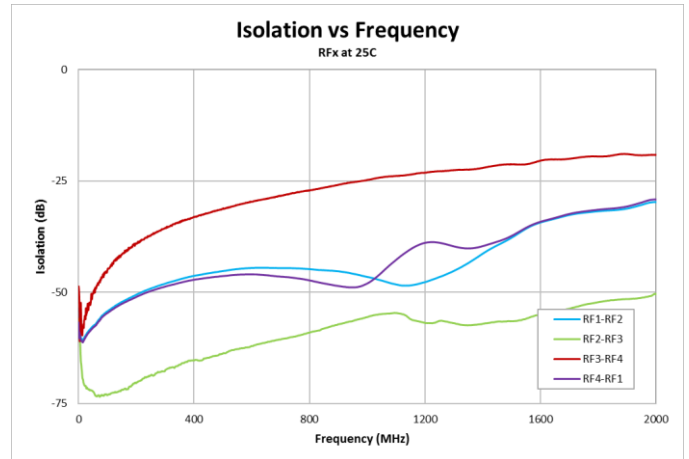
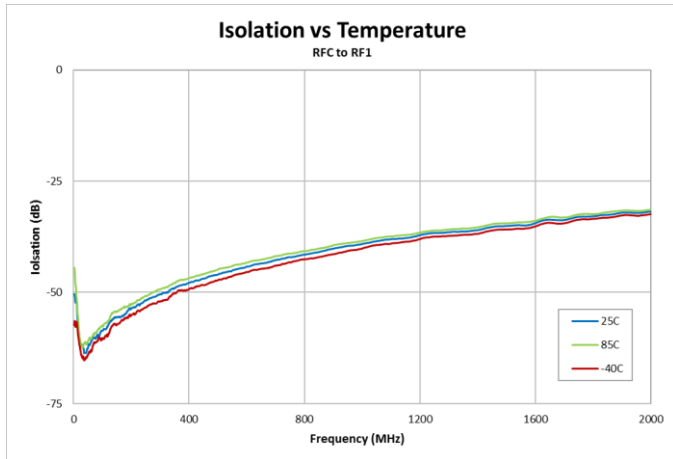

Performance Plots (cont'd.)

Test conditions unless otherwise noted: $V_{DD} = +5V$, $V_{C1,C1} = 0 / 2.5V$, Temp = $+25^{\circ}C$, $Z_o = 75\Omega$

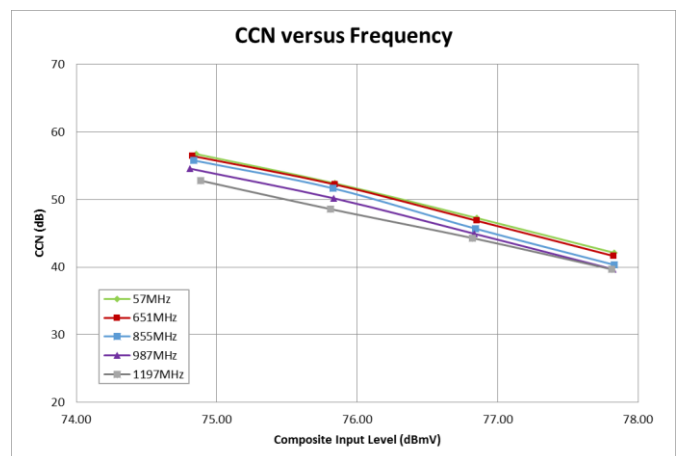
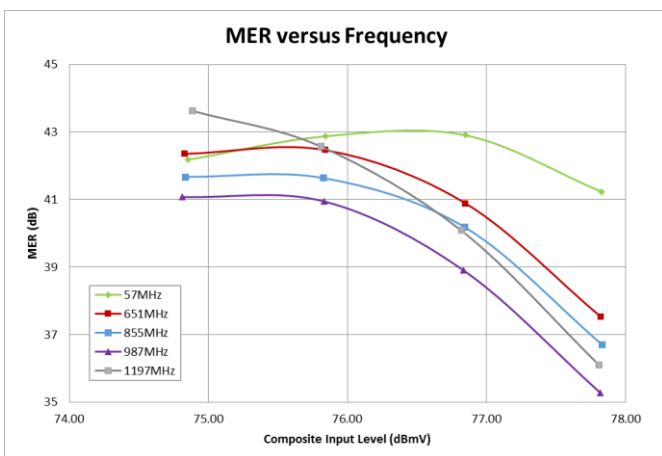
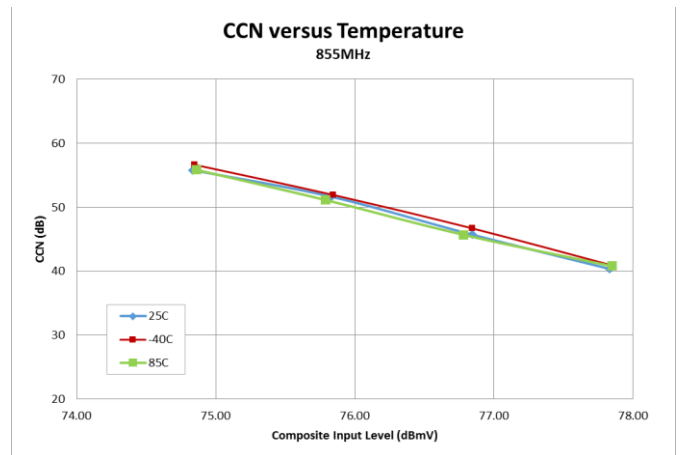
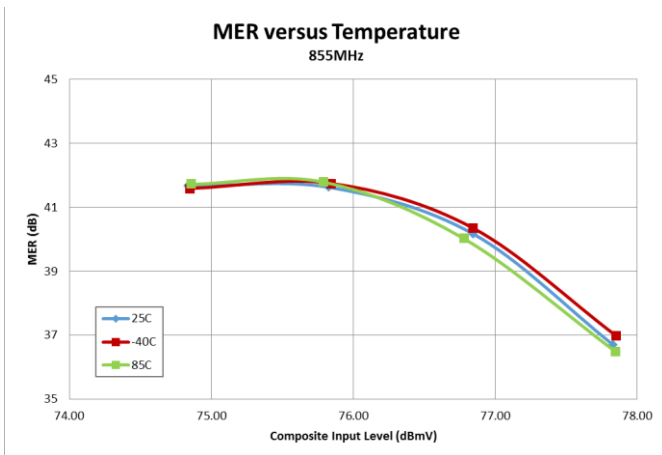
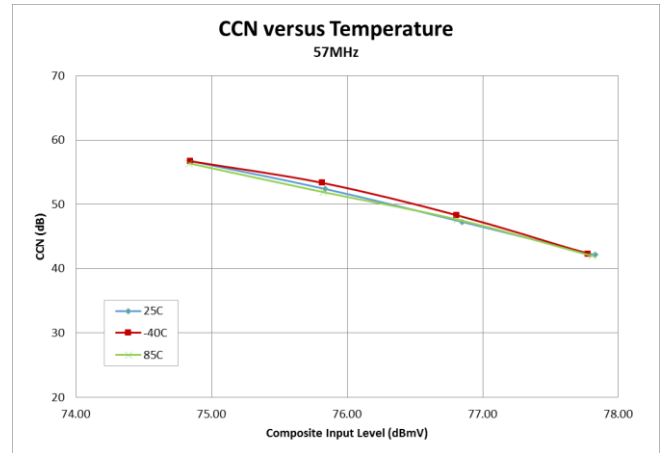
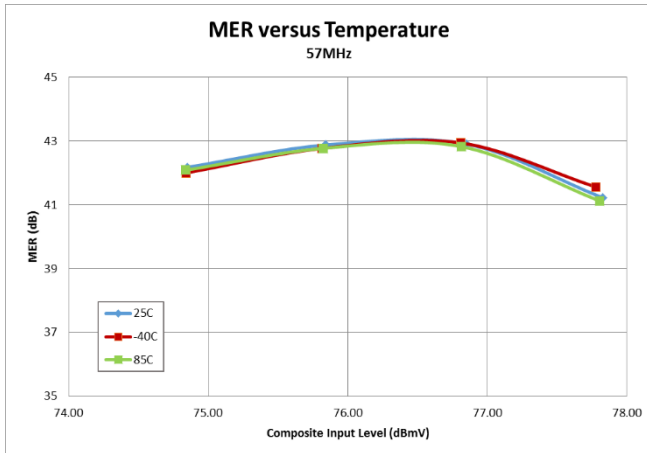

MER/CCN Test Conditions:

- 190 QAM256 Channels, 57-1215MHz, ITU-T J.83, Annex B
- CCN test procedure according to ANSI/SCTE 17. System BW 5.36MHz.

Pin Configuration and Description

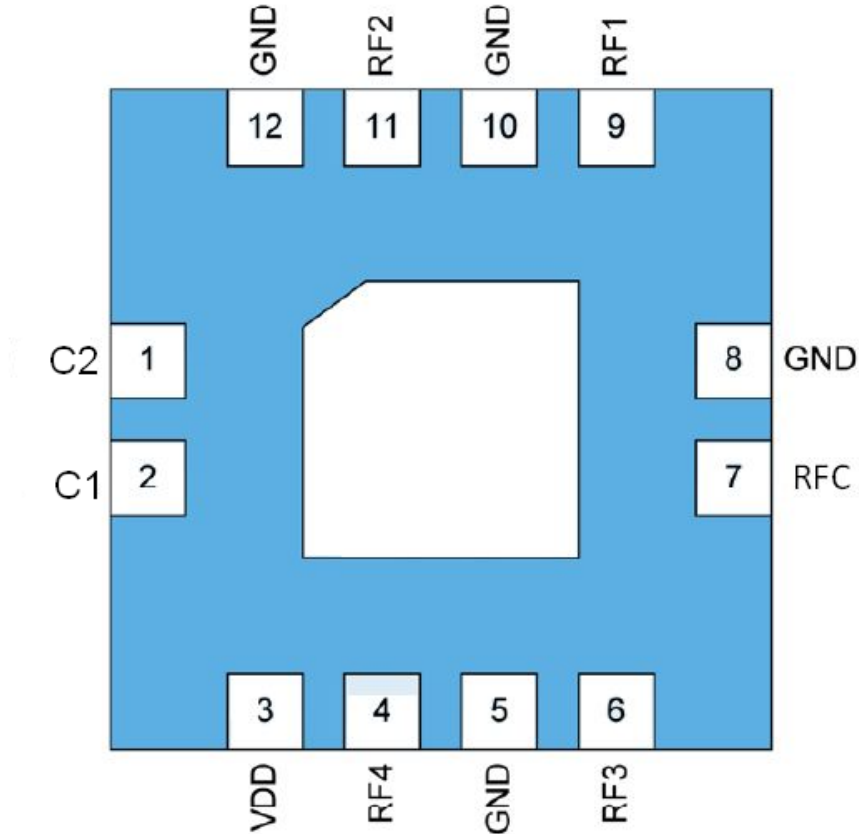

Top View

Pad No.	Label	Description
1	C2	Switch Logic Control 2
2	C1	Switch Logic Control 1
3	VDD	Supply Voltage
4	RF4	RF Output Port
5	GND	Ground
6	RF3	RF Output Port
7	RFC	RF Input Port
8	GND	Ground
9	RF1	RF Output Port
10	GND	Ground
11	RF2	RF Output Port
12	GND	Ground

Applications Schematic; 5-2000MHz

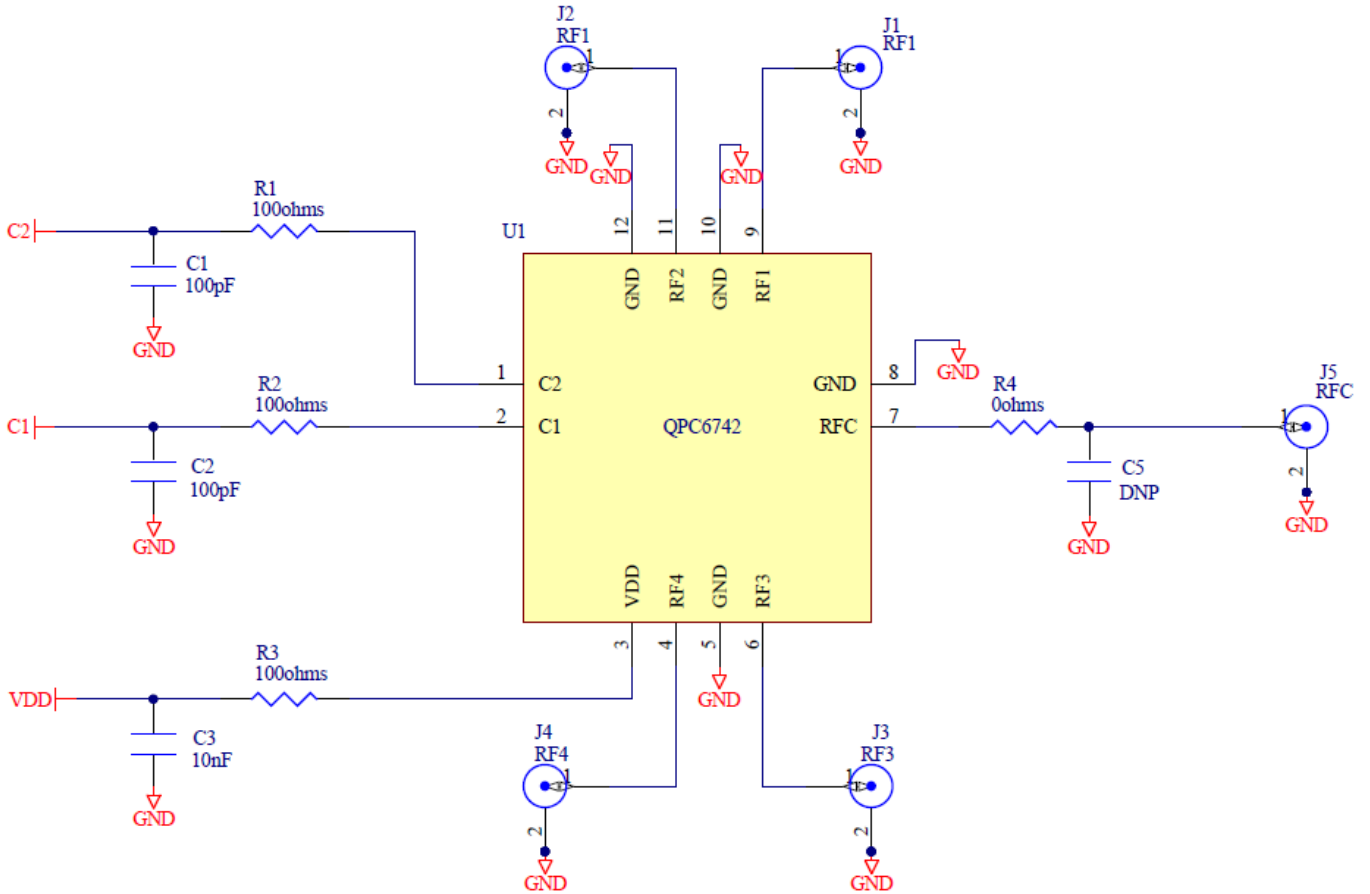

Notes:

1. R1-R3 optional for spurious or RFI suppression.
2. Isolation can be optimized by maximizing ground between RF Ports
3. R4, C5 optional for improving return loss at high frequencies (use small inductance in place of R4).

Package Dimensions

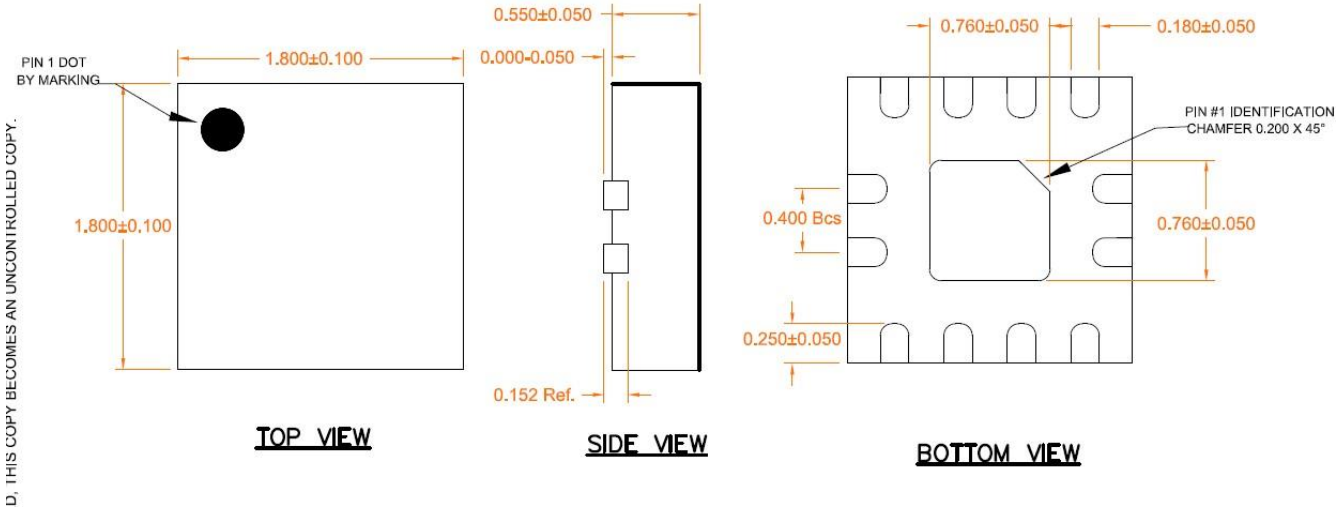

Notes:

1. All dimensions are in millimeters. Angles are in degrees.
2. The terminal #1 identifier and terminal numbering conform to JESD 95-1 SPP-012.
3. Contact plating: Matte Sn

Package Marking

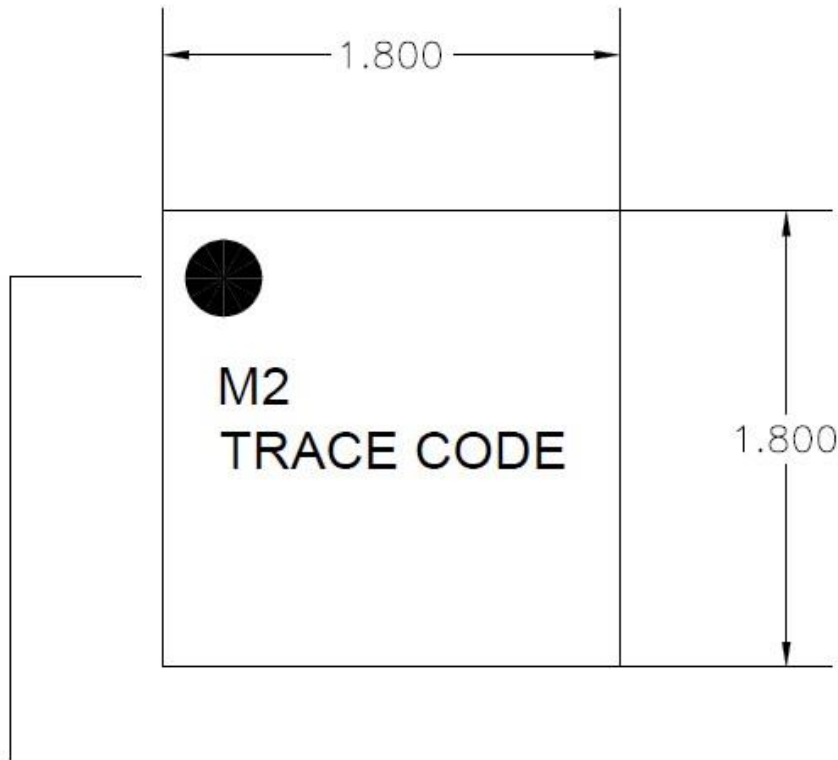

Pin 1 Indicator

Trace Code to be assigned by SubCon

Handling Precautions

Parameter	Rating	Standard
ESD – Human Body Model (HBM)	Class 2 (2000V)	ANSI/ESD/JEDEC JS-001-2010
ESD – Charged Device Model (CDM)	Class C3 (1000V)	JESD22-C101
MSL – Moisture Sensitivity Level	MSL2	JEDEC J-STD-020



Caution!
ESD-Sensitive Device

Solderability

Compatible with both lead-free (260°C max. reflow temp.) and tin/lead (245°C max. reflow temp.) soldering processes. Solder profiles available upon request.

Contact plating: Matte Sn

RoHS Compliance

This part is compliant with EU 2002/95/EC RoHS directive (Restrictions on the Use of Certain Hazardous Substances in Electrical and Electronic Equipment). This product also has the following attributes:

- Lead Free
- Halogen Free (Chlorine, Bromine)
- Antimony Free
- TBBP-A (C₁₅H₁₂Br₄O₂) Free
- PFOS Free
- SVHC Free
- Qorvo Green



Contact Information

For the latest specifications, additional product information, worldwide sales and distribution locations:

Tel: 1-844-890-8163

Web: www.qorvo.com

Email: customer.support@qorvo.com

Important Notice

The information contained herein is believed to be reliable; however, Qorvo makes no warranties regarding the information contained herein and assumes no responsibility or liability whatsoever for the use of the information contained herein. All information contained herein is subject to change without notice. Customers should obtain and verify the latest relevant information before placing orders for Qorvo products. The information contained herein or any use of such information does not grant, explicitly or implicitly, to any party any patent rights, licenses, or any other intellectual property rights, whether with regard to such information itself or anything described by such information. **THIS INFORMATION DOES NOT CONSTITUTE A WARRANTY WITH RESPECT TO THE PRODUCTS DESCRIBED HEREIN, AND QORVO HEREBY DISCLAIMS ANY AND ALL WARRANTIES WITH RESPECT TO SUCH PRODUCTS WHETHER EXPRESS OR IMPLIED BY LAW, COURSE OF DEALING, COURSE OF PERFORMANCE, USAGE OF TRADE OR OTHERWISE, INCLUDING THE IMPLIED WARRANTIES OF MERCHANTABILITY AND FITNESS FOR A PARTICULAR PURPOSE.**

Without limiting the generality of the foregoing, Qorvo products are not warranted or authorized for use as critical components in medical, life-saving, or life-sustaining applications, or other applications where a failure would reasonably be expected to cause severe personal injury or death.

Copyright 2018 © Qorvo, Inc. | Qorvo is a registered trademark of Qorvo, Inc.

Компания «Океан Электроники» предлагает заключение долгосрочных отношений при поставках импортных электронных компонентов на взаимовыгодных условиях!

Наши преимущества:

- Поставка оригинальных импортных электронных компонентов напрямую с производств Америки, Европы и Азии, а так же с крупнейших складов мира;
- Широкая линейка поставок активных и пассивных импортных электронных компонентов (более 30 млн. наименований);
- Поставка сложных, дефицитных, либо снятых с производства позиций;
- Оперативные сроки поставки под заказ (от 5 рабочих дней);
- Экспресс доставка в любую точку России;
- Помощь Конструкторского Отдела и консультации квалифицированных инженеров;
- Техническая поддержка проекта, помощь в подборе аналогов, поставка прототипов;
- Поставка электронных компонентов под контролем ВП;
- Система менеджмента качества сертифицирована по Международному стандарту ISO 9001;
- При необходимости вся продукция военного и аэрокосмического назначения проходит испытания и сертификацию в лаборатории (по согласованию с заказчиком);
- Поставка специализированных компонентов военного и аэрокосмического уровня качества (Xilinx, Altera, Analog Devices, Intersil, Interpoint, Microsemi, Actel, Aeroflex, Peregrine, VPT, Syfer, Eurofarad, Texas Instruments, MS Kennedy, Miteq, Cobham, E2V, MA-COM, Hittite, Mini-Circuits, General Dynamics и др.);

Компания «Океан Электроники» является официальным дистрибьютором и эксклюзивным представителем в России одного из крупнейших производителей разъемов военного и аэрокосмического назначения «**JONHON**», а так же официальным дистрибьютором и эксклюзивным представителем в России производителя высокотехнологичных и надежных решений для передачи СВЧ сигналов «**FORSTAR**».



JONHON

«**JONHON**» (основан в 1970 г.)

Разъемы специального, военного и аэрокосмического назначения:

(Применяются в военной, авиационной, аэрокосмической, морской, железнодорожной, горно- и нефтедобывающей отраслях промышленности)

«**FORSTAR**» (основан в 1998 г.)

ВЧ соединители, коаксиальные кабели, кабельные сборки и микроволновые компоненты:

(Применяются в телекоммуникациях гражданского и специального назначения, в средствах связи, РЛС, а так же военной, авиационной и аэрокосмической отраслях промышленности).



Телефон: 8 (812) 309-75-97 (многоканальный)

Факс: 8 (812) 320-03-32

Электронная почта: ocean@oceanchips.ru

Web: <http://oceanchips.ru/>

Адрес: 198099, г. Санкт-Петербург, ул. Калинина, д. 2, корп. 4, лит. А