

CGH27030

30 W, 28V, GaN HEMT for Linear Communications ranging from VHF to 3 GHz

Cree's CGH27030 is a gallium nitride (GaN) high electron mobility transistor (HEMT) designed specifically for high efficiency, high gain and wide bandwidth capabilities, which makes the CGH27030 ideal for VHF, Comms, 3G, 4G, LTE, 2.3-2.9GHz WiMAX and BWA amplifier applications. The unmatched transistor is available in both screw-down, flange and solder-down, pill packages.

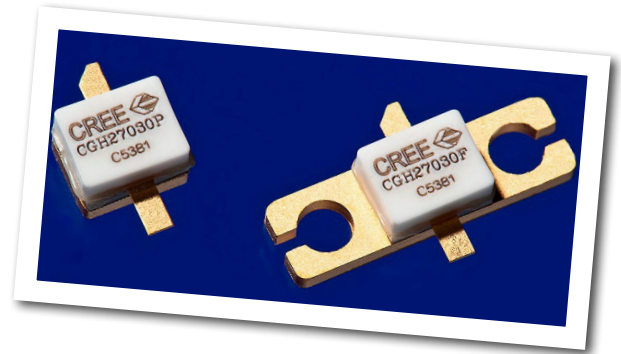

Package Type: 440196 and 440166
PN: CGH27030P and CGH27030F

Typical Performance Over 2.3-2.7GHz ($T_c = 25^\circ\text{C}$) of Demonstration Amplifier

| Parameter | 2.3 GHz | 2.4 GHz | 2.5 GHz | 2.6 GHz | 2.7 GHz | Units |
|-----------------------------------|---------|---------|---------|---------|---------|-------|
| Small Signal Gain | 15.6 | 15.5 | 15.3 | 15.1 | 15.2 | dB |
| EVM at $P_{AVE} = 36 \text{ dBm}$ | 1.73 | 1.85 | 1.85 | 1.77 | 1.43 | % |
| Drain Efficiency at 36 dBm | 28.1 | 28.7 | 28.9 | 27.9 | 27.5 | % |
| Input Return Loss | 6.6 | 6.2 | 6.0 | 6.1 | 7.0 | dB |

Note:

Measured in the CGH27030F-AMP amplifier circuit, under 802.16 OFDM, 3.5 MHz Channel BW, 1/4 Cyclic Prefix, 64 QAM Modulated Burst, 5 ms Burst, Symbol Length of 59, Coding Type RS-CC, Coding Rate Type 2/3, PAR = 9.8 dB @ 0.01 % Probability on CCDF.

Features



- VHF - 3.0 GHz Operation
- 30 W Peak Power Capability
- 15 dB Small Signal Gain
- 4.0 W P_{AVE} at < 2.0 % EVM
- 28 % Drain Efficiency at 4 W Average Power
- WiMAX Fixed Access 802.16-2004 OFDM
- WiMAX Mobile Access 802.16e OFDMA

Large Signal Models Available for ADS and MWO

Absolute Maximum Ratings (not simultaneous) at 25°C Case Temperature

| Parameter | Symbol | Rating | Units | Conditions |
|---|-----------------|-----------|-------|------------|
| Drain-Source Voltage | V_{DSS} | 84 | Volts | 25°C |
| Gate-to-Source Voltage | V_{GS} | -10, +2 | Volts | 25°C |
| Power Dissipation | P_{DISS} | 14 | Watts | |
| Storage Temperature | T_{STG} | -65, +150 | °C | |
| Operating Junction Temperature | T_J | 225 | °C | |
| Maximum Forward Gate Current | I_{GMAX} | 4.0 | mA | 25°C |
| Maximum Drain Current ¹ | I_{DMAX} | 3.0 | A | 25°C |
| Soldering Temperature ² | T_S | 245 | °C | |
| Screw Torque | τ | 60 | in-oz | |
| Thermal Resistance, Junction to Case ³ | $R_{\theta JC}$ | 4.8 | °C/W | 85°C |
| Case Operating Temperature ³ | T_C | -40, +150 | °C | |

Note:

¹ Current limit for long term, reliable operation.

² Refer to the Application Note on soldering at www.cree.com/RF/Document-Library

³ Measured for the CGH27030F at $P_{DISS} = 14\text{ W}$

Electrical Characteristics ($T_C = 25^\circ\text{C}$)

| Characteristics | Symbol | Min. | Typ. | Max. | Units | Conditions |
|--|--------------|------|------|--------|----------|--|
| DC Characteristics¹ | | | | | | |
| Gate Threshold Voltage | $V_{GS(th)}$ | -3.8 | -3.0 | -2.3 | V_{DC} | $V_{DS} = 10\text{ V}, I_D = 7.2\text{ mA}$ |
| Gate Quiescent Voltage | $V_{GS(Q)}$ | - | -2.7 | - | V_{DC} | $V_{DS} = 28\text{ V}, I_D = 150\text{ mA}$ |
| Saturated Drain Current | I_{DS} | 5.8 | 7.0 | - | A | $V_{DS} = 6.0\text{ V}, V_{GS} = 2\text{ V}$ |
| Drain-Source Breakdown Voltage | V_{BR} | 120 | - | - | V_{DC} | $V_{GS} = -8\text{ V}, I_D = 7.2\text{ mA}$ |
| RF Characteristics^{2,3} ($T_C = 25^\circ\text{C}, F_0 = 2.5\text{ GHz}$ unless otherwise noted) | | | | | | |
| Small Signal Gain | G_{SS} | 12.5 | 14.5 | - | dB | $V_{DD} = 28\text{ V}, I_{DQ} = 150\text{ mA}$ |
| Drain Efficiency ⁴ | η | 23.0 | 28.0 | - | % | $V_{DD} = 28\text{ V}, I_{DQ} = 150\text{ mA}, P_{AVE} = 4\text{ W}$ |
| Error Vector Magnitude | EVM | - | 2.0 | - | | $V_{DD} = 28\text{ V}, I_{DQ} = 150\text{ mA}, P_{AVE} = 4\text{ W}$ |
| Output Mismatch Stress | VSWR | - | - | 10 : 1 | Y | No damage at all phase angles, $V_{DD} = 28\text{ V}, I_{DQ} = 150\text{ mA}$ $P_{AVE} = 4.0\text{ W OFDM } P_{AVE}$ |
| Dynamic Characteristics⁵ | | | | | | |
| Input Capacitance | C_{GS} | - | 9.0 | - | pF | $V_{DS} = 28\text{ V}, V_{GS} = -8\text{ V}, f = 1\text{ MHz}$ |
| Output Capacitance | C_{DS} | - | 2.6 | - | pF | $V_{DS} = 28\text{ V}, V_{GS} = -8\text{ V}, f = 1\text{ MHz}$ |
| Feedback Capacitance | C_{GD} | - | 0.4 | - | pF | $V_{DS} = 28\text{ V}, V_{GS} = -8\text{ V}, f = 1\text{ MHz}$ |

Notes:

¹ Measured on wafer prior to packaging.

² Measured in the CGH27030F-AMP test fixture.

³ Under 802.16 OFDM, 3.5 MHz Channel BW, 1/4 Cyclic Prefix, 64 QAM Modulated Burst, 5 ms Burst, Symbol Length of 59, Coding Type RS-CC, Coding Rate Type 2/3, PAR = 9.8 dB @ 0.01 % Probability on CCDF.

⁴ Drain Efficiency = P_{out} / P_{DC} .

⁵ Capacitance values include package parasitics.

Typical WiMAX Performance

Small Signal S-Parameters vs Frequency measured in CGH27030F-AMP
 $V_{DD} = 28\text{ V}$, $I_{DQ} = 150\text{ mA}$

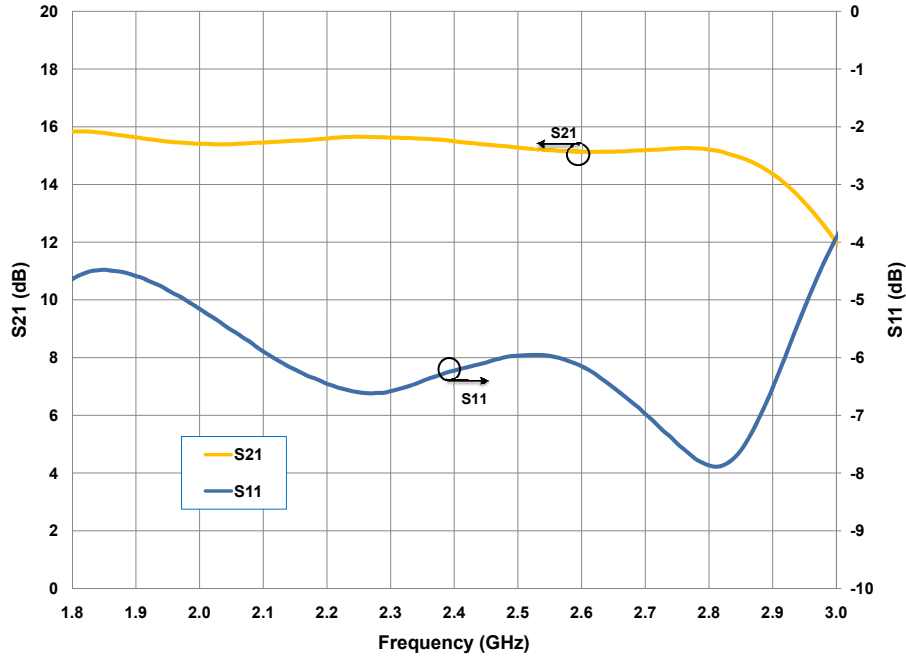

Typical EVM and Efficiency versus Frequency measured in CGH27030F-AMP
 $V_{DD} = 28\text{ V}$, $I_{DQ} = 150\text{ mA}$, 802.16-2004 OFDM, PAR=9.8 dB, $P_{AVE} = 5\text{ W}$

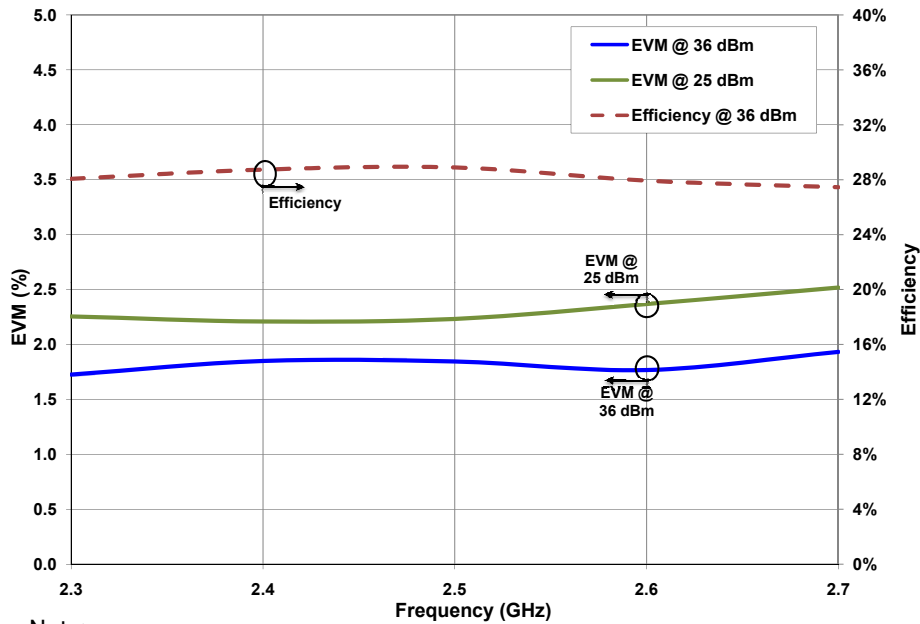

Note:

Under 802.16 OFDM, 3.5 MHz Channel BW, 1/4 Cyclic Prefix, 64 QAM Modulated Burst, Symbol Length of 59, Coding Type RS-CC, Coding Rate Type 2/3, PAR = 9.8 dB @ 0.01 % Probability on CCDF.

Typical WiMAX Performance

Drain Efficiency and EVM vs Output Power measured in CGH27030F-AMP
 $V_{DD} = 28\text{ V}$, $I_{DQ} = 150\text{ mA}$, 802.16-2004 OFDM, PAR = 9.8 dB

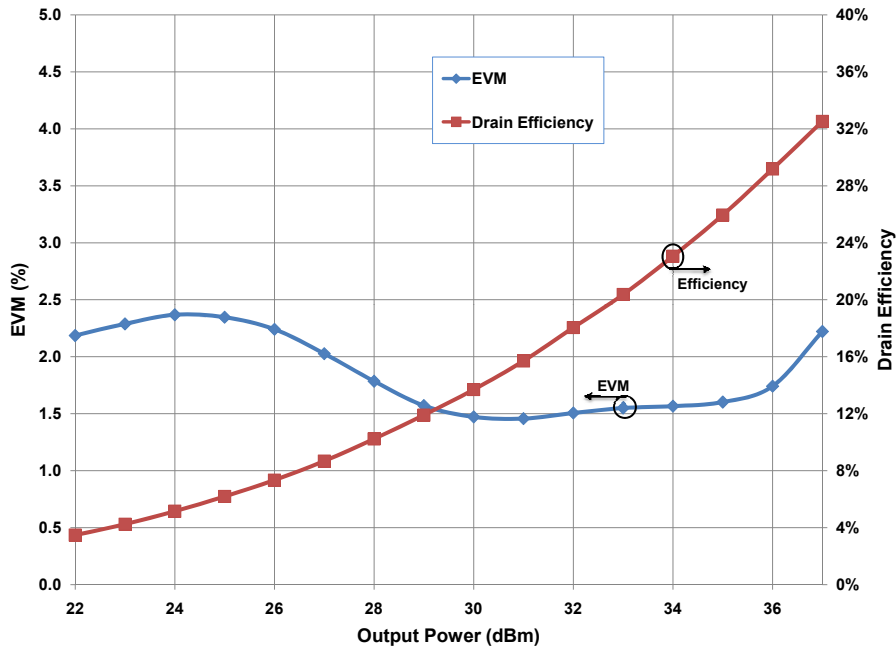

Typical Gain and Efficiency versus Output Power measured in CGH27030F-AMP
 $V_{DD} = 28\text{ V}$, $I_{DQ} = 150\text{ mA}$, 802.16-2004 OFDM, PAR=9.8 dB

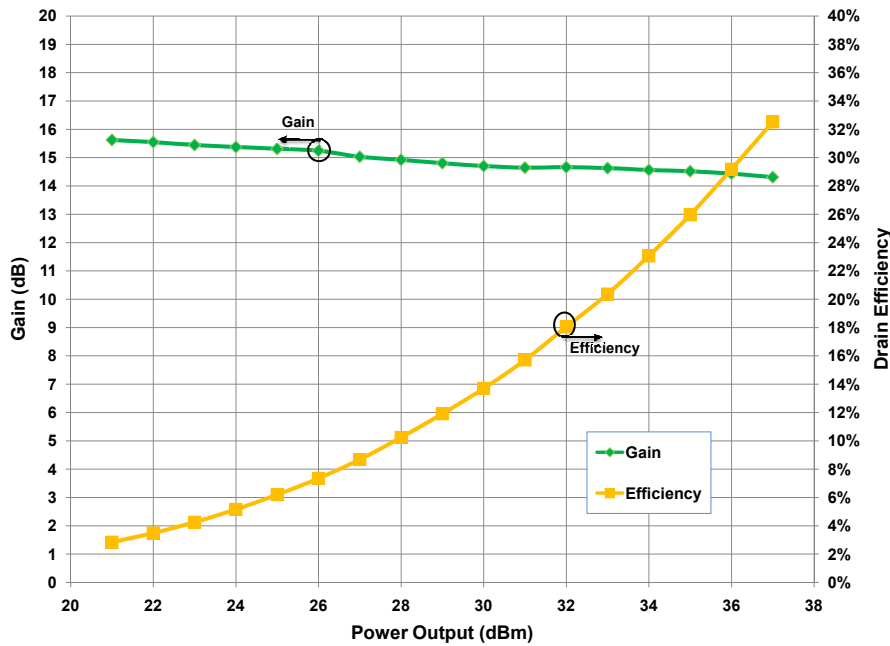

Note:

Under 802.16 OFDM, 3.5 MHz Channel BW, 1/4 Cyclic Prefix, 64 QAM Modulated Burst, Symbol Length of 59, Coding Type RS-CC, Coding Rate Type 2/3, PAR = 9.8 dB @ 0.01 % Probability on CCDF.

Typical Performance Data

Simulated Maximum Available Gain and K Factor of the CGH27030F
 $V_{DD} = 28\text{ V}, I_{DQ} = 150\text{ mA}$

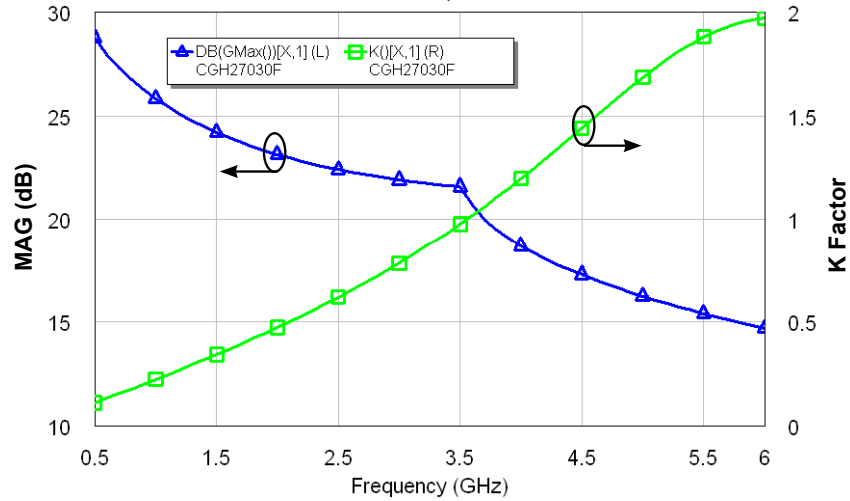

Typical Noise Performance

Simulated Minimum Noise Figure and Noise Resistance vs Frequency of the CGH27030
 $V_{DD} = 28\text{ V}, I_{DQ} = 150\text{ mA}$

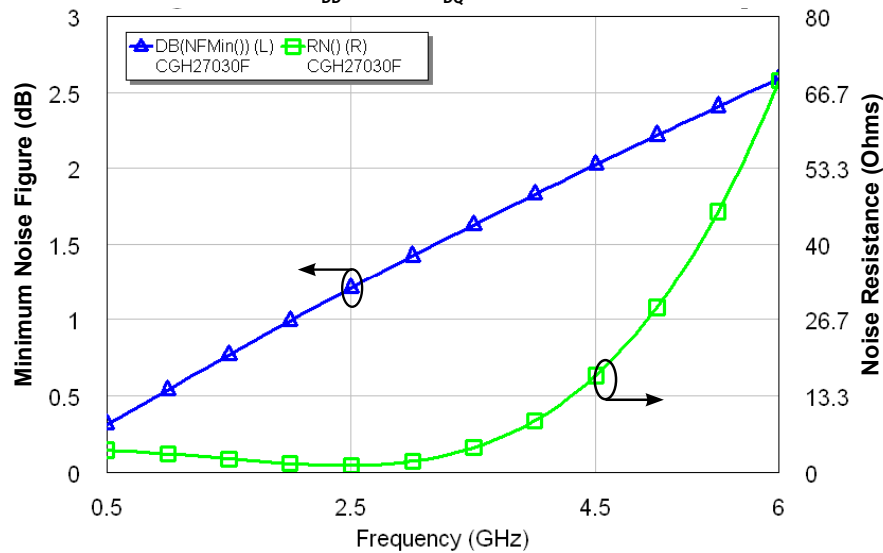

Electrostatic Discharge (ESD) Classifications

| Parameter | Symbol | Class | Test Methodology |
|---------------------|--------|------------------|---------------------|
| Human Body Model | HBM | 1A (> 250 V) | JEDEC JESD22 A114-D |
| Charge Device Model | CDM | II (200 < 500 V) | JEDEC JESD22 C101-C |

Source and Load Impedances

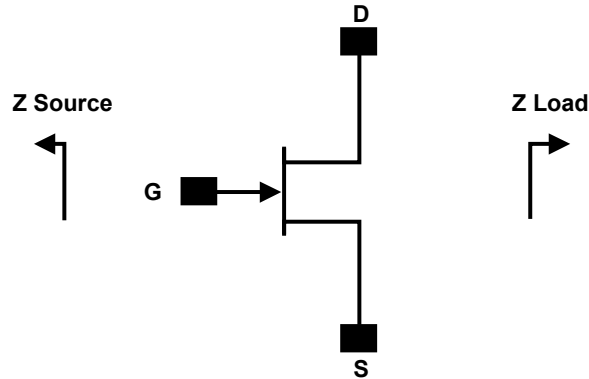

| Frequency (MHz) | Z Source | Z Load |
|-----------------|--------------|--------------|
| 500 | 7.75 + j15.5 | 20 + j5.2 |
| 1000 | 3.11 + j5.72 | 17 + j6.66 |
| 1500 | 2.86 + j1.63 | 16.8 + j3.2 |
| 2500 | 1.2 - j3.26 | 9.41 + j3.2 |
| 3500 | 1.31 - j7.3 | 5.85 - j0.51 |

Note 1. $V_{DD} = 28V$, $I_{DQ} = 250mA$ in the 440166 package.

Note 2. Optimized for power gain, P_{SAT} and PAE.

Note 3. When using this device at low frequency, series resistors should be used to maintain amplifier stability.

CGH27030 Power Dissipation De-rating Curve

CGH27030 Average Power Dissipation De-rating Curve

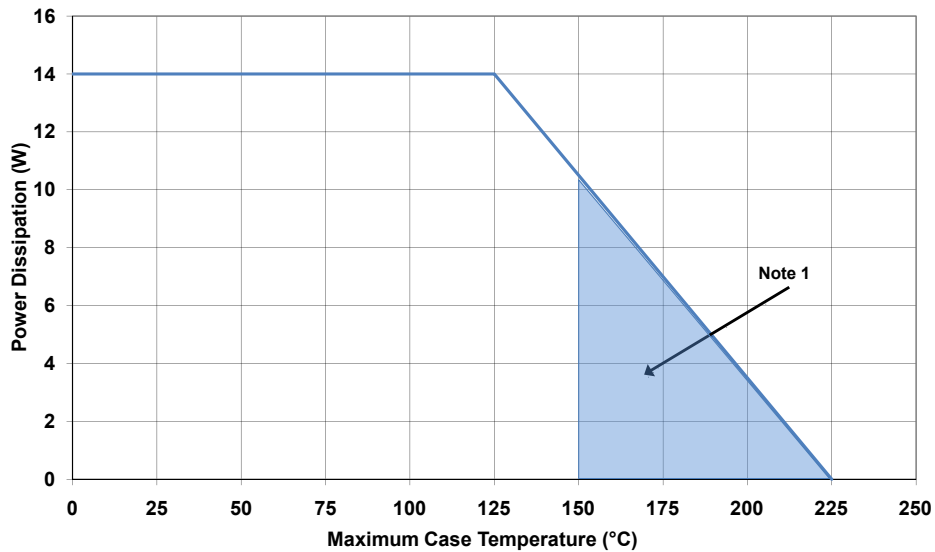

Note 1. Area exceeds Maximum Case Operating Temperature (See Page 2).

CGH27030F-AMP Demonstration Amplifier Circuit Bill of Materials

| Designator | Description | Qty |
|------------|-------------------------------------|-----|
| R1 | RES,1/16W,0603,1%,100 OHMS | 1 |
| R2 | RES,1/16W,0603,1%,47 OHMS | 1 |
| C5 | CAP, 470PF, 5%,100V, 0603 | 1 |
| C15 | CAP, 33 UF, 20%, G CASE | 1 |
| C14 | CAP, 1.0UF, 100V, 10%, X7R, 1210 | 1 |
| C7 | CAP 10UF 16V TANTALUM | 1 |
| C12 | CAP, 100.0pF, +/-5%, 0603 | 1 |
| C1 | CAP, 1.6pF, +/-0.1pF, 0603 | 1 |
| C2 | CAP, 1.8pF, +/-0.1pF, 0603 | 1 |
| C3,C10 | CAP, 10.0pF,+/-5%, 0603 | 2 |
| C4,C11 | CAP, 39pF, +/-5%, 0603 | 2 |
| C8,C9 | CAP, 3.0pF, +/-0.1pF, 0603 | 2 |
| C6,C13 | CAP,33000PF, 0805,100V, X7R | 2 |
| J3,J4 | CONN SMA STR PANEL JACK RECP | 1 |
| J2 | HEADER RT>PLZ.1CEN LK 2 POS | 1 |
| J1 | HEADER RT>PLZ. .1CEN LK 5POS | 1 |
| - | PCB, RO4350B, Er = 3.48, h = 20 mil | 1 |
| - | CGH27030F | 1 |

CGH27030F-AMP Demonstration Amplifier Circuit

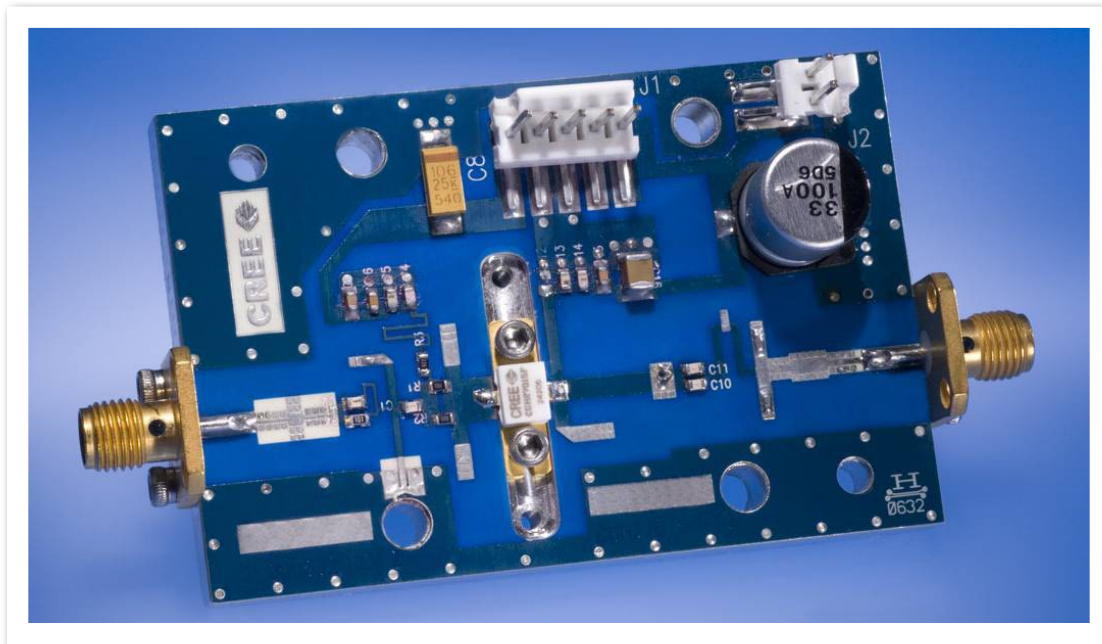

CGH27030F-AMP Demonstration Amplifier Circuit Schematic

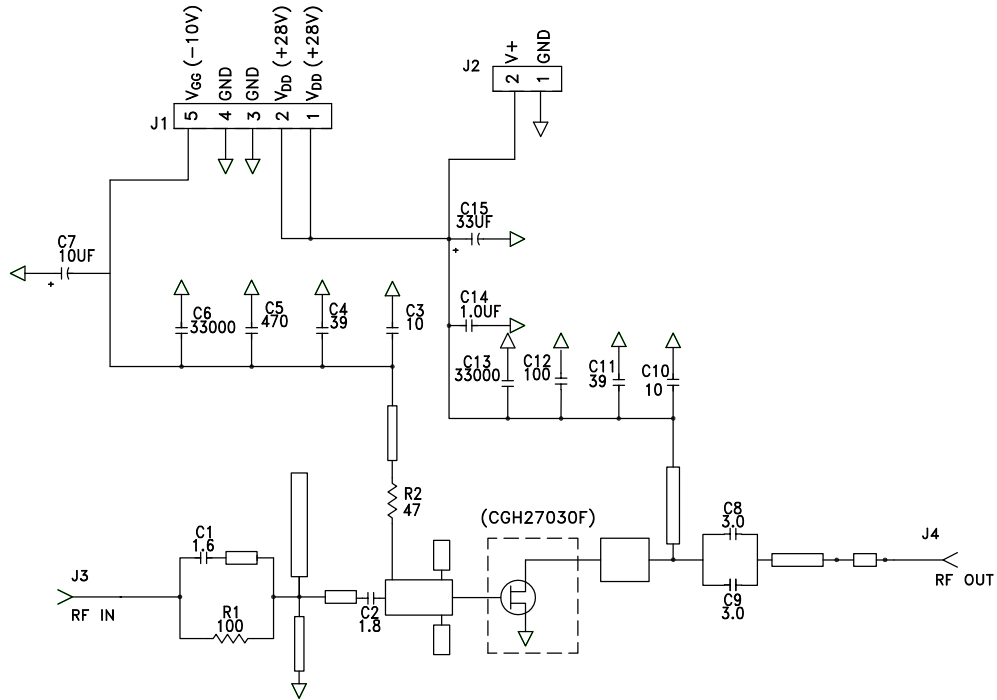

CGH27030F-AMP Demonstration Amplifier Circuit Outline

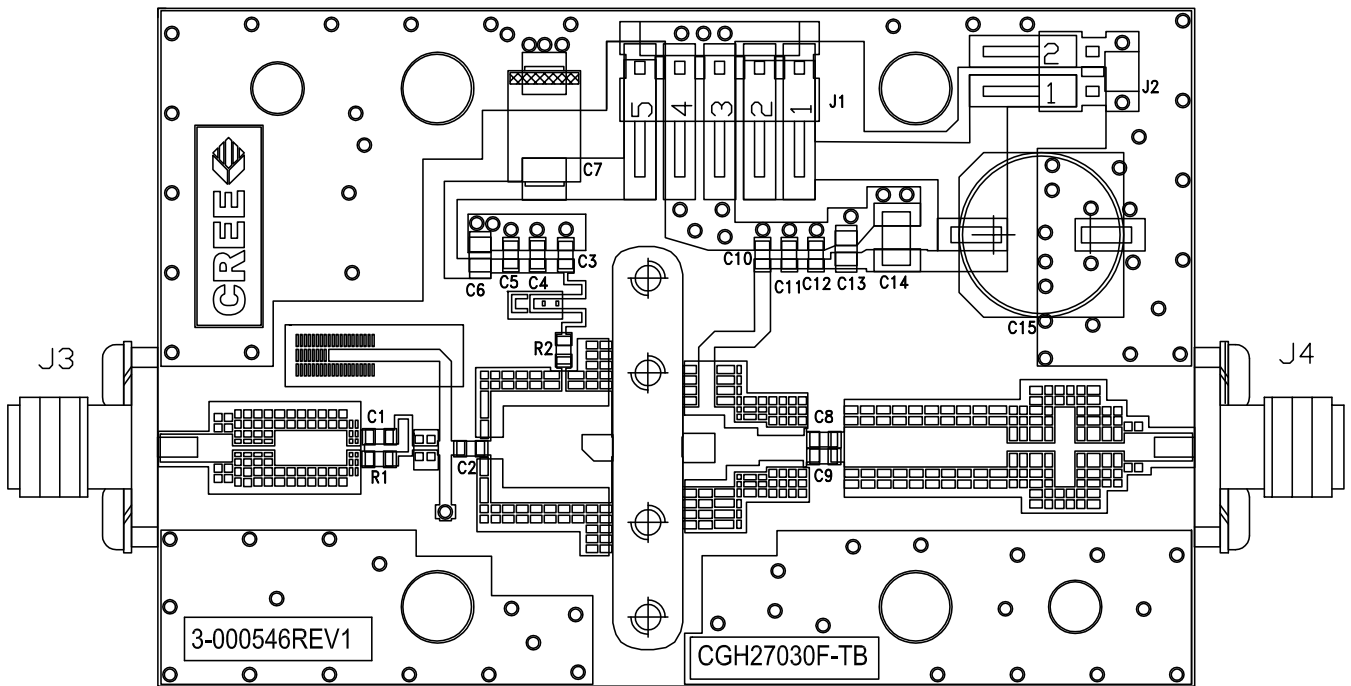

Typical Package S-Parameters for CGH27030
 (Small Signal, $V_{DS} = 28\text{ V}$, $I_{DQ} = 150\text{ mA}$, angle in degrees)

| Frequency | Mag S11 | Ang S11 | Mag S21 | Ang S21 | Mag S12 | Ang S12 | Mag S22 | Ang S22 |
|-----------|---------|---------|---------|---------|---------|---------|---------|---------|
| 500 MHz | 0.910 | -127.91 | 18.04 | 106.46 | 0.024 | 20.12 | 0.314 | -103.83 |
| 600 MHz | 0.904 | -137.21 | 15.52 | 100.35 | 0.025 | 14.75 | 0.306 | -111.67 |
| 700 MHz | 0.900 | -144.50 | 13.58 | 95.23 | 0.025 | 10.38 | 0.302 | -117.66 |
| 800 MHz | 0.897 | -150.40 | 12.04 | 90.78 | 0.025 | 6.69 | 0.302 | -122.33 |
| 900 MHz | 0.895 | -155.33 | 10.80 | 86.81 | 0.026 | 3.48 | 0.303 | -126.06 |
| 1.0 GHz | 0.894 | -159.54 | 9.78 | 83.20 | 0.026 | 0.63 | 0.306 | -129.12 |
| 1.1 GHz | 0.893 | -163.21 | 8.93 | 79.85 | 0.026 | -1.95 | 0.310 | -131.69 |
| 1.2 GHz | 0.892 | -166.46 | 8.22 | 76.69 | 0.025 | -4.31 | 0.315 | -133.89 |
| 1.3 GHz | 0.891 | -169.40 | 7.60 | 73.70 | 0.025 | -6.51 | 0.321 | -135.84 |
| 1.4 GHz | 0.891 | -172.09 | 7.07 | 70.84 | 0.025 | -8.56 | 0.327 | -137.59 |
| 1.5 GHz | 0.891 | -174.57 | 6.61 | 68.08 | 0.025 | -10.50 | 0.334 | -139.20 |
| 1.6 GHz | 0.891 | -176.88 | 6.20 | 65.41 | 0.025 | -12.34 | 0.341 | -140.70 |
| 1.7 GHz | 0.891 | -179.07 | 5.84 | 62.81 | 0.025 | -14.09 | 0.348 | -142.13 |
| 1.8 GHz | 0.891 | 178.86 | 5.52 | 60.28 | 0.025 | -15.76 | 0.355 | -143.51 |
| 1.9 GHz | 0.891 | 176.88 | 5.23 | 57.79 | 0.024 | -17.36 | 0.362 | -144.85 |
| 2.0 GHz | 0.891 | 174.98 | 4.96 | 55.35 | 0.024 | -18.90 | 0.370 | -146.16 |
| 2.1 GHz | 0.891 | 173.13 | 4.73 | 52.95 | 0.024 | -20.38 | 0.378 | -147.46 |
| 2.2 GHz | 0.892 | 171.34 | 4.51 | 50.59 | 0.024 | -21.80 | 0.385 | -148.75 |
| 2.3 GHz | 0.892 | 169.60 | 4.32 | 48.25 | 0.023 | -23.16 | 0.393 | -150.03 |
| 2.4 GHz | 0.892 | 167.89 | 4.14 | 45.95 | 0.023 | -24.48 | 0.400 | -151.32 |
| 2.5 GHz | 0.892 | 166.20 | 3.97 | 43.66 | 0.023 | -25.74 | 0.408 | -152.61 |
| 2.6 GHz | 0.893 | 164.55 | 3.82 | 41.40 | 0.023 | -26.95 | 0.415 | -153.91 |
| 2.7 GHz | 0.893 | 162.91 | 3.68 | 39.16 | 0.022 | -28.11 | 0.422 | -155.21 |
| 2.8 GHz | 0.893 | 161.28 | 3.54 | 36.93 | 0.022 | -29.22 | 0.429 | -156.52 |
| 2.9 GHz | 0.893 | 159.67 | 3.42 | 34.72 | 0.022 | -30.28 | 0.436 | -157.84 |
| 3.0 GHz | 0.894 | 158.06 | 3.31 | 32.52 | 0.021 | -31.28 | 0.443 | -159.17 |
| 3.2 GHz | 0.894 | 154.86 | 3.10 | 28.16 | 0.021 | -33.13 | 0.456 | -161.87 |
| 3.4 GHz | 0.894 | 151.65 | 2.92 | 23.83 | 0.020 | -34.76 | 0.469 | -164.62 |
| 3.6 GHz | 0.895 | 148.41 | 2.77 | 19.52 | 0.020 | -36.15 | 0.480 | -167.42 |
| 3.8 GHz | 0.895 | 145.14 | 2.63 | 15.23 | 0.019 | -37.28 | 0.491 | -170.27 |
| 4.0 GHz | 0.895 | 141.81 | 2.50 | 10.94 | 0.018 | -38.13 | 0.501 | -173.18 |
| 4.2 GHz | 0.895 | 138.42 | 2.39 | 6.64 | 0.018 | -38.69 | 0.510 | -176.16 |
| 4.4 GHz | 0.896 | 134.95 | 2.29 | 2.32 | 0.017 | -38.93 | 0.519 | -179.20 |
| 4.6 GHz | 0.896 | 131.39 | 2.20 | -2.02 | 0.017 | -38.84 | 0.526 | 177.68 |
| 4.8 GHz | 0.896 | 127.73 | 2.12 | -6.40 | 0.016 | -38.43 | 0.533 | 174.48 |
| 5.0 GHz | 0.895 | 123.96 | 2.05 | -10.82 | 0.016 | -37.69 | 0.539 | 171.19 |
| 5.2 GHz | 0.895 | 120.07 | 1.99 | -15.29 | 0.016 | -36.68 | 0.545 | 167.80 |
| 5.4 GHz | 0.895 | 116.05 | 1.93 | -19.83 | 0.016 | -35.43 | 0.549 | 164.31 |
| 5.6 GHz | 0.895 | 111.90 | 1.87 | -24.44 | 0.016 | -34.05 | 0.553 | 160.70 |
| 5.8 GHz | 0.895 | 107.59 | 1.82 | -29.13 | 0.016 | -32.64 | 0.556 | 156.95 |
| 6.0 GHz | 0.895 | 103.14 | 1.78 | -33.91 | 0.016 | -31.32 | 0.559 | 153.06 |

To download the s-parameters in s2p format, go to the [CGH27030 Product Page](#) and click on the documentation tab.

Product Dimensions CGH27030F (Package Type – 440166)

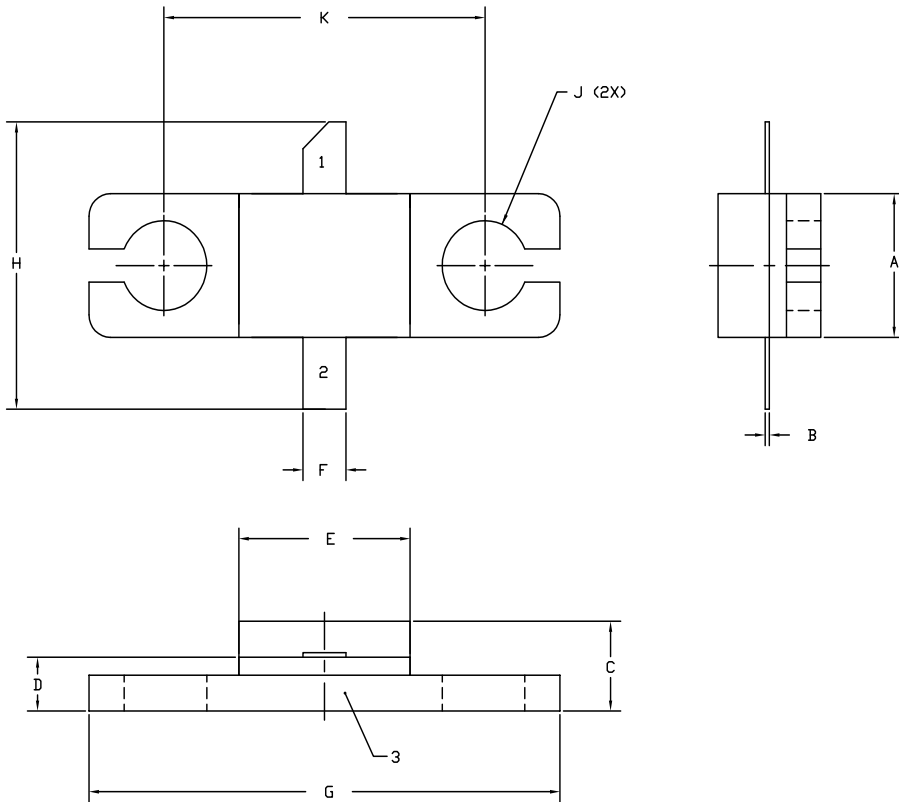

NOTES:

1. DIMENSIONING AND TOLERANCING PER ANSI Y14.5M, 1982.
2. CONTROLLING DIMENSION: INCH.
3. ADHESIVE FROM LID MAY EXTEND A MAXIMUM OF 0.020" BEYOND EDGE OF LID.
4. LID MAY BE MISALIGNED TO THE BODY OF THE PACKAGE BY A MAXIMUM OF 0.008" IN ANY DIRECTION.
5. ALL PLATED SURFACES ARE NI/AU

| DIM | INCHES | | MILLIMETERS | |
|-----|-------------|-------|-------------|-------|
| | MIN | MAX | MIN | MAX |
| A | 0.155 | 0.165 | 3.94 | 4.19 |
| B | 0.004 | 0.006 | 0.10 | 0.15 |
| C | 0.115 | 0.135 | 2.92 | 3.43 |
| D | 0.057 | 0.067 | 1.45 | 1.70 |
| E | 0.195 | 0.205 | 4.95 | 5.21 |
| F | 0.045 | 0.055 | 1.14 | 1.40 |
| G | 0.545 | 0.555 | 13.84 | 14.09 |
| H | 0.280 | 0.360 | 7.11 | 9.14 |
| J | ϕ .100 | | 2.54 | |
| K | 0.375 | | 9.53 | |

- PIN 1. GATE
 PIN 2. DRAIN
 PIN 3. SOURCE

Product Dimensions CGH27030P (Package Type – 440196)

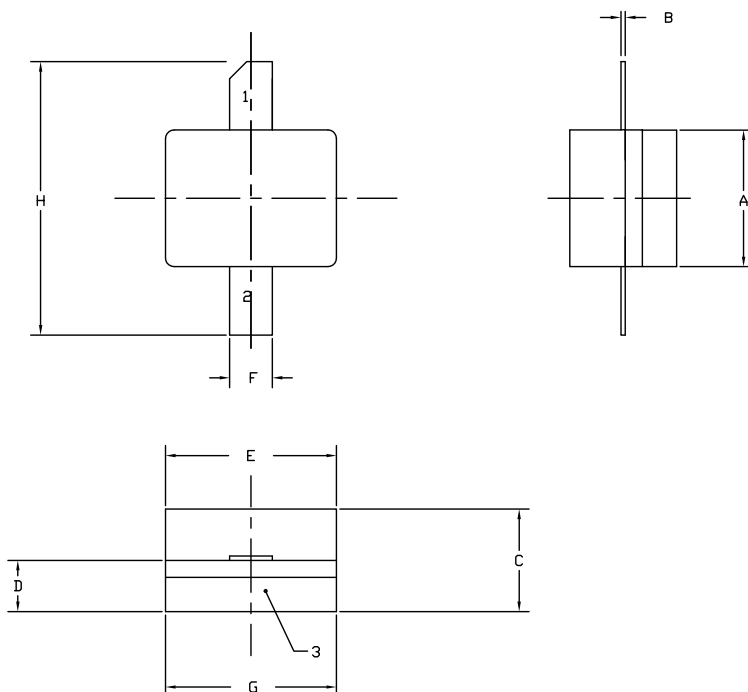



NOTES:

1. DIMENSIONING AND TOLERANCING PER ANSI Y14.5M, 1982.
2. CONTROLLING DIMENSION: INCH.
3. ADHESIVE FROM LID MAY EXTEND A MAXIMUM OF 0.020" BEYOND EDGE OF LID.
4. LID MAY BE MISALIGNED TO THE BODY OF THE PACKAGE BY A MAXIMUM OF 0.008" IN ANY DIRECTION.
5. ALL PLATED SURFACES ARE NI/AU

| DIM | INCHES | | MILLIMETERS | |
|-----|--------|-------|-------------|------|
| | MIN | MAX | MIN | MAX |
| A | 0.155 | 0.165 | 3.94 | 4.19 |
| B | 0.003 | 0.006 | 0.10 | 0.15 |
| C | 0.115 | 0.135 | 2.92 | 3.17 |
| D | 0.057 | 0.067 | 1.45 | 1.70 |
| E | 0.195 | 0.205 | 4.95 | 5.21 |
| F | 0.045 | 0.055 | 1.14 | 1.40 |
| G | 0.195 | 0.205 | 4.95 | 5.21 |
| H | 0.280 | 0.360 | 7.11 | 9.14 |

- PIN 1. GATE
 PIN 2. DRAIN
 PIN 3. SOURCE

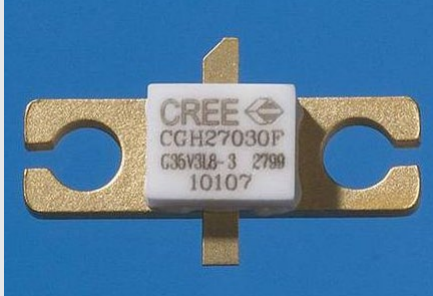
Product Ordering Information

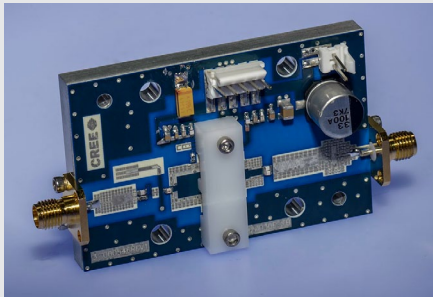
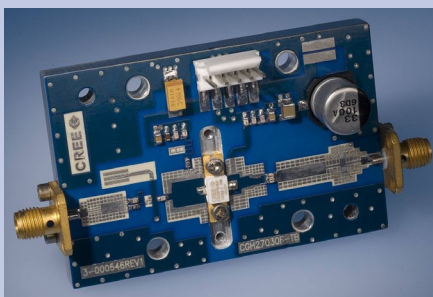
| Order Number | Description | Unit of Measure | Image |
|---------------|------------------------------------|-----------------|---|
| CGH27030F | GaN HEMT | Each |  |
| CGH27030P | GaN HEMT | Each |  |
| CGH27030F-TB | Test board without GaN HEMT | Each |  |
| CGH27030F-AMP | Test board with GaN HEMT installed | Each |  |



Disclaimer

Specifications are subject to change without notice. Cree, Inc. believes the information contained within this data sheet to be accurate and reliable. However, no responsibility is assumed by Cree for any infringement of patents or other rights of third parties which may result from its use. No license is granted by implication or otherwise under any patent or patent rights of Cree. Cree makes no warranty, representation or guarantee regarding the suitability of its products for any particular purpose. "Typical" parameters are the average values expected by Cree in large quantities and are provided for information purposes only. These values can and do vary in different applications and actual performance can vary over time. All operating parameters should be validated by customer's technical experts for each application. Cree products are not designed, intended or authorized for use as components in applications intended for surgical implant into the body or to support or sustain life, in applications in which the failure of the Cree product could result in personal injury or death or in applications for planning, construction, maintenance or direct operation of a nuclear facility.

For more information, please contact:

Cree, Inc.
4600 Silicon Drive
Durham, North Carolina, USA 27703
www.cree.com/RF

Sarah Miller
Marketing
Cree, RF Components
1.919.407.5302

Ryan Baker
Marketing & Sales
Cree, RF Components
1.919.407.7816

Tom Dekker
Sales Director
Cree, RF Components
1.919.407.5639

Компания «Океан Электроники» предлагает заключение долгосрочных отношений при поставках импортных электронных компонентов на взаимовыгодных условиях!

Наши преимущества:

- Поставка оригинальных импортных электронных компонентов напрямую с производств Америки, Европы и Азии, а так же с крупнейших складов мира;
- Широкая линейка поставок активных и пассивных импортных электронных компонентов (более 30 млн. наименований);
- Поставка сложных, дефицитных, либо снятых с производства позиций;
- Оперативные сроки поставки под заказ (от 5 рабочих дней);
- Экспресс доставка в любую точку России;
- Помощь Конструкторского Отдела и консультации квалифицированных инженеров;
- Техническая поддержка проекта, помощь в подборе аналогов, поставка прототипов;
- Поставка электронных компонентов под контролем ВП;
- Система менеджмента качества сертифицирована по Международному стандарту ISO 9001;
- При необходимости вся продукция военного и аэрокосмического назначения проходит испытания и сертификацию в лаборатории (по согласованию с заказчиком);
- Поставка специализированных компонентов военного и аэрокосмического уровня качества (Xilinx, Altera, Analog Devices, Intersil, Interpoint, Microsemi, Actel, Aeroflex, Peregrine, VPT, Syfer, Eurofarad, Texas Instruments, MS Kennedy, Miteq, Cobham, E2V, MA-COM, Hittite, Mini-Circuits, General Dynamics и др.);

Компания «Океан Электроники» является официальным дистрибьютором и эксклюзивным представителем в России одного из крупнейших производителей разъемов военного и аэрокосмического назначения «JONHON», а так же официальным дистрибьютором и эксклюзивным представителем в России производителя высокотехнологичных и надежных решений для передачи СВЧ сигналов «FORSTAR».



JONHON

«JONHON» (основан в 1970 г.)

Разъемы специального, военного и аэрокосмического назначения:

(Применяются в военной, авиационной, аэрокосмической, морской, железнодорожной, горно- и нефтедобывающей отраслях промышленности)

«FORSTAR» (основан в 1998 г.)

ВЧ соединители, коаксиальные кабели,
кабельные сборки и микроволновые компоненты:

(Применяются в телекоммуникациях гражданского и специального назначения, в средствах связи, РЛС, а так же военной, авиационной и аэрокосмической отраслях промышленности).



Телефон: 8 (812) 309-75-97 (многоканальный)

Факс: 8 (812) 320-03-32

Электронная почта: ocean@oceanchips.ru

Web: <http://oceanchips.ru/>

Адрес: 198099, г. Санкт-Петербург, ул. Калинина, д. 2, корп. 4, лит. А