

- Round solution
- Designed for navigating a display or controlling a unit
- 90° R=17.5 mm; Ø14.3 mm (Ø34.25 mm)
- h =12.2 mm; 11.7 mm
- Material: ABS/polycarbonate
- Temp. Range:
  - Solid cap: -40/+65°C
  - Transparent cap: -40/+85°C
- Panel cut-out: 1ZB-R<sub>1</sub> 7,1 R<sub>2</sub> 17,5 – 17,75 90° 1ZCS-Ø14.7
- navimec™ panel cut-out: Ø35,0 - 35,5 Depending on application

All dimensions in mm

Tolerances +/-0.2mm



### DIMENSIONS

#### TH + 1ZB



#### SMD w/LED + 1ZCS

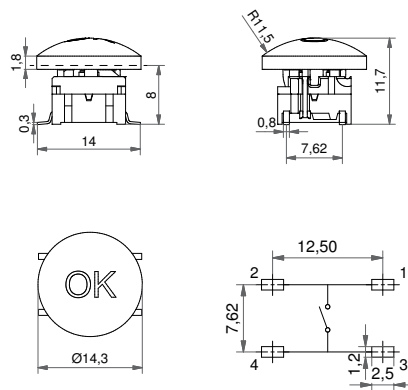

#### PCB layout for Navimec solution



We recommend using through-hole terminals for precise placing.

### ILLUMINATED – HOW TO ORDER

| Switch | Mounting                                | Actuation force      | LED  | Cap  | Legend code                        |
|--------|---|----------------------|--|--|------------------------------------|
| 5 G    | TH9 through-hole<br>(SH9 surface mount) | 20<br>35<br>65<br>Q* | 02 blue<br>22 green<br>42 yellow<br>61 white<br>82 red<br>2242 green/yellow<br>8222 red/green<br>8242 red/yellow | 1 Z B 1 6<br>Frosted white with black hard paint and laser marking | DLMH136 ▲<br>LMH118 OK<br>LMH123 ⏻ |

\*For an illuminated quiet 2.0N switch add Q to the end of the switch part number.

### NON-ILLUMINATED – HOW TO ORDER

| Switch | Mounting                                | Actuation force       | Cap              | Colour code   | Legend code**  |
|--------|---|-----------------------|------------------|---|--|
| 5 G    | TH9 through-hole<br>(SH9 surface mount) | 20<br>20Q<br>35<br>65 | 1 Z B<br>1 Z C S | 03 grey<br>06 white<br>09 black<br>30 ultra blue<br>40 dusty blue<br>42 aqua blue | D136 ▲<br>038 RESET<br>105 ENTER<br>118 OK<br>119 SET<br>120 MENU<br>121 FUNC<br>122 HOME<br>123 ⏻ |

\*\* White legends on black caps are standard, other options are available but considered custom products. See pages 34-35 or www.mec.dk

Ordering example: 4x 5GTH93561+1ZB16DLMH13609 + 1x 5GTH93561+1ZCS16LMH12309 (with illumination) OR 4x 5GSH920+1ZB09 + 1x 5GSH920+1ZCS09 (without illumination) OR \*5GTH92002Q (Illuminated quiet version)

Please see colour codes, updates of products and changes of specifications on www.mec.dk

# Legends

Available for Multimec caps

standard legends

| LEGEND | 1B09U_<br>1B09D_ | 1DS09_ | 1FS096R_ | 1ZB09D_<br>1ZB16DLMH_ | 1ZCS_ | 10R_ & 10RF_<br>10RM16_ | 10Q_<br>10QM16_ |
|--------|------------------|--------|----------|-----------------------|-------|-------------------------|-----------------|
| 0      | 000              | 000    | 000      |                       |       |                         |                 |
| 1      | 001              | 001    | 001      |                       |       |                         |                 |
| 2      | 002              | 002    | 002      |                       |       |                         |                 |
| 3      | 003              | 003    | 003      |                       |       |                         |                 |
| 4      | 004              | 004    | 004      |                       |       |                         |                 |
| 5      | 005              | 005    | 005      |                       |       |                         |                 |
| 6      | 006              | 006    | 006      |                       |       |                         |                 |
| 7      | 007              | 007    | 007      |                       |       |                         |                 |
| 8      | 008              | 008    | 008      |                       |       |                         |                 |
| 9      | 009              | 009    | 009      |                       |       |                         |                 |
| #      |                  | 107    | 107      |                       |       |                         |                 |
| *      |                  | 019    | 019      |                       |       |                         |                 |
| →      |                  | 033    |          |                       |       |                         |                 |
| ←      |                  | 133    |          |                       |       |                         |                 |
| ↑      |                  | 034    |          |                       |       |                         |                 |
| ↓      |                  | 134    |          |                       |       |                         |                 |
| ↶      |                  | 135    | 135      |                       |       |                         |                 |
| +      |                  |        |          |                       |       | 054                     | 054             |
| -      |                  |        |          |                       |       | 059                     | 059             |
| ▲      |                  |        |          | 136*                  |       |                         |                 |
| ⏻      |                  | 123    | 123      |                       | 123*  | 123                     | 123             |
| ON/OFF |                  |        |          |                       |       | 017                     | 017             |
| STOP   |                  |        |          |                       |       | 018                     | 018             |
| START  |                  |        |          |                       |       | 031                     | 031             |
| RESET  |                  |        |          |                       | 038   | 038                     | 038             |
| CANCEL |                  |        |          |                       |       | 048                     | 048             |
| ENTER  |                  |        |          |                       | 105   | 105                     | 105             |
| ESC    |                  |        |          |                       | 051   |                         |                 |
| OK     |                  |        |          |                       | 118*  | 118                     | 118             |
| SET    |                  |        |          |                       | 119   |                         |                 |
| MENU   |                  |        |          |                       | 120   |                         |                 |
| FUNC   |                  |        |          |                       | 121   |                         |                 |
| HOME   |                  |        |          |                       | 122   |                         |                 |

## STANDARD OPTIONS

1B  
pad printed

1DS  
pad printed

1FS  
reverse printed

1ZB  
pad printed  
\*laser marked

1ZCS  
pad printed  
\*reverse printed  
\*laser marked

10R(F) & 10Q  
pad printed  
reverse printed

10RM & 10QM  
metal symbol

# Legends

Available for Multimec caps

how to order



## POSITIONING OF LEGENDS ON ROCKER-ACTION CAPS

When ordering legends for caps with hinge-type cap retention system, it is important to note the position of the cap. An extra letter (U or D) needs to be added to the part number to refer to the position of the hinges in relation to the legend. See samples to the left.

Rocker-action caps without a lens: 1A, 1B, 1M, 1ZA and 1ZB

Orientation of the switch:



## LEGEND ILLUMINATION

Option 1: LASER MARKED

In case of laser marked legends an "LM" is added after the cap colour, before the legend code. We recommend using hard paint (additional "H" ) for increased lifetime of the paint. E.g. 1ZB16DLMH13609

Option 2: REVERSE PRINTED

In case of reverse printed caps an "R" is added after the cap colour, before the legend code. Especially relevant when standard legends has both negative and positive print option. E.g. 1FS096R00009

Option 3: METAL SYMBOL

Only available for 10RM and 10QM (therefore the "M"). E.g. 10RM16059

## STANDARD AND CUSTOM LEGENDS - HOW TO ORDER

### STANDARD LEGENDS

- Standard are only certain legends on certain caps. See the table on the previous page.
- All standard pad-printed legends are white on black caps.
- All standard reverse-printed and laser marked legends are black on frosted white cap.

| Cap        | Cap colour              | Direction*                | Type*                                 | Legend       | Legend colour*   |
|------------|-------------------------|---------------------------|---------------------------------------|--------------|------------------|
| □□□□       | □□                      | □□                        | □□□□                                  | □□□□         | □□               |
| <b>1B</b>  | <b>00</b> blue          | <b>D</b> down             | <b>LM</b> laser marked on soft paint  | <b>001</b> 1 | <b>00</b> blue   |
| <b>1DS</b> | <b>02</b> green         | <b>U</b> up               | <b>LMH</b> laser marked on hard paint | <b>002</b> 2 | <b>02</b> green  |
| ... etc    | <b>03</b> grey          |                           | <b>R</b> reverse printed              | <b>003</b> 3 | <b>03</b> grey   |
|            | <b>04</b> yellow        | *only for hinge-type caps | *in case of illumination              | ... etc      | <b>04</b> yellow |
|            | <b>06</b> white         |                           |                                       |              | <b>06</b> white  |
|            | <b>08</b> red           |                           |                                       |              | <b>08</b> red    |
|            | <b>09</b> black         |                           |                                       |              | <b>09</b> black  |
|            | <b>16</b> frosted white |                           |                                       |              | ... etc          |
|            | ... etc                 |                           |                                       |              |                  |

\*in case of laser marked legends the colour of the soft or hard paint

## NOTE:

- The size of the legends listed may not correspond to the actual size.
- If you decide to use one of the standard legends without any adjustments (without a new cliché) on another cap than designated in the table, then there is no start-up cost, for this to apply the cap has to be black and the print white.
- Standard legend colours are white paint on a black cap and black paint on a frosted white cap. Other colour combinations are handled as custom.
- For further information on legends please contact your local distributor or MEC.

PLEASE FIND THE FULL LIST OF AVAILABLE LEGENDS ON MEC WEBSITE [www.mec.dk](http://www.mec.dk)

Ordering example: 1ZW0913611806; 1B06U13508; 10R16R10509

Please see colour codes, updates of products and changes of specifications on [www.mec.dk](http://www.mec.dk)

|          |      |   |       |   |      |   |        |   |       |   |      |   |       |   |
|----------|------|---|-------|---|------|---|--------|---|-------|---|------|---|-------|---|
| No.      | 00   |  | 02    |  | 03   |  | 04     |  | 06    |  | 08   |  | 09    |  |
| Colour   | blue |   | green |   | grey |   | yellow |   | white |   | red  |   | black |   |
| RAL Code | 5012 |   | 6018  |   | 7004 |   | 1023   |   | 9010  |   | 3000 |   | 9004  |   |

|          |            |   |            |   |           |   |       |   |           |   |            |   |           |   |
|----------|------------|---|------------|---|-----------|---|-------|---|-----------|---|------------|---|-----------|---|
| No.      | 30         |  | 32         |  | 33        |  | 34    |  | 38        |  | 40         |  | 42        |  |
| Colour   | ultra blue |   | mint green |   | tele grey |   | melon |   | noble red |   | dusty blue |   | aqua blue |   |
| RAL Code | 5002       |   | 6029       |   | 7046      |   | 1028  |   | 3002      |   | 5014       |   | 5021      |   |

## Metallic Colours

|          |             |   |             |   |             |   |             |   |
|----------|-------------|---|-------------|---|-------------|---|-------------|---|
| No.      | 50          |  | 53          |  | 57          |  | 58          |  |
| Colour   | dark blue   |   | light grey  |   | dark grey   |   | bordeaux    |   |
| RAL Code | No Ral Code |   | No Ral Code |   | No Ral Code |   | No Ral Code |   |

| CAP CODE       |   | 00 | 02 | 03 | 04 | 06 | 08 | 09 | 30 | 32 | 33 | 34 | 38 | 40 | 42 | 50 | 53 | 57 | 58 |
|----------------|---|----|----|----|----|----|----|----|----|----|----|----|----|----|----|----|----|----|----|
| 1A             |  | •  | •  | •  | •  | •  | •  | •  |    |    |    |    |    |    |    |    |    |    |    |
| 1B             |  | •  | •  | •  | •  | •  | •  | •  |    |    |    |    |    |    |    |    |    |    |    |
| 1C             |  |    |    | •  |    |    | •  | •  |    |    |    |    |    |    |    |    |    |    |    |
| 1DS            |  | •  | •  | •  | •  | •  | •  | •  | •  | •  | •  | •  | •  | •  | •  | •  | •  | •  | •  |
| 1ES/1FS        |  | •  | •  | •  | •  | •  | •  | •  |    |    |    |    |    |    |    |    |    |    |    |
| 1GAS/1GCS      |  | •  | •  | •  | •  | •  | •  | •  |    |    |    |    |    |    |    |    |    |    |    |
| 1H             |  |    |    | •  |    |    |    | •  |    |    |    |    |    |    |    |    |    |    |    |
| 1JS            |  | •  | •  | •  | •  | •  | •  | •  |    |    |    |    |    |    |    |    |    |    |    |
| 1KS            |  | •  | •  | •  | •  | •  | •  | •  |    |    |    |    |    |    |    |    |    |    |    |
| 1M             |  | •  | •  | •  | •  | •  | •  | •  |    |    |    |    |    |    |    |    |    |    |    |
| 1NS            |  |    |    | •  |    |    |    | •  |    |    |    |    |    |    |    |    |    |    |    |
| 1PS            |  | •  | •  | •  | •  | •  | •  | •  |    |    |    |    |    |    |    |    |    |    |    |
| 1QS/1RS        |  | •  |    | •  |    |    |    | •  |    |    |    |    |    |    |    |    |    |    |    |
| 1SS/1LS        |  | •  | •  | •  | •  | •  | •  | •  |    |    |    |    |    |    |    |    |    |    |    |
| 1TS/1US/1VS    |  | •  |    | •  |    |    | •  | •  |    |    |    |    |    |    |    |    |    |    |    |
| 1WAS/1WDS/1WPS |  | •  |    | •  |    |    | •  | •  | •  |    |    |    |    | •  | •  |    | •  | •  |    |
| 1XS            |  | •  | •  | •  | •  | •  | •  | •  |    |    |    |    |    |    |    |    |    |    |    |
| 1ZA            |  |    |    | •  |    | •  |    | •  | •  |    |    |    |    | •  | •  | •  | •  | •  | •  |
| 1ZB            |  |    |    | •  |    | •  |    | •  | •  |    |    |    |    | •  | •  | •  | •  | •  | •  |
| 1ZCS           |  |    |    | •  |    | •  |    | •  | •  |    |    |    |    | •  | •  | •  | •  | •  | •  |
| 1Z/1ZW         |  | •  |    | •  |    | •  |    | •  |    |    |    |    |    |    |    |    |    |    |    |
| 10R/10RF + 10Q |  | •  | •  | •  | •  | •  | •  | •  |    |    |    |    |    |    |    |    |    |    |    |



- Module should be attached to the front plate with bolts (bolts not supplied by MEC)
- Round solution
- Ø34.25 mm
- h =11.7 mm; 12.2 mm
- Temp. Range:
  - Solid cap: -40/+65°C
  - Transparent cap: -40/+85°C
- Recommended panel cut-out: Ø35,0 - 35,5 Depending on application

All dimensions in mm

Tolerances +/-0.2mm

## DIMENSIONS

### Navimec Module

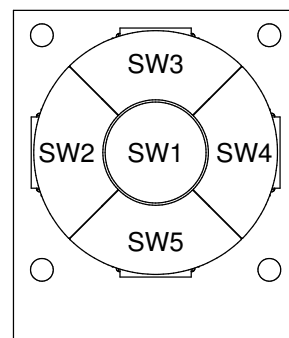

When the 1ZB is activated the diameter changes from 34,25 mm to 35,0 mm

## HOW TO ORDER

navimec<sup>™</sup> Module ordering options:

- navimec<sup>™</sup> Module excl. keycaps
- navimec<sup>™</sup> Module incl. keycaps
- navimec<sup>™</sup> Module incl. keycaps with legends
- Illuminated navimec<sup>™</sup> Module excl. keycaps
- Illuminated navimec<sup>™</sup> Module incl. keycaps with legends

Part no. for a module:

navimec<sup>™</sup> Module has many customisation options regarding actuation force, cap and LED colours and legends. Because of that "How to order" has been placed on page 43.

See previous page for information on switch and cap options.

SEE THE "HOW TO ORDER" GRAPH AS WELL AS CIRCUIT DIAGRAM AND CONNECTOR INFO ON [PAGE 43](#)

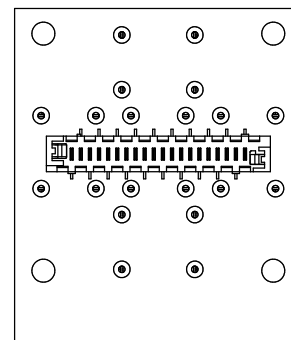

Ordering example:

95NA200913611806 (without illumination)

95NB350116LMH13612309 (with illumination)

Please see colour codes, updates of products and changes of specifications on [www.mec.dk](http://www.mec.dk)

Circuit diagram for switches



Circuit diagram for additional LEDs for controlmec™



Connectors on the module are Molex picoflex series 90816-0320 for switches and 90816-0316 for additional LEDs.  
We recommend using:  
Cable socket: 90327-0320 for switches and 90327-0316 for additional LEDs

## HOW TO ORDER - MODULES

| Module  | Cap                              | Type                     | Actuation force          | LED*                     |
|---|----------------------------------|--------------------------|--------------------------|--------------------------|
| <input type="checkbox"/> 9 <input type="checkbox"/> 5 | <input type="checkbox"/>         | <input type="checkbox"/> | <input type="checkbox"/> | <input type="checkbox"/> |
| <b>C</b> controlmec module                            | <b>A</b> non-illuminated         | <b>20</b> 2.0N**         | <b>02</b> blue           | <b>2242</b> green/yellow |
| <b>N</b> navimec module                               | <b>B</b> illuminated             | <b>35</b> 3.5N           | <b>22</b> green          | <b>8222</b> red/green    |
| <b>Q</b> 10Q module                                   | <u>Sealed controlmec module:</u> | <b>65</b> 6.5N           | <b>42</b> yellow         | <b>8242</b> red/yellow   |
| <b>R</b> 10R module                                   | <b>C</b> non-illuminated         |                          | <b>61</b> white          |                          |
|   | <b>D</b> illuminated             |                          | <b>82</b> red            |                          |

| Cap colour               | Legend type*                       | Legend on the edges*     | Legend in the centre*          | Legend colour*           |
|--------------------------|------------------------------------|--------------------------|--------------------------------|--------------------------|
| <input type="checkbox"/> | <input type="checkbox"/>           | <input type="checkbox"/> | <input type="checkbox"/>       | <input type="checkbox"/> |
| <b>09</b> black          | <b>(nothing)</b> pad printed       | <b>136</b> ▲             | <b>118</b> OK                  | <b>06</b> white          |
| <b>16</b> frosted white  | <b>LMH</b> hard paint laser marked |                          | <b>123</b> ☺                   | <b>09</b> black          |
|                          | <b>M</b> Metal                     |                          | ***Find more options on mec.dk |                          |

\*optional, \*\* 2.0N actuation force not recommended for controlmec

Ordering example:  
 95CB358216LMH13611809 - illuminated non-sealed controlmec  
 95CC650913612306 - non-illuminated panel sealed controlmec  
 95NB358216LMH13611809 - illuminated Navimec module  
 95QB200116M118 - illuminated 10Q module  
 95RA350912306 - non-illuminated 10R module  
 Please see colour codes, updates of products and changes of specifications on [www.mec.dk](http://www.mec.dk)



- Through-hole (TH) or surface mount (SMD)
- 50mA/24VDC
- Single pole/momentary
- 10,000,000 operations lifetime (NO function)
- Temperature range:
  - Switch: -40/+160°C
  - LED: -40/+85°C
- IP 67 sealing
- Actuation force: 2.0N, 3.5N, 6.5N
- NO or NC/NO

All dimensions in mm

Tolerances +/-0.2mm

### THROUGH-HOLE (TH)

5G



5G illuminated

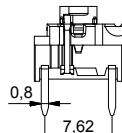

5E

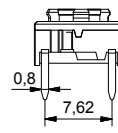

### PCB LAYOUT

Non-illuminated

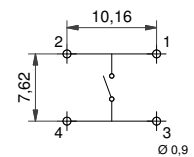

1 LED

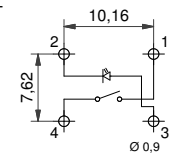

2 LED



### SURFACE MOUNT (SMD)

5G



5G illuminated



5E

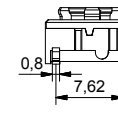

### PCB LAYOUT

Non-illuminated

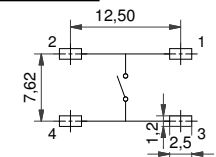

1 LED

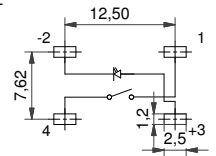

2 LED

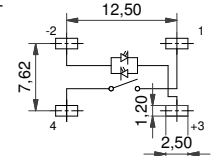

### NORMALLY CLOSED/NORMALLY OPEN FUNCTION

### NOT FOR SALE IN JAPAN

### CIRCUIT DIAGRAM

- Available for 5E and non-illuminated 5G in 3.5N actuation force.
- Same PCB layout as the NO 5E and 5G
- Housing colour is **grey**



### RIGHT ANGLE SWITCHES

### PCB LAYOUT

5E



5G



5G + 1SS

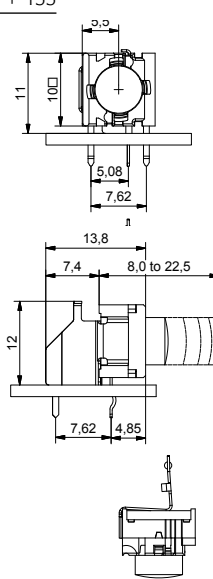

5G + 1DS



multimec® 5 series has only normally open (NO) non-illuminated right angle switch.

### ILLUMINATED – HOW TO ORDER

| Switch     | Mounting   | Actuation force  | LED  | Quiet (optional)          |
|------------|--|--|--|---------------------------|
| <b>5 G</b> | <input type="checkbox"/> <input type="checkbox"/> <input type="checkbox"/> | <input type="checkbox"/> <input type="checkbox"/> <input type="checkbox"/> | <input type="checkbox"/> <input type="checkbox"/> <input type="checkbox"/>                   | <input type="checkbox"/>  |
|            | <b>TH9</b> through-hole<br><b>SH9</b> surface mount                        | <b>20</b><br><b>35</b><br><b>65</b>  | <b>02</b> blue<br><b>22</b> green<br><b>42</b> yellow<br><b>61</b> white                     | <b>Q</b><br>only for 2.0N |
|            |  |  | <b>82</b> red<br><b>2242</b> green/yellow<br><b>8222</b> red/green<br><b>8242</b> red/yellow |                           |

### NON-ILLUMINATED – HOW TO ORDER

| Switch     | Mounting   | Actuation force  | RAS (optional)   | or                       | NC/NO (only for 3.5N)   |
|------------|--|--|--|--------------------------|---|
| <b>5 E</b> | <input type="checkbox"/> <input type="checkbox"/> <input type="checkbox"/> | <input type="checkbox"/> <input type="checkbox"/> <input type="checkbox"/> | <input type="checkbox"/> <input type="checkbox"/> <input type="checkbox"/> | <input type="checkbox"/> | <input type="checkbox"/> <input type="checkbox"/> <input type="checkbox"/> <input type="checkbox"/> |
|            | <b>TH9</b> through-hole<br><b>SH9</b> surface mount                        | <b>20</b><br><b>20Q</b><br><b>35</b><br><b>65</b>                          | <b>RAS</b> right angle switch  |                          | <b>NCNO</b> normally closed/<br>normally open function  |

| Switch     | Mounting   | Actuation force  | RAS (optional)   | or                       | NC/NO (only for 3.5N)   |
|------------|--|--|--|--------------------------|---|
| <b>5 G</b> | <input type="checkbox"/> <input type="checkbox"/> <input type="checkbox"/> | <input type="checkbox"/> <input type="checkbox"/> <input type="checkbox"/> | <input type="checkbox"/> <input type="checkbox"/> <input type="checkbox"/> | <input type="checkbox"/> | <input type="checkbox"/> <input type="checkbox"/> <input type="checkbox"/> <input type="checkbox"/> |
|            | <b>TH9</b> through-hole<br><b>SH9</b> surface mount                        | <b>20</b><br><b>20Q</b><br><b>35</b><br><b>65</b>                          | <b>RAS</b> right angle switch  |                          | <b>NCNO</b> normally closed/<br>normally open function  |

Ordering example: 5ESH935 (non-illuminated), 5GTH9658222 (illuminated), 5GSH935NCNO (normally closed/normally open); 5ETH920RAS (right angle) 5ETH920Q or 5GSH92061Q (quiet versions)

Please see colour codes, updates of products and changes of specifications on [www.mec.dk](http://www.mec.dk)



### Basic switch spacing

through-hole (TH)



surface mount (SMD)



### Recommended switch/cap spacing

Switch spacing



Cap dimensions



Panel cut-out

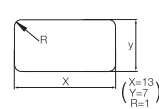

### Panel cut-out

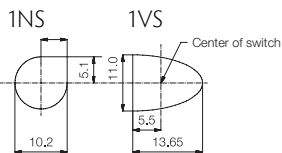

### Spacing examples

multimec  
5GT+1B/C+2C/D

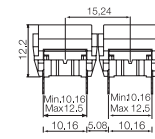

multimec  
5GS+1B/C+2C/D

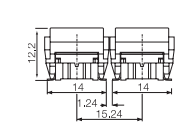

multimec  
5GT + 1A/H

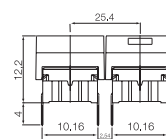

multimec  
5GT + 1M

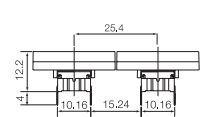

multimec  
1NS + 1NS + 1NS

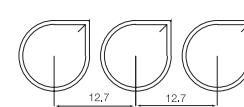

multimec  
1VS + 1TS+ 1VS

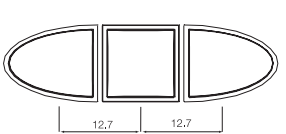

| Cap series    | Recommended<br>min. switch spacing AxB | Nominal cap dimension<br>WxH | Recommended<br>min. panel cut-out |
|---------------|--|------------------------------|-----------------------------------|
| 1A/1H         | 12.7x10.16                             | 12.6x10.1                    | 13.0x10.5                         |
| 1B/1C+2C/2D   | 15.24x15.24                            | 15.1x15.1                    | 15.5x15.5                         |
| 1DS/1ES/1FS   | 12.7x12.7                              | ø9.6                         | ø10.0                             |
| 1GAS          | 12.7x11.14                             | ø11                          | ø11.4                             |
| 1GCS          | 15.14x15.14                            | ø15                          | ø15.4                             |
| 1JS           | 12.7x12.7                              | ø9.6                         | ø10.4                             |
| 1KS/1KBS/1KCS | 15.24x15.24                            | 14.3x14.3                    | 14.7x14.7                         |
| 1M            | 25.4x10.16                             | 25.0x10.                     | 25.7x10.5                         |
| 1NS           | 12.7x12.7                              | ø9.8/□4.9                    | ø10.2/□5.1                        |
| 1PS/1QS/1RS   | 15.24x10.16                            | 6.5x12.5                     | 7.0x13.0, R max. 1.0              |
| 1SS/1IS/1LS   | 12.7x12.7                              | ø6.5                         | ø7.0                              |
| 1TS           | 12.7x12.7                              | 10.6x10.6                    | 11.0x11.0                         |
| 1US           | 12.7x12.7                              | ø10.6                        | ø11.0                             |
| 1VS           | 12.7x12.7                              | 10.6x13.25                   | 11.0x13.65                        |
| 1WAS/1WPS     | 12.7x10.3                              | 12.5x6.5                     | 12.9x6.9                          |
| 1WDS          | 15.34x10.3                             | 15.2x8.0                     | 15.6x8.4                          |
| 1XS           | 12.7x12.7                              | 9.4x7.4                      | 9.8x7.9                           |
| 1YS           | 17x17                                  | 15x15                        | 16x16                             |
| 1ZA           | 18.84x10.3                             | 18.7x10.1                    | 19.4x10.5                         |
| 1ZB           | 24.34x12.1                             | R1=7.4; R2=17.5 90°          | R1=7.1; R2=17.5-17.75 90°         |
| 1ZCS          | 14.44x14.44                            | ø14.3                        | ø14.7                             |
| 1Z/1ZW        | 35.5x35.5; 41.6x41.6                   | ø29.5                        | ø30.3                             |
| 10R/10RF/10RM | 40.5x40.5                              | ø30.0                        | ø30.6                             |
| 10Q/10QM      | 32.5x32.5                              | 22x22                        | 22.5x22.5                         |

## Tape & Reel

Tape and reel is available for the parts listed and has the following specifications:

|                |          |                         |                      |
|----------------|----------|-------------------------|----------------------|
| Reel diameter: | Ø330mm   | Tape and reel material: | antistatic or better |
| Tape width:    | 24mm     | Quantity per reel:      | see list             |
| Pitch:         | see list |                         |                      |

### 3C/3E/5E/5G multimec® tape & reel

| Part No.                                  | Ordering Code      | Pitch | Quantity per reel |
|---|--------------------|-------|-------------------|
| 3CSH9                                     | 3CSH9R             | 16    | 500               |
| 3ESH9                                     | 3ESH9R             | 16    | 500               |
| 5ESH9XX                                   | 5ESH9XXR           | 16    | 500               |
| 5GSH9XX                                   | 5GSH9XXR           | 16    | 500               |
| 5XSH9XX1SSXX-08.0                         | 5XSH9XXR1SSXX-08.0 | 20    | 250               |
| 5XSH9XX1SSXX-09.5                         | 5XSH9XXR1SSXX-09.5 | 20    | 250               |
| 5XSH9XX1SSXX-10.4                         | 5XSH9XXR1SSXX-10.4 | 20    | 250               |
| 5XSH9XX1SSXX-11.0                         | 5XSH9XXR1SSXX-11.0 | 20    | 250               |
| 5XSH9XX1SSXX-12.0                         | 5XSH9XXR1SSXX-12.0 | 20    | 250               |
| All varimec h <12.5; add R after part no. |                    |       | 20 250            |

### illuminated 5G multimec® tape & reel

| Part No.    | Ordering Code | Pitch | Quantity per reel |
|-------------|---------------|-------|-------------------|
| 5GSH9XX02   | 5GSH9XX02R    | 20    | 250               |
| 5GSH9XX22   | 5GSH9XX22R    | 20    | 250               |
| 5GSH9XX42   | 5GSH9XX42R    | 20    | 250               |
| 5GSH9XX61   | 5GSH9XX61R    | 20    | 250               |
| 5GSH9XX82   | 5GSH9XX82R    | 20    | 250               |
| 5GSH9XX2242 | 5GSH9XX2242R  | 20    | 250               |
| 5GSH9XX8222 | 5GSH9XX8222R  | 20    | 250               |
| 5GSH9XX8242 | 5GSH9XX8242R  | 20    | 250               |

## How to assemble

multimec®  
5GS+1A/H

multimec®  
5GS+1B/C+2C/D



## Operating force

(typical example)

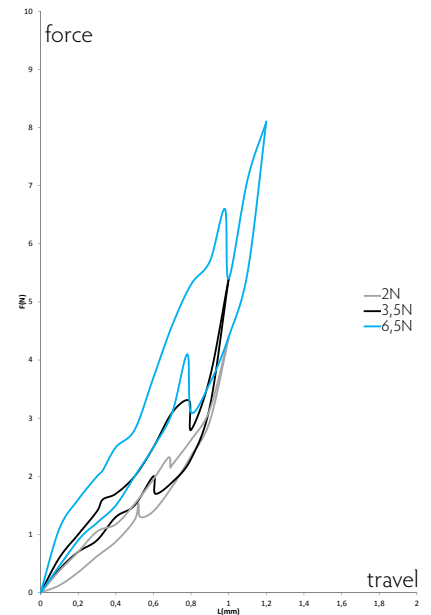

## Mounting tool for multimec® through-hole switches

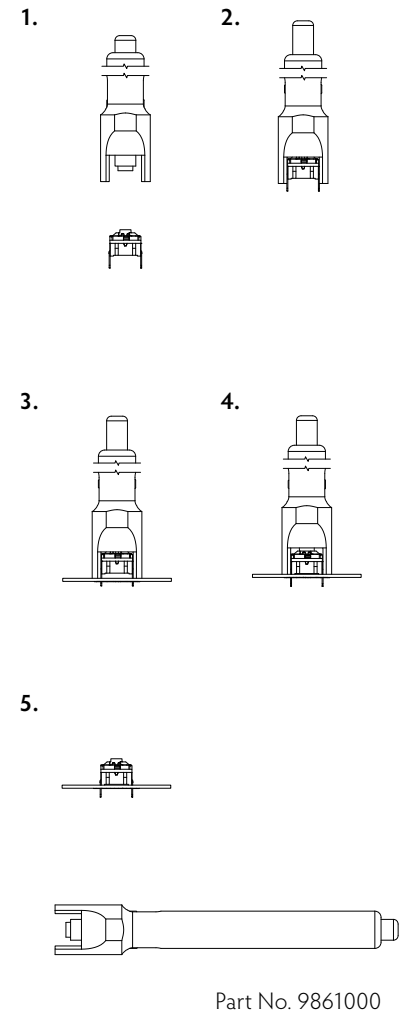

## RoHS Compatible

|   | HIGH TEMPERATURE VERSIONS  |                               |                   |
|---|--|-------------------------------|-------------------|
|   | SILVER   | GOLD                          | NC/NO             |
| <b>ELECTRICAL SPECIFICATIONS</b>          |  |                               |                   |
| Contact resistance                        | <30m Ω - typ. 10m Ω  |                               |                   |
| Insulation resistance                     | >10M Ω   |                               |                   |
| Recommended load                          | 0.5-50mA 24VDC   | 0.5μ-50mA 24VDC               |                   |
| Contact bounce                            | <2mS - typically 0.5mS   |                               |                   |
| <b>MECHANICAL SPECIFICATIONS</b>          |  |                               |                   |
| Standard actuation force (switch)         | 2.0N, 3.5N, 6.5 N  |                               | 3.5N              |
| Max. Actuation force without cap          | 115N for 60 sec  | (according to MIL-PRF-22885H) | 100N for 10 sec   |
| Key travel (switch)                       | 1 mm   |                               |                   |
| Life time (switch)                        | >10,000,000 cycles   |                               | >1,000,000 cycles |
| <b>TEMPERATURE RANGE</b>                  |  |                               |                   |
| Working temperature                       | Min -40°C Max +160°C   |                               |                   |
| Storage temperature                       | Min -40°C Max +160°C   |                               |                   |
| 5G with LED (working & storage temp)      | Min -30°C Max +85°C  |                               |                   |
| Soldering (through-hole switch)           | IEC 68-2-20 8:   |                               |                   |
|   | Infrared, vapour phase, wave - max 240°C for max 40 sec or max 260°C for max 30 sec. |                               |                   |
|   | Soldering iron - max 350°C for max 3 sec.  |                               |                   |
|   | Flux tight.  |                               |                   |
| <b>SOLDERING (SMD)</b>                    | JEDEC J-STD-020C   |                               |                   |
| <b>ENVIRONMENTAL ENDURANCE IEC 68-2-3</b> |  |                               |                   |
| Temperature                               | +40°C  |                               |                   |
| Humidity                                  | 93% RH   |                               |                   |
| Duration                                  | 56 Days  |                               |                   |
| <b>TEMPERATURE CYCLING IEC 68-2-14</b>    |  |                               |                   |
| Temperature limit                         | Min -55°C - Max +85°C  |                               |                   |
| Number of cycles                          | 200  |                               |                   |
| Exposure time at each temperature         | 10 min   |                               |                   |
| Recovery time before measurements         | 16 hrs   |                               |                   |
| Sealing IEC 529                           | IP-67  |                               |                   |
| Cleaning                                  | Standard methods - see usage guidelines  |                               |                   |
| <b>MATERIAL SPECIFICATIONS - SWITCHES</b> |  |                               |                   |
| Housing                                   | PPS UL94V0   |                               |                   |
| Actuator                                  | PPS UL94V0   |                               |                   |
| Sealing + spring                          | Silicone rubber  |                               |                   |
| Contact spring                            | Stainless steel  |                               | Stainless steel   |
|   | + 3μAg   |                               | + 1μAu            |
| Fixed contacts                            | SnCu + 2μNI + 3μAg   | SnCu + 2μNI + 1μAu            |                   |
| Terminals                                 | SnCu + 2μNI + 3μSn100  |                               |                   |

## Caps, Bezels & Legends – Material Specifications

| MATERIAL         | PARTS   | TEMP. LIMIT | UL RATING |
|------------------|---|-------------|-----------|
| ABS              | 1A, 1B, 1C, 1DS, 1ES, 1FS, 1H, 1JS, 1KS, 1LS, 1M, 1NS, 1PS, 1QS, 1RS, 1TS, 1US, 1VS, 1WAS, 1WDS, 1WPS, 1XS, 1Z, 1ZA, 1ZB, 1ZCS, 1ZW, 2C, 2D, 2K, reflectors for 1KBS/1KCS and 1YS | Max. 65°C   | UL94HB    |
| Polycarbonate    | All lenses and transparent colour caps, lids for 1KBS/1KCS  | Max. 85°C   | UL94HB    |
| Polyamide        | 1GAS/1GCS, 1SS, 2SS   | Max. 160°C  | UL94V2    |
| Legends Adhesion | DS/EN ISO 2409 Class 1 & ASTM D3359 Class 4B  |             |           |

### LEDs specifications

#### 5G switches

| Colour  |          | Blue                | Green   | Yellow  | White   | Red     | High Intensity Green |
|---|----------|---------------------|---------|---------|---------|---------|----------------------|
| Colour Codes  |          | 02                  | 22      | 42      | 61      | 82      | 29                   |
| <b>ABSOLUTE MAXIMUM RATINGS (Ta=25°C)</b>           |          |                     |         |         |         |         |                      |
| Power   | mW       | 95                  | 75      | 60      | 48      | 65      | 102.5                |
| Current forward                                     | mA       | 25                  | 30      | 25      | 15      | 25      | 25                   |
| Forward peak current                                | mA       | 100                 | 80      | 60      | 100     | 100     | 150                  |
| Voltage reverse                                     | V        | 5                   | 5       | 5       | NA      | 12      | 5                    |
| Operating temperature                               | °C       | -40/+85             | -55/+85 | -40/+85 | -40/+85 | -30/+85 | -40/+85              |
| Storage temperature                                 | °C       | -40/+90             | -55/+85 | -40/+90 | -40/+85 | -40/+85 | -40/+85              |
| Soldering temperature                               | °C       | 245 for max. 10 sec |         |         |         |         |                      |
| <b>ELECTRICAL-OPTICAL CHARACTERISTICS (Ta=25°C)</b> |          |                     |         |         |         |         |                      |
| Voltage forward                                     | Typ. V   | 3.3                 | 2       | 1.75**  | 2.85    | 2       | 3.3                  |
|   | Max. V   | 3.7                 | 2.4     | 2.35    | 3.1     | 2.5     | 4.1                  |
| Current reverse (VR=5V)                             | Max. µA  | 50                  | 100     | 10      | NA      | 100     | 50                   |
| Wave length   | nm       | 470                 | 571     | 591     | NA      | 633     | 525                  |
| Spread  | Δnm      | 25                  | NA      | 15      | NA      | 16      | 30                   |
| Spread angle  | degree   | 120                 | 130     | 120     | 150     | 160     | 60                   |
| <b>Luminous Intensity</b>                           | Min. mcd | 45                  | 18      | 28.5    | 71      | 28      | 500                  |
|   | Typ. mcd | 112*                | 35      | 72*     | 224*    | 180*    | 1000                 |
| Optical intensity                                   | Lm/w     | NA                  | NA      | NA      | 36      | 7       | NA                   |

\*Max.mcd \*\*Min. V

#### 3F switches

#### 3FXXX (for 1E-1F-1N-1Q-1R-1S-1X)

#### 3FXXX (for 1K-1T-1U-1V-1W-1WD)

| Colour  |  | B                 | G    | Y    | W        | R        | G/Y     | R/G               | R/Y     | G       | Y                 | R                 |  |
|---|--|-------------------|------|------|----------|----------|---------|-------------------|---------|---------|-------------------|-------------------|--|
| Colour Codes  |  | 00                | 20   | 40   | 65       | 80       | 2040    | 8020              | 8040    | 24      | 46                | 87                |  |
| <b>Absolute Maximum Ratings</b>                     | (Ta=25°C)  |                   |      |      |          |          |         |                   |         |         |                   |                   |  |
| Power   | mW   | 105               | 70   | 60   | 120      | 60       | 120     | 100               | 120     | 60      | 60                | 120               |  |
| Current forward                                     | mA   | 30                | 20   | 20   | 25       | 20       | 25      | 30                | 25      | 25      | 25                | 50                |  |
| Forward peak current                                | mA   | 150               | 60** | 60** | 100      | 60**     | 150     | 120               | 150     | 60      | 60                | 200               |  |
| Voltage reverse                                     | V  | 5                 | 3    | 3    | 5        | 3        | 5       | 5                 | 5       | 5       | 5                 | 5                 |  |
| Operating temperature                               | °C   | -40/+85           |      |      | -40/+85  | -25/+85  | -40/+85 | -55/+100          | -40/+85 | -40/+85 | -40/+85           | -40/+85           |  |
| Storage temperature                                 | °C   | -40/+85           |      |      | -40/+100 | -30/+100 | -40/+85 | -55/+100          | -40/+85 | -40/+85 | -40/+100          | -40/+100          |  |
| Soldering temperature                               | °C   | 260 for max 5 sec |      |      |          |          |         | 260 for max 2 sec |         |         | 300 for max 3 sec | 260 for max 5 sec |  |
| <b>Electrical-Optical Characteristics (Ta=25°C)</b> |  |                   |      |      |          |          |         |                   |         |         |                   |                   |  |
| Voltage forward                                     | Typ. V   | 3.8               | 2.1  | 2.1  | 3.8      | 2.0      | 2.1     | 2.0               | 2.1     | 2.0*    | 2.0               | 2.0***            |  |
|   | Max. V   | 4.5               | 3.0  | 3.0  | 4.3      | 3.0      | 2.8     | 2.6               | 2.8     | 2.4*    | 2.4               | 2.4***            |  |
| Current reverse (VR=5V)                             | µA   | 10                | 10   | 10   | 50       | 10       | 2       | 2                 | 2       | 10      | 10                | 10                |  |
| Wave length   | nm   | 466               | 563  | 585  | NA       | 650      | 565/590 | 630/565           | 625/590 | 570     | 589               | 624/632           |  |
| Spread  | Δnm  | 60                | 40   | 40   | NA       | 40       | 35      | 35                | 35      | 10      | NA                | 20                |  |
| Spread angle  | degree   | 60                | 45   | 45   | 25       | 45       | 60      | 200               | 60      | 100     | 40                | 40                |  |
| <b>Luminous Intensity</b>                           | Min. mcd   | 18                | 9.0  | 5.6  | 630      | 5.6      | 8       | 2.2               | 8       | 70****  | 630               | 400****           |  |
|   | Typ. mcd   | 50                | 25   | 16   | 1000     | 16       | 25      | 4.8               | 25      | 20****  | 1250              | 800****           |  |
| Orientation   | The longer pin is the anode, the shorter is the cathode.<br>For bicolour LEDs the anode for the first colour (ex. 2080) is the longer pin. |                   |      |      |          |          |         |                   |         |         |                   |                   |  |

\*\*Pulse width 1ms Duty cycle 1:5, \*\*\*/F =50mA, \*\*\*\* Luminous Flux mlm

B=Blue, G=Green, Y=Yellow, R=Red, W=White

Specifications are subject to change without notice.

Specifications are subject to change without notice.

For product updates and/or changes of specifications please see [www.mec.dk](http://www.mec.dk)

# Usage guidelines

## How to get the best results with MEC Switches?

These guidelines are offered to users of MEC Switches as an aid to ensure successful and reliable switch operation.

### Temperature

Both unimec™ and multimec® switches are produced in low and high temperature versions. Please see the technical specifications for details on operating and storage temperatures and soldering guidelines to make sure you select the best switch for your application. When wave soldering is taking place, MEC strongly recommend that the temperature profile is analysed and compared with the temperature rating of the switch. In case of doubt always select the high temperature versions unimec™ 154XX, and multimec® 5XXH9XX. It is also important to monitor the accumulated heat build up from both the pre-heat zones and the solder zone.

Most standard accessories for both unimec™ and multimec® switches are made from ABS plastic with a maximum operating temperature of 65°C. It is strongly recommended that accessories are mounted after soldering of the switch. If this is not possible care must be taken not to overheat the accessories during the soldering process. The 1SS, 1GAS/1GCS and Varimec™ caps are, however, made of high temperature materials and will meet the same temperature specifications as the high temperature switches.

For accessories made from other plastic materials please see multimec® and unimec™ technical specifications.

LEDs have their own temperature specifications. When fitted in a high temperature switch the LED will determine the max. operating temperature, i.e. 5GTH93524 has an upper temperature limit of 85°C! This also applies with 3F switches.

### Mounting and Dismounting

If switches are to be mounted in rows it is essential that the recommendations regarding spacing are followed. PC board thickness should be 1.4±0.2 mm and terminal hole diameter should be 0.9mm.

All unimec™ and multimec® caps and bezels are easily snapped onto the switch modules and can be changed at a later time with the exception of the unimec 16.700 cap. The same applies to the 3E caps. Once these caps are installed they are not designed to be removed. To do so may cause damage to the switch and the PC board if not done very carefully. If the 16.300 or 16.700 cap must be removed from a unimec™ alternate action switch, make sure that the switch actuator is in the released, upper position before attempting to remove the cap. This will prevent possible damage to the internal latching pin.

Care must be taken when inserting the 3FT switch and LED assembly into the PC board. Do not press direct on the LED. This will force the LED down into the actuator and risks to cause the switch contacts to remain in the closed position. To correct the fault, the LED must be raised slightly and centered in the actuator to assure unrestricted movement of the actuator. A mounting tool is available for multimec® switches.

### Soldering and Cleaning unimec™

Most assembly and field problems experienced by users of unsealed switches are caused by the contamination of the contacts during soldering and cleaning.

Contact contamination may be recognised by an increase in contact resistance and possible intermittent operation of the switch, especially in low power applications. Care must be taken not to submerge the switch in cleaning agents or spray the switch during cleaning. The switch must be protected at all times to prevent contamination by flux or cleaning liquids.

For unimec™ alternate versions we recommend to leave the actuator in the released upper position during soldering. This makes the switch more resistant to overheating.

### Soldering and Cleaning multimec®

multimec® switches are fully sealed to IP67 specifications to prevent solder flux and aqueous based cleaning solutions from entering the switch and contaminating the contacts. The switches can be placed on the PC board with other components and wave soldered. multimec® offers a high level of sealing, however, with aqueous solvent solutions care must be taken to avoid the worst case situation with water jets, complete immersion into a liquid with a temperature below the board or surface tension reducing additives.

Recommended cleaning methods are demineralized water. Any surface tension reducing agents, such as soap, must not be used as they risk causing a potential leakage of the switch.

### Soldering - Through Hole Versions

Hand soldering: Max. 350°C for max. 3 sec., this applies for both low temperature and high temperature versions.

Wave soldering: heat built up in the switch during pre-heating and soldering must not exceed the maximum operating temperature of the switch. If, for some reason, a high pre-heating temperature is required, MEC recommend the high temperature switches. In any case peak temperature must not exceed 260°C, and soldering time is max 10 sec.

### Soldering - Surface Mount Versions

For all methods - infrared, convection and vapour phase. The upper limit 260°C/30 sec must be observed. The soldering temperature profile must have moderate temperature gradients.

### RoHS Compliance

As of 1 July 2006 MEC has completed the conversion to RoHS compliance. For more info please see our homepage [www.mec.dk](http://www.mec.dk)

### Temperature Limits:

|                         |             |
|-------------------------|-------------|
| Low temperature switch  | 115°C       |
| High temperature switch | 160°C       |
| LEDs                    | 85/100°C    |
| Accessories             | 65/85/160°C |

### Packaging

unimec™ and multimec® switches are packed in rigid tubes of 50 pieces each.

A box contains 1.000 pcs.

The surface mount versions of multimec® switches with a height up to 12.5mm can also be delivered on tape/reel. Each reel contains 250/500 pcs.

Компания «Океан Электроники» предлагает заключение долгосрочных отношений при поставках импортных электронных компонентов на взаимовыгодных условиях!

Наши преимущества:

- Поставка оригинальных импортных электронных компонентов напрямую с производств Америки, Европы и Азии, а так же с крупнейших складов мира;
- Широкая линейка поставок активных и пассивных импортных электронных компонентов (более 30 млн. наименований);
- Поставка сложных, дефицитных, либо снятых с производства позиций;
- Оперативные сроки поставки под заказ (от 5 рабочих дней);
- Экспресс доставка в любую точку России;
- Помощь Конструкторского Отдела и консультации квалифицированных инженеров;
- Техническая поддержка проекта, помощь в подборе аналогов, поставка прототипов;
- Поставка электронных компонентов под контролем ВП;
- Система менеджмента качества сертифицирована по Международному стандарту ISO 9001;
- При необходимости вся продукция военного и аэрокосмического назначения проходит испытания и сертификацию в лаборатории (по согласованию с заказчиком);
- Поставка специализированных компонентов военного и аэрокосмического уровня качества (Xilinx, Altera, Analog Devices, Intersil, Interpoint, Microsemi, Actel, Aeroflex, Peregrine, VPT, Syfer, Eurofarad, Texas Instruments, MS Kennedy, Miteq, Cobham, E2V, MA-COM, Hittite, Mini-Circuits, General Dynamics и др.);

Компания «Океан Электроники» является официальным дистрибьютором и эксклюзивным представителем в России одного из крупнейших производителей разъемов военного и аэрокосмического назначения «JONHON», а так же официальным дистрибьютором и эксклюзивным представителем в России производителя высокотехнологичных и надежных решений для передачи СВЧ сигналов «FORSTAR».



## JONHON

«JONHON» (основан в 1970 г.)

Разъемы специального, военного и аэрокосмического назначения:

(Применяются в военной, авиационной, аэрокосмической, морской, железнодорожной, горно- и нефтедобывающей отраслях промышленности)

«FORSTAR» (основан в 1998 г.)

ВЧ соединители, коаксиальные кабели,  
кабельные сборки и микроволновые компоненты:

(Применяются в телекоммуникациях гражданского и специального назначения, в средствах связи, РЛС, а так же военной, авиационной и аэрокосмической отраслях промышленности).



Телефон: 8 (812) 309-75-97 (многоканальный)

Факс: 8 (812) 320-03-32

Электронная почта: [ocean@oceanchips.ru](mailto:ocean@oceanchips.ru)

Web: <http://oceanchips.ru/>

Адрес: 198099, г. Санкт-Петербург, ул. Калинина, д. 2, корп. 4, лит. А