

Advanced Performance and Wide Range of Selections in a Super-compact Size



- Only 5.5 × 5.5 mm with a built-in Amplifier.
- Maximum sensing distance: 2.5 mm. Stable detection even with workpiece fluctuations.
- Response frequency: 1 kHz.
- Low current consumption.



For the most recent information on models that have been certified for safety standards, refer to your OMRON website.



Be sure to read *Safety Precautions* on page 6.

Ordering Information

Sensors [Refer to *Dimensions* on page 7.]

DC 2-Wire Models

Appearance	Sensing surface	Sensing distance	Model	
			Operation mode	
			NO	NC
Unshielded 	Top	1.6 mm	E2S-W11 1M *1 *2	E2S-W12 1M
	Front		E2S-Q11 1M *1 *2	E2S-Q12 1M
	Top	2.5 mm	E2S-W21 1M *1 *2	E2S-W22 1M *2
	Front		E2S-Q21 1M *1 *2	E2S-Q22 1M *2

*1. Models with a different frequency are also available to prevent mutual interference. The model numbers are E2S-□□□B (e.g., E2S-W11B).

*2. Models are also available with robotics (bend resistant) cables. Add "-R" to the model number.(e.g., E2S-W11-R 1M)

DC 3-Wire Models

Appearance	Sensing surface	Sensing distance	Output configuration	Model	
				Operation mode	
				NO	NC
Unshielded 	Top	1.6 mm	NPN	E2S-W13 1M *1 *2	E2S-W14 1M
	Front			E2S-Q13 1M *1 *2	E2S-Q14 1M
	Top	2.5 mm		E2S-W23 1M *1 *2	E2S-W24 1M *2
	Front			E2S-Q23 1M *1 *2	E2S-Q24 1M *2
	Top	1.6 mm	PNP	E2S-W15 1M *1	E2S-W16 1M
	Front			E2S-Q15 1M *1	E2S-Q16 1M
	Top	2.5 mm		E2S-W25 1M *1	E2S-W26 1M
	Front			E2S-Q25 1M *1	E2S-Q26 1M

*1. Models with a different frequency are also available to prevent mutual interference. The model numbers are E2S-□□□B (e.g., E2S-W13B).

*2. Models are also available with robotics (bend resistant) cables. Add "-R" to the model number.(e.g., E2S-W13-R 1M)

Accessories (Order Separately)

Mounting Brackets Some Mounting Brackets are provided with the Sensor. Order other Mounting Brackets separately if required.

[Refer to *Dimensions* on page 7.]

Appearance	Model	Quantity	Remarks
	Y92E-C1R6	1	Provided with E2S-□1□□. (fixed with one screw)
	Y92E-C2R5		Provided with E2S-□2□□. (fixed with one screw)
	Y92E-D1R6		For E2S-□1□□ (fixed with two screws)
	Y92E-D2R5		For E2S-□2□□ (fixed with two screws)

Model Number Legend

E2S- □ □ □ □ - □
 (1) (2) (3) (4) (5) (6)



Ratings and Specifications

DC 2-Wire Models

Item	Model	E2S-W11 E2S-W12	E2S-Q11 E2S-Q12	E2S-W21 E2S-W22	E2S-Q21 E2S-Q22
	Sensing surface		Top	Front	Top
Sensing distance		1.6 mm ±15%		2.5 mm ±15%	
Set distance		0 to 1.2 mm		0 to 1.9 mm	
Differential travel		10% max. of sensing distance			
Detectable object		Ferrous metal (The sensing distance decreases with non-ferrous metal. Refer to <i>Engineering Data</i> on page 4.)			
Standard sensing object		Iron, 12 × 12 × 1 mm		Iron, 15 × 15 × 1 mm	
Response frequency *		1 kHz min.			
Power supply voltage (operating voltage range)		12 to 24 VDC (10 to 30 VDC), ripple (p-p): 10% max.			
Leakage current		0.8 mA max.			
Control output	Load current	3 to 50 mA max.			
	Residual voltage	3 V max. (under load current of 50 mA with cable length of 1 m)			
Indicators		<input type="checkbox"/> 1 Models: Operation indicator (red), Setting indicator (green) <input type="checkbox"/> 2 Models: Operation indicator (red)			
Operation mode (with sensing object approaching)		<input type="checkbox"/> 1 Models: NO <input type="checkbox"/> 2 Models: NC Refer to the timing charts under <i>I/O Circuit Diagrams</i> on page 5 for details.			

* The response frequency is an average value.

Measurement conditions are as follows: standard sensing object, a distance of twice the standard sensing object, and a set distance of half the sensing distance.

DC 3-Wire Models

Item	Model	E2S-W13 E2S-W14	E2S-Q13 E2S-Q14	E2S-W23 E2S-W24	E2S-Q23 E2S-Q24	E2S-W15 E2S-W16	E2S-Q15 E2S-Q16	E2S-W25 E2S-W26	E2S-Q25 E2S-Q26
	Sensing surface		Top	Front	Top	Front	Top	Front	Top
Sensing distance		1.6 mm ±15%		2.5 mm ±15%		1.6 mm ±15%		2.5 mm ±15%	
Set distance		0 to 1.2 mm		0 to 1.9 mm		0 to 1.2 mm		0 to 1.9 mm	
Differential travel		10% max. of sensing distance							
Detectable object		Ferrous metal (The sensing distance decreases with non-ferrous metal. Refer to <i>Engineering Data</i> on page 4.)							
Standard sensing object		Iron, 12 × 12 × 1 mm		Iron, 15 × 15 × 1 mm		Iron, 12 × 12 × 1 mm		Iron, 15 × 15 × 1 mm	
Response frequency *		1 kHz min.							
Power supply voltage (operating voltage range)		12 to 24 VDC (10 to 30 VDC), ripple (p-p): 10% max.							
Current consumption		13 mA max. at 24 VDC (no-load)							
Control output	Load current	NPN open-collector output, 50 mA max. (30 VDC max.)				PNP open-collector output, 50 mA max. (30 VDC max.)			
	Residual voltage	1.0 V max. (under load current of 50 mA with cable length of 1 m)							
Indicators		Operation indicator (orange)							
Operation mode (with sensing object approaching)		<input type="checkbox"/> 3 Models: NO <input type="checkbox"/> 4 Models: NC Refer to the timing charts under <i>I/O Circuit Diagrams</i> on page 5 for details.				<input type="checkbox"/> 5 Models: NO <input type="checkbox"/> 6 Models: NC Refer to the timing charts under <i>I/O Circuit Diagrams</i> on page 5 for details.			

* The response frequency is an average value.

Measurement conditions are as follows: standard sensing object, a distance of twice the standard sensing object, and a set distance of half the sensing distance.

Specifications

Item	Model	E2S-□□□
Protection circuits	Reverse polarity protection, Surge suppressor	
Ambient temperature range	Operating: -25 to 70°C (with no icing or condensation), Storage: -40 to 85°C (with no icing or condensation)	
Ambient humidity range	Operating: 35% to 90% (with no condensation), Storage: 35% to 95% (with no condensation)	
Temperature influence	±15% max. of sensing distance at 23°C in the temperature range of -25 to 70°C	
Voltage influence	±2.5% max. of sensing distance at rated voltage in rated voltage ±10% range	
Insulation resistance	50 MΩ min. (at 500 VDC) between current-carrying parts and case	
Dielectric strength	1,000 VAC for 1 min between current-carrying parts and case	
Vibration resistance	Destruction: 10 to 55 Hz, 1.5-mm double amplitude for 2 hours each in X, Y, and Z directions	
Shock resistance	Destruction: 500 m/s ² 3 times each in X, Y, and Z directions	
Degree of protection	IEC 60529 IP67	
Connection method	Pre-wired Models (Standard cable length: 1 m)	
Weight (packed state)	Approx. 10 g	
Materials	Case	Polyarylate resin
Accessories	Mounting Brackets	

Engineering Data (Reference Value)

Sensing Area

E2S-W1□/-W2□

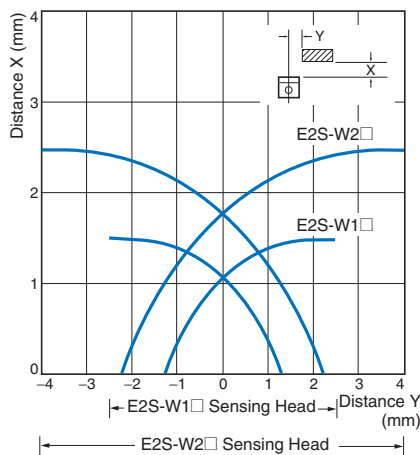

E2S-Q1□/-Q2□



Influence of Sensing Object Size and Material

E2S-W1□/-Q1□

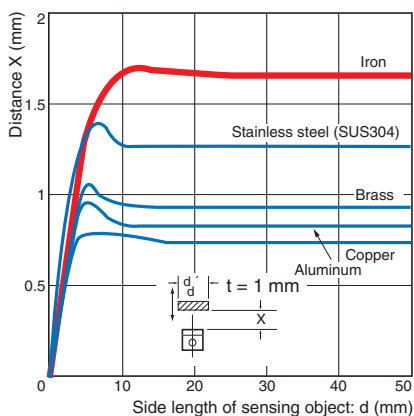

E2S-W2□/-Q2□

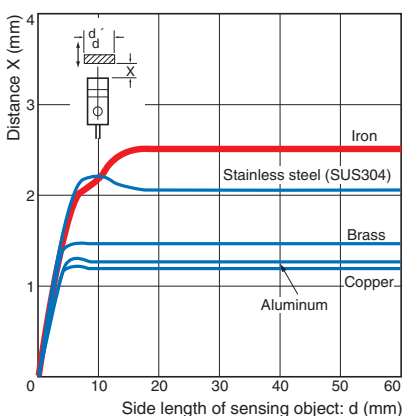

I/O Circuit Diagrams

DC 2-Wire Models

Operation mode	Model	Timing chart	Output circuit
NO	E2S-W11 E2S-W21 E2S-Q11 E2S-Q21		<p>Note: The load can be connected to either the +V or 0 V side.</p>
NC	E2S-W12 E2S-W22 E2S-Q12 E2S-Q22		

DC 3-Wire Models

Operation mode	Output configuration	Model	Timing chart	Output circuit
NO	NPN	E2S-W13 E2S-W23 E2S-Q13 E2S-Q23		<p>* Load current: 50 mA max.</p>
NC		E2S-W14 E2S-W24 E2S-Q14 E2S-Q24		
NO	PNP	E2S-W15 E2S-W25 E2S-Q15 E2S-Q25		<p>* Load current: 50 mA max.</p>
NC		E2S-W16 E2S-W26 E2S-Q16 E2S-Q26		

Safety Precautions

Refer to *Warranty and Limitations of Liability*.

⚠ WARNING

This product is not designed or rated for ensuring safety of persons either directly or indirectly. Do not use it for such purposes.



Precautions for Correct Use

Do not use this product under ambient conditions that exceed the ratings.

● **Design**

Influence of Surrounding Metal

- When mounting the Sensor within a metal panel, ensure that the clearances given in the following table are maintained. Failure to maintain these distances may cause deterioration in the performance of the Sensor.
- Models with Top Sensing Surface



(Unit: mm)

Model	Distance	A	B	C
E2S-W1□	0	0	8	2
E2S-W2□			15	10

- Models with Front Sensing Surface



(Unit: mm)

Model	Distance	A	B	C
E2S-Q1□	8	3	2	
E2S-Q2□	15	10	3	

Applicable e-CON Connector Models and Manufacturers

The companies and model number of e-CON connections that can be used with Sensor cables are listed in the following table. Confirm applicability when purchasing e-CON connectors for connection to Pre-wired Sensors.

Model	Applicable e-CON Connector	Manufacturer
E2S-W□3/4	XN2A-1470 Cable Plug Connector	OMRON
E2S-Q□3/4		

Mutual Interference

When installing Sensors face-to-face or side-by-side, ensure that the minimum distances given in the following table are maintained.

- Models with Top Sensing Surface
- Models with Front Sensing Surface



(Unit: mm)

Model	Distance	A	B
E2S-W(Q)1□	50 (40) *1	20 (5.5) *1, *2	
E2S-W(Q)2□	75 (50) *1	25 (8) *1, *2	

*1. Values in parentheses apply to Sensors operating at different frequencies.
*2. Mutual interference will not occur for close-proximity mounting if models with different frequencies are used together.

● **Mounting**

Tightening Torque

For the E2S-W(Q)2□, the maximum tightening torque that should be applied to the mounting screws is 0.7 N·m.

Dimensions

Tolerance class IT16 applies to dimensions in this data sheet unless otherwise specified.

Sensors

E2S-W1 □

With Mounting Bracket Attached



E2S-Q1 □

With Mounting Bracket Attached



E2S-W2 □

With Mounting Bracket Attached



E2S-Q2 □

With Mounting Bracket Attached



Accessories (Order Separately)

Mounting Bracket
Y92E-C1R6

Material: Stainless steel (SUS304)

* Provided with E2S-□1□□.



Mounting Bracket
Y92E-C2R5

Material: Stainless steel (SUS304)

* Provided with E2S-□2□□.

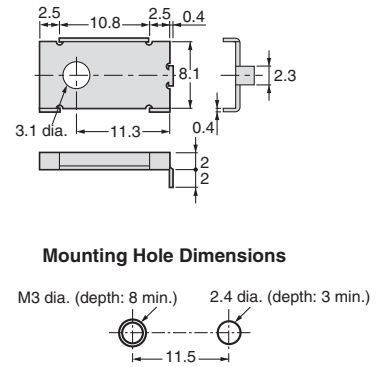

Mounting Bracket
Y92E-D1R6

Material: Stainless steel (SUS304)

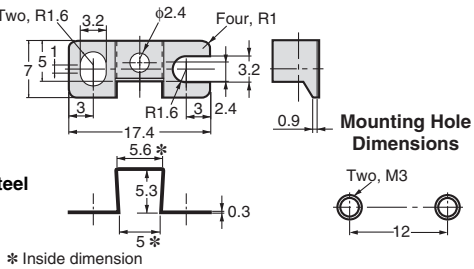

Mounting Bracket
Y92E-D2R5

Material: Stainless steel (SUS304)

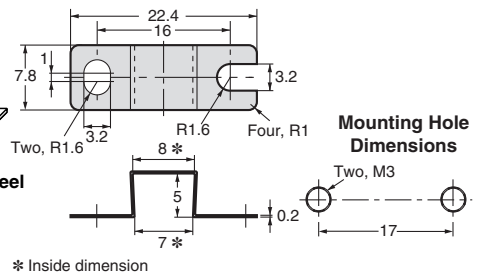

Terms and Conditions Agreement

Read and understand this catalog.

Please read and understand this catalog before purchasing the products. Please consult your OMRON representative if you have any questions or comments.

Warranties.

(a) Exclusive Warranty. Omron's exclusive warranty is that the Products will be free from defects in materials and workmanship for a period of twelve months from the date of sale by Omron (or such other period expressed in writing by Omron). Omron disclaims all other warranties, express or implied.

(b) Limitations. OMRON MAKES NO WARRANTY OR REPRESENTATION, EXPRESS OR IMPLIED, ABOUT NON-INFRINGEMENT, MERCHANTABILITY OR FITNESS FOR A PARTICULAR PURPOSE OF THE PRODUCTS. BUYER ACKNOWLEDGES THAT IT ALONE HAS DETERMINED THAT THE PRODUCTS WILL SUITABLY MEET THE REQUIREMENTS OF THEIR INTENDED USE.

Omron further disclaims all warranties and responsibility of any type for claims or expenses based on infringement by the Products or otherwise of any intellectual property right. (c) Buyer Remedy. Omron's sole obligation hereunder shall be, at Omron's election, to (i) replace (in the form originally shipped with Buyer responsible for labor charges for removal or replacement thereof) the non-complying Product, (ii) repair the non-complying Product, or (iii) repay or credit Buyer an amount equal to the purchase price of the non-complying Product; provided that in no event shall Omron be responsible for warranty, repair, indemnity or any other claims or expenses regarding the Products unless Omron's analysis confirms that the Products were properly handled, stored, installed and maintained and not subject to contamination, abuse, misuse or inappropriate modification. Return of any Products by Buyer must be approved in writing by Omron before shipment. Omron Companies shall not be liable for the suitability or unsuitability or the results from the use of Products in combination with any electrical or electronic components, circuits, system assemblies or any other materials or substances or environments. Any advice, recommendations or information given orally or in writing, are not to be construed as an amendment or addition to the above warranty.

See <http://www.omron.com/global/> or contact your Omron representative for published information.

Limitation on Liability; Etc.

OMRON COMPANIES SHALL NOT BE LIABLE FOR SPECIAL, INDIRECT, INCIDENTAL, OR CONSEQUENTIAL DAMAGES, LOSS OF PROFITS OR PRODUCTION OR COMMERCIAL LOSS IN ANY WAY CONNECTED WITH THE PRODUCTS, WHETHER SUCH CLAIM IS BASED IN CONTRACT, WARRANTY, NEGLIGENCE OR STRICT LIABILITY.

Further, in no event shall liability of Omron Companies exceed the individual price of the Product on which liability is asserted.

Suitability of Use.

Omron Companies shall not be responsible for conformity with any standards, codes or regulations which apply to the combination of the Product in the Buyer's application or use of the Product. At Buyer's request, Omron will provide applicable third party certification documents identifying ratings and limitations of use which apply to the Product. This information by itself is not sufficient for a complete determination of the suitability of the Product in combination with the end product, machine, system, or other application or use. Buyer shall be solely responsible for determining appropriateness of the particular Product with respect to Buyer's application, product or system. Buyer shall take application responsibility in all cases.

NEVER USE THE PRODUCT FOR AN APPLICATION INVOLVING SERIOUS RISK TO LIFE OR PROPERTY OR IN LARGE QUANTITIES WITHOUT ENSURING THAT THE SYSTEM AS A WHOLE HAS BEEN DESIGNED TO ADDRESS THE RISKS, AND THAT THE OMRON PRODUCT(S) IS PROPERLY RATED AND INSTALLED FOR THE INTENDED USE WITHIN THE OVERALL EQUIPMENT OR SYSTEM.

Programmable Products.

Omron Companies shall not be responsible for the user's programming of a programmable Product, or any consequence thereof.

Performance Data.

Data presented in Omron Company websites, catalogs and other materials is provided as a guide for the user in determining suitability and does not constitute a warranty. It may represent the result of Omron's test conditions, and the user must correlate it to actual application requirements. Actual performance is subject to the Omron's Warranty and Limitations of Liability.

Change in Specifications.

Product specifications and accessories may be changed at any time based on improvements and other reasons. It is our practice to change part numbers when published ratings or features are changed, or when significant construction changes are made. However, some specifications of the Product may be changed without any notice. When in doubt, special part numbers may be assigned to fix or establish key specifications for your application. Please consult with your Omron's representative at any time to confirm actual specifications of purchased Product.

Errors and Omissions.

Information presented by Omron Companies has been checked and is believed to be accurate; however, no responsibility is assumed for clerical, typographical or proofreading errors or omissions.

2015.9

In the interest of product improvement, specifications are subject to change without notice.

OMRON Corporation
Industrial Automation Company

<http://www.ia.omron.com/>

(c)Copyright OMRON Corporation 2015 All Right Reserved.

Mouser Electronics

Authorized Distributor

Click to View Pricing, Inventory, Delivery & Lifecycle Information:

Omron:

[E2S-Q11 1M](#) [E2S-Q12 1M](#) [E2S-Q13B 1M](#) [E2S-Q23B 1M](#) [E2S-Q24 1M](#) [E2S-W11B 1M](#) [E2S-W21B 5M](#) [E2S-Q15](#)
[5M](#) [E2S-W15B 1M](#) [E2S-W25 5M](#)

Компания «Океан Электроники» предлагает заключение долгосрочных отношений при поставках импортных электронных компонентов на взаимовыгодных условиях!

Наши преимущества:

- Поставка оригинальных импортных электронных компонентов напрямую с производств Америки, Европы и Азии, а так же с крупнейших складов мира;
- Широкая линейка поставок активных и пассивных импортных электронных компонентов (более 30 млн. наименований);
- Поставка сложных, дефицитных, либо снятых с производства позиций;
- Оперативные сроки поставки под заказ (от 5 рабочих дней);
- Экспресс доставка в любую точку России;
- Помощь Конструкторского Отдела и консультации квалифицированных инженеров;
- Техническая поддержка проекта, помощь в подборе аналогов, поставка прототипов;
- Поставка электронных компонентов под контролем ВП;
- Система менеджмента качества сертифицирована по Международному стандарту ISO 9001;
- При необходимости вся продукция военного и аэрокосмического назначения проходит испытания и сертификацию в лаборатории (по согласованию с заказчиком);
- Поставка специализированных компонентов военного и аэрокосмического уровня качества (Xilinx, Altera, Analog Devices, Intersil, Interpoint, Microsemi, Actel, Aeroflex, Peregrine, VPT, Syfer, Eurofarad, Texas Instruments, MS Kennedy, Miteq, Cobham, E2V, MA-COM, Hittite, Mini-Circuits, General Dynamics и др.);

Компания «Океан Электроники» является официальным дистрибьютором и эксклюзивным представителем в России одного из крупнейших производителей разъемов военного и аэрокосмического назначения «JONHON», а так же официальным дистрибьютором и эксклюзивным представителем в России производителя высокотехнологичных и надежных решений для передачи СВЧ сигналов «FORSTAR».



JONHON

«JONHON» (основан в 1970 г.)

Разъемы специального, военного и аэрокосмического назначения:

(Применяются в военной, авиационной, аэрокосмической, морской, железнодорожной, горно- и нефтедобывающей отраслях промышленности)

«FORSTAR» (основан в 1998 г.)

ВЧ соединители, коаксиальные кабели, кабельные сборки и микроволновые компоненты:

(Применяются в телекоммуникациях гражданского и специального назначения, в средствах связи, РЛС, а так же военной, авиационной и аэрокосмической отраслях промышленности).



Телефон: 8 (812) 309-75-97 (многоканальный)

Факс: 8 (812) 320-03-32

Электронная почта: ocean@oceanchips.ru

Web: <http://oceanchips.ru/>

Адрес: 198099, г. Санкт-Петербург, ул. Калинина, д. 2, корп. 4, лит. А