

HFBR-1506AFZ/HFBR-2506AFZ

Full Metal Fiber Optic SMA Transmitters and Receivers for 16 MBd SERCOS Applications



Data Sheet



Description

SERCOS, an acronym for **S**ERial **R**ealtime **C**ommunications **S**ystems, is a standard digital interface for communication in industrial CNC applications. SERCOS is a European (EN 61491) and international standard (IEC 61491). The optical interface allows data rates of 2,4,8 and 16 MBd and data transfer between numerical controls and drives via fiber-optic rings, with voltage isolation and noise immunity. The HFBR-1506AFZ and HFBR-2506AFZ products have a guaranteed performance up to 16 MBd.

Features

- RoHS-Compliant
- Meets Industrial SERCOS 16MBd standard
- SMA ports
- 650 nm wavelength
- Metal housing and port
- Specified for use with 1 mm POF and 200 μ m HCS
- DC - 16 MBd data rate

Applications

- Industrial Control Data Links
- Factory Automation Data Links
- Voltage Isolation Applications

Package Information

The RoHS-compliant transmitters and receivers are housed in a metal package that is high strength. Both the transmitter and receiver are built with metal housings and optical ports for excellence air discharge (ESD) performance. The package is designed for auto insertion and wave soldering so it is ideal for high volume production applications.

Handling and Design Information

When soldering, it is advisable to leave the protective cap on the unit to keep the optics clean. Good system performance requires clean port optics and cable ferrules to avoid obstructing the optical path. Clean compressed air often is sufficient to remove particles of dirt; methanol on a cotton swab also works well.

Recommended Chemicals for Cleaning/Degreasing

Alcohols: methyl, isopropyl, isobutyl.

Aliphatics: hexane, heptane.

Other: soap solution, naphtha.

Do not use partially halogenated hydrocarbons such as 1,1,1 trichloroethane, ketones such as MEK, acetone, chloroform, ethyl acetate, methylene dichloride, phenol, methylene chloride or N-methylpyrrolidone. Also, Avago Technologies does not recommend the use of cleaners that use halogenated hydrocarbons because of their potential environmental harm.

CAUTION: The small junction size inherent in the design of these components increases the components' susceptibility to damage from electrostatic discharge (ESD). It is advised that normal static precautions be taken in handling and assembly of these components to prevent damage and/or degradation which may be induced by ESD.

Table 1. Link Performance Specification

-40 °C to +85 °C unless otherwise noted.

Parameter	Symbol	Min	Max	Unit	Condition	Reference
Link distance with HFBR-1506AFZ/2506AFZ	l	0.1	45	mm	POF	Note 1, 2, 4, 6
		0.1	100		HCS	Note 1, 3, 5, 6

Notes:

1. 60 mA nominal drive current.
2. POF HFBR-ExxyyyZ 0.23 dB/m worst case attenuation.
3. HCS Worst Case Attenuation is 10dB/km (0°C to 70°C) and 12dB/km (-40°C to 85°C).
4. Including a 3 dB optical safety margin accounting for link service lifetime.
5. Including a 2 dB optical safety margin accounting for link service lifetime.
6. Signaling rate dc to 16 MBd.

HFBR-1506AFZ Transmitter

The HFBR-1506AFZ transmitter incorporates a 650nm LED in a metal housing. The high light output power enables the use of both plastic optical fiber (POF) and Hard Clad Silica (HCS). This transmitter can operate up to 16MBd using a simple driver circuit. The HFBR-1506AFZ is compatible with SMA connectors.

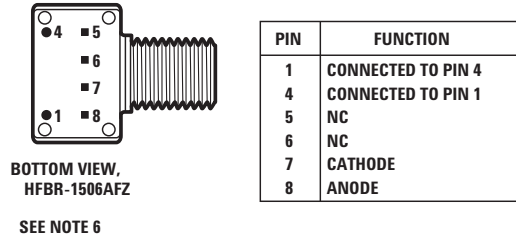

Figure 1.

Absolute Maximum Ratings

Parameter	Symbol	Min	Max	Unit	Notes
Storage and Operating Temperature	$T_{S, O}$	-40	+85	°C	
Peak Forward Input Current	$I_{F, PK}$		90	mA	1
Average Forward Input Current	$I_{F, AVG}$		60	mA	
Reverse Input Voltage	V_R		3	V	
Lead Soldering Cycle					
Temp	T_{SOL}		260	°C	2, 3
Time	T_{SOL}		10	s	

Notes:

- For $I_{F, PK} > 60$ mA, the duty factor must maintain $I_{F, AVG} \leq 60$ mA and pulse width ≤ 1 μ s.
- 1.6 mm below seating plane.
- Moisture sensitivity level (MSL) is 3

Electrical Characteristics Table

-40 °C to +85 °C unless otherwise noted.

Parameter	Symbol	Min	Typ	Max	Unit	Condition	Notes
Optical Power Temperature Coefficient	$\Delta P_T / \Delta T$		-0.02		dB/°C		Note 3
Forward Voltage	V_F	1.8	2.1	2.65	V	$I_{F, dc} = 60$ mA	See Figure 2
Forward Voltage Temperature Coefficient	$\Delta V_F / \Delta T$		-1.8		mV/°C		See Figure 2
Breakdown Voltage	V_{BR}	3.0	13		V	$I_{F, dc} = -10$ μ A	
Peak Emission Wavelength	λ_{PK}	635	650	662	nm		See Figure 4
Full Width Half Max	FWHM		21	30	nm		See Figure 4
Diode Capacitance	C_O		60		pF	$V_F = 0$ V, $f = 1$ MHz	
Thermal Resistance	θ_{JC}		140		°C/W		Notes 4, 5
Rise Time (10% to 90%)	t_r			15	ns	10% to 90% $I_F = 60$ mA	See Figure 6
Fall Time (90% to 10%)	t_f			15	ns		See Figure 6

Notes:

- Typical data are at +25 °C
- Thermal resistance is measured with the transmitter coupled to a connector assembly and fiber, and mounted on a printed circuit board.
- To further reduce the thermal resistance, the cathode trace should be made as large as is consistent with good RF circuit design.
- Pins 1 and 4 are for mounting and retaining purposes, but are electrically connected, pins 5 and 6 are electrically isolated. It is recommended that pins 1, 4, 5 and 6 all be connected to ground to reduce coupling of electrical noise.

Peak Output Power

-40 °C to +85 °C unless otherwise noted.

Model Number	Symbol	Min	Max	Unit	Condition	Reference
HFBR-1506AFZ	Pr	-6.0	-2.0	dBm	POF, $I_{F,dc} = 60 \text{ mA}$	Note 7
		-18.0	-10.0		HCS [®] , $I_{F,dc} = 60 \text{ mA}$	Figure 3

Notes:

- Optical power measured at the end of 1 meters of 1 mm diameter plastic or 200 μm hard/plastic clad silica optical fiber with a large area detector.

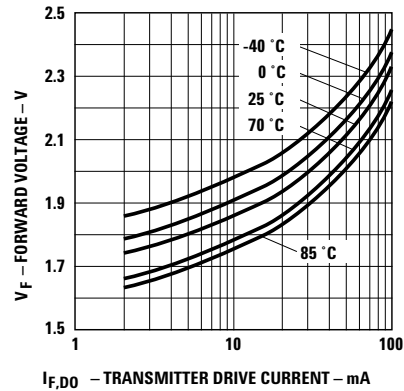

Figure 2. Typical Forward Voltage vs Drive Current

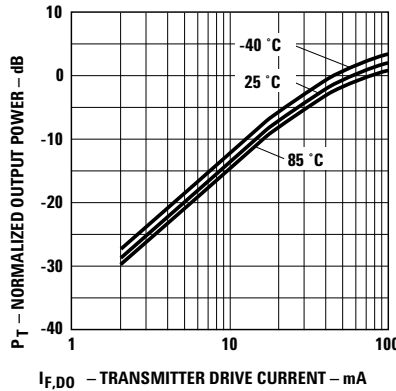

Figure 3. Typical Normalized Optical Power vs Drive Current

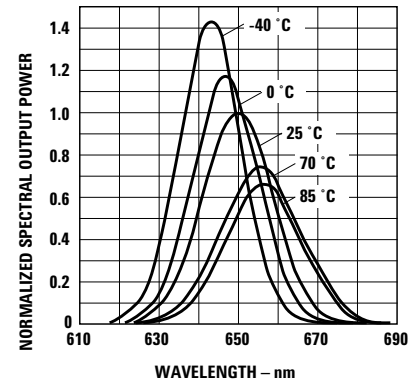

Figure 4. Typical Normalized Optical Spectra

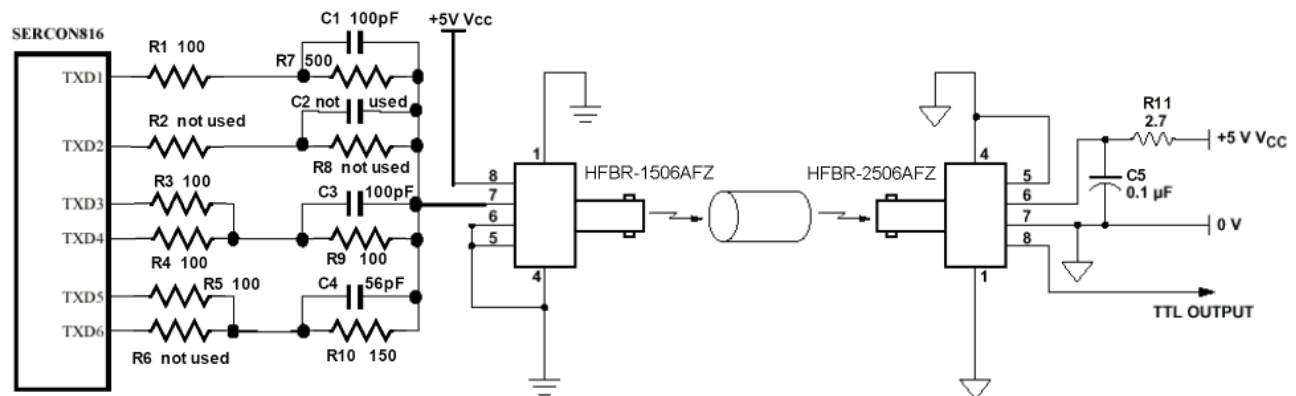
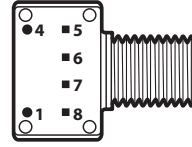

Figure 5. Recommended drive circuit according to SERCOS An17 ($I_{fnom} \sim 35 \text{ mA}$)

HFBR-2506AFZ Receiver

The HFBR-2506AFZ receiver is housed in a metal package, consisting of a silicon PIN photodiode and digitizing IC to produce a logic compatible output. The IC includes a unique circuit to correct the pulse width distortion of the first bit after a long idle period. This enables operation from DC to 16MBd with low PWD for arbitrary data patterns.

The receiver is a “push-pull” stage compatible with TTL and CMOS logic. The HFBR-2506AFZ is compatible with SMA connectors.



BOTTOM VIEW,
HFBR-2506AFZ

SEE NOTE 4

PIN	FUNCTION
1	CONNECTED TO PIN 4
4	CONNECTED TO PIN 1
5	NO CONNECT
6	VCC
7	GND
8	VO

Figure 6.

Absolute Maximum Ratings

Parameter	Symbol	Min	Max	Unit	Notes
Storage and Operating Temperature	$T_{S,O}$	-40	+85	°C	
Supply Voltage	V_{CC}	-0.5	5.5	V	
Average Output Current	$I_{O,AVG}$		16	mA	
Output Power Dissipation	P_{OD}		80	mW	
Lead Soldering Cycle					
Temp	T_{SOL}		260	°C	1, 5
Time	T_{SOL}		10	s	

Electrical Characteristics Table

-40 °C to +85 °C, 4.75 V < V_{CC} < 5.25 V, V_{P-P} Noise < = 100 mV unless otherwise noted.

Parameter	Symbol	Min	Typ	Max	Unit	Condition	Notes
Peak Input Power Level Logic HIGH	P_{RH}			-42 -44	dBm	1 mm POF 200 μ m HCS	2
Peak Input Power Level Logic LOW	P_{RL}	-20 -22		-2 -10	dBm	1 mm POF 200 μ m HCS PWD < 19 ns	3
Supply Current	I_{CC}		19	45	mA	V_O = Open	
High Level Output Voltage	V_{OH}	4.2	4.7		V	I_O = 40 μ A	
Low Level Output Voltage	V_{OH}		0.22	0.4	V	I_O = 1.6 mA	
Pulse Width Distortion	PWD	-19		19	ns		
Propagation Delay Time	$T_{P,HL}$ or $_{LH}$			150	ns		

Notes:

- 1.6 mm below seating plane.
- Typical data are at +25 °C, V_{CC} = 5.0 V
- BER < = $10E^{-9}$, includes a 10.8 dB margin below the receiver switching threshold level (signal to noise ratio =12)
- Pins 1 and 4 are electrically connected to the metal housing and are also used for mounting and retaining purposes. It is recommended that pins 1 and 4 to be connected to ground to maintain housing shield effectiveness.
- Moisture sensitivity level (MSL) is 3

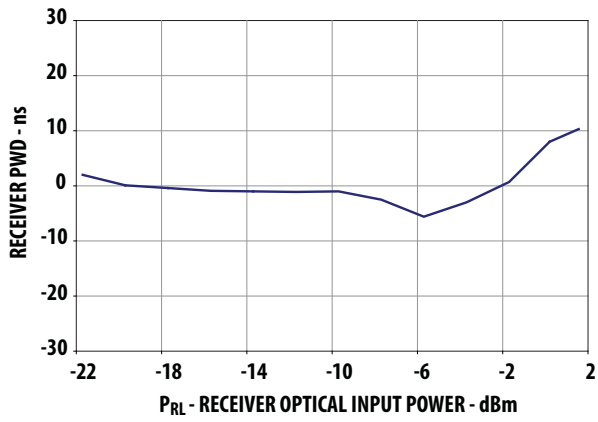

Figure 7. Typical POF receiver pulse width distortion vs optical power

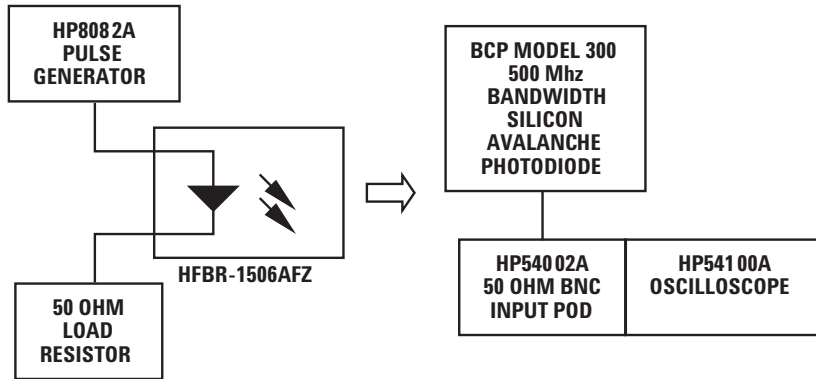
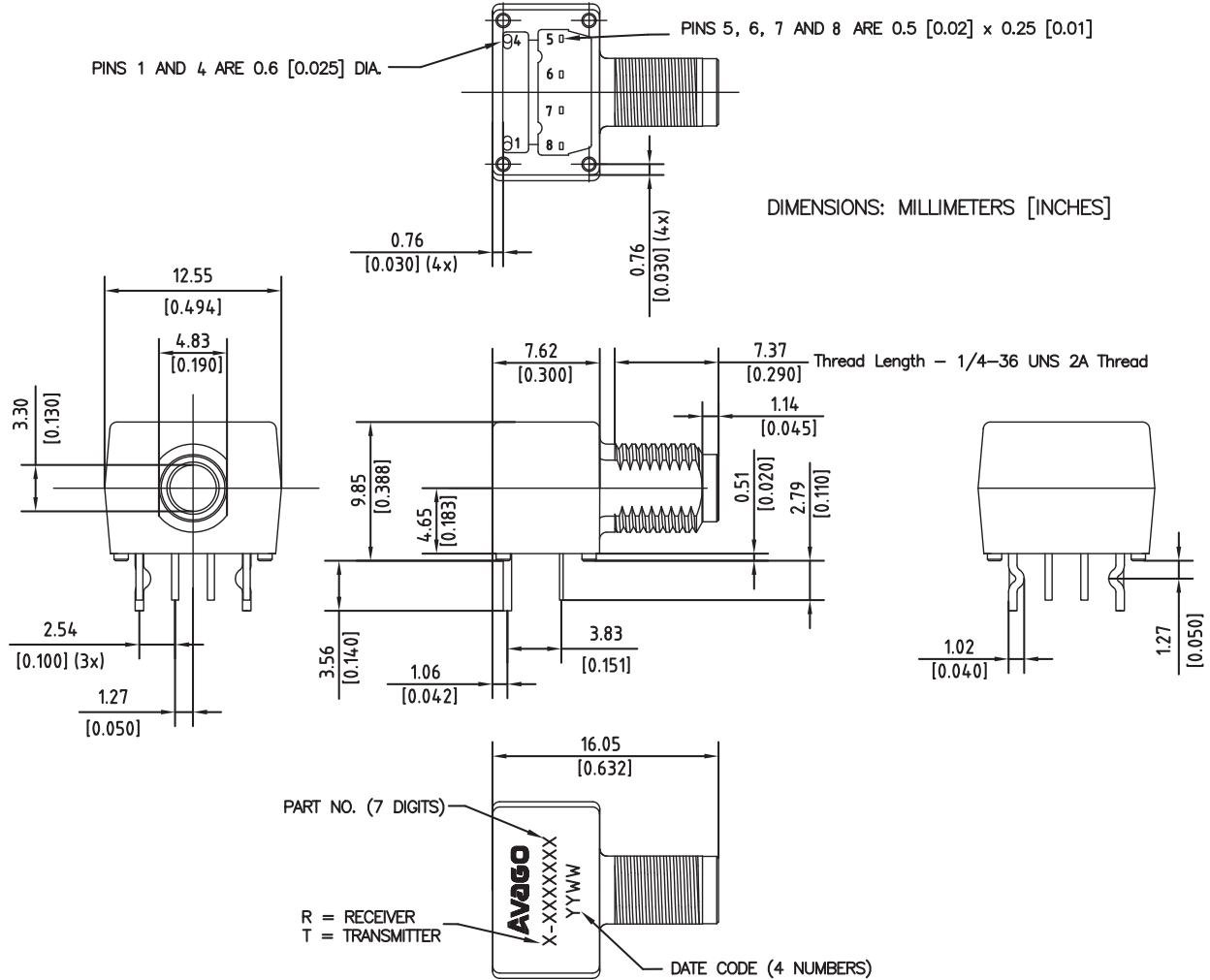

Figure 8. Test Circuit for Measuring Unpeaked Rise and Fall Times

Mechanical Dimensions

HFBR-X506AFZ



For product information and a complete list of distributors, please go to our web site: www.avagotech.com

Avago, Avago Technologies, and the A logo are trademarks of Avago Technologies in the United States and other countries.
Data subject to change. Copyright © 2005-2011 Avago Technologies. All rights reserved.
AV02-1412EN - November 4, 2011



Specifications and content subject to change without prior notification.

Компания «Океан Электроники» предлагает заключение долгосрочных отношений при поставках импортных электронных компонентов на взаимовыгодных условиях!

Наши преимущества:

- Поставка оригинальных импортных электронных компонентов напрямую с производств Америки, Европы и Азии, а так же с крупнейших складов мира;
- Широкая линейка поставок активных и пассивных импортных электронных компонентов (более 30 млн. наименований);
- Поставка сложных, дефицитных, либо снятых с производства позиций;
- Оперативные сроки поставки под заказ (от 5 рабочих дней);
- Экспресс доставка в любую точку России;
- Помощь Конструкторского Отдела и консультации квалифицированных инженеров;
- Техническая поддержка проекта, помощь в подборе аналогов, поставка прототипов;
- Поставка электронных компонентов под контролем ВП;
- Система менеджмента качества сертифицирована по Международному стандарту ISO 9001;
- При необходимости вся продукция военного и аэрокосмического назначения проходит испытания и сертификацию в лаборатории (по согласованию с заказчиком);
- Поставка специализированных компонентов военного и аэрокосмического уровня качества (Xilinx, Altera, Analog Devices, Intersil, Interpoint, Microsemi, Actel, Aeroflex, Peregrine, VPT, Syfer, Eurofarad, Texas Instruments, MS Kennedy, Miteq, Cobham, E2V, MA-COM, Hittite, Mini-Circuits, General Dynamics и др.);

Компания «Океан Электроники» является официальным дистрибьютором и эксклюзивным представителем в России одного из крупнейших производителей разъемов военного и аэрокосмического назначения «JONHON», а так же официальным дистрибьютором и эксклюзивным представителем в России производителя высокотехнологичных и надежных решений для передачи СВЧ сигналов «FORSTAR».



JONHON

«JONHON» (основан в 1970 г.)

Разъемы специального, военного и аэрокосмического назначения:

(Применяются в военной, авиационной, аэрокосмической, морской, железнодорожной, горно- и нефтедобывающей отраслях промышленности)

«FORSTAR» (основан в 1998 г.)

ВЧ соединители, коаксиальные кабели, кабельные сборки и микроволновые компоненты:

(Применяются в телекоммуникациях гражданского и специального назначения, в средствах связи, РЛС, а так же военной, авиационной и аэрокосмической отраслях промышленности).



Телефон: 8 (812) 309-75-97 (многоканальный)

Факс: 8 (812) 320-03-32

Электронная почта: ocean@oceanchips.ru

Web: <http://oceanchips.ru/>

Адрес: 198099, г. Санкт-Петербург, ул. Калинина, д. 2, корп. 4, лит. А