

TABLE OF CONTENTS



MINIATURE

Mini fuses in five sizes to 20 Amps.

- Slow Blow
- Medium Blow
- Fast Blow
- Super Fast Blow

Fuses 4-5

DIAZED

"Bottle" fuses in five sizes to 200 Amps.

- gL/gG - Slow Blow
- Fast Blow
- gR - Semiconductor Protection

Fuses 6-7
Accessories 10-11

NEOZED

Compact fuses in three sizes to 100 Amps.

- gL/gG - Slow Blow
- gR - Semiconductor Protection

Fuses 8-9
Accessories 10-11

CYLINDER

Standard cylinder fuses are available in four sizes to 125 Amps, with or without blown fuse Indicator Pins.

- gl/gF - Line Protection
- aM - Motor Protection
- gR - Semiconductor Protection

Cylinder Bolt fuses are available in two diameters with multiple fixing centers.

- gR - Semiconductor Protection

Fuses - Standard 12-13
Fuses - Bolt 14
Accessories 15

NH

Knife Blade or Stud Mount designs in six sizes with current ratings of 2 to 1600 Amps.

- gL/gG - Line Protection
- aM - Motor Protection
- gR/aR - Semiconductor Protection

Fuses 16-21
Accessories 19



ITALIAN

Cylinder style fuses available in four sizes with current ratings from 2 to 100 Amps.

- gl - Line Protection

No Longer Available

Fuses 22

BRITISH

British Line Protection fuses are available with four mounting plate designs with current ratings from 2 to 63 Amps.

- gG - Line Protection
- gR - Semiconductor Protection
- aR - Semiconductor Protection

Fuses - Line 23
Fuses - Semi. 24-25

SQUARE BODY

Square body fuses for semiconductor devices to 1000 Amps.

- aR - Semiconductor Protection

Non Stocked By request only.

Fuses 26-31
Accessories 19

HIGH VOLTAGE

Fuses for distribution circuits in four sizes to 36KV.

Fuses 32-33

ACCESSORIES

- Screw Caps
- Adapter Screws and Rings
- Fuse Base Covers
- Fuse Bases
- Tools
- End Plates
- Microswitches
- Terminal Covers
- Fuse Handles

10-11, 15, 19

Siemens Cross Reference 34-35

MINIATURE

Miniature Fuses are typically used to protect electronic devices, laboratory and measurement instruments, stereos, TV's, VCR's etc. They are available in four sizes with a current range of 20mA to 20 Amps.

Miniature Fuses are manufactured according to VDE 0820 part 1, VDE 0820 part 2, IEC publication 127, CEE publication 4 and actual DIN standards.

Slow

Typical Marking: "T"

Medium

Typical Marking: "M"

Fast

Typical Marking: "F"

Super Fast

Typical Marking: "FF"



5 x 20



5 x 25

| Ordering Information | Voltage 250V DIN 41662 IEC-127-2/III | | | Voltage 250V DIN 41571-2 | |
|----------------------|--|-------------|--------------------------|-----------------------------|--|
| | DIN 41571-2 | | | DIN 41661 IEC-127-2/II | |
| | Cat. No. | | | Cat. No. | |
| Current | Slow | Medium | Fast | Medium | |
| 20mA | | 0.02M5x20M | | 0.032M5x25M | |
| 32mA | | 0.032M5x20M | | 0.04M5x25M | |
| 40mA | | | | 0.05M5x25M | |
| 50mA | 0.05M5x20T ⁴ | 0.05M5x20M | 0.05M5x20F ⁴ | 0.063M5x25M | |
| 63mA | | 0.063M5x20M | | 0.08M5x25M | |
| 80mA | 0.08M5x20T ⁴ | 0.08M5x20M | | 0.1M5x25M | |
| 100mA | 0.1M5x20T ⁴ | 0.1M5x20M | 0.1M5x20F ⁴ | 0.125M5x25M | |
| 125mA | 0.125M5x20T ⁴ | 0.125M5x20M | 0.125M5x20F ⁴ | 0.16M5x25M | |
| 160mA | 0.16M5x20T ⁴ | 0.16M5x20M | 0.16M5x20F ⁴ | 0.2M5x25M | |
| 200mA | 0.2M5x20T ⁴ | 0.2M5x20M | 0.2M5x20F ⁴ | 0.25M5x25M | |
| 250mA | 0.25M5x20T ⁴ | 0.25M5x20M | 0.25M5x20F ⁴ | 0.315M5x25M | |
| 315mA | 0.315M5x20T ⁴ | 0.315M5x20M | 0.315M5x20F ⁴ | | |
| 400mA | 0.4M5x20T ⁴ | 0.4M5x20M | 0.4M5x20F ⁴ | 0.4M5x25M | |
| 500mA | 0.5M5x20T ⁴ | 0.5M5x20M | 0.5M5x20F ⁴ | 0.5M5x25M | |
| 630mA | 0.63M5x20T ⁴ | 0.63M5x20M | 0.63M5x20F ⁴ | 0.63M5x25M | |
| 700mA | 0.7M5x20T | 0.7M5x20M | 0.7M5x20F | | |
| 800mA | 0.8M5x20T ⁴ | 0.8M5x20M | 0.8M5x20F ⁴ | 0.8M5x25M | |
| 1.0A | 1.0M5x20T ⁴ | 1.0M5x20M | 1.0M5x20F ⁴ | 1.0M5x25M | |
| 1.25A | 1.25M5x20T ⁴ | 1.25M5x20M | 1.25M5x20F ⁴ | 1.25M5x25M | |
| 1.4A | 1.4M5x20T | 1.4M5x20M | | | |
| 1.6A | 1.6M5x20T ⁴ | 1.6M5x20M | 1.6M5x20F ⁴ | 1.6M5x25M | |
| 2.0A | 2.0M5x20T ⁴ | 2.0M5x20M | 2.0M5x20F ⁴ | 2.0M5x25M | |
| 2.5A | 2.5M5x20T ⁴ | 2.5M5x20M | 2.5M5x20F ⁴ | 2.5M5x25M | |
| 3.15A | 3.15M5x20T ⁴ | 3.15M5x20M | 3.15M5x20F ⁴ | 3.15M5x25M | |
| 4.0A | 4.0M5x20T ⁴ | 4.0M5x20M | 4.0M5x20F ⁴ | 4.0M5x25M | |
| 5.0A | 5.0M5x20T ⁴ | 5.0M5x20M | 5.0M5x20F ⁴ | 5.0M5x25M | |
| 6.3A | 6.3M5x20T ⁴ | 6.3M5x20M | 6.3M5x20F ⁴ | 6.3M5x25M | |
| 7.0A | | | | | |
| 8.0A | 8.0M5x20T* | 8.0M5x20M | 8.0M5x20F* | 8.0M5x25M * | |
| 10.0A | 10.0M5x20T* | 10.0M5x20M | 10.0M5x20F* | 10.0M5x25M * | |
| 12.5A | 12.5M5x20T* | 12.5M5x20M* | 12.5M5x20F* | | |
| 16.0A | 16.0M5x20T* | 16.0M5x20M* | 16.0M5x20F* | 16.0M5x25M * | |
| 20.0A | 20.0M5x20T* | 20.0M5x20M* | 20.0M5x20F* | | |

Std. Pk. 10

Std. Pk. 10

All fuses listed are low breaking capacity. For high breaking capacity fuses please contact Altech.

* Not standard rating.
¹ Rated Voltage 500V.
² Rated Voltage 150V.
³ Rated Voltage 60V.

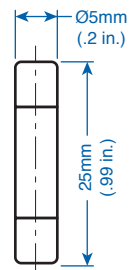
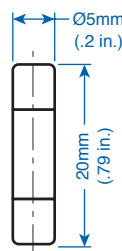



**5 x 25
with Indicator**

Voltage 250V
DIN 41576-1, -2

| Cat. No. | |
|---------------|------|
| Medium | Fast |
| 0.08M5x25M/I | |
| 0.1M5x25M/I | |
| 0.125M5x25M/I | |
| 0.16M5x25M/I | |
| 0.2M5x25M/I | |
| 0.25M5x25M/I | |
| 0.315M5x25M/I | |

| | |
|--------------|-------------|
| 0.4M5x25M/I | |
| 0.5M5x25M/I | |
| 0.63M5x25M/I | |
| 0.8M5x25M/I | |
| 1.0M5x25M/I | |
| 1.25M5x25M/I | |
| 1.6M5x25M/I | 1.6M5x25F/I |
| 2.0M5x25M/I | 2.0M5x25F/I |
| 2.5M5x25M/I | 2.5M5x25F/I |

| | |
|---------------|---------------|
| 3.15M5x25M/I | 3.15M5x25F/I |
| 4.0M5x25M/I | 4.0M5x25F/I |
| 5.0M5x25M/I | 5.0M5x25F/I |
| 6.3M5x25M/I | 6.3M5x25F/I |
| 8.0M5x25M/I* | 8.0M5x25F/I* |
| 10.0M5x25M/I* | 10.0M5x25F/I* |

Std. Pk. 10

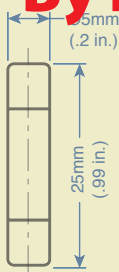

5 x 30

Voltage 500V
DIN 41571-2

| Cat. No. |
|-------------|
| Medium |
| 0.032M5x30M |
| 0.04M5x30M |
| 0.05M5x30M |
| 0.063M5x30M |
| 0.08M5x30M |
| 0.1M5x30M |
| 0.125M5x30M |
| 0.16M5x30M |
| 0.2M5x30M |
| 0.25M5x30M |
| 0.315M5x30M |

| |
|------------|
| 0.4M5x30M |
| 0.5M5x30M |
| 0.63M5x30M |
| 0.8M5x30M |
| 1.0M5x30M |
| 1.25M5x30M |
| 1.6M5x30M |
| 2.0M5x30M |
| 2.5M5x30M |

| |
|-------------|
| 3.15M5x30M |
| 4.0M5x30M |
| 5.0M5x30M |
| 6.3M5x30M |
| 8.0M5x30M* |
| 10.0M5x30M* |
| 16.0M5x30M* |

Std. Pk. 10

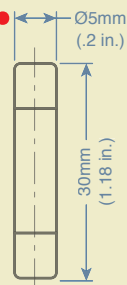

6.3 x 32

Voltage 250V

| Cat. No. | |
|----------------------------|---------------|
| Slow | Fast |
| 0.032M6.3x32T ⁴ | |
| 0.04M6.3x32T ⁴ | |
| 0.05M6.3x32T ⁴ | 0.05M6.3x32F |
| 0.063M6.3x32T ⁴ | 0.063M6.3x32F |
| 0.08M6.3x32T ⁴ | 0.08M6.3x32F |
| 0.1M6.3x32T ⁴ | 0.1M6.3x32F |
| 0.125M6.3x32T ⁴ | 0.125M6.3x32F |
| 0.16M6.3x32T ⁴ | 0.16M6.3x32F |
| 0.2M6.3x32T ⁴ | 0.2M6.3x32F |
| 0.25M6.3x32T ⁴ | 0.25M6.3x32F |
| 0.315M6.3x32T ⁴ | 0.315M6.3x32F |

| | |
|---------------------------|----------------------------|
| 0.4M6.3x32T ⁴ | 0.4M6.3x32F |
| 0.5M6.3x32T ⁴ | 0.5M6.3x32F |
| 0.63M6.3x32T ⁴ | 0.63M6.3x32F |
| 0.7M6.3x32T | 0.7M6.3x32F |
| 0.8M6.3x32T ⁴ | 0.8M6.3x32F |
| 1.0M6.3x32T ⁴ | 1.0M6.3x32F ⁴ |
| 1.25M6.3x32T ⁴ | 1.25M6.3x32F ⁴ |
| 1.6M6.3x32T ⁴ | 1.6M6.3x32F ⁴ |
| 2.0M6.3x32T ⁴ | 2.0M6.3x32F ⁴ |
| 2.5M6.3x32T ⁴ | 2.5M6.3x32F ^{2,4} |

| | |
|---------------------------|-----------------------------|
| 3.15M6.3x32T ⁴ | 3.15M6.3x32F ^{2,4} |
| 4.0M6.3x32T ⁴ | 4.0M6.3x32F ^{2,4} |
| 5.0M6.3x32T ⁴ | 5.0M6.3x32F ^{3,4} |
| 6.3M6.3x32T ⁴ | 6.3M6.3x32F ^{3,4} |
| 7.0M6.3x32T | 7.0M6.3x32F ³ |
| 8.0M6.3x32T | 8.0M6.3x32F ³ |
| 10.0M6.3x32T | 10.0M6.3x32F ³ |
| 12.5M6.3x32T | 12.5M6.3x32F ³ |
| 16.0M6.3x32T | 16.0M6.3x32F ³ |
| 20.0M6.3x32T | 20.0M6.3x32F ³ |

Std. Pk. 10

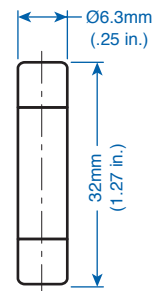

**Non Stocked
By request only.**

DIAZED (BOTTLE)

Diazed Fuses, commonly called "Bottle" Fuses, are available in five sizes, ND to 35 Amps, DII to 35 Amps, DIII to 100 Amps, DIV to 100 Amps and DV to 200 Amps. Fuse accessories are sized to match. Each size fuse body has a different diameter to fit only into the appropriate Screw Cap and Fuse Base. (See illustration pg 10.)

Also, the fuse tips have different diameters, depending on their current rating. The diameter of the tip matches the diameter of the hole in the Adapter Screw to insure that no fuse with a higher rating than intended for the circuit can be installed. This prevents damage to the circuit or equipment the fuse protects. Additionally, fuses and Adapter Screws are color coded to avoid mismatching; for example: 10 Amp Diazed fuses have red pop-out indicators on their head, matching the red ring of the 10 Amp Adapter Screw.

When a Diazed fuse has blown, the color coded indicator on the head of the fuse will pop out, giving visible indication through a glass window in the Screw Cap.

The Fuse is held in place by the Screw Cap, which is screwed into the Fuse Base. Diazed Fuse Bases are available in one and three pole designs. Fuse Bases can be panel mounted or snapped onto a standard 35mm DIN rail.

Operating Classes

gL/gG - Slow Blow

Protect cable, equipment, and conductors from damage due to overloads and short circuits.

Typical Markings: "T", Trage, gL/gG, Vollschutz,



- Fast Blow

Fast Blow fuses are typically used to protect equipment.

Typical Markings: "F", Flink, (the absence of the snail symbol)

gR - Semiconductor Protection

Typically used for protecting semiconductors like diodes, SCRs, etc. Current limiting.

Typical Markings: Ultra Rapid™, Ultra Quick™, Silized™, Recticur™, gR,



Mostly red, orange, or blue imprint.

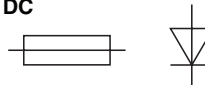

ND-E 16

Ordering Information

Slow Blow - Operating Class gL/gG (VDE 0636 / IEC 269) Cable, Equipment, and Line Protection, up to 500V AC (660V and 750V available)

Fast Blow (CEE-16) - old standard for Equipment Protection, up to 500V AC (750V available)

Semiconductor Protection - Operating Class gR (VDE 0636 / IEC 269) Semiconductor Protection, up to 500V AC, 440V DC

Screw Cap (pgs 10-11)**

Adapter Screw (pgs 10-11) (Install only with Adapter Screw Tool)**

Adapter Screw Tool (pgs 10-11) (for inserting or removing all Adapter Screws)**

Fuse Base, Single Pole (pgs 10-11)
Fuse Base, Three Pole (pgs 10-11)****

Fuse Base Cover, Single Pole (pgs 10-11)
Fuse Base Cover, Three Pole (pgs 10-11)****

| Current/Voltage | Cat. No. | Color Code | Std. Pk. |
|-----------------|-----------|------------|----------|
| 2/500V AC | 2D16SB | Pink | 25 |
| 4/500V AC | 4D16SB | Brown | 25 |
| 6/500V AC | 6D16SB | Green | 25 |
| 10/500V AC | 10D16SB | Red | 25 |
| 16/500V AC | 16D16SB | Gray | 25 |
| 20/500V AC | 20D16SB | Blue | 25 |
| 25/500V AC | 25D16SB | Yellow | 25 |
| 30/500V AC | 30D16SB * | Silver | 25 |
| 35/500V AC | 35D16SB * | Black | 25 |

| | | | |
|------------|-----------|--------|----|
| 2/500V AC | 2D16FB | Pink | 25 |
| 4/500V AC | 4D16FB | Brown | 25 |
| 6/500V AC | 6D16FB | Green | 25 |
| 10/500V AC | 10D16FB | Red | 25 |
| 16/500V AC | 16D16FB | Gray | 25 |
| 20/500V AC | 20D16FB | Blue | 25 |
| 25/500V AC | 25D16FB | Yellow | 25 |
| 30/500V AC | 30D16FB * | Silver | 25 |
| 35/500V AC | 35D16FB * | Black | 25 |

| | | | |
|------------|---------|--------|----|
| 2/500V AC | 2D16SC | Pink | 25 |
| 4/500V AC | 4D16SC | Brown | 25 |
| 6/500V AC | 6D16SC | Green | 25 |
| 10/500V AC | 10D16SC | Red | 25 |
| 16/500V AC | 16D16SC | Gray | 25 |
| 20/500V AC | 20D16SC | Blue | 25 |
| 25/500V AC | 25D16SC | Yellow | 25 |
| 30/500V AC | 30D16SC | Black | 25 |

D16C 1

Not Available

Not Available

D16B 1

D16B3 1

D16BC 1

D16BC3 1

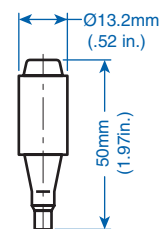

* Not standard rating.

** Refer to page indicated for additional selection and ordering information.

Dimensions to DIN 49360



DII-E 27



DIII-E 33



DIV- R 1.25

| Current/ Voltage | Cat. No. | Color Code | Std. Pk. |
|---------------------|-----------------|---------------|----------|
| 2/500V AC | 2D27SB | Pink | 5 |
| 4/500V AC | 4D27SB | Brown | 5 |
| 6/500V AC | 6D27SB | Green | 5 |
| 10/500V AC | 10D27SB | Red | 5 |
| 16/500V AC | 16D27SB | Gray | 5 |
| 20/500V AC | 20D27SB | Blue | 5 |
| 25/500V AC | 25D27SB | Yellow | 5 |
| 30/500V AC | 30D27SB* | Silver | 5 |
| 35/500V AC | 35D27SB* | Black | 5 |

| | | | |
|------------|-----------------|--------|---|
| 2/500V AC | 2D27FB | Pink | 5 |
| 4/500V AC | 4D27FB | Brown | 5 |
| 6/500V AC | 6D27FB | Green | 5 |
| 10/500V AC | 10D27FB | Red | 5 |
| 16/500V AC | 16D27FB | Grey | 5 |
| 20/500V AC | 20D27FB | Blue | 5 |
| 25/500V AC | 25D27FB | Yellow | 5 |
| 30/500V AC | 30D27FB* | Silver | 5 |
| 35/500V AC | 35D27FB* | Black | 5 |

| | | | |
|------------|----------------|--------|---|
| 2/500V AC | 2D27SC | Pink | 5 |
| 4/500V AC | 4D27SC | Brown | 5 |
| 6/500V AC | 6D27SC | Green | 5 |
| 10/500V AC | 10D27SC | Red | 5 |
| 16/500V AC | 16D27SC | Grey | 5 |
| 20/500V AC | 20D27SC | Blue | 5 |
| 25/500V AC | 25D27SC | Yellow | 5 |
| 30/500V AC | 30D27SC | Black | 5 |

D27C 1

Refer to pgs 10-11

DAT 1

D27B 1
D27B3 1

D27BC 1
D27BC3 1

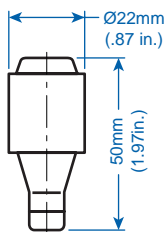

Dimensions to DIN 49515

| Current/ Voltage | Cat. No. | Color Code | Std. Pk. |
|---------------------|------------------|---------------|----------|
| 35/500V AC | 35D33SB | Black | 5 |
| 40/500V AC | 40D33SB* | Black | 5 |
| 50/500V AC | 50D33SB | White | 5 |
| 63/500V AC | 63D33SB | Copper | 5 |
| 80/500V AC | 80D33SB* | Silver | 5 |
| 100/500V AC | 100D33SB* | Silver | 5 |

| | | | |
|-------------|------------------|--------|---|
| 35/500V AC | 35D33FB | Black | 5 |
| 40/500V AC | 40D33FB* | Black | 5 |
| 50/500V AC | 50D33FB | White | 5 |
| 63/500V AC | 63D33FB | Copper | 5 |
| 80/500V AC | 80D33FB* | Silver | 5 |
| 100/500V AC | 100D33FB* | Silver | 5 |

| | | | |
|------------|----------------|--------|---|
| 35/500V AC | 35D33SC | Black | 5 |
| 50/500V AC | 50D33SC | White | 5 |
| 63/500V AC | 63D33SC | Copper | 5 |

D33C 1

Refer to pgs 10-11

DAT 1

D33B 1
D33B3 1

D33BC 1
D33BC3 1

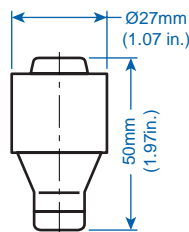

Dimensions to DIN 49515

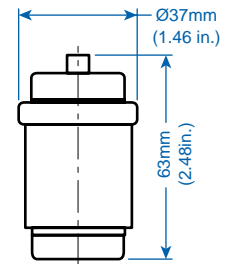

For DIV fuses, please consult Altech.



DV- R 2

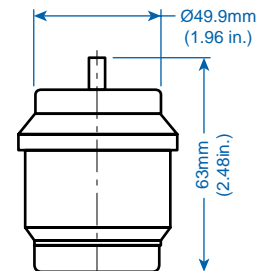

For DV fuses, please consult Altech.

NEOZED

Neozed Fuses are more compact than the Diazed Fuses. Three sizes are available, D01 to 16 Amps, D02 to 63 Amps and D03 to 100 Amps. Fuse accessories are sized to match. Each size fuse body has a different diameter to fit only into the appropriate Screw Cap and Fuse Base. (See illustration pg 10.)

Also, the fuse tips have different diameters, depending on their current rating. The diameter of the tip matches the diameter of the hole in the Adapter Ring to insure that no fuse with a higher rating than intended for the circuit can be installed. This prevents damage to the circuit or equipment the fuse protects. Additionally, fuses and Adapter Rings are color coded to avoid mismatching; for example: 10 Amp Neozed fuses have red pop-out indicators on their head, matching the red 10 Amp Adapter Ring.

When a Neozed fuse has blown, the color coded indicator on the head of the fuse will pop out, giving visible indication through a glass window in the Screw Cap.

The Fuse is held in place by the Screw Cap, which is screwed into the Fuse Base. Neozed Fuse Bases are available in one and three pole designs. Fuse Bases can be panel mounted or snapped onto a standard 35mm DIN rail.

Operating Classes

gL/gG - Slow Blow

Protect cable, conductors, and equipment from damage due to overload and short circuits.

Typical Markings: gL/gG

gR - Semiconductor Protection

Protects semiconductors like diodes, SCRs, etc. Current limiting super fast blow characteristic for short circuit protection.

Typical Markings: Ultra Rapid™, Ultra Quick™, Recticur™, gR,

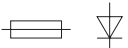

Mostly red, orange, or blue imprint.



D01

| Ordering Information | Current/ Voltage | Cat. No. | Color Code | Std. Pk. |
|---|---------------------|--------------------|---------------|-------------|
| Slow Blow - Operating Class gL/gG (VDE 0636 / IEC 269) Cable, Line, and Equipment Protection up to 380V AC and 250V DC | 2/380V AC | 2NZ01GL | Pink | 10 |
| | 4/380V AC | 4NZ01GL | Brown | 10 |
| | 6/380V AC | 6NZ01GL | Green | 10 |
| | 10/380V AC | 10NZ01GL | Red | 10 |
| | 16/380V AC | 16NZ01GL | Gray | 10 |
| Semiconductor Protection - Operating Class gR (VDE 0636 / IEC 269) Semiconductor Protection up to 440V AC and 250V DC | 2/440V AC | 2NZ01SC | Pink | 5 |
| | 4/440V AC | 4NZ01SC | Brown | 5 |
| | 6/440V AC | 6NZ01SC | Green | 5 |
| | 10/440V AC | 10NZ01SC | Red | 5 |
| | 16/440V AC | 16NZ01SC | Gray | 5 |
| Screw Cap (pgs 10-11)* | | NZ01C | | 1 |
| Adapter Ring (pgs 10-11)* (Install only with Adapter Ring Tool) | | refer to pgs 10-11 | | |
| Adapter Ring Tool (pgs 10-11)* (for inserting or removing all Adapter Rings) | | NAT | | 1 |
| Fuse Base, Single Pole (pgs 10-11)* Fuse Base, Three Pole (pgs 10-11)* | | NZ01B | | 1 |
| | | NZ01B3 | | 1 |
| Fuse Base Cover, Single Pole (pgs 10-11)* Fuse Base Cover, Three Pole (pgs 10-11)* | | NZ01BC | | 1 |
| | | NZ01BC3 | | 1 |

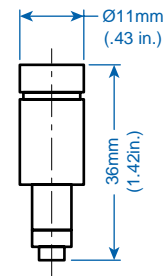
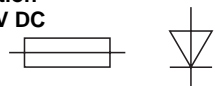

*Refer to page indicated for additional selection and ordering information.

Dimensions to DIN 49522



D02



D03

| Current/ Voltage | Cat. No. | Color Code | Std. Pk. |
|---------------------|-----------------|---------------|-------------|
| 20/380V AC | 20NZ02GL | Blue | 10 |
| 25/380V AC | 25NZ02GL | Yellow | 10 |
| 35/380V AC | 35NZ02GL | Black | 10 |
| 50/380V AC | 50NZ02GL | White | 10 |
| 63/380V AC | 63NZ02GL | Copper | 10 |

| Current/ Voltage | Cat. No. | Color Code | Std. Pk. |
|---------------------|------------------|---------------|-------------|
| 80/380V AC | 80NZ03GL | Silver | 10 |
| 100/380V AC | 100NZ03GL | Red | 10 |

| | | | |
|------------|-----------------|--------|---|
| 20/440V AC | 20NZ02SC | Blue | 5 |
| 25/440V AC | 25NZ02SC | Yellow | 5 |
| 35/440V AC | 35NZ02SC | Black | 5 |
| 50/440V AC | 50NZ02SC | White | 5 |
| 63/440V AC | 63NZ02SC | Copper | 5 |

| | | | |
|-------------|------------------|--------|---|
| 80/440V AC | 80NZ03SC | Silver | 5 |
| 100/440V AC | 100NZ03SC | Red | 5 |

NZ02C 1

refer to pgs 10-11

N AT 1

NZ02B 1
NZ02B3 1

NZ02BC 1
NZ02BC3 1

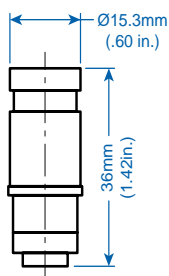

Dimensions to DIN 49522

NZ03C 1

refer to pg 10-11

N AT 1

NZ03B 1

NZ03BC 1

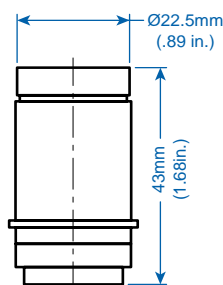

Dimensions to DIN 49522

DIAZED AND NEOZED ACCESSORIES

SCREW CAP

The Screw Cap types offered fit the various fuse and Fuse Base sizes. They hold the fuses in place and connect the head of the fuse with the load side of the Fuse Holder. The colored blown fuse indicator on the head of the fuse is clearly visible through a small window in the top of the Screw Cap. A small test hole on the side of the Cap allows for a probe to test if voltage is present on the metallic surface on the head of the fuse.

ADAPTER SCREW / RING

Adapter Screws are used with the Diazed, and Adapter Rings are used with the Neozed Fuses. Three sizes of Screws and Rings are available to fit the diameter of the different size fuse bases. Adapter Screws are porcelain rings with a center hole on one side, a threaded stud on the other and one notch on each side. The inside diameter of the center hole of the Adapter Screw matches the diameter of the tip of the Diazed fuse for which it is intended. This helps to eliminate the insertion of fuses with higher current ratings than allowed. The integral threaded stud installs into the appropriate Diazed Fuse Base. Adapter Screws and Rings are color coded to the fuses.

FUSE BASE

Fuse Bases hold fuses in place (in conjunction with the Screw Cap) and insure proper electrical connections. They snap easily onto standard 35mm DIN rail or can be panel mounted. They are available in one or three pole designs. Matching Covers are available. The line is connected to the metal tab at the bottom of the fuse base. The load is connected to the metal ring into which the Screw Cap is installed.

FUSE BASE COVER

Fuse Base Covers are available in one and three pole designs to match the Fuse Bases we offer. They help prevent shock from accidental touching of conducting metal parts on the Base.

TOOLS

The Adapter Screw / Ring Tools aid in the insertion and removal of the Adapters from the Fuse Base. The Adapter Screw Tool fits into notches on the Adapter Screw for the D27 and D33 Diazed fuses. The Adapter Ring Tool fits the Adapter Rings for the D01, D02 and D03 Neozed fuses. We strongly recommend these tools be used when inserting or removing Adapter Screws or Rings to prevent electrical shocks.

The Diazed System

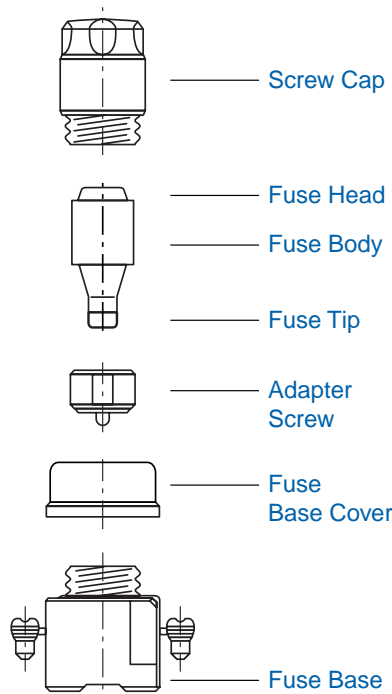

Diazed Screw Cap

| Cat. No. | Height | Approx. Dim. mm (in.) | | Use With Fuse(s) |
|----------|-----------|-----------------------|-------------|------------------|
| | | Height | Thread Dia. | |
| D16C | 34 (1.34) | 16 (.63) | | ND-E 16 |
| D27C | 43 (1.69) | 27 (1.06) | | DII-E 27 |
| D33C | 43 (1.69) | 33 (1.30) | | DIII-E 33 |



Diazed Adapter Screw Tool

| Cat. No. | Use With Fuse (s) |
|----------|---------------------|
| DAT | DII-E 27, DIII-E 33 |

The Neozed System

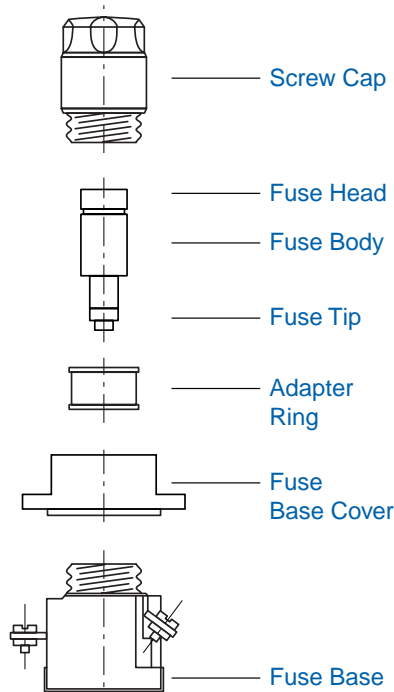

Neozed Screw Cap

| Cat. No. | Height | Approx. Dim. mm (in.) | | Use With Fuse(s) |
|----------|-----------|-----------------------|-------------|------------------|
| | | Height | Thread Dia. | |
| NZ01C | 31 (1.22) | 14 (.55) | | D01 |
| NZ02C | 31 (1.22) | 18 (.71) | | D02 |
| NZ03C | 37 (1.46) | 30 (1.18) | | D03 |



Neozed Adapter Ring Tool

| Cat. No. | Use With Fuse(s) |
|----------|------------------|
| NAT | D01, D02, D03 |



Diazed Adapter Screw

| Cat. No. | Current | Color | Use With Fuse(s) |
|--------------------------------|---------|--------|------------------|
| For Fuse Type DII-E 27 | | | |
| D27AS02 | 2A | Pink | 2D27SB(FB)(SC) |
| D27AS04 | 4A | Brown | 4D27SB(FB)(SC) |
| D27AS06 | 6A | Green | 6D27SB(FB)(SC) |
| D27AS10 | 10A | Red | 10D27SB(FB)(SC) |
| D27AS16 | 16A | Gray | 16D27SB(FB)(SC) |
| D27AS20 | 20A | Blue | 20D27SB(FB)(SC) |
| D27AS25 | 25A | Yellow | 25D27SB(FB)(SC) |
| Height : 14mm (.55 in.) | | | |
| For Fuse Type DIII-E 33 | | | |
| D33AS35 | 35A | Black | 35D33SB(FB)(SC) |
| D33AS40 | 40A | Black | 40D33SB(FB)(SC) |
| D33AS50 | 50A | White | 50D33SB(FB)(SC) |
| D33AS63 | 63A | Copper | 63D33SB(FB)(SC) |
| Height : 14mm (.55 in.) | | | |

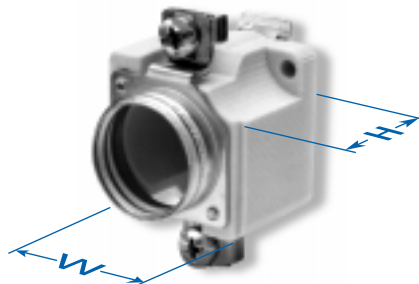

Diazed Fuse Base

| No. of Poles | Cat. No. | Approx. Dim. mm (in.) | | Use With Fuse(s) |
|--------------|----------|-----------------------|------------|------------------|
| | | Height | Width | |
| 1 | D16B | 45 (1.77) | 29 (1.14) | ND-E 16 |
| 1 | D27B | 46 (1.81) | 38 (1.50) | DII-E 27 |
| 1 | D33B | 48 (1.89) | 49 (1.93) | DIII-E 33 |
| 3 | D27B3 | 46 (1.81) | 90 (3.54) | DII-E 27 |
| 3 | D33B3 | 46 (1.81) | 109 (4.29) | DIII-E 33 |

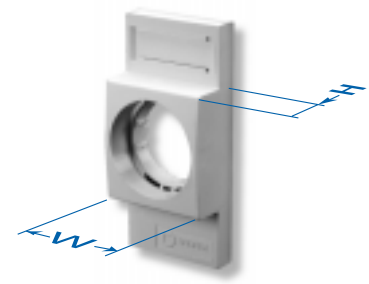

Diazed Fuse Base Cover

| No. of Poles | Cat. No. | Approx. Dim. mm (in.) | | Use With Fuse(s) |
|--------------|----------|-----------------------|------------|------------------|
| | | Height | Width | |
| 1 | D16BC | 20 (.79) | 40 (1.57) | ND-E 16 |
| 1 | D27BC | 20 (.79) | 40 (1.57) | DII-E 27 |
| 1 | D33BC | 20 (.79) | 49 (1.93) | DIII-E 33 |
| 3 | D27BC3 | 20 (.79) | 90 (3.54) | DII-E 27 |
| 3 | D33BC3 | 20 (.79) | 111 (4.37) | DIII-E 33 |



Neozed Adapter Ring

| Cat. No. | Current | Color | Use With Fuse(s) |
|--------------------------|---------|--------|------------------|
| For Fuse Type D01 | | | |
| NZ01AR02 | 2A | Pink | 2NZ01GL(SC) |
| NZ01AR04 | 4A | Brown | 4NZ01GL(SC) |
| NZ01AR06 | 6A | Green | 6NZ01GL(SC) |
| NZ01AR10 | 10A | Red | 10NZ01GL(SC) |
| Height : 10mm (.39 in.) | | | |
| For Fuse Type D02 | | | |
| NZ02AR20 | 20A | Blue | 20NZ02GL(SC) |
| NZ02AR25 | 25A | Yellow | 25NZ02GL(SC) |
| NZ02AR35 | 35A | Black | 35NZ02GL(SC) |
| NZ02AR50 | 50A | White | 50NZ02GL(SC) |
| Height : 10mm (.39 in.) | | | |
| For Fuse Type D03 | | | |
| NZ03AR80 | 80A | Silver | 80NZ03GL(SC) |
| Height : 10mm (.39 in.) | | | |

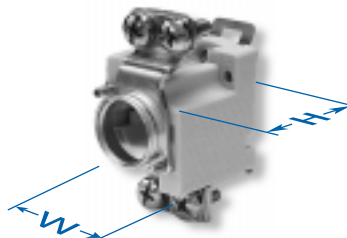

Neozed Fuse Base

| No. of Poles | Cat. No. | Approx. Dim. mm (in.) | | Use With Fuse(s) |
|--------------|----------|-----------------------|-----------|------------------|
| | | Height | Width | |
| 1 | NZ01B | 42 (1.65) | 27 (1.06) | D01 |
| 1 | NZ02B | 42 (1.65) | 27 (1.06) | D02 |
| 1 | NZ03B | 46 (1.81) | 44 (1.73) | D03 |
| 3 | NZ01B3 | 42 (1.65) | 81 (3.19) | D01 |
| 3 | NZ02B3 | 42 (1.65) | 81 (3.19) | D02 |

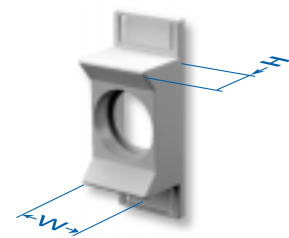

Neozed Fuse Base Cover

| No. of Poles | Cat. No. | Approx. Dim. mm (in.) | | Use With Fuse(s) |
|--------------|----------|-----------------------|-----------|------------------|
| | | Height | Width | |
| 1 | NZ01BC | 23 (.91) | 27 (1.06) | D01 |
| 1 | NZ02BC | 23 (.91) | 27 (1.06) | D02 |
| 1 | NZ03BC | 18 (.71) | 44 (1.73) | D03 |
| 3 | NZ01BC3 | 23 (.91) | 81 (3.19) | D01 |
| 3 | NZ02BC3 | 23 (.91) | 81 (3.19) | D02 |

CYLINDER

Cylinder Fuses are typically used in industrial applications to protect electrical devices such as motors, drives, etc.

They are available in four sizes with a current range from 1 to 100 Amps. Cylinder Fuses have metal caps at both ends, and a porcelain fuse body.

Please refer to pg 15 for ordering information for Cylinder Fuse Holders.

Operating Class

GI / gL / gG - Line Protection

Slow Blow, typically used for power distribution and resistive loads.

Typical Markings: gL, gG

Black imprint.

aM - Motor Protection

Fast acting short circuit protection, but slow acting overload protection.

Typical Marking: aM

Green imprint.

aR - Semiconductor Protection

Typically used for protecting semiconductors like diodes, SCR's etc. Current limiting, super fast blow.

Typical Markings: Ultra Rapid™,

Ultra Quick™, Protister™, gR,

Blue imprint.



8 x 32

| Ordering Information | Current/ Voltage | Cat. No. | Std. Pk. | |
|---|--|------------------|-----------------|----|
| Slow Blow - Operating Class gI (IEC 269 / CEI 32) Line Protection | 1/400V AC | 1C8x32GI | 10 | |
| | 2/400V AC | 2C8x32GI | 10 | |
| | 4/400V AC | 4C8x32GI | 10 | |
| | 6/400V AC | 6C8x32GI | 10 | |
| | 8/400V AC | 8C8x32GI | 10 | |
| | 10/400V AC | 10C8x32GI | 10 | |
| | 12/400V AC | 12C8x32GI | 10 | |
| | 16/400V AC | 16C8x32GI | 10 | |
| | 20/400V AC | 20C8x32GI | 10 | |
| | 25/400V AC | 25C8x32GI | 10 | |
| | Weight: 4 g each | | | |
| | Fast Blow - Operating Class aM (IEC 269 / CEI 32) Motor Protection | 1/400V AC | 1C8x32AM | 10 |
| 2/400V AC | | 2C8x32AM | 10 | |
| 4/400V AC | | 4C8x32AM | 10 | |
| 6/400V AC | | 6C8x32AM | 10 | |
| 8/400V AC | | 8C8x32AM | 10 | |
| 10/400V AC | | 10C8x32AM | 10 | |
| 12/400V AC | | 12C8x32AM | 10 | |
| 16/400V AC | | 16C8x32AM | 10 | |
| 20/400V AC | | 20C8x32AM | 10 | |
| 25/400V AC | | 25C8x32AM | 10 | |
| Weight: 4 g each | | | | |
| Semiconductor Protection - Operating Class gR (VDE 0636 / IEC 269) Semiconductor Protection | | | | |

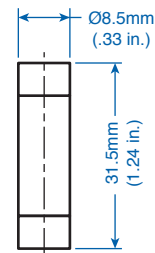
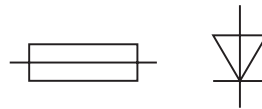

Dimensions to NFC 61200, NFC 63210,
NFC 63211 (NFC = French Standard)

* Selected fuse are also available with Striker Pin. When ordering Fuse with Striker Pin, designate suffix "IS" after the Cat. No. (Ex. 2C14x51GI/IS). Contact Altech for more information.



10 x 38

| Current/ Voltage | Cat. No. | Std. Pk. |
|---------------------|--------------------|----------|
| 0.5/500V AC | 0.5C10x38GI | 10 |
| 1/500V AC | 1C10x38GI | 10 |
| 2/500V AC | 2C10x38GI | 10 |
| 4/500V AC | 4C10x38GI | 10 |
| 6/500V AC | 6C10x38GI | 10 |
| 8/500V AC | 8C10x38GI | 10 |
| 10/500V AC | 10C10x38GI | 10 |
| 12/500V AC | 12C10x38GI | 10 |
| 16/500V AC | 16C10x38GI | 10 |
| 20/400V AC | 20C10x38GI | 10 |
| 25/400V AC | 25C10x38GI | 10 |
| 32/400V AC | 32C10x38GI | 10 |

Weight: 10 g each

| | | |
|-------------|--------------------|----|
| 0.5/500V AC | 0.5C10x38AM | 10 |
| 1/500V AC | 1C10x38AM | 10 |
| 2/500V AC | 2C10x38AM | 10 |
| 4/500V AC | 4C10x38AM | 10 |
| 6/500V AC | 6C10x38AM | 10 |
| 8/500V AC | 8C10x38AM | 10 |
| 10/500V AC | 10C10x38AM | 10 |
| 12/500V AC | 12C10x38AM | 10 |
| 16/500V AC | 16C10x38AM | 10 |
| 20/400V AC | 20C10x38AM | 10 |
| 25/400V AC | 25C10x38AM | 10 |
| 32/400V AC | 32C10x38AM | 10 |

Weight: 10 g each

| | | |
|------------|-------------------------------|----|
| 1/600V AC | DISCONTINUED 1C10x38SC | 10 |
| 2/600V AC | 2C10x38SC | 10 |
| 4/600V AC | 4C10x38SC | 10 |
| 6/600V AC | 6C10x38SC | 10 |
| 8/600V AC | 8C10x38SC | 10 |
| 10/600V AC | 10C10x38SC | 10 |
| 12/600V AC | 12C10x38SC | 10 |
| 16/600V AC | 16C10x38SC | 10 |
| 20/600V AC | 20C10x38SC | 10 |
| 25/600V AC | 25C10x38SC | 10 |
| 30/600V AC | 30C10x38SC | 10 |
| 32/600V AC | 32C10x38SC | 10 |

Weight: 10 g each

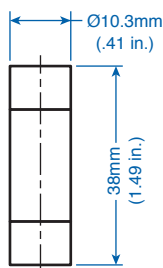

Dimensions to NFC 60200, NFC 63210, NFC 63211 (NFC = French Standard)



14 x 51

| Current/ Voltage | Cat. No. | Std. Pk. |
|---------------------|-------------------------------|----------|
| 1/660V AC | DISCONTINUED 1C14x51GI | 10 |
| 2/690V AC | 2C14x51GI * | 10 |
| 4/690V AC | 4C14x51GI * | 10 |
| 6/690V AC | 6C14x51GI * | 10 |
| 8/690V AC | 8C14x51GI * | 10 |
| 10/690V AC | 10C14x51GI * | 10 |
| 12/690V AC | 12C14x51GI * | 10 |
| 16/690V AC | 16C14x51GI * | 10 |
| 20/690V AC | 20C14x51GI * | 10 |
| 25/690V AC | 25C14x51GI * | 10 |
| 32/500V AC | 32C14x51GI | 10 |
| 40/500V AC | 40C14x51GI | 10 |
| 50/500V AC | 50C14x51GI | 10 |

Weight: 20 g each

| | | |
|------------|-------------------------------|----|
| 1/660V AC | DISCONTINUED 1C14x51AM | 10 |
| 2/690V AC | 2C14x51AM * | 10 |
| 4/690V AC | 4C14x51AM * | 10 |
| 6/690V AC | 6C14x51AM * | 10 |
| 8/690V AC | 8C14x51AM * | 10 |
| 10/690V AC | 10C14x51AM * | 10 |
| 12/690V AC | 12C14x51AM * | 10 |
| 16/690V AC | 16C14x51AM * | 10 |
| 20/690V AC | 20C14x51AM * | 10 |
| 25/690V AC | 25C14x51AM * | 10 |
| 32/500V AC | 32C14x51AM | 10 |
| 40/500V AC | 40C14x51AM | 10 |
| 50/500V AC | 50C14x51AM | 10 |

Weight: 20 g each

| | | |
|------------|-------------------------------|----|
| 1/660V AC | DISCONTINUED 1C14x51SC | 10 |
| 2/660V AC | 2C14x51SC | 10 |
| 4/660V AC | 4C14x51SC | 10 |
| 6/660V AC | 6C14x51SC | 10 |
| 8/660V AC | 8C14x51SC | 10 |
| 10/690V AC | 10C14x51SC * | 10 |
| 12/690V AC | 12C14x51SC * | 10 |
| 16/690V AC | 16C14x51SC * | 10 |
| 20/690V AC | 20C14x51SC * | 10 |
| 25/690V AC | 25C14x51SC * | 10 |
| 32/690V AC | 32C14x51SC * | 10 |
| 40/690V AC | 40C14x51SC * | 10 |
| 50/690V AC | 50C14x51SC * | 10 |

Weight: 20 g each

*Also available with striker pin.

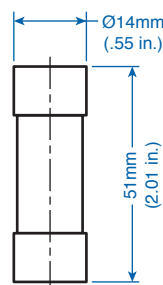

Dimensions to NFC 60200, NFC 63210, NFC 63211 (NFC = French Standard)



22 x 58

| Current/ Voltage | Cat. No. | Std. Pk. |
|---------------------|---------------------------------|----------|
| 6/660V AC | DISCONTINUED 6C22x58GI * | 10 |
| 8/660V AC | 8C22x58GI * | 10 |
| 10/660V AC | 10C22x58GI * | 10 |
| 12/660V AC | 12C22x58GI * | 10 |
| 16/690V AC | 16C22x58GI * | 10 |
| 20/690V AC | 20C22x58GI * | 10 |
| 25/690V AC | 25C22x58GI * | 10 |
| 32/690V AC | 32C22x58GI * | 10 |
| 40/690V AC | 40C22x58GI * | 10 |
| 50/500V AC | 50C22x58GI * | 10 |
| 63/500V AC | 63C22x58GI * | 10 |
| 80/500V AC | 80C22x58GI * | 10 |
| 100/500V AC | 100C22x58GI * | 10 |

Weight: 51 g each

| | | |
|-------------|---------------------------------|----|
| 6/660V AC | DISCONTINUED 6C22x58AM * | 10 |
| 8/660V AC | 8C22x58AM * | 10 |
| 10/660V AC | 10C22x58AM * | 10 |
| 12/660V AC | 12C22x58AM * | 10 |
| 16/690V AC | 16C22x58AM * | 10 |
| 20/690V AC | 20C22x58AM * | 10 |
| 25/690V AC | 25C22x58AM * | 10 |
| 32/690V AC | 32C22x58AM * | 10 |
| 40/690V AC | 40C22x58AM * | 10 |
| 50/690V AC | 50C22x58AM * | 10 |
| 63/500V AC | 63C22x58AM * | 10 |
| 80/500V AC | 80C22x58AM * | 10 |
| 100/500V AC | 100C22x58AM * | 10 |

Weight: 51 g each

| | | |
|-------------|-------------------------------|----|
| 4/660V AC | DISCONTINUED 4C22x58SC | 10 |
| 6/660V AC | 6C22x58SC | 10 |
| 8/660V AC | 8C22x58SC | 10 |
| 10/660V AC | 10C22x58SC | 10 |
| 12/660V AC | 12C22x58SC | 10 |
| 16/660V AC | 16C22x58SC | 10 |
| 20/690V AC | 20C22x58SC * | 10 |
| 25/690V AC | 25C22x58SC * | 10 |
| 32/690V AC | 32C22x58SC * | 10 |
| 40/690V AC | 40C22x58SC * | 10 |
| 50/690V AC | 50C22x58SC * | 10 |
| 63/690V AC | 63C22x58SC * | 10 |
| 80/690V AC | 80C22x58SC * | 10 |
| 100/500V AC | 100C22x58SC * | 10 |

Weight: 51 g each

*Also available with striker pin.

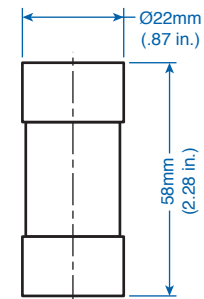

Dimensions to NFC 60200, NFC 63210, NFC 63211 (NFC = French Standard)

Fuse Holders, 10 x 38 mm and CC Type

The main characteristics of fuse disconnectors are:

- UL recognized (10x38mm)
- UL listed (CC Type)
- Compliance with IEC 60947-1, IEC 60947-3
- Plastic parts are made of material resistant to high temperatures
- All contact surfaces are silver plated
- Mounting on standard DIN 35 mm rail (DIN EN60715).
- Available up to 4 pole
- For all sizes a version with electronic indicator is available. There are two technical types of indicator:

L (LED) (10x38mm only) with built in LED diode which blinks after the fuse-link operates. The internal circuit resistance is 2M, thus the total dissipation is minimal. The indicator is capable of operating in conditions of open circuit with minimum capacitance between connection cables. Operating voltage range spans from 50V to 690V AC and DC.

I (NEON) (10x38mm only) with neon lamp, which is constantly lit after the fuse-link operates. The internal circuit resistance is 570k, thus it is necessary that the circuit be closed in order for the indicator to function. The operational voltage range is 100 V to 750 V AC.

* Fuses are sold separately Altech, see pages 100-101.

** 1000V UL PV rating pending.



CC Type

| | 1 POLE | 2 POLE | 3 POLE |
|--|--------|--------|--------|
|--|--------|--------|--------|



| | | | |
|---------------------|------------------------|------------------------|------------------------|
| Terminal Width (B) | 17.5 mm | 35 mm | 52.5 mm |
| Height x Length | 81 x 64.5 mm | 81 x 64.5 mm | 81 x 64.5 mm |
| Stripping Length | 11 mm | 11 mm | 11 mm |
| Insulation Material | Aculon® | Aculon® | Aculon® |
| Type of Connection | 2 screw clamps | 2 screw clamps | 2 screw clamps |
| Wire Range | 1.5-25sq.mm / 24-4 AWG | 1.5-25sq.mm / 24-4 AWG | 1.5-25sq.mm / 24-4 AWG |
| IEC Rating | 690 V / 32A | 690 V / 32A | 690 V / 32A |
| UL/CSA Rating | 600 V AC/DC / 30A | 600 V AC/DC / 30A | 600 V AC/DC / 30A |
| Torque | 2-2.5 Nm / 31 lb-in | 2-2.5 Nm / 31 lb-in | 2-2.5 Nm / 31 lb-in |

Cylindrical 10x38

| Indicator: | Cat. No. | Std. Pk. | Cat. No. | Std. Pk. | Cat. No. | Std. Pk. |
|------------|------------|----------|------------|----------|------------|----------|
| None | CB1038-1 | 1 | CB1038-2 | 1 | CB1038-3 | 1 |
| LED | CB1038-1/L | 1 | CB1038-2/L | 1 | CB1038-3/L | 1 |
| Neon | CB1038-1/I | 1 | CB1038-2/I | 1 | CB1038-3/I | 1 |

| Type of Fuse Used | Ø10 x 38 mm | Ø10 x 38 mm | Ø10 x 38 mm |
|-------------------|--------------------|--------------------|--------------------|
| Approvals** | IEC, UL US E212627 | IEC, UL US E212627 | IEC, UL US E212627 |

CC Type Holder

| Cat. No. | Std. Pk. | Cat. No. | Std. Pk. | Cat. No. | Std. Pk. |
|----------|----------|----------|----------|----------|----------|
| CB10CC-1 | 1 | CB10CC-2 | 1 | CB10CC-3 | 1 |

| Type of Fuse Used | CC Type | CC Type | CC Type |
|-------------------|--------------------|--------------------|--------------------|
| Approvals | IEC, UL US E212627 | IEC, UL US E212627 | IEC, UL US E212627 |

| DIN Rail | 35mm | 35mm | 35mm | 35mm |
|---|------|------|------|------|
| for ordering information refer to pages 90-91 | | | | |

| | | | | | | |
|---|-------|----|-------|----|-------|----|
| End Stop | CA702 | 50 | CA702 | 50 | CA702 | 50 |
| for ordering information refer to page 92 | CA802 | 50 | CA802 | 50 | CA802 | 50 |

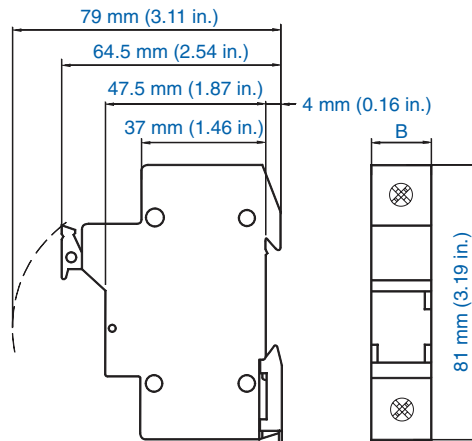

Dimension for B:

| | |
|------------------|--------|
| 1 Pole | 17.5mm |
| 1 Pole + Neutral | 35mm |
| 2 Pole | 35mm |
| 3 Pole | 52.5mm |
| 3 Pole + Neutral | 70mm |

Cylinder Fuse Holders, 8 x 31 mm, 14 x 51 mm and 22 x 58 mm

Fuse Bases secure the fuses in place and insure proper electrical connections. Fuse Bases are available in one, two, three and four pole designs. Types 8x31 and 10x38 are easily DIN rail mounted; Types 14x51 and 22x58 can be DIN rail mounted or mounted to any flat surface. Cylinder Fuse Bases are available with optional blown fuse indication.

The main characteristics of fuse disconnectors are:











- UL recognized (8x31 and 14x51 mm only)
- Compliance with IEC 60947-1, IEC 60947-3
- Plastic parts are made of material resistant to high temperatures
- All contact surfaces are silver plated
- Mounting on standard DIN 35 mm rail (DIN EN60715).
- Available up to 4 pole
- For all sizes a version with electronic indicator is available.

The 8x31 fuse holders with indicator are built with a NEON lamp, which is constantly lit after the fuselink operates. The internal circuit resistance is 570k, thus it is necessary that the circuit be closed in order for the indicator to function. The operational voltage range is 100 V to 750 V AC.

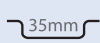
The 14x51 and 22x58 fuse holders with indicator have a built in LED which blinks after the fuse-link operates. The internal circuit resistance is 2M, thus the total dissipation is minimal. The indicator is capable of operating in conditions of open circuit with minimum capacitance between connection cables. Operating voltage range spans from 50V to 690V AC and DC.

| | 8 x 31 | 14 x 51 | 22 x 58 |
|----------------------------|----------------------------------|--|--|
| Terminal Width | | | |
| 1 pole: | 17.5 mm (0.69 in.) | 27 mm (1.07 in.) | 27 mm (1.07 in.) |
| 1 pole + indicator: | 17.5 mm (0.69 in.) | 27 mm (1.07 in.) | 27 mm (1.07 in.) |
| 1 pole + N: | 35 mm (1.38 in.) | 54 mm (2.15 in.) | 71 mm (2.80 in.) |
| 2 pole: | 35 mm (1.38 in.) | 54 mm (2.15 in.) | 71 mm (2.80 in.) |
| 2 pole + indicator: | 35 mm (1.38 in.) | 54 mm (2.15 in.) | 71 mm (2.80 in.) |
| 3 pole: | 52.5 mm (2.07 in.) | 81 mm (3.20 in.) | 107 mm (4.20 in.) |
| 3 pole + indicator: | 52.5 mm (2.07 in.) | 81 mm (3.20 in.) | 107 mm (4.20 in.) |
| 3 pole + N: | 70 mm (2.76 in.) | 108 mm (4.25 in.) | 142.5 mm (5.60 in.) |
| Height x Length | 81 x 64.5 mm (3.20 x 2.40 in) | 94 x 70 mm (3.70 x 2.76 in) | 120.5 x 70 mm (4.73 x 2.76 in) |
| Insulation Material | Aculon® | Aculon® | Aculon® |
| Type of Connection | 2 screw clamps | 2 screw clamps | 2 screw clamps |
| Wire Range | | | |
| Minimum | 1 sq mm (18 AWG) | 1 sq mm (18 AWG) | 1.5 sq mm (16 AWG) |
| Max. Stranded | 16 sq mm (6 AWG) | 25 sq mm (4 AWG) | 35 sq mm (2 AWG) |
| Max. Solid | 25 sq mm (4 AWG) | 35 sq mm (2 AWG) | 50 sq mm (1 AWG) |
| UL Rating | 600V AC/DC / 30A | 600V AC/DC / 50A | N/A |
| IEC Rating | 400V AC/DC / 20A | 400V AC/DC / 50A 500V AC/DC / 32A 690V AC/DC / 25A | 400V AC/DC / 125A 500V AC/DC / 100A 690V AC/DC / 80A |
| Torque | 2-2.5 Nm / 31 lb-in | 2.5 Nm / 22 lb-in | 3 Nm / 26 lb-in |

| Type | Cat. No. | Std. Pk. | Cat. No. | Std. Pk. | Cat. No. | Std. Pk. |
|---------------------|------------------|----------|-------------------|----------|-------------------|----------|
| 1 pole: | CB831-1 | 12 | CB1451-1 | 12 | CB2258-1 | 3 |
| 1 pole + indicator: | CB831-1/I | 12 | CB1451-1/I | 12 | CB2258-1/I | 3 |
| 1 pole + N: | CB831-1N | 6 | CB1451-1N | 6 | CB2258-1N | 2 |
| 2 pole: | CB831-2 | 6 | CB1451-2 | 6 | CB2258-2 | 2 |
| 2 pole + indicator: | CB831-2/I | 6 | CB1451-2/I | 6 | CB2258-2/I | 2 |
| 3 pole: | CB831-3 | 4 | CB1451-3 | 4 | CB2258-3 | 1 |
| 3 pole + indicator: | CB831-3/I | 4 | CB1451-3/I | 4 | CB2258-3/I | 1 |
| 3 pole + N: | CB831-3N | 3 | CB1451-3N | 3 | CB2258-3N | 1 |

| Type of Fuse Used | 8x32 mm | | 14x51 mm | | 22x58 mm | |
|--------------------|---|---|--|---|---|---|
| Approvals** |  |  |  |  |  | |
| DIN Rail |  |  |  |  |  |  |
| End Stop | CA702 CA802 | 50 50 | CA702 CA802 | 50 50 | CA702 CA802 | 50 50 |

* Fuses are sold separately.

NH KNIFE BLADE

NH fuses are typically used for power distribution applications and to protect large electrical devices such as motors, drives, etc. They are available in seven sizes with a current range of 2 to 1600 Amps.

NH fuses have knife blades at both ends, which mount into Fuse Bases. Fuse Bases are available in one or three pole designs and can be panel or DIN rail mounted.

Please refer to pg 19 for NH Fuse Accessories.

Operating Classes

gL/gG - Line Protection

Slow, typically used for distribution circuits or resistive loads.

Typical Marking: *gL/gG*



aM - Motor Protection

Fast acting short circuit protection, but slow acting overload protection.

Typical Marking: *aM*
Green imprint.

aR - Semiconductor Protection

Partial range, short circuit protection for devices such as diodes, SCRs, etc.

Typical Markings: *Ultra Rapid™, Sitor™, Silcu™, Protistor™, Recticur™, Ultra Quick™, aR,*

gR - Semiconductor Protection

Full range overload and short circuit protection for devices such as diodes, SCRs, etc.

Typical Markings: *Ultra Rapid™, Sitor™, Silcu™, Protistor™, Recticur™, Ultra Quick™, gR,*
Mostly red, orange or blue imprint.



NH00 (NHC00)³

Ordering Information

Operating Class gL / gG
(VDE 0636 / IEC 269)
Line Protection up to 500V AC
(660V available)

| Current/Voltage | Cat. No. | Dim. | Std. Pk. |
|-----------------|-----------|------|----------|
| 2/500V AC | 2NH00GL | A | 3 |
| 4/500V AC | 4NH00GL | A | 3 |
| 6/500V AC | 6NH00GL | A | 3 |
| 10/500V AC | 10NH00GL | A | 3 |
| 16/500V AC | 16NH00GL | A | 3 |
| 20/500V AC | 20NH00GL | A | 3 |
| 25/500V AC | 25NH00GL | A | 3 |
| 32/500V AC | 32NH00GL | A | 3 |
| 35/500V AC | 35NH00GL | A | 3 |
| 40/500V AC | 40NH00GL | A | 3 |
| 50/500V AC | 50NH00GL | A | 3 |
| 63/500V AC | 63NH00GL | A | 3 |
| 80/500V AC | 80NH00GL | A | 3 |
| 100/500V AC | 100NH00GL | A | 3 |
| 125/500V AC | 125NH00GL | A | 3 |
| 160/500V AC | 160NH00GL | A | 3 |

NH00 Fuses Operating Class gL / gG are available in 660V, and with insulated tags.

Operating Class aM
(VDE 0636 / IEC 269)
Motor Protection up to 660V AC

| | | | |
|-------------|-------------|---|---|
| 2/660V AC | 2NH00AM-6 | A | 3 |
| 4/660V AC | 4NH00AM-6 | A | 3 |
| 6/660V AC | 6NH00AM-6 | A | 3 |
| 10/660V AC | 10NH00AM-6 | A | 3 |
| 16/660V AC | 16NH00AM-6 | A | 3 |
| 20/660V AC | 20NH00AM-6 | A | 3 |
| 25/660V AC | 25NH00AM-6 | A | 3 |
| 32/660V AC | 32NH00AM-6 | A | 3 |
| 35/660V AC | 35NH00AM-6 | A | 3 |
| 40/660V AC | 40NH00AM-6 | A | 3 |
| 50/660V AC | 50NH00AM-6 | A | 3 |
| 63/660V AC | 63NH00AM-6 | A | 3 |
| 80/660V AC | 80NH00AM-6 | A | 3 |
| 100/660V AC | 100NH00AM-6 | A | 3 |
| 125/500V AC | 125NH00AM | A | 3 |
| 160/500V AC | 160NH00AM | A | 3 |

Super Fast Blow Operating Class aR / gR
(VDE 0636 / IEC 269)
Semiconductor Protection up to 660V AC
(1000V available)

| | | | |
|-------------|--------------------------|---|---|
| 16/660V AC | 16NH00GR-6 ¹ | A | 3 |
| 20/660V AC | 20NH00GR-6 ¹ | A | 3 |
| 25/660V AC | 25NH00GR-6 ¹ | A | 3 |
| 32/660V AC | 32NH00GR-6 ¹ | A | 3 |
| 35/660V AC | 35NH00GR-6 ¹ | A | 3 |
| 40/660V AC | 40NH00GR-6 ¹ | A | 3 |
| 50/660V AC | 50NH00GR-6 ¹ | A | 3 |
| 63/660V AC | 63NH00GR-6 ¹ | A | 3 |
| 80/660V AC | 80NH00GR-6 ¹ | A | 3 |
| 100/660V AC | 100NH00GR-6 ¹ | A | 3 |
| 125/660V AC | 125NH00GR-6 ¹ | A | 3 |
| 160/660V AC | 160NH00AR-6 | A | 3 |

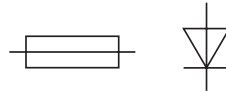

¹ Also available in Operating Class aR.

² Also available in 1000V. Designate suffix "-1" (ex. 32NH0GR-1).

³ Size NHC00 will be supplied in place of NH00 at manufacturer discretion.

⁴ Knife blade is available with screw holes, please designate a "B" after the size, (ex. 250NH3BAR-6).

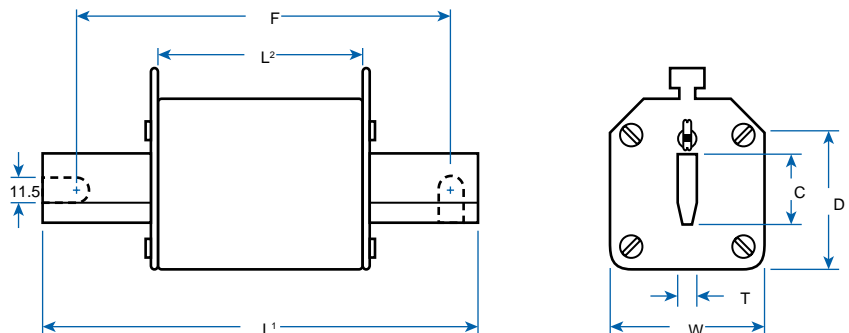



NHO



NH1



NH2

| Current/ Voltage | Cat. No. | Dim. | Std. Pk. | Current/ Voltage | Cat. No. | Dim. | Std. Pk. | Current/ Voltage | Cat. No. | Dim. | Std. Pk. |
|--------------------------|------------|------|----------|--------------------------|-------------------------|------|----------|---------------------|-------------------------|------|----------|
| 10/500V AC | 10NH0GL | B | 3 | 16/500V AC | 16NH1GL | C | 3 | 35/500V AC | 35NH2GL | E | 3 |
| 16/500V AC | 16NH0GL | B | 3 | 20/500V AC | 20NH1GL | C | 3 | 40/500V AC | 40NH2GL | E | 3 |
| 20/500V AC | 20NH0GL | B | 3 | 25/500V AC | 25NH1GL | C | 3 | 50/500V AC | 50NH2GL | E | 3 |
| 25/500V AC | 25NH0GL | B | 3 | 32/500V AC | 32NH1GL | C | 3 | 63/500V AC | 63NH2GL | E | 3 |
| 32/500V AC | 32NH0GL | B | 3 | 35/500V AC | 35NH1GL | C | 3 | 80/500V AC | 80NH2GL | E | 3 |
| 35/500V AC | 35NH0GL | B | 3 | 40/500V AC | 40NH1GL | C | 3 | 100/500V AC | 100NH2GL | E | 3 |
| 40/500V AC | 40NH0GL | B | 3 | 50/500V AC | 50NH1GL | C | 3 | 125/500V AC | 125NH2GL | E | 3 |
| 50/500V AC | 50NH0GL | B | 3 | 63/500V AC | 63NH1GL | C | 3 | 160/500V AC | 160NH2GL | E | 3 |
| 63/500V AC | 63NH0GL | B | 3 | 80/500V AC | 80NH1GL | C | 3 | 200/500V AC | 200NH2GL | E | 3 |
| 80/500V AC | 80NH0GL | B | 3 | 100/500V AC | 100NH1GL | C | 3 | 224/500V AC | 224NH2GL | E | 3 |
| 100/500V AC | 100NH0GL | B | 3 | 125/500V AC | 125NH1GL | C | 3 | 250/500V AC | 250NH2GL | E | 3 |
| 125/500V AC | 125NH0GL | B | 3 | 160/500V AC | 160NH1GL | C | 3 | 300/500V AC | 300NH2GL | E | 3 |
| 160/500V AC | 160NH0GL | B | 3 | 200/500V AC | 200NH1GL | D | 3 | 315/500V AC | 315NH2GL | F | 3 |
| 200/500V AC | 200NH0GL | B | 3 | 224/500V AC | 224NH1GL | D | 3 | 355/500V AC | 355NH2GL | F | 3 |
| | | | | 250/500V AC | 250NH1GL | D | 3 | 400/500V AC | 400NH2GL | F | 3 |
| | | | | | | | | 425/500V AC | 425NH2GL | F | 3 |
| 10/500V AC | 10NH0AM | B | 3 | 16/500V AC | 16NH1AM | C | 3 | 35/500V AC | 35NH2AM | E | 3 |
| 16/500V AC | 16NH0AM | B | 3 | 20/500V AC | 20NH1AM | C | 3 | 40/500V AC | 40NH2AM | E | 3 |
| 20/500V AC | 20NH0AM | B | 3 | 25/500V AC | 25NH1AM | C | 3 | 50/500V AC | 50NH2AM | E | 3 |
| 25/500V AC | 25NH0AM | B | 3 | 32/500V AC | 32NH1AM | C | 3 | 63/500V AC | 63NH2AM | E | 3 |
| 32/500V AC | 32NH0AM | B | 3 | 35/500V AC | 35NH1AM | C | 3 | 80/500V AC | 80NH2AM | E | 3 |
| 35/500V AC | 35NH0AM | B | 3 | 40/500V AC | 40NH1AM | C | 3 | 100/500V AC | 100NH2AM | E | 3 |
| 40/500V AC | 40NH0AM | B | 3 | 50/500V AC | 50NH1AM | C | 3 | 125/500V AC | 125NH2AM | E | 3 |
| 50/500V AC | 50NH0AM | B | 3 | 63/500V AC | 63NH1AM | C | 3 | 160/500V AC | 160NH2AM | E | 3 |
| 63/500V AC | 63NH0AM | B | 3 | 80/500V AC | 80NH1AM | C | 3 | 200/500V AC | 200NH2AM | E | 3 |
| 80/500V AC | 80NH0AM | B | 3 | 100/500V AC | 100NH1AM | C | 3 | 224/500V AC | 224NH2AM | E | 3 |
| 100/500V AC | 100NH0AM | B | 3 | 125/500V AC | 125NH1AM | C | 3 | 250/500V AC | 250NH2AM | E | 3 |
| 125/500V AC | 125NH0AM | B | 3 | 160/500V AC | 160NH1AM | C | 3 | 315/500V AC | 315NH2AM | F | 3 |
| 160/500V AC | 160NH0AM | B | 3 | 200/500V AC | 200NH1AM | D | 3 | 355/500V AC | 355NH2AM | F | 3 |
| | | | | 224/500V AC | 224NH1AM | D | 3 | 400/500V AC | 400NH2AM | F | 3 |
| | | | | 250/500V AC | 250NH1AM | D | 3 | | | | |
| 16/660V AC | 16NH0GR-6 | B | 3 | 16/660V AC | 16NH1GR-6 | C | 3 | 32/660V AC | 32NH2GR-6 | E | 3 |
| 20/660V AC | 20NH0GR-6 | B | 3 | 20/660V AC | 20NH1GR-6 | C | 3 | 40/660V AC | 40NH2GR-6 | E | 3 |
| 25/660V AC | 25NH0GR-6 | B | 3 | 25/660V AC ² | 25NH1GR-6 ⁴ | C | 3 | 50/660V AC | 50NH2GR-6 | E | 3 |
| 32/660V AC ² | 32NH0GR-6 | B | 3 | 32/660V AC ² | 32NH1GR-6 ⁴ | C | 3 | 63/660V AC | 63NH2GR-6 | E | 3 |
| 40/660V AC ² | 40NH0GR-6 | B | 3 | 35/660V AC ² | 35NH1GR-6 ⁴ | C | 3 | 80/660V AC | 80NH2GR-6 ⁴ | E | 3 |
| 50/660V AC ² | 50NH0GR-6 | B | 3 | 40/660V AC ² | 40NH1GR-6 ⁴ | C | 3 | 100/660V AC | 100NH2GR-6 ⁴ | E | 3 |
| 63/660V AC ² | 63NH0GR-6 | B | 3 | 50/660V AC ² | 50NH1GR-6 ⁴ | C | 3 | 125/660V AC | 125NH2GR-6 ⁴ | E | 3 |
| 80/660V AC ² | 80NH0GR-6 | B | 3 | 63/660V AC ² | 63NH1GR-6 ⁴ | C | 3 | 160/660V AC | 160NH2AR-6 ⁴ | E | 3 |
| 100/660V AC ² | 100NH0GR-6 | B | 3 | 80/660V AC ² | 80NH1GR-6 ⁴ | C | 3 | 200/660V AC | 200NH2AR-6 ⁴ | E | 3 |
| 125/660V AC ² | 125NH0GR-6 | B | 3 | 100/660V AC ² | 100NH1GR-6 ⁴ | C | 3 | 250/660V AC | 250NH2AR-6 ⁴ | E | 3 |
| 160/660V AC ² | 160NH0AR-6 | B | 3 | 125/660V AC ² | 125NH1GR-6 ⁴ | C | 3 | 280/660V AC | 280NH2AR-6 ⁴ | E | 3 |
| | | | | 160/660V AC ² | 160NH1AR-6 ⁴ | C | 3 | 315/660V AC | 315NH2AR-6 ⁴ | F | 3 |
| | | | | 200/660V AC ² | 200NH1AR-6 ⁴ | D | 3 | 355/660V AC | 355NH2AR-6 ⁴ | E | 3 |
| | | | | 224/660V AC ² | 224NH1AR-6 ⁴ | D | 3 | 400/660V AC | 400NH2AR-6 ⁴ | F | 3 |
| | | | | 250/660V AC ² | 250NH1AR-6 ⁴ | D | 3 | | | | |
| | | | | 315/500V AC | 315NH1AR | D | 3 | | | | |

Approximate Dimensions for NH Fuses mm (in.)*

| NH Size/Dim. | Overall Length (L ₁) | Body Length (L ₂) | Body Depth (D) | Body Width (W) | Blade Width (T) | Blade Thickness (C) | Fixing Center (F) |
|-----------------|-------------------------------------|----------------------------------|-------------------|-------------------|--------------------|------------------------|----------------------|
| C00 | 79(3.11) | 53 (2.09) | 40 (1.57) | 21 (0.83) | 6 (0.24) | 15 (0.59) | 110 (4.33) |
| 00/A | 79(3.11) | 52 (2.05) | 42.5 (1.67) | 28 (1.10) | 6 (0.24) | 15 (0.59) | 110 (4.33) |
| 0/B | 125 (4.92) | 65 (2.56) | 42 (1.65) | 29 (1.14) | 6 (0.24) | 15 (0.59) | 110 (4.33) |
| 1/C | 135 (5.31) | 65 (2.56) | 42 (1.65) | 29 (1.14) | 6 (0.24) | 15 (0.59) | 110 (4.33) |
| 1/D | 135 (5.31) | 65 (2.56) | 48 (1.89) | 40 (1.57) | 6 (0.24) | 20 (0.79) | 110 (4.33) |
| 2/E | 150 (5.91) | 65 (2.56) | 48 (1.89) | 40 (1.57) | 6 (0.24) | 20 (0.79) | 110 (4.33) |
| 2/F | 150 (5.91) | 65 (2.56) | 60 (2.36) | 53 (2.10) | 6 (0.24) | 26 (1.02) | 110 (4.33) |

*Dimensions to DIN 43620 refer to diagram on pg 16

NH FUSE ACCESSORIES

FUSE BASE

Fuse Bases hold fuses in place and insure proper electrical connections. Available in one or three pole designs. Three-pole Fuse Bases are supplied with two Separator Plates which should be installed between poles. We recommend the use of End Plates and Terminal Covers for increased safety.

END PLATE

End Plates increase safety and provide separation between devices. Install by inserting End Plate into mounting entry slot on right or left side of Fuse Base. We recommend installing one End Plate on each side of the Fuse Base.

TERMINAL COVER

Covers increase safety by covering the conducting metal hardware of the Fuse Base and the Fuse. We suggest Terminal Covers be used in conjunction with End Plates. To install slide Terminal Cover over terminal slot and snap in place.

MICROSWITCH

Microswitches can be field mounted on NH fuses for remote blown fuse indication. (Sketch below)

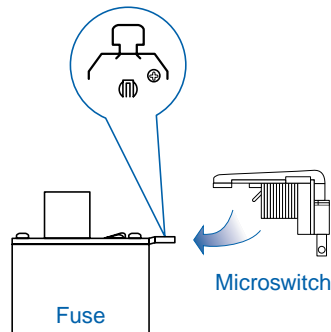

FUSE HANDLE

We strongly suggest using the Fuse Handle when inserting or removing fuses from the Fuse Base to prevent electrical shocks. For increased safety, use Fuse Handle with integral safety glove. Both Fuse Handles are for use with NH-Knife Blade Fuses, NH00 - NH4.



Fuse Base

| No. of Poles | Cat. No. | Length mm (in.) | Use With Fuse(s) |
|--------------|----------------|-----------------|------------------|
| 1 | NHB00-1 | 122 (4.80) | NH00 |
| 3 | NHB00-3 | 139 (5.47) | NH00 |
| 1 | NHB0-1 | 170 (6.69) | NH0 |
| 1 | NHB1-1 | 202 (7.95) | NH1 |
| 3 | NHB1-3 | 214 (8.42) | NH1 |
| 1 | NHB2-1 | 227 (8.94) | NH2 |
| 3 | NHB2-3 | 260 (10.24) | NH2 |
| 1 | NHB3-1 | 242 (9.53) | NH3 |
| 1 | NHB4-1 | 310 (12.20) | NH4 |
| 1 | NHB4A-1 | 338 (13.31) | NH4A |
| 1 | NHSMB | 146 (5.75) | NH00SM |



Fuse End Plate

| Cat. No. | Approx. Dim. mm (in.) | Use With Fuse Base(s) |
|---------------|-----------------------|-----------------------|
| | Width Length | |
| NHEP00 | 62 (2.44) 121 (4.76) | NHB00-1-3 |
| NHEP0 | 62 (2.44) 180 (7.09) | NHB0-1-3 |
| NHEP1 | 62 (2.44) 214 (8.42) | NHB1-1-3 |
| NHEP2 | 90 (3.54) 260 (10.24) | NHB2-1-3 |
| NHEP3 | 101 (3.98) 242 (9.53) | NHB3-1-3 |



Microswitch

| Cat. No. | Current/Voltage | Use With Fuse(s) |
|-------------|------------------|---|
| NHMS | 5/250V AC (SPDT) | NH Knife Blade or NH Stud Mount (All Sizes) |



Terminal Cover

| Cat. No. | Use With Fuse Base(s) |
|---------------|-----------------------|
| NHTC00 | NHB00-1-3 |



Fuse Handle

| Cat. No. | Description |
|-------------|-------------------------------|
| NHHA | Fuse Handle |
| NHSG | Fuse Handle with Safety Glove |

For maximum protection use Fuse Handle with integral safety glove, not shown.

NH STUD MOUNT Semiconductor

Semiconductor Fuses have extremely fast acting trip characteristics and provide short circuit and overload protection for diodes, SCR's etc. Current limiting, super fast blow.

Semiconductor Fuses offered comply with IEC, DIN and VDE standards and are available in two trip characteristics, defined below.

For Accessories, please refer to pg 19 for NH Fuses.

Operating Classes (VDE 0636 / IEC 269)

gR - Full Range Protection

Overload and short circuit protection.

Typical Markings: Ultra Rapid™, Silcu™, Recticur™, Protistor™, Ultra Quick™, gR

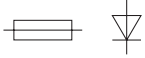

Mostly red, orange, or blue imprint.

aR - Partial Range Protection

Short circuit protection only. Faster acting than full range fuses.

Typical Markings: Ultra Rapid™, Silcu™, Recticur™, Protistor™, Ultra Quick™, aR

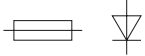

Mostly red, orange, or blue imprint.



NH00C/SM
Stud Mount



NH00C/SM-L
Stud Mount with
Microswitch Holder

Class gR

| Current/ Voltage | Cat. No. | Std. Pk. |
|--------------------------|------------|----------|
| 16/660V AC | 16SM00CGR | 3 |
| 20/660V AC | 20SM00CGR | 3 |
| 25/660V AC | 25SM00CGR | 3 |
| 32/660V AC | 32SM00CGR | 3 |
| 40/660V AC ¹ | 40SM00CGR | 3 |
| 50/660V AC ¹ | 50SM00CGR | 3 |
| 63/660V AC ¹ | 63SM00CGR | 3 |
| 80/660V AC ¹ | 80SM00CGR | 3 |
| 100/660V AC ¹ | 100SM00CGR | 3 |
| 125/660V AC ¹ | 125SM00CGR | 3 |

Class gR

| Current/ Voltage | Cat. No. | Std. Pk. |
|---------------------|--------------|----------|
| 16/660V AC | 16SM00CGR-L | 3 |
| 20/660V AC | 20SM00CGR-L | 3 |
| 25/660V AC | 25SM00CGR-L | 3 |
| 32/660V AC | 32SM00CGR-L | 3 |
| 35/660V AC | 35SM00CGR-L | 3 |
| 40/660V AC | 40SM00CGR-L | 3 |
| 50/660V AC | 50SM00CGR-L | 3 |
| 63/660V AC | 63SM00CGR-L | 3 |
| 80/660V AC | 80SM00CGR-L | 3 |
| 100/660V AC | 100SM00CGR-L | 3 |
| 125/660V AC | 125SM00CGR-L | 3 |

Class aR

| Current/ Voltage | Cat. No. | Std. Pk. |
|--------------------------|------------|----------|
| 160/660V AC ¹ | 160SM00CAR | 3 |
| 200/660V AC ¹ | 200SM00CAR | 3 |
| 250/660V AC ¹ | 250SM00CAR | 3 |
| 315/500V AC ¹ | 315SM00CAR | 3 |

Class aR

| Current/ Voltage | Cat. No. | Std. Pk. |
|---------------------|--------------|----------|
| 160/660V AC | 160SM00CAR-L | 3 |
| 180/660V AC | 180SM00CAR-L | 3 |

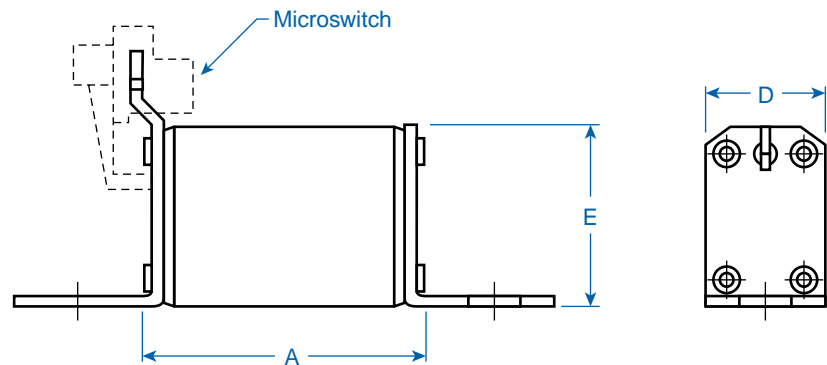

¹ UL recognized version available upon request. UL rated at 700VAC.

² Also available in operating class aR.



NH00/SM
Stud Mount

Class gR

| Current/ Voltage | Cat. No. | Std. Pk. |
|--------------------------|-----------|----------|
| 16/660V AC ² | 16SM00GR | 3 |
| 20/660V AC ² | 20SM00GR | 3 |
| 25/660V AC ² | 25SM00GR | 3 |
| 32/660V AC ² | 32SM00GR | 3 |
| 35/660V AC ² | 35SM00GR | 3 |
| 40/660V AC ² | 40SM00GR | 3 |
| 50/660V AC ² | 50SM00GR | 3 |
| 63/660V AC ² | 63SM00GR | 3 |
| 80/660V AC ² | 80SM00GR | 3 |
| 100/660V AC ² | 100SM00GR | 3 |
| 125/660V AC ² | 125SM00GR | 3 |

Class aR

| | | |
|--------------------------|-----------|---|
| 160/660V AC ¹ | 160SM00AR | 3 |
| 200/660V AC ¹ | 200SM00AR | 3 |
| 250/660V AC ¹ | 250SM00AR | 3 |
| 315/660V AC ¹ | 315SM00AR | 3 |
| 350/660V AC ¹ | 350SM00AR | 3 |
| 400/660V AC | 400SM00AR | 3 |



NH00/SM-L
Stud Mount with
Microswitch Holder

Class gR

| Current/ Voltage | Cat. No. | Std. Pk. |
|--------------------------|-------------|----------|
| 6/660V AC ² | 6SM00GR-L | 3 |
| 10/660V AC ² | 10SM00GR-L | 3 |
| 16/660V AC ² | 16SM00GR-L | 3 |
| 20/660V AC ² | 20SM00GR-L | 3 |
| 25/660V AC ² | 25SM00GR-L | 3 |
| 32/660V AC ² | 32SM00GR-L | 3 |
| 35/660V AC ² | 35SM00GR-L | 3 |
| 40/660V AC ² | 40SM00GR-L | 3 |
| 50/660V AC ² | 50SM00GR-L | 3 |
| 63/660V AC ² | 63SM00GR-L | 3 |
| 80/660V AC ² | 80SM00GR-L | 3 |
| 100/660V AC ² | 100SM00GR-L | 3 |
| 125/660V AC ² | 125SM00GR-L | 3 |

Class aR

| | | |
|-------------|-------------|---|
| 160/660V AC | 160SM00AR-L | 3 |
| 200/660V AC | 200SM00AR-L | 3 |
| 250/660V AC | 250SM00AR-L | 3 |
| 315/660V AC | 315SM00AR-L | 3 |
| 350/660V AC | 350SM00AR-L | 3 |
| 400/660V AC | 400SM00AR-L | 3 |



NH0/SM-L
Stud Mount with
Microswitch Holder

Class gR

| Current/ Voltage | Cat. No. | Std. Pk. |
|---------------------|------------|----------|
| 6/660V AC | 6SM0GR-L | 3 |
| 10/660V AC | 10SM0GR-L | 3 |
| 16/660V AC | 16SM0GR-L | 3 |
| 20/660V AC | 20SM0GR-L | 3 |
| 25/660V AC | 25SM0GR-L | 3 |
| 32/660V AC | 32SM0GR-L | 3 |
| 35/660V AC | 35SM0GR-L | 3 |
| 40/660V AC | 40SM0GR-L | 3 |
| 50/660V AC | 50SM0GR-L | 3 |
| 63/660V AC | 63SM0GR-L | 3 |
| 80/660V AC | 80SM0GR-L | 3 |
| 100/660V AC | 100SM0GR-L | 3 |
| 125/660V AC | 125SM0GR-L | 3 |

Class aR

| | | |
|-------------|------------|---|
| 160/660V AC | 160SM0AR-L | 3 |
|-------------|------------|---|

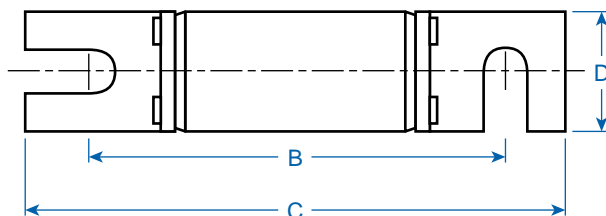

**Approximate Dimensions
Stud Mount mm (in.)***

| Dim. | NHC00 | NH00 | NH0 |
|------|------------|------------|------------|
| A | 55 (2.17) | 55 (2.17) | 69 (2.72) |
| B | 80 (3.15) | 80 (3.15) | 97 (3.82) |
| C | 100 (3.94) | 100 (3.94) | 120 (4.72) |
| D | 20 (0.79) | 28 (1.10) | 28 (1.10) |
| E | 39 (1.54) | 50 (1.97) | 50 (1.97) |

*Dimensions to DIN 43653

ITALIAN

Cylinder Fuses to Italian standards are typically used for machinery imported from Italy.

They are available in four sizes with a current range from 2 to 100 Amps. These fuses have metal caps at both ends, a ceramic body, and a blown fuse indicator.

Operating Class
(IEC269 / CEI 32)

gI - Line Protection

Slow Blow, typically used for power distribution or resistive loads.

Typical Marking: gl



8.5 x 32 (C)

| Current/ Voltage | Cat No. | Std. Pk. |
|---------------------|---------|-------------|
| 2/380V AC | 2C/T | 10 |
| 4/380V AC | 4C/T | 10 |
| 6/380V AC | 6C/T | 10 |
| 10/380V AC | 10C/T | 10 |
| 16/380V AC | 16C/T | 10 |
| 20/380V AC | 20C/T | 10 |
| 25/380V AC | 25C/T | 10 |



9 x 36 (C1)

| Current/ Voltage | Cat No. | Std. Pk. |
|---------------------|---------|-------------|
| 2/380V AC | 2C1/T1 | 10 |
| 4/380V AC | 4C1/T1 | 10 |
| 6/380V AC | 6C1/T1 | 10 |
| 10/380V AC | 10C1/T1 | 10 |
| 16/380V AC | 16C1/T1 | 10 |
| 20/380V AC | 20C1/T1 | 10 |
| 25/380V AC | 25C1/T1 | 10 |
| 30/380V AC | 30C1/T1 | 10 |
| 35/380V AC | 35C1/T1 | 10 |
| 40/380V AC | 40C1/T1 | 10 |

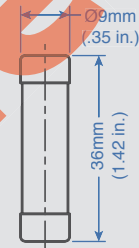
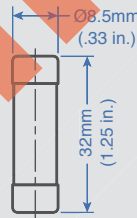

13 x 50 (C2)

| Current/ Voltage | Cat No. | Std. Pk. |
|---------------------|---------|-------------|
| 20/380V AC | 20C2/T2 | 10 |
| 25/380V AC | 25C2/T2 | 10 |
| 30/380V AC | 30C2/T2 | 10 |
| 35/380V AC | 35C2/T2 | 10 |
| 40/380V AC | 40C2/T2 | 10 |
| 50/380V AC | 50C2/T2 | 10 |



24 x 50 (C3)

| Current/ Voltage | Cat No. | Std. Pk. |
|---------------------|----------|-------------|
| 50/380V AC | 50C3/T3 | 10 |
| 63/380V AC | 63C3/T3 | 10 |
| 80/380V AC | 80C3/T3 | 10 |
| 100/380V AC | 100C3/T3 | 10 |

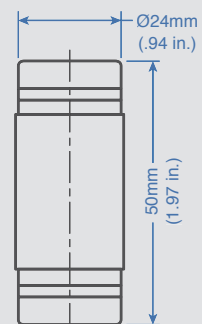
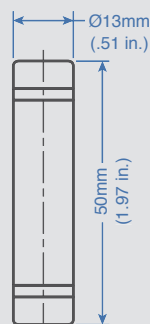

BRITISH

British fuses are typically used for industrial and general applications to protect cable and motor circuits. They are available with four different mounting plates. The most common sizes are shown here. Please consult Altech if you require sizes not listed.

Operating Class
(IEC 269 / BS 88)

gG - Line Protection

Typically used for cable and motor circuits.

Typical Marking: gG / Q1



NS



NIT (A1)

| Current/ Voltage | Cat. No. | Std. Pk. |
|---------------------|---------------|-------------|
| 2/415V AC | 2NSGG | 10 |
| 4/415V AC | 4NSGG | 10 |
| 6/415V AC | 6NSGG | 10 |
| 10/415V AC | 10NSGG | 10 |
| 16/415V AC | 16NSGG | 10 |
| 20/415V AC | 20NSGG | 10 |
| 25/415V AC | 25NSGG | 10 |
| 32/415V AC | 32NSGG | 10 |

| Current/ Voltage | Cat. No. | Std. Pk. |
|---------------------|----------------|-------------|
| 2/550V AC | 2NITGG | 10 |
| 4/550V AC | 4NITGG | 10 |
| 6/550V AC | 6NITGG | 10 |
| 10/550V AC | 10NITGG | 10 |
| 16/550V AC | 16NITGG | 10 |
| 20/550V AC | 20NITGG | 10 |
| 25/550V AC | 25NITGG | 10 |
| 32/550V AC | 32NITGG | 10 |

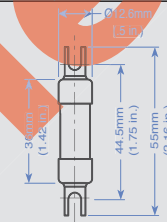
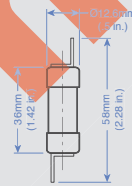

TIA (A2)



TIS (A3)

| Current/ Voltage | Cat. No. | Std. Pk. |
|---------------------|----------------|-------------|
| 2/550V AC | 2TIAGG | 10 |
| 4/550V AC | 4TIAGG | 10 |
| 6/550V AC | 6TIAGG | 10 |
| 10/550V AC | 10TIAGG | 10 |
| 16/550V AC | 16TIAGG | 10 |
| 20/550V AC | 20TIAGG | 10 |
| 25/550V AC | 25TIAGG | 10 |
| 32/550V AC | 32TIAGG | 10 |

| Current/ Voltage | Cat. No. | Std. Pk. |
|---------------------|----------------|-------------|
| 35/550V AC | 35TISGG | 10 |
| 40/550V AC | 40TISGG | 10 |
| 50/550V AC | 50TISGG | 10 |
| 63/550V AC | 63TISGG | 10 |

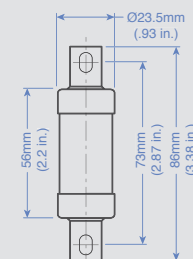
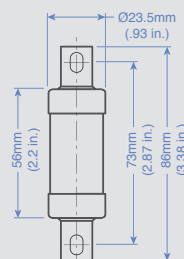

BRITISH SEMICONDUCTOR

British Semiconductor fuses are typically used for industrial applications to protect semiconductors like diodes, SCR's, etc.

They are available in single and double body units with multiple diameters and fixing centers. The fuses have mounting tabs for bolt mounting.

Operating Class (IEC269/BS88:4)

aR - Semiconductor Protection

Partial Range, short circuit protection.



8.4mm (0.33in) (D)

| Ordering Information | Current/ Voltage | Cat. No. | Std. Pk. |
|--|---------------------|-------------|----------|
| 38mm (1.50 in.) Fixing Center (F) Fuse | 5/240V AC | 5B8x38SC-2 | 10 |
| | 10/240V AC | 10B8x38SC-2 | 10 |
| | 15/240V AC | 15B8x38SC-2 | 10 |
| | 20/240V AC | 20B8x38SC-2 | 10 |
| 41mm (1.61 in.) Fixing Center (F) Fuse | | | |
| 57-62mm (2.24-2.44 in.) Fixing Center (F) Fuse | | | |
| 62mm (2.44 in.) Fixing Center (F) Fuse | | | |
| 63.5mm (2.50 in.) Fixing Center (F) Fuse | 5/660V AC | 5B8x63SC-6 | 10 |
| | 10/660V AC | 10B8x63SC-6 | 10 |
| | 15/660V AC | 15B8x63SC-6 | 10 |
| | 20/660V AC | 20B8x63SC-6 | 10 |
| 80-86mm (3.15-3.39 in.) Fixing Center (F) Fuse | | | |

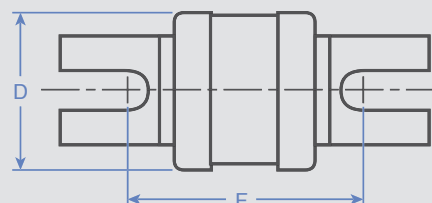

No Longer Available



17.5mm (0.69in) (D)



35mm (1.38in) (D)



Double 35mm (1.38in) (D)

| Current/ Voltage | Cat. No. | Std. Pk. | Current/ Voltage | Cat. No. | Std. Pk. | Current/ Voltage | Cat. No. | Std. Pk. |
|---------------------|---------------|----------|---------------------|---------------|----------|---------------------|----------------|----------|
| 25/240VAC | 25B17x41SC-2 | 10 | 150/240VAC | 150B35x57SC-2 | 3 | 300/240VAC | 300BD35x57SC-2 | 1 |
| 50/240VAC | 50B17x41SC-2 | 10 | 200/240VAC | 200B35x57SC-2 | 3 | 350/240VAC | 350BD35x57SC-2 | 1 |
| 75/240VAC | 75B17x41SC-2 | 10 | 300/240VAC | 300B35x57SC-2 | 3 | 400/240VAC | 400BD35x57SC-2 | 1 |
| 100/240VAC | 100B17x41SC-2 | 10 | | | | 450/240VAC | 450BD35x57SC-2 | 1 |
| 125/240VAC | 125B17x41SC-2 | 10 | | | | 500/240VAC | 500BD35x57SC-2 | 1 |
| 150/240VAC | 150B17x41SC-2 | 10 | | | | 600/240VAC | 600BD35x57SC-2 | 1 |
| 25/660VAC | 25B17x62SC-6 | 10 | | | | | | |
| 50/660VAC | 50B17x62SC-6 | 10 | | | | | | |
| 75/660VAC | 75B17x62SC-6 | 10 | | | | | | |
| | | | 100/660VAC | 100B35x80SC-6 | 3 | 300/660VAC | 300B35x80SC-6 | 1 |
| | | | 150/660VAC | 150B35x80SC-6 | 3 | 400/660VAC | 400B35x80SC-6 | 1 |
| | | | 200/660VAC | 200B35x80SC-6 | 3 | 450/660VAC | 450B35x80SC-6 | 1 |
| | | | 250/660VAC | 250B35x80SC-6 | 3 | 500/660VAC | 600B35x80SC-6 | 1 |

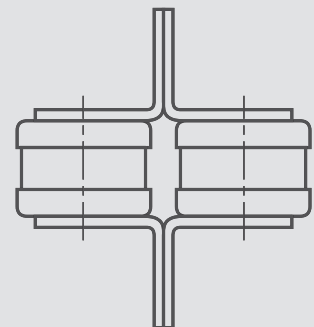
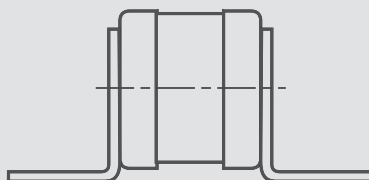

SQUARE BODY Semiconductor

Square Body Fuses provide short circuit protection for semiconductor devices such as diodes, SCR's, etc.

Square Body Fuses are available in three sizes with threaded holes in the metal end caps. They can be supplied with a Flap Indicator or a Center Indicator for visual trip indication.

The Center Indicator has a provision for mounting an Adapter and Microswitch for remote indication.

Semiconductor Fuses offered comply with IEC, DIN and VDE.

Operating Class

aR - Partial Range Protection

(VDE 0636 / IEC 269)

Short circuit protection only.

Typical Markings: *Ultra Rapid™*,
Silcu™, *Protistor™*, aR

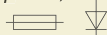

Mostly red, orange, or blue imprint.



Square Body With Threaded Holes Size 1 Class aR

Square Body With Threaded Holes Size 2 Class aR

| Ordering Information | Current/ Voltage | Cat. No. | Dim. | Std. Pk. | Current/ Voltage | Cat. No. | Dim. | Std. Pk. | |
|--|--|-------------|------------|----------|---------------------|-------------|------------|----------|---|
| Fuse with Flap Indicator up to 660V AC | 80/660V AC | 80SB1F0-6 | A | 1 | 400/660V AC | 400SB2F0-6 | C | 1 | |
| | 100/660V AC | 100SB1F0-6 | A | 1 | 450/660V AC | 450SB2F0-6 | C | 1 | |
| | 125/660V AC | 125SB1F0-6 | A | 1 | 500/660V AC | 500SB2F0-6 | C | 1 | |
| | 160/660V AC | 160SB1F0-6 | A | 1 | 550/660V AC | 550SB2F0-6 | C | 1 | |
| | 200/660V AC | 200SB1F0-6 | A | 1 | 630/660V AC | 630SB2F0-6 | C | 1 | |
| | 250/660V AC | 250SB1F0-6 | A | 1 | 700/660V AC | 700SB2F0-6 | C | 1 | |
| | 315/660V AC | 315SB1F0-6 | A | 1 | | | | | |
| | 350/660V AC | 350SB1F0-6 | A | 1 | | | | | |
| | 400/660V AC | 400SB1F0-6 | A | 1 | | | | | |
| | 450/660V AC | 450SB1F0-6 | A | 1 | | | | | |
| | 500/660V AC | 500SB1F0-6 | A | 1 | | | | | |
| | Fuse with Center Indicator¹ up to 660V AC | 80/660V AC | 80SB1C0-6 | A | 1 | 400/660V AC | 400SB2C0-6 | C | 1 |
| | | 100/660V AC | 100SB1C0-6 | A | 1 | 450/660V AC | 450SB2C0-6 | C | 1 |
| 125/660V AC | | 125SB1C0-6 | A | 1 | 500/660V AC | 500SB2C0-6 | C | 1 | |
| 160/660V AC | | 160SB1C0-6 | A | 1 | 550/660V AC | 550SB2C0-6 | C | 1 | |
| 200/660V AC | | 200SB1C0-6 | A | 1 | 630/660V AC | 630SB2C0-6 | C | 1 | |
| 250/660V AC | | 250SB1C0-6 | A | 1 | 700/660V AC | 700SB2C0-6 | C | 1 | |
| 315/660V AC | | 315SB1C0-6 | A | 1 | | | | | |
| 350/660V AC | | 350SB1C0-6 | A | 1 | | | | | |
| 400/660V AC | | 400SB1C0-6 | A | 1 | | | | | |
| 450/660V AC | | 450SB1C0-6 | A | 1 | | | | | |
| 500/660V AC | 500SB1C0-6 | A | 1 | | | | | | |
| Fuse with Flap Indicator up to 1000V AC | 200/1000V AC | 200SB1F0-1 | B | 1 | 315/1000V AC | 315SB2F0-1 | D | 1 | |
| | 250/1000V AC | 250SB1F0-1 | B | 1 | 350/1000V AC | 350SB2F0-1 | D | 1 | |
| | 315/1000V AC | 315SB1F0-1 | B | 1 | 400/1000V AC | 400SB2F0-1 | D | 1 | |
| | 350/1000V AC | 350SB1F0-1 | B | 1 | 450/1000V AC | 450SB2F0-1 | D | 1 | |
| | 400/1000V AC | 400SB1F0-1 | B | 1 | 500/1000V AC | 500SB2F0-1 | D | 1 | |
| | 450/1000V AC | 450SB1F0-1 | B | 1 | 556/1000V AC | 556SB2F0-1 | D | 1 | |
| | 500/1000V AC | 500SB1F0-1 | B | 1 | 630/1000V AC | 630SB2F0-1 | D | 1 | |
| | | | | | | | | | |
| Fuse with Center Indicator¹ up to 1000V AC | 200/1000V AC | 200SB1C0-1 | B | 1 | 315/1000V AC | 315SB2C0-1 | D | 1 | |
| | 250/1000V AC | 250SB1C0-1 | B | 1 | 350/1000V AC | 350SB2C0-1 | D | 1 | |
| | 315/1000V AC | 315SB1C0-1 | B | 1 | 400/1000V AC | 400SB2C0-1 | D | 1 | |
| | 350/1000V AC | 350SB1C0-1 | B | 1 | 450/1000V AC | 450SB2C0-1 | D | 1 | |
| | 400/1000V AC | 400SB1C0-1 | B | 1 | 500/1000V AC | 500SB2C0-1 | D | 1 | |
| | 450/1000V AC | 450SB1C0-1 | B | 1 | 556/1000V AC | 556SB2C0-1 | D | 1 | |
| | 500/1000V AC | 500SB1C0-1 | B | 1 | 630/1000V AC | 630SB2C0-1 | D | 1 | |
| | | | | | | | | | |
| Adapter for Microswitch¹ See installation on pg 27. | 660V | SBA6 | | 1 | 660V | SBA6 | | 1 | |
| | 1000V | SBA1 | | 1 | 1000V | SBA1 | | 1 | |
| Microswitch² (SPDT) See installation on pg 27. | 6/250V AC | SBMS | | 1 | 6/250V AC | SBMS | | 1 | |

¹ We recommend the Adapter be used on Fuses with Center Indicators whether or not a Microswitch is used.

² An Adapter is required to mount the Microswitch. (Adapters will not fit on fuses with Flap Indicators)



**Square Body
With Threaded Holes
Size 3
Class aR**

| Current/ Voltage | Cat. No. | Dim. | Std. Pk. |
|---------------------|-------------|------|----------|
| 500/660V AC | 500SB3F0-6 | E | 1 |
| 550/660V AC | 550SB3F0-6 | E | 1 |
| 630/660V AC | 630SB3F0-6 | E | 1 |
| 700/660V AC | 700SB3F0-6 | E | 1 |
| 800/660V AC | 800SB3F0-6 | E | 1 |
| 900/660V AC | 900SB3F0-6 | E | 1 |
| 1000/660V AC | 1000SB3F0-6 | E | 1 |

| | | | |
|--------------|-------------|---|---|
| 500/660V AC | 500SB3C0-6 | E | 1 |
| 550/660V AC | 550SB3C0-6 | E | 1 |
| 630/660V AC | 630SB3C0-6 | E | 1 |
| 700/660V AC | 700SB3C0-6 | E | 1 |
| 800/660V AC | 800SB3C0-6 | E | 1 |
| 900/660V AC | 900SB3C0-6 | E | 1 |
| 1000/660V AC | 1000SB3C0-6 | E | 1 |

| | | | |
|---------------|-------------|---|---|
| 500/1000V AC | 500SB3F0-1 | F | 1 |
| 550/1000V AC | 550SB3F0-1 | F | 1 |
| 630/1000V AC | 630SB3F0-1 | F | 1 |
| 700/1000V AC | 700SB3F0-1 | F | 1 |
| 800/1000V AC | 800SB3F0-1 | F | 1 |
| 1000/1000V AC | 1000SB3F0-1 | F | 1 |

| | | | |
|---------------|-------------|---|---|
| 500/1000V AC | 500SB3C0-1 | F | 1 |
| 550/1000V AC | 550SB3C0-1 | F | 1 |
| 630/1000V AC | 630SB3C0-1 | F | 1 |
| 700/1000V AC | 700SB3C0-1 | F | 1 |
| 800/1000V AC | 800SB3C0-1 | F | 1 |
| 1000/1000V AC | 1000SB3C0-1 | F | 1 |

| | | |
|-------|------|---|
| 660V | SBA6 | 1 |
| 1000V | SBA1 | 1 |

| | | |
|-----------|------|---|
| 6/250V AC | SBMS | 1 |
|-----------|------|---|

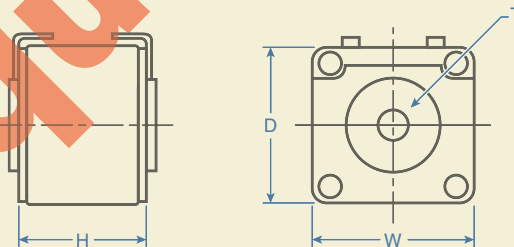
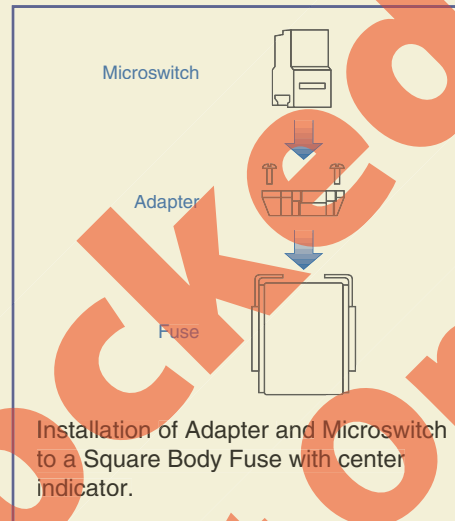

**Approximate Dimensions
for Square Body Fuses mm (in.)***

| Fuse Size/Dim. | Body Width (W) | Body Height (H) | Body Depth (D) | Thread Dia. (T) |
|----------------|----------------|-----------------|----------------|-----------------|
| 1/A | 51 (2.00) | 52 (2.05) | 51 (2.00) | M8 (.314) |
| 1/B | 51 (2.00) | 75 (2.95) | 51 (2.00) | M8 (.314) |
| 2/C | 60 (2.36) | 52 (2.05) | 60 (2.36) | M10 (.393) |
| 2/D | 60 (2.36) | 75 (2.95) | 60 (2.36) | M10 (.393) |
| 3/E | 75 (2.95) | 52 (2.05) | 75 (2.95) | M12 (.472) |
| 3/F | 75 (2.95) | 75 (2.95) | 75 (2.95) | M12 (.472) |

*Dimensions to DIN 43653

SQUARE BODY Semiconductor

Square Body Fuses provide short circuit protection for semiconductor devices such as diodes, SCR's, etc.

Square Body Fuses are available in three sizes with knife blades in two fixing lengths, 80mm (3.15 in.) and 110mm (4.33 in.). They can be supplied with a Flap Indicator or a Center Indicator for visual trip indication. The Center Indicator has a provision for mounting an Adapter and Microswitch for remote indication.



Semiconductor Fuses offered comply with IEC, DIN and VDE.

Operating Class

aR - Partial Range Protection

(VDE 0636 / IEC 269)

Short circuit protection only.

Typical Markings: Ultra Rapid™, Silcu™, Protistor™, aR,  

Mostly red, orange, or blue imprint.



Square Body
With Knife Blade 80mm (3.15 in.)
Size 1
Class aR

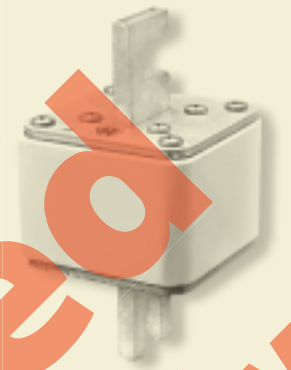

Square Body
With Knife Blade 80mm (3.15 in.)
Size 2
Class aR

| Ordering Information | Current/ Voltage | Cat. No. | Std. Pk. | Current/ Voltage | Cat. No. | Std. Pk. | |
|--|--|-------------|------------|---------------------|-------------|------------|---|
| Fuse with Flap Indicator up to 660V AC | 80/660V AC | 80SB1F8-6 | 1 | 400/660V AC | 400SB2F8-6 | 1 | |
| | 100/660V AC | 100SB1F8-6 | 1 | 450/660V AC | 450SB2F8-6 | 1 | |
| | 125/660V AC | 125SB1F8-6 | 1 | 500/660V AC | 500SB2F8-6 | 1 | |
| | 160/660V AC | 160SB1F8-6 | 1 | 550/660V AC | 550SB2F8-6 | 1 | |
| | 200/660V AC | 200SB1F8-6 | 1 | 630/660V AC | 630SB2F8-6 | 1 | |
| | 250/660V AC | 250SB1F8-6 | 1 | 700/660V AC | 700SB2F8-6 | 1 | |
| | 315/660V AC | 315SB1F8-6 | 1 | | | | |
| | 350/660V AC | 350SB1F8-6 | 1 | | | | |
| | 400/660V AC | 400SB1F8-6 | 1 | | | | |
| | 450/660V AC | 450SB1F8-6 | 1 | | | | |
| | 500/660V AC | 500SB1F8-6 | 1 | | | | |
| | Fuse with Center Indicator¹ up to 660V AC | 80/660V AC | 80SB1C8-6 | 1 | 400/660V AC | 400SB2C8-6 | 1 |
| | | 100/660V AC | 100SB1C8-6 | 1 | 450/660V AC | 450SB2C8-6 | 1 |
| 125/660V AC | | 125SB1C8-6 | 1 | 500/660V AC | 500SB2C8-6 | 1 | |
| 160/660V AC | | 160SB1C8-6 | 1 | 550/660V AC | 550SB2C8-6 | 1 | |
| 200/660V AC | | 200SB1C8-6 | 1 | 630/660V AC | 630SB2C8-6 | 1 | |
| 250/660V AC | | 250SB1C8-6 | 1 | 700/660V AC | 700SB2C8-6 | 1 | |
| 315/660V AC | | 315SB1C8-6 | 1 | | | | |
| 350/660V AC | | 350SB1C8-6 | 1 | | | | |
| 400/660V AC | | 400SB1C8-6 | 1 | | | | |
| 450/660V AC | | 450SB1C8-6 | 1 | | | | |
| 500/660V AC | | 500SB1C8-6 | 1 | | | | |
| Adapter¹ (See installation on page 29) | | 660V | SBA6 | 1 | 660V | SBA6 | 1 |
| Microswitch² (SPDT) See installation on pg 29 | | 6/250V AC | SBMS | 1 | 6/250V AC | SBMS | 1 |

¹ We recommend the Adapter be used on Fuses with Center Indicators whether or not a Microswitch is used.

² An Adapter is required to mount the Microswitch. (Adapters will not fit on fuses with Flap Indicators)



Square Body
With Knife Blade 80mm (3.15 in.)
Size 3
Class aR

| Current/ Voltage | Cat. No. | Std. Pk. |
|---------------------|-------------|----------|
| 500/660V AC | 500SB3F8-6 | 1 |
| 550/660V AC | 550SB3F8-6 | 1 |
| 630/660V AC | 630SB3F8-6 | 1 |
| 700/660V AC | 700SB3F8-6 | 1 |
| 800/660V AC | 800SB3F8-6 | 1 |
| 900/660V AC | 900SB3F8-6 | 1 |
| 1000/660V AC | 1000SB3F8-6 | 1 |

| | | |
|--------------|-------------|---|
| 500/660V AC | 500SB3C8-6 | 1 |
| 550/660V AC | 550SB3C8-6 | 1 |
| 630/660V AC | 630SB3C8-6 | 1 |
| 700/660V AC | 700SB3C8-6 | 1 |
| 800/660V AC | 800SB3C8-6 | 1 |
| 900/660V AC | 900SB3C8-6 | 1 |
| 1000/660V AC | 1000SB3C8-6 | 1 |

| | | |
|-----------|------|---|
| 660V | SBA6 | 1 |
| 6/250V AC | SBMS | 1 |

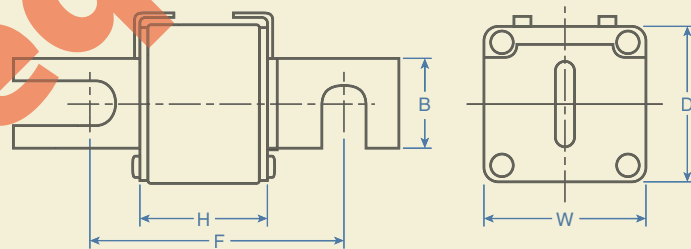
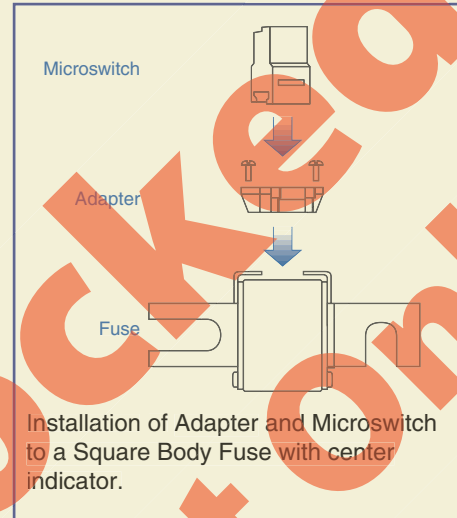

Approximate Dimensions
for Square Body Fuses mm (in.)*

| Fuse Size | Body Width (W) | Body Depth (D) | Body Height (H) | Blade Depth (B) | Fixing Length** (F) |
|-----------|----------------|----------------|-----------------|-----------------|---------------------|
| 1 | 51 (2.00) | 50 (1.97) | 50 (1.97) | 25 (0.98) | 80 (3.15) |
| 2 | 60 (2.36) | 60 (2.36) | 50 (1.97) | 25 (0.98) | 80 (3.15) |
| 3 | 75 (2.95) | 75 (2.95) | 50 (1.97) | 30 (1.18) | 80 (3.15) |

* Dimensions to DIN 43653

** Can be between 78mm (3.07 in.) and 80mm (3.15 in.)

SQUARE BODY Semiconductor

Square Body Fuses provide short circuit protection for semiconductor devices such as diodes, SCR's, etc. Fuses with knife blades are typically used in high power applications of 80 to 1000A at 660 or 1000V.



Square Body Fuses are available in three sizes with knife blades in two fixing lengths, 80mm (3.15 in.) and 110mm (4.33 in.). They can be supplied with a Flap Indicator or a Center Indicator for visual trip indication. The Center Indicator has a provision for mounting an Adapter and Microswitch for remote indication. Semiconductor Fuses offered comply with IEC, DIN and VDE.

Operating Class

aR - Partial Range Protection

(VDE 0636 / IEC 269)

Short circuit protection only.

Typical Markings: Ultra Rapid™, Silcu™, Protistor™, aR,  

Mostly red, orange, or blue imprint.



Square Body
With Knife Blade 110mm (4.33 in.)
Size 1
Class aR

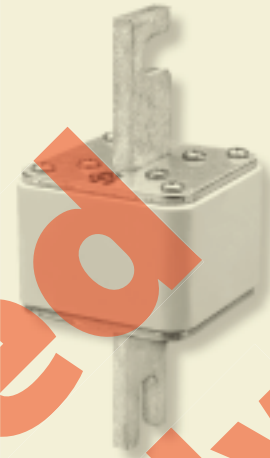

Square Body
With Knife Blade 110mm (4.33 in.)
Size 2
Class aR

| Ordering Information | Current/ Voltage | Cat. No. | Dim. | Std. Pk. | Current/ Voltage | Cat. No. | Dim. | Std. Pk. | |
|--|--|--------------|------------|----------|---------------------|--------------|------------|----------|---|
| Fuse with Flap Indicator up to 660V AC | 80/660V AC | 80SB1F1-6 | A | 1 | 400/660V AC | 400SB2F1-6 | C | 1 | |
| | 100/660V AC | 100SB1F1-6 | A | 1 | 450/660V AC | 450SB2F1-6 | C | 1 | |
| | 125/660V AC | 125SB1F1-6 | A | 1 | 500/660V AC | 500SB2F1-6 | C | 1 | |
| | 160/660V AC | 160SB1F1-6 | A | 1 | 550/660V AC | 550SB2F1-6 | C | 1 | |
| | 200/660V AC | 200SB1F1-6 | A | 1 | 630/660V AC | 630SB2F1-6 | C | 1 | |
| | 250/660V AC | 250SB1F1-6 | A | 1 | 700/660V AC | 700SB2F1-6 | C | 1 | |
| | 315/660V AC | 315SB1F1-6 | A | 1 | | | | | |
| | 350/660V AC | 350SB1F1-6 | A | 1 | | | | | |
| | 400/660V AC | 400SB1F1-6 | A | 1 | | | | | |
| | 450/660V AC | 450SB1F1-6 | A | 1 | | | | | |
| | 500/660V AC | 500SB1F1-6 | A | 1 | | | | | |
| | Fuse with Center Indicator ¹ up to 660V AC | 80/660V AC | 80SB1C1-6 | A | 1 | 400/660V AC | 400SB2C1-6 | C | 1 |
| | | 100/660V AC | 100SB1C1-6 | A | 1 | 450/660V AC | 450SB2C1-6 | C | 1 |
| 125/660V AC | | 125SB1C1-6 | A | 1 | 500/660V AC | 500SB2C1-6 | C | 1 | |
| 160/660V AC | | 160SB1C1-6 | A | 1 | 550/660V AC | 550SB2C1-6 | C | 1 | |
| 200/660V AC | | 200SB1C1-6 | A | 1 | 630/660V AC | 630SB2C1-6 | C | 1 | |
| 250/660V AC | | 250SB1C1-6 | A | 1 | 700/660V AC | 700SB2C1-6 | C | 1 | |
| 315/660V AC | | 315SB1C1-6 | A | 1 | | | | | |
| 350/660V AC | | 350SB1C1-6 | A | 1 | | | | | |
| 400/660V AC | | 400SB1C1-6 | A | 1 | | | | | |
| 450/660V AC | | 450SB1C1-6 | A | 1 | | | | | |
| 500/660V AC | | 500SB1C1-6 | A | 1 | | | | | |
| Fuse with Flap Indicator up to 1000V AC | | 200/1000V AC | 200SB1F1-1 | B | 1 | 315/1000V AC | 315SB2F1-1 | D | 1 |
| | | 250/1000V AC | 250SB1F1-1 | B | 1 | 350/1000V AC | 350SB2F1-1 | D | 1 |
| | 315/1000V AC | 315SB1F1-1 | B | 1 | 400/1000V AC | 400SB2F1-1 | D | 1 | |
| | 350/1000V AC | 350SB1F1-1 | B | 1 | 450/1000V AC | 450SB2F1-1 | D | 1 | |
| | 400/1000V AC | 400SB1F1-1 | B | 1 | 500/1000V AC | 500SB2F1-1 | D | 1 | |
| | 450/1000V AC | 450SB1F1-1 | B | 1 | 556/1000V AC | 556SB2F1-1 | D | 1 | |
| | 500/1000V AC | 500SB1F1-1 | B | 1 | 630/1000V AC | 630SB2F1-1 | D | 1 | |
| | | | | | | | | | |
| | | | | | | | | | |
| Fuse with Center Indicator ¹ up to 1000V AC | 200/1000V AC | 200SB1C1-1 | B | 1 | 315/1000V AC | 315SB2C1-1 | D | 1 | |
| | 250/1000V AC | 250SB1C1-1 | B | 1 | 350/1000V AC | 350SB2C1-1 | D | 1 | |
| | 315/1000V AC | 315SB1C1-1 | B | 1 | 400/1000V AC | 400SB2C1-1 | D | 1 | |
| | 350/1000V AC | 350SB1C1-1 | B | 1 | 450/1000V AC | 450SB2C1-1 | D | 1 | |
| | 400/1000V AC | 400SB1C1-1 | B | 1 | 500/1000V AC | 500SB2C1-1 | D | 1 | |
| | 450/1000V AC | 450SB1C1-1 | B | 1 | 556/1000V AC | 556SB2C1-1 | D | 1 | |
| | 500/1000V AC | 500SB1C1-1 | B | 1 | 630/1000V AC | 630SB2C1-1 | D | 1 | |
| | | | | | | | | | |
| | | | | | | | | | |
| Adapter ¹ See installation on pg 31 | 660V | SBA6 | | 1 | 660V | SBA6 | | 1 | |
| | 1000V | SBA1 | | 1 | 1000V | SBA1 | | 1 | |
| Microswitch ² (SPDT) See installation on pg 31 | 6/250V AC | SBMS | | 1 | 6/250V AC | SBMS | | 1 | |

¹ We recommend the Adapter be used on Fuses with Center Indicators whether or not a Microswitch is used.

² An Adapter is required to mount the Microswitch. (Adapters will not fit on fuses with Flap Indicators)



**Square Body
With Knife Blade 110mm (4.33 in.)
Size 3
Class aR**

| Current/ Voltage | Cat. No. | Dim. | Std. Pk. |
|---------------------|-------------|------|----------|
| 500/660V AC | 500SB3F1-6 | E | 1 |
| 550/660V AC | 550SB3F1-6 | E | 1 |
| 630/660V AC | 630SB3F1-6 | E | 1 |
| 700/660V AC | 700SB3F1-6 | E | 1 |
| 800/660V AC | 800SB3F1-6 | E | 1 |
| 900/660V AC | 900SB3F1-6 | E | 1 |
| 1000/660V AC | 1000SB3F1-6 | E | 1 |

| | | | |
|--------------|-------------|---|---|
| 500/660V AC | 500SB3C1-6 | E | 1 |
| 550/660V AC | 550SB3C1-6 | E | 1 |
| 630/660V AC | 630SB3C1-6 | E | 1 |
| 700/660V AC | 700SB3C1-6 | E | 1 |
| 800/660V AC | 800SB3C1-6 | E | 1 |
| 900/660V AC | 900SB3C1-6 | E | 1 |
| 1000/660V AC | 1000SB3C1-6 | E | 1 |

| | | | |
|---------------|-------------|---|---|
| 500/1000V AC | 500SB3F1-1 | F | 1 |
| 550/1000V AC | 550SB3F1-1 | F | 1 |
| 630/1000V AC | 630SB3F1-1 | F | 1 |
| 700/1000V AC | 700SB3F1-1 | F | 1 |
| 800/1000V AC | 800SB3F1-1 | F | 1 |
| 1000/1000V AC | 1000SB3F1-1 | F | 1 |

| | | | |
|---------------|-------------|---|---|
| 500/1000V AC | 500SB3C1-1 | F | 1 |
| 550/1000V AC | 550SB3C1-1 | F | 1 |
| 630/1000V AC | 630SB3C1-1 | F | 1 |
| 700/1000V AC | 700SB3C1-1 | F | 1 |
| 800/1000V AC | 800SB3C1-1 | F | 1 |
| 1000/1000V AC | 1000SB3C1-1 | F | 1 |

| | | |
|-------|------|---|
| 660V | SBA6 | 1 |
| 1000V | SBA1 | 1 |

| | | |
|-----------|------|---|
| 6/250V AC | SBMS | 1 |
|-----------|------|---|

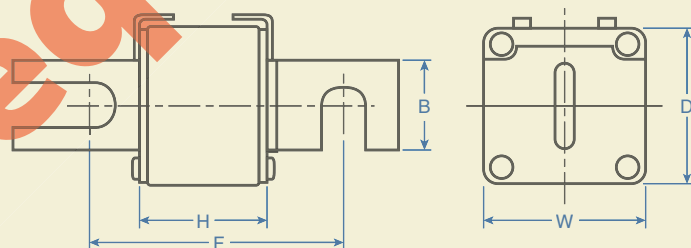
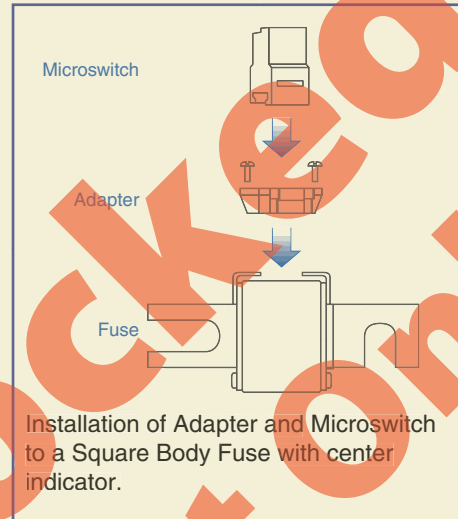

**Approximate Dimensions
for Square Body Fuses mm(in.)***

| Fuse Size/Dim. | Body Width (W) | Body Depth (D) | Body Height (H) | Blade Depth (B) | Fixing Length** (F) |
|----------------|----------------|----------------|-----------------|-----------------|---------------------|
| 1/A | 51 (2.01) | 51 (2.01) | 50 (1.97) | 25 (.98) | 110 (4.33) |
| 1/B | 51 (2.01) | 51 (2.01) | 73 (2.87) | 25 (.98) | 110 (4.33) |
| 2/C | 60 (2.36) | 60 (2.36) | 50 (1.97) | 25 (.98) | 110 (4.33) |
| 2/D | 60 (2.36) | 60 (2.36) | 73 (2.87) | 25 (.98) | 110 (4.33) |
| 3/E | 75 (2.95) | 75 (2.95) | 50 (1.97) | 30 (1.18) | 110 (4.33) |
| 3/F | 75 (2.95) | 75 (2.95) | 73 (2.87) | 30 (1.18) | 110 (4.33) |

*Dimensions to DIN 43653

** Can be between 108mm (4.25) and 110mm (4.33)

HIGH VOLTAGE

High Voltage Fuses are typically used in distribution circuits and can be used for indoor or outdoor applications. They are available in four lengths and four different voltage ranges. Fuses supplied standardly with Striker Pins.

Example: 3 / 7.2KV High Voltage Fuses can be used on systems that operate on 3KV Voltage to 7.2KV Voltage. (3KV is the lower rated voltage and 7.2KV is the higher rated voltage.)

The High Voltage Fuses offered comply with IEC, DIN and VDE. Please consult Altech for 3 / 3.6KV, 17.5KV Fuses and also for High Voltage fuses which comply with BS 2692 and FSI 12-8 standards.

(IEC 282-1 / VDE 0670)



3 / 7.2KV

Ordering Information

192mm (7.56 in.) Length (L) Fuse

| Rated Current | Cat No. | Dim. | Std. Pk. |
|---------------|--------------|----------------|----------|
| 6A | 6HH7.2-192 | D | 1 |
| 10A | 10HH7.2-192 | D | 1 |
| 16A | 16HH7.2-192 | D | 1 |
| 20A | 20HH7.2-192 | D | 1 |
| 25A | 25HH7.2-192 | D | 1 |
| 30A | 30HH7.2-192 | D | 1 |
| 40A | 40HH7.2-192 | D | 1 |
| 50A | 50HH7.2-192 | D | 1 |
| 63A | 63HH7.2-192 | E | 1 |
| 80A | 80HH7.2-192 | E | 1 |
| 100A | 100HH7.2-192 | E ¹ | 1 |
| 125A | 125HH7.2-192 | F | 1 |
| 160A | 160HH7.2-192 | F | 1 |
| 200A | 200HH7.2-192 | F | 1 |
| 250A | 250HH7.2-192 | F | 1 |

292mm (11.50 in.) Length (L) Fuse

| | | | |
|------|--------------|---|---|
| 6A | 6HH7.2-292 | A | 1 |
| 10A | 10HH7.2-292 | A | 1 |
| 16A | 16HH7.2-292 | A | 1 |
| 20A | 20HH7.2-292 | A | 1 |
| 25A | 25HH7.2-292 | A | 1 |
| 30A | 30HH7.2-292 | A | 1 |
| 40A | 40HH7.2-292 | A | 1 |
| 50A | 50HH7.2-292 | A | 1 |
| 63A | 63HH7.2-292 | B | 1 |
| 80A | 80HH7.2-292 | B | 1 |
| 100A | 100HH7.2-292 | B | 1 |
| 125A | 125HH7.2-292 | C | 1 |
| 160A | 160HH7.2-292 | C | 1 |
| 200A | 200HH7.2-292 | C | 1 |
| 250A | 250HH7.2-292 | C | 1 |
| 315A | 315HH7.2-292 | C | 1 |
| 355A | 355HH7.2-292 | C | 1 |

442mm (17.40 in.) Length (L) Fuse

| | | | |
|------|--------------|---|---|
| 100A | 100HH7.2-442 | G | 1 |
| 125A | 125HH7.2-442 | G | 1 |
| 160A | 160HH7.2-442 | G | 1 |
| 200A | 200HH7.2-442 | G | 1 |
| 250A | 250HH7.2-442 | G | 1 |
| 315A | 315HH7.2-442 | G | 1 |
| 355A | 355HH7.2-442 | G | 1 |
| 400A | 400HH7.2-442 | G | 1 |
| 500A | 500HH7.2-442 | G | 1 |

537mm (21.14 in.) Length (L) Fuse

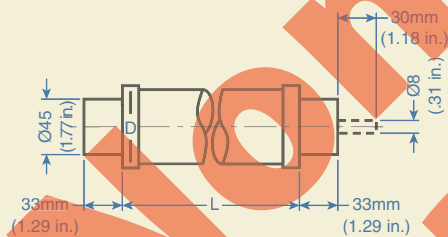

Approximate Dimensions for High Voltage Fuses mm (in.)*

| Fuse Dim. | Diameter (D) | Fuse Dim. | Diameter (D) |
|-----------|--------------|-----------|--------------|
| A | 53 (2.09) | F | 85 (3.35) |
| B | 67 (2.64) | G | 85 (3.35) |
| C | 85 (3.35) | H | 53 (2.09) |
| D | 53 (2.09) | I | 67 (2.64) |
| E | 67 (2.64) | J | 85 (3.35) |
| | | K | 53 (2.09) |

¹ Also available with a 85mm (3.35 in.) diameter.
* Dimension to DIN 43625



6 / 12KV



10 / 24KV

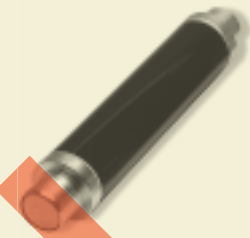

20 / 36KV

Rated Current **Cat No.** **Dim.** **Std. Pk.**

| | | | |
|------|-------------|---|---|
| 6A | 6HH12-292 | A | 1 |
| 10A | 10HH12-292 | A | 1 |
| 16A | 16HH12-292 | A | 1 |
| 20A | 20HH12-292 | A | 1 |
| 25A | 25HH12-292 | A | 1 |
| 30A | 30HH12-292 | A | 1 |
| 40A | 40HH12-292 | A | 1 |
| 50A | 50HH12-292 | A | 1 |
| 63A | 63HH12-292 | B | 1 |
| 80A | 80HH12-292 | B | 1 |
| 100A | 100HH12-292 | B | 1 |
| 125A | 125HH12-292 | C | 1 |
| 160A | 160HH12-292 | C | 1 |
| 200A | 200HH12-292 | C | 1 |

| | | | |
|------|-------------|---|---|
| 6A | 6HH12-442 | H | 1 |
| 10A | 10HH12-442 | H | 1 |
| 16A | 16HH12-442 | H | 1 |
| 20A | 20HH12-442 | H | 1 |
| 25A | 25HH12-442 | H | 1 |
| 30A | 30HH12-442 | H | 1 |
| 40A | 40HH12-442 | H | 1 |
| 50A | 50HH12-442 | H | 1 |
| 63A | 63HH12-442 | I | 1 |
| 80A | 80HH12-442 | I | 1 |
| 100A | 100HH12-442 | I | 1 |
| 125A | 125HH12-442 | G | 1 |
| 160A | 160HH12-442 | G | 1 |
| 200A | 200HH12-442 | G | 1 |
| 250A | 250HH12-442 | G | 1 |

| | | | |
|------|-------------|---|---|
| 100A | 100HH12-537 | J | 1 |
| 125A | 125HH12-537 | J | 1 |
| 160A | 160HH12-537 | J | 1 |
| 200A | 200HH12-537 | J | 1 |
| 250A | 250HH12-537 | J | 1 |
| 315A | 315HH12-537 | J | 1 |

Rated Current **Cat No.** **Dim.** **Std. Pk.**

| | | | |
|------|-------------|---|---|
| 6A | 6HH24-442 | H | 1 |
| 10A | 10HH24-442 | H | 1 |
| 16A | 16HH24-442 | H | 1 |
| 20A | 20HH24-442 | H | 1 |
| 25A | 25HH24-442 | H | 1 |
| 30A | 30HH24-442 | H | 1 |
| 40A | 40HH24-442 | H | 1 |
| 50A | 50HH24-442 | I | 1 |
| 63A | 63HH24-442 | I | 1 |
| 80A | 80HH24-442 | I | 1 |
| 100A | 100HH24-442 | G | 1 |
| 125A | 125HH24-442 | G | 1 |

| | | | |
|------|-------------|---|---|
| 6A | 6HH24-537 | K | 1 |
| 10A | 10HH24-537 | K | 1 |
| 16A | 16HH24-537 | K | 1 |
| 20A | 20HH24-537 | K | 1 |
| 25A | 25HH24-537 | K | 1 |
| 30A | 30HH24-537 | K | 1 |
| 40A | 40HH24-537 | K | 1 |
| 50A | 50HH24-537 | L | 1 |
| 63A | 63HH24-537 | L | 1 |
| 80A | 80HH24-537 | L | 1 |
| 100A | 100HH24-537 | J | 1 |
| 125A | 125HH24-537 | J | 1 |
| 160A | 160HH24-537 | J | 1 |
| 200A | 200HH24-537 | J | 1 |

Rated Current **Cat No.** **Dim.** **Std. Pk.**

| | | | |
|-----|------------|---|---|
| 6A | 6HH36-537 | K | 1 |
| 10A | 10HH36-537 | K | 1 |
| 16A | 16HH36-537 | K | 1 |
| 20A | 20HH36-537 | K | 1 |
| 25A | 25HH36-537 | K | 1 |
| 30A | 30HH36-537 | L | 1 |
| 40A | 40HH36-537 | L | 1 |
| 50A | 50HH36-537 | J | 1 |
| 63A | 63HH36-537 | J | 1 |

SIEMENS / ALTECH FUSE CROSS REFERENCE

Note: Not all crosses are 100% identical but all are sufficient substitutes for fit, form and function.

| Siemens No. | Altech No. | Siemens No. | Altech No. | Siemens No. | Altech No. | Siemens No. | Altech No. |
|-------------|-----------------|-------------|------------|-------------|-------------|-------------|--------------|
| 3NA1431-6 | 355NH3GL-6 | 3NA3003 | 10NH0GL | 3NA3807-6 | 20NH00GL-6 | 3NE1030-0 | 315NH2AR-6 |
| 3NA1432-6 | 400NH3GL-6 | 3NA3005 | 16NH0GL | 3NA3810-6 | 25NH00GL-6 | 3NE1031-0 | 355NH2AR-6 |
| 3NA1434-6 | 500NH3GL-6 | 3NA3007 | 20NH0GL | 3NA3812-6 | 32NH00GL-6 | 3NE1032-0 | 400NH2AR-6 |
| | | 3NA3010 | 25NH0GL | 3NA3814-6 | 35NH00GL-6 | | |
| 3NA2105 | 16NH1GL-ISO | 3NA3012 | 32NH0GL | 3NA3817-6 | 40NH00GL-6 | 3NE1813-0 | 16NH00GR-6 |
| 3NA2107 | 20NH1GL-ISO | 3NA3014 | 35NH0GL | 3NA3820-6 | 50NH00GL-6 | 3NE1814-0 | 20NH00GR-6 |
| 3NA2110 | 25NH1GL-ISO | 3NA3017 | 40NH0GL | | | 3NE1815-0 | 25NH00GR-6 |
| 3NA2114 | 35NH1GL-ISO | 3NA3020 | 50NH0GL | 3NA3822-6 | 63NH00GL-6 | 3NE1803-0 | 35NH00GR-6 |
| 3NA2117 | 40NH1GL-ISO | 3NA3022 | 63NH0GL | 3NA3824-6 | 80NH00GL-6 | 3NE1802-0 | 40NH00GR-6 |
| 3NA2120 | 50NH1GL-ISO | 3NA3024 | 80NH0GL | 3NA3830-6 | 100NH00GL-6 | 3NE1817-0 | 50NH00GR-6 |
| 3NA2122 | 63NH1GL-ISO | 3NA3030 | 100NH0GL | | | 3NE1818-0 | 63NH00GR-6 |
| 3NA2124 | 80NH1GL-ISO | 3NA3032 | 125NH0GL | 3NA3802 | 2NH00GL | 3NE1820-0 | 80NH00GR-6 |
| 3NA2130 | 100NH1GL-ISO | 3NA3036 | 160NH0GL | 3NA3804 | 4NH00GL | | |
| 3NA2132 | 125NH1GL-ISO | | | 3NA3801 | 6NH00GL | 3NE3221 | 100NH1BGR-1 |
| 3NA2136 | 160NH1GL-ISO | 3NA3120-6 | 50NH1GL-6 | 3NA3803 | 10NH00GL | 3NE3222 | 125NH1BGR-1 |
| 3NA2140 | 200NH1GL-ISO | 3NA3122-6 | 63NH1GL-6 | 3NA3805 | 16NH00GL | 3NE3224 | 160NH1BAR-1 |
| 3NA2142 | 224NH1GL-ISO | 3NA3124-6 | 80NH1GL-6 | 3NA3807 | 20NH00GL | 3NE3225 | 200NH1BAR-1 |
| 3NA2144 | 250NH1GL-ISO | 3NA3130-6 | 100NH1GL-6 | 3NA3810 | 25NH00GL | 3NE3227 | 250NH1BAR-1 |
| | | 3NA3132-6 | 125NH1GL-6 | 3NA3812 | 32NH00GL | | |
| 3NA2120-6 | 50NH1GL-6-ISO | 3NA3136-6 | 160NH1GL-6 | 3NA3814 | 35NH00GL | 3NE3230-0B | 315SB1F1-1 |
| 3NA2122-6 | 63NH1GL-6-ISO | 3NA3140-6 | 200NH1GL-6 | 3NA3817 | 40NH00GL | 3NE3231 | 350SB1F1-1 |
| 3NA2124-6 | 80NH1GL-6-ISO | | | 3NA3820 | 50NH00GL | 3NE3232-0B | 400SB1F1-1 |
| 3NA2130-6 | 100NH1GL-6-ISO | 3NA3105 | 16NH1GL | 3NA3822 | 63NH00GL | 3NE3233 | 450SB1F1-1 |
| 3NA2132-6 | 125NH1GL-6-ISO | 3NA3107 | 20NH1GL | 3NA3824 | 80NH00GL | | |
| 3NA2136-6 | 160NH1GL-6-ISO | 3NA3110 | 25NH1GL | 3NA3830 | 100NH00GL | 3NE3421 | 100NH3BAR-1 |
| 3NA2140-6 | 200NH1GL-6-ISO | 3NA3114 | 35NH1GL | 3NA3832 | 125NH00GL | 3NE3425 | 224NH3BAR-1 |
| | | 3NA3117 | 40NH1GL | 3NA3836 | 160NH00GL | 3NE3626 | 224NH3BAR-1 |
| 3NA2224-6 | 80NH2GL-6-ISO | 3NA3120 | 50NH1GL | | | 3NE3430 | 315NH3BAR-1 |
| 3NA2230-6 | 100NH2GL-6-ISO | 3NA3122 | 63NH1GL | 3NC 2423 | 150NH3BGR-6 | 3NE3431 | 350NH3BAR-1 |
| 3NA2232-6 | 125NH2GL-6-ISO | 3NA3124 | 80NH1GL | 3NC 2425 | 200NH3BGR-6 | 3NE3635 | 450NH3BAR-1 |
| 3NA2236-6 | 160NH2GL-6-ISO | 3NA3130 | 100NH1GL | 3NC 2427 | 250NH3BGR-6 | 3NE3434 | 500NH3BAR-1 |
| 3NA2240-6 | 200NH2GL-6-ISO | 3NA3132 | 125NH1GL | 3NC 2428 | 300NH3BGR-6 | | |
| | | 3NA3136 | 160NH1GL | 3NC 2431 | 350NH3BGR-6 | 3NE4101 | 32NH0GR-1 |
| 3NA2214 | 35NH2GL-ISO | 3NA3140 | 200NH1GL | 3NC 2432 | 400NH3BGR-6 | 3NE4102 | 40NH0GR-1 |
| 3NA2220 | 50NH2GL-ISO | 3NA3142 | 224NH1GL | | | 3NE4117 | 50NH0GR-1 |
| 3NA2222 | 63NH2GL-ISO | 3NA3144 | 250NH1GL | 3NC 8423 | 150NH3BGR-6 | 3NE4118 | 63NH0AR-1 |
| 3NA2224 | 80NH2GL-ISO | | | 3NC 8425 | 200NH3BGR-6 | 3NE4120 | 80NH0AR-1 |
| 3NA2230 | 100NH2GL-ISO | 3NA3214 | 35NH2GL | 3NC 8427 | 250NH3BGR-6 | 3NE4121 | 100NH0AR-1 |
| 3NA2232 | 125NH2GL-ISO | 3NA3220 | 50NH2GL | 3NC 8431 | 350NH3BGR-6 | 3NE4122 | 125NH0AR-1 |
| 3NA2236 | 160NH2GL-ISO | 3NA3222 | 63NH2GL | 3NC 8434 | 500NH3BGR-6 | 3NE4124 | 160NH0AR-1 |
| 3NA2240 | 200NH2GL-ISO | 3NA3224 | 80NH2GL | | | 3NE4126 | 160NH0AR-1 |
| 3NA2242 | 224NH2GL-ISO | 3NA3230 | 100NH2GL | 3ND1122 | 63NH1AM-6 | | |
| 3NA2244 | 250NH2GL-ISO | 3NA3232 | 125NH2GL | 3ND1124 | 80NH1AM-6 | 3NE7425 | 200NH3BAR-2 |
| 3NA2250 | 300NH2GL-ISO | 3NA3236 | 160NH2GL | 3ND1130 | 100NH1AM-6 | 3NE7427 | 250NH3BAR-2 |
| 3NA2252 | 315NH2GL-ISO | 3NA3240 | 200NH2GL | 3ND1132 | 125NH1AM-6 | 3NE7431 | 350NH3BAR-2 |
| 3NA2254 | 355NH2GL-ISO | 3NA3242 | 224NH2GL | 3ND1136 | 160NH1AM-6 | 3NE7432 | 400NH3BAR-2 |
| 3NA2260 | 400NH2GL-ISO | 3NA3244 | 250NH2GL | 3ND1140 | 200NH1AM-6 | 3NE7633 | 450NH3BAR-2 |
| | | 3NA3250 | 300NH2GL | 3ND1144 | 250NH1AM-6 | | |
| 3NA2802 | 2NH00GL-ISO | 3NA3252 | 315NH2GL | | | 3NE8015 | 25NH00GR-6 |
| 3NA2804 | 4NH00GL-ISO | 3NA3254 | 355NH2GL | 3ND1232 | 125NH2AM-6 | 3NE8003 | 35NH00GR-6 |
| 3NA2801 | 6NH00GL-ISO | 3NA3260 | 400NH2GL | 3ND1236 | 160NH2AM-6 | 3NE8017 | 50NH00GR-6 |
| 3NA2803 | 10NH00GL-ISO | | | 3ND1240 | 200NH2AM-6 | 3NE8018 | 63NH00GR-6 |
| 3NA2805 | 16NH00GL-ISO | 3NA3224-6 | 80NH2GL-6 | 3ND1244 | 250NH2AM-6 | 3NE8020 | 80NH00GR-6 |
| 3NA2807 | 20NH00GL-ISO | 3NA3230-6 | 100NH2GL-6 | 3ND1252 | 315NH2AM-6 | 3NE8021 | 100NH0GR-6 |
| 3NA2810 | 25NH00GL-ISO | 3NA3232-6 | 125NH2GL-6 | 3ND1254 | 355NH2AM-6 | 3NE8022 | 125NH00GR-6 |
| 3NA2812 | 32NH00GL-ISO | 3NA3236-6 | 160NH2GL-6 | 3ND1260 | 400NH2AM-6 | 3NE8024 | 160NH00AR-6 |
| 3NA2814 | 35NH00GL-ISO | 3NA3240-6 | 200NH2GL-6 | | | | |
| 3NA2817 | 40NH00GL-ISO | 3NA3244-6 | 250NH2GL-6 | 3ND1352 | 315NH3AM-6 | 3NE8701 | 32SM00CAR-L |
| 3NA2820 | 50NH00GL-ISO | 3NA3252-6 | 315NH2GL-6 | 3ND1354 | 355NH3AM-6 | 3NE8702 | 40SM00CAR-L |
| 3NA2822 | 63NH00GL-ISO | | | 3ND1460 | 400NH3AM-6 | 3NE8714 | 20SM00CAR-L |
| 3NA2824 | 80NH00GL-ISO | 3NA3354-6 | 355NH3GL-6 | 3ND1365 | 500NH3AM-6 | 3NE8715 | 25SM00CAR-L |
| 3NA2830 | 100NH00GL-ISO | 3NA3360-6 | 400NH3GL-6 | 3ND1372 | 630NH3AM-6 | 3NE8717 | 50SM00CAR-L |
| 3NA2832 | 125NH00GL-ISO | 3NA3365-6 | 500NH3GL-6 | | | 3NE8718 | 63SM00CAR-L |
| 3NA2836 | 160NH00GL-ISO | | | 3ND1803 | 10NH00AM-6 | 3NE8720 | 80SM00CAR-L |
| | | 3NA3344 | 250NH3GL | 3ND1805 | 16NH00AM-6 | 3NE8721 | 100SM00CAR-L |
| 3NA2802-6 | 2NH00GL-6-ISO | 3NA3350 | 300NH3GL | 3ND1807 | 20NH00AM-6 | 3NE8722 | 125SM00CAR-L |
| 3NA2804-6 | 4NH00GL-6-ISO | 3NA3352 | 315NH3GL | 3ND1810 | 25NH00AM-6 | 3NE8724 | 160SM00CAR-L |
| 3NA2801-6 | 6NH00GL-6-ISO | 3NA3354 | 355NH3GL | 3ND1812 | 32NH00AM-6 | 3NE8725 | 200SM00CAR-L |
| 3NA2803-6 | 10NH00GL-6-ISO | 3NA3360 | 400NH3GL | 3ND1814 | 35NH00AM-6 | 3NE8727 | 250SM00CAR-L |
| 3NA2805-6 | 16NH00GL-6-ISO | 3NA3365 | 500NH3GL | 3ND1817 | 40NH00AM-6 | 3NE8731 | 315SM00CAR-L |
| 3NA2807-6 | 20NH00GL-6-ISO | 3NA3372 | 630NH3GL | 3ND1820 | 50NH00AM-6 | | |
| 3NA2810-6 | 25NH00GL-6-ISO | | | 3ND1822 | 63NH00AM-6 | 3NH3030 | NHB00-1 |
| 3NA2812-6 | 32NH00GL-6-ISO | 3NA3665 | 500NH4GL | 3ND1824 | 80NH00AM-6 | 3NH3120 | NHB0-1 |
| 3NA2814-6 | 35NH00GL-6-ISO | 3NA3672 | 630NH4GL | 3ND1830 | 100NH00AM-6 | 3NH3230 | NHB1-1 |
| 3NA2817-6 | 40NH00GL-6-ISO | 3NA3675 | 800NH4GL | 3ND1832 | 125NH00AM-6 | 3NH3330 | NHB2-1 |
| 3NA2820-6 | 50NH00GL-6-ISO | 3NA3680 | 1000NH4GL | 3ND1836 | 160NH00AM-6 | 3NH3430 | NHB3-1 |
| 3NA2822-6 | 63NH00GL-6-ISO | 3NA3682 | 1250NH4GL | | | 3NH4030 | NHB00-3 |
| 3NA2824-6 | 80NH00GL-6-ISO | | | 3NE1021-0 | 100NH00GR-6 | 3NH4230 | NHB1-3 |
| 3NA2830-6 | 100NH00GL-6-ISO | 3NA3802-6 | 2NH00GL-6 | 3NE1022-0 | 125NH00GR-6 | 3NH7520 | NHB4A-1 |
| | | 3NA3804-6 | 4NH00GL-6 | | | | |
| 3NA3001 | 6NH0GL | 3NA3801-6 | 6NH00GL-6 | 3NE1024-0 | 160NH1AR-6 | | |
| 3NA3002 | 10NH0GL | 3NA3803-6 | 10NH00GL-6 | 3NE1025-0 | 200NH1AR-6 | | |
| | | 3NA3805-6 | 16NH00GL-6 | 3NE1027-0 | 250NH1AR-6 | | |

| Siemens No. | Altech No. | Siemens No. | Altech No. | Siemens No. | Altech No. | Siemens No. | Altech No. |
|-------------|-------------|-------------|-------------|-------------|------------|-------------|------------|
| 3NW6002-1 | 2C10x38GI | 3NW8203-1 | 10C22x58AM | 5SD601 | 2D33FB-7 | 5SH310 | D27AS02 |
| 3NW6004-1 | 4C10x38GI | 3NW8205-1 | 16C22x58AM | 5SD602 | 4D33FB-7 | 5SH311 | D27AS04 |
| 3NW6001-1 | 6C10x38GI | 3NW8207-1 | 20C22x58AM | 5SD603 | 6D33FB-7 | 5SH312 | D27AS06 |
| 3NW6008-1 | 8C10x38GI | 3NW8210-1 | 25C22x58AM | 5SD604 | 10D33FB-7 | 5SH313 | D27AS10 |
| 3NW6003-1 | 10C10x38GI | 3NW8212-1 | 32C22x58AM | 5SD605 | 16D33FB-7 | 5SH314 | D27AS16 |
| 3NW6006-1 | 12C10x38GI | 3NW8217-1 | 40C22x58AM | 5SD606 | 20D33FB-7 | 5SH315 | D27AS20 |
| 3NW6005-1 | 16C10x38GI | 3NW8220-1 | 50C22x58AM | 5SD607 | 25D33FB-7 | 5SH316 | D27AS25 |
| 3NW6007-1 | 20C10x38GI | 3NW8222-1 | 63C22x58AM | 5SD608 | 35D33FB-7 | | |
| 3NW6010-1 | 25C10x38GI | 3NW8224-1 | 80C22x58AM | 5SD610 | 50D33FB-7 | 5SH3703 | DAT |
| | | 3NW8230-1 | 100C22x58AM | 5SD611 | 63D33FB-7 | | |
| 3NW6104-1 | 4C14x51GI | | | | | 5SH4316 | NZ01C |
| 3NW6101-1 | 6C14x51GI | 3NX2023 | NHEP0 | 5SD8002 | 2D33SB-6 | 5SH4363 | NZ02C |
| 3NW6108-1 | 8C14x51GI | 3NX2030 | NHEP0 | 5SD8004 | 4D33SB-6 | 5SH4100 | NZ03C |
| 3NW6103-1 | 10C14x51GI | 3NX2024 | NHEP1 | 5SD8006 | 6D33SB-6 | | |
| 3NW6106-1 | 12C14x51GI | 3NX2025 | NHEP2 | 5SD8010 | 10D33SB-6 | 5SH5002 | NZ01AR02 |
| 3NW6105-1 | 16C14x51GI | 3NX2026 | NHEP3 | 5SD8016 | 16D33SB-6 | 5SH5004 | NZ01AR04 |
| 3NW6107-1 | 20C14x51GI | | | 5SD8016 | 20D33SB-6 | 5SH5006 | NZ01AR06 |
| 3NW6110-1 | 25C14x51GI | 3NX3105 | NHTC00 | 5SD8020 | 25D33SB-6 | 5SH5010 | NZ01AR10 |
| 3NW6112-1 | 32C14x51GI | | | 5SD8025 | 35D33SB-6 | 5SH5020 | NZ02AR20 |
| 3NW6117-1 | 40C14x51GI | 3NX1011 | NHHA | 5SD8035 | 50D33SB-6 | 5SH5025 | NZ02AR25 |
| 3NW6120-1 | 50C14x51GI | | | 5SD8050 | 63D33SB-6 | 5SH5035 | NZ02AR35 |
| | | 3NX1012 | NHSG | 5SD8063 | | 5SH5050 | NZ02AR50 |
| | | | | | | 5SH5080 | NZ03AR80 |
| 3NW6208-1 | 8C22x58GI | 5SA111 | 2D16FB | 5SE2002 | 2NZ01GL | 5SH5100 | NAT |
| 3NW6203-1 | 10C22x58GI | 5SA121 | 4D16FB | 5SE2004 | 4NZ01GL | | |
| 3NW6216-1 | 12C22x58GI | 5SA131 | 6D16FB | 5SE2006 | 6NZ01GL | | |
| 3NW6205-1 | 16C22x58GI | 5SA151 | 10D16FB | 5SE2010 | 10NZ01GL | 5SH5231 | NZ01BC |
| 3NW6207-1 | 20C22x58GI | 5SA161 | 16D16FB | 5SE2016 | 16NZ01GL | 5SH5233 | NZ02BC |
| 3NW6210-1 | 25C22x58GI | 5SA171 | 20D16FB | | | | NZ03BC |
| 3NW6212-1 | 32C22x58GI | 5SA181 | 25D16FB | 5SE2020 | 20NZ02GL | | |
| 3NW6217-1 | 40C22x58GI | | | 5SE2025 | 25NZ02GL | 5SH5232 | NZ01BC3 |
| 3NW6220-1 | 50C22x58GI | 5SA211 | 2D16SB | 5SE2035 | 35NZ02GL | 5SH5232 | NZ02BC3 |
| 3NW6222-1 | 63C22x58GI | 5SA221 | 4D16SB | 5SE2050 | 50NZ02GL | | |
| 3NW6224-1 | 80C22x58GI | 5SA231 | 6D16SB | 5SE2063 | 63NZ02GL | | |
| 3NW6230-1 | 100C22x58GI | 5SA251 | 10D16SB | | | | |
| | | 5SA261 | 16D16SB | 5SE2080 | 80NZ03GL | | |
| 3NW6302-1 | 2C8x32GI | 5SA271 | 20D16SB | 5SE2100 | 100NZ03GL | | |
| 3NW6304-1 | 4C8x32GI | 5SA281 | 25D16SB | | | | |
| 3NW6301-1 | 6C8x32GI | | | 5SE2202 | 2NZ01GL | | |
| 3NW6303-1 | 10C8x32GI | 5SB111 | 2D27FB | 5SE2204 | 4NZ01GL | | |
| 3NW6306-1 | 12C8x32GI | 5SB121 | 4D27FB | 5SE2206 | 6NZ01GL | | |
| 3NW6305-1 | 16C8x32GI | 5SB131 | 6D27FB | 5SE2210 | 10NZ01GL | | |
| 3NW6307-1 | 20C8x32GI | 5SB151 | 10D27FB | 5SE2216 | 16NZ01GL | | |
| | | 5SB161 | 16D27FB | 5SE2220 | 20NZ02GL | | |
| 3NW7010 | CB1038-1 | 5SB171 | 20D27FB | 5SE2225 | 25NZ02GL | | |
| 3NW7050 | CB1038-1N | 5SB181 | 25D27FB | 5SE2235 | 35NZ02GL | | |
| 3NW7020 | CB1038-2 | | | 5SE2250 | 50NZ02GL | | |
| 3NW7030 | CB1038-3 | 5SB211 | 2D27SB | 5SE2263 | 63NZ02GL | | |
| 3NW7060 | CB1038-3N | 5SB221 | 4D27SB | 5SE2280 | 80NZ03GL | | |
| 3NW7110 | CB1451-1 | 5SB231 | 6D27SB | 5SE2300 | 100NZ03GL | | |
| 3NW7150 | CB1451-1N | 5SB251 | 10D27SB | | | | |
| 3NW7120 | CB1451-2 | 5SB261 | 16D27SB | 5SF1012 | D16B | | |
| | | | | 5SF1005 | D27B | | |
| 3NW7130 | CB1451-3 | 5SB271 | 20D27SB | 5SF1215 | D33B | | |
| 3NW7160 | CB1451-3N | 5SB281 | 25D27SB | 5SF1242 | D33B | | |
| | | | | | | | |
| 3NW7210 | CB2258-1 | 5SB311 | 35D33FB | 5SF5081 | D27B3 | | |
| 3NW7250 | CB2258-1N | 5SB321 | 50D33FB | 5SF5241 | D33B3 | | |
| 3NW7220 | CB2258-2 | 5SB331 | 63D33FB | | | | |
| 3NW7230 | CB2258-3 | | | 5SG1582 | NZ01B | | |
| 3NW7260 | CB2258-3N | 5SB411 | 35D33SB | 5SG1672 | NZ02B | | |
| | | 5SB421 | 50D33SB | 5SG1682 | NZ02B | | |
| | | 5SB431 | 63D33SB | | | | |
| 3NW8011-1 | 1C10x38AM | | | 5SG1812 | NZ03B | | |
| 3NW8002-1 | 2C10x38AM | 5SC111 | 80D1.25FB | 5SG5672 | NZ02B3 | | |
| 3NW8004-1 | 4C10x38AM | 5SC121 | 100D1.25FB | | | | |
| 3NW8001-1 | 6C10x38AM | | | 5SG5572 | NZ01B3 | | |
| 3NW8008-1 | 8C10x38AM | 5SC211 | 80D1.25SB | 5SG5682 | NZ02B3 | | |
| 3NW8003-1 | 10C10x38AM | 5SC221 | 100D1.25SB | | | | |
| 3NW8005-1 | 16C10x38AM | | | 5SH111 | D16C | | |
| 3NW8007-1 | 20C10x38AM | 5SD420 | 16D27SC | 5SH112 | D27C | | |
| 3NW8010-1 | 25C10x38AM | 5SD430 | 20D27SC | 5SH113 | D33C | | |
| | | 5SD440 | 25D27SC | 5SH122 | D27C | | |
| | | 5SD480 | 30D27SC | 5SH123 | D33C | | |
| 3NW8102-1 | 2C14x51AM | | | 5SH124 | D1.25C | | |
| 3NW8104-1 | 4C14x51AM | | | | | | |
| 3NW8101-1 | 6C14x51AM | 5SD450 | 35D33SC | | | | |
| 3NW8108-1 | 8C14x51AM | 5SD460 | 50D33SC | 5SH2032 | D27BC | | |
| 3NW8103-1 | 10C14x51AM | 5SD470 | 63D33SC | 5SH2232 | D33BC | | |
| 3NW8105-1 | 16C14x51AM | | | | | | |
| 3NW8107-1 | 20C14x51AM | 5SD510 | 80D1.25SC | | | | |
| 3NW8110-1 | 25C14x51AM | 5SD520 | 100D1.25SC | | | | |
| 3NW8112-1 | 32C14x51AM | | | | | | |
| 3NW8117-1 | 40C14x51AM | | | | | | |
| 3NW8120-1 | 50C14x51AM | | | | | | |

Компания «Океан Электроники» предлагает заключение долгосрочных отношений при поставках импортных электронных компонентов на взаимовыгодных условиях!

Наши преимущества:

- Поставка оригинальных импортных электронных компонентов напрямую с производств Америки, Европы и Азии, а так же с крупнейших складов мира;
- Широкая линейка поставок активных и пассивных импортных электронных компонентов (более 30 млн. наименований);
- Поставка сложных, дефицитных, либо снятых с производства позиций;
- Оперативные сроки поставки под заказ (от 5 рабочих дней);
- Экспресс доставка в любую точку России;
- Помощь Конструкторского Отдела и консультации квалифицированных инженеров;
- Техническая поддержка проекта, помощь в подборе аналогов, поставка прототипов;
- Поставка электронных компонентов под контролем ВП;
- Система менеджмента качества сертифицирована по Международному стандарту ISO 9001;
- При необходимости вся продукция военного и аэрокосмического назначения проходит испытания и сертификацию в лаборатории (по согласованию с заказчиком);
- Поставка специализированных компонентов военного и аэрокосмического уровня качества (Xilinx, Altera, Analog Devices, Intersil, Interpoint, Microsemi, Actel, Aeroflex, Peregrine, VPT, Syfer, Eurofarad, Texas Instruments, MS Kennedy, Miteq, Cobham, E2V, MA-COM, Hittite, Mini-Circuits, General Dynamics и др.);

Компания «Океан Электроники» является официальным дистрибьютором и эксклюзивным представителем в России одного из крупнейших производителей разъемов военного и аэрокосмического назначения «JONHON», а так же официальным дистрибьютором и эксклюзивным представителем в России производителя высокотехнологичных и надежных решений для передачи СВЧ сигналов «FORSTAR».



JONHON

«JONHON» (основан в 1970 г.)

Разъемы специального, военного и аэрокосмического назначения:

(Применяются в военной, авиационной, аэрокосмической, морской, железнодорожной, горно- и нефтедобывающей отраслях промышленности)

«FORSTAR» (основан в 1998 г.)

ВЧ соединители, коаксиальные кабели,
кабельные сборки и микроволновые компоненты:

(Применяются в телекоммуникациях гражданского и специального назначения, в средствах связи, РЛС, а так же военной, авиационной и аэрокосмической отраслях промышленности).



Телефон: 8 (812) 309-75-97 (многоканальный)

Факс: 8 (812) 320-03-32

Электронная почта: ocean@oceanchips.ru

Web: <http://oceanchips.ru/>

Адрес: 198099, г. Санкт-Петербург, ул. Калинина, д. 2, корп. 4, лит. А