

500 mA, Fixed-Output, CMOS LDO with Shutdown

Features

- Very Low Dropout Voltage
- 500 mA Output Current
- High-Output Voltage Accuracy
- Standard or Custom Output Voltages
- Overcurrent and Overtemperature Protection
- $\overline{\text{SHDN}}$ Input for Active Power Management
- $\overline{\text{ERROR}}$ Output Can Be Used as a Low Battery Detector (SOIC only)

Applications

- Battery-Operated Systems
- Portable Computers
- Medical Instruments
- Instrumentation
- Cellular/GSM/PHS Phones
- Linear Post-Regulators for SMPS
- Pagers

Typical Application



Description

The TC1263 is a fixed-output, high-accuracy (typically $\pm 0.5\%$) CMOS low dropout regulator. Designed specifically for battery-operated systems, the TC1263's CMOS construction eliminates wasted ground current, significantly extending battery life. Total supply current is typically 80 μA at full load (20 to 60 times lower than in bipolar regulators).

TC1263 key features include ultra low noise operation, very low dropout voltage (typically 350 mV at full load) and fast response to step changes in load.

The TC1263 incorporates both overtemperature and overcurrent protection. The TC1263 is stable with an output capacitor of only 1 μF and has a maximum output current of 500 mA. It is available in 8-Pin SOIC, 5-Pin TO-220 and 5-Pin DDPAK packages.

Package Type



TC1263

1.0 ELECTRICAL CHARACTERISTICS

Absolute Maximum Ratings †

| | |
|---|--|
| Input Voltage | 6.5V |
| Output Voltage..... | (GND – 0.3V) to (V _{IN} + 0.3V) |
| Power Dissipation..... | Internally Limited (Note 7) |
| Voltage (max.) on Any Pin: (GND – 0.3V) to (V _{IN} + 0.3V) | |
| Operating Temperature Range.... | -40°C < T _J < +125°C |
| Storage Temperature..... | -65°C to +150°C |

† **Notice:** Stresses above those listed under "Maximum Ratings" may cause permanent damage to the device. This is a stress rating only and functional operation of the device at those or any other conditions above those indicated in the operation listings of this specification is not implied. Exposure to maximum rating conditions for extended periods may affect device reliability.

DC CHARACTERISTICS

| Electrical Specifications: Unless otherwise indicated, V _{IN} = V _R + 1.0V, (Note 1), I _L = 100 μA, C _L = 3.3 μF, SHDN > V _{IH} , T _A = +25°C. Boldface type specifications apply for junction temperatures of -40°C to +125°C. | | | | | | |
|--|-------------------------------------|-----------------------------|-----------------------|-----------------------------|--------|---|
| Parameters | Sym | Min | Typ | Max | Units | Conditions |
| Input Operating Voltage | V _{IN} | 2.7 | — | 6.0 | V | Note 2 |
| Maximum Output Current | I _{OUTMAX} | 500 | — | — | mA | |
| Output Voltage | V _{OUT} | V_R – 2.5% | V _R ± 0.5% | V_R + 2.5% | V | Note 1 |
| V _{OUT} Temperature Coefficient | ΔV _{OUT} /ΔT | — | 40 | — | ppm/°C | Note 3 |
| Line Regulation | ΔV _{OUT} /ΔV _{IN} | — | 0.05 | 0.35 | % | (V _R + 1V) ≤ V _{IN} ≤ 6V |
| Load Regulation (Note 4) | ΔV _{OUT} /V _{OUT} | -0.01 | 0.002 | +0.01 | %/mA | I _L = 0.1 mA to I _{OUTMAX} |
| Dropout Voltage (Note 5) | V _{IN} - V _{OUT} | — | 20 | 30 | mV | I _L = 100 μA |
| | | — | 60 | 130 | | I _L = 100 mA |
| | | — | 200 | 390 | | I _L = 300 mA |
| | | — | 350 | 650 | | I _L = 500 mA |
| Supply Current | I _{DD} | — | 80 | 130 | μA | SHDN = V _{IH} , I _L = 0 |
| Shutdown Supply Current | I _{SHDN} | — | 0.05 | 1 | μA | SHDN = 0V |
| Power Supply Rejection Ratio | PSRR | — | 64 | — | db | F ≤ 1 kHz |
| Output Short Circuit Current | I _{OUTSC} | — | 1200 | 1400 | mA | V _{OUT} = 0V |
| Thermal Regulation | ΔV _{OUT} /ΔP _D | — | 0.04 | — | V/W | Note 6 |
| Output Noise | eN | — | 260 | — | nV/√Hz | I _L = I _{OUTMAX} , F = 10 kHz |

- Note 1:** V_R is the regulator output voltage setting.
- Note 2:** The minimum V_{IN} has to justify the conditions: V_{IN} ≥ V_R + V_{DROPOUT} and V_{IN} ≥ 2.7V for I_L = 0.1 mA to I_{OUTMAX}.
- Note 3:**
- $$TCV_{OUT} = \frac{(V_{OUTMAX} - V_{OUTMIN}) - 10^6}{V_{OUT} \times \Delta T}$$
- Note 4:** Regulation is measured at a constant junction temperature using low duty-cycle pulse testing. Load regulation is tested over a load range from 0.1 mA to the maximum specified output current. Changes in output voltage due to heating effects are covered by the thermal regulation specification.
- Note 5:** Dropout voltage is defined as the input-to-output differential at which the output voltage drops 2% below its nominal value measured at a 1.0V differential.
- Note 6:** Thermal regulation is defined as the change in output voltage at a time T after a change in power dissipation is applied, excluding load or line regulation effects. Specifications are for a current pulse equal to I_{LMAX} at V_{IN} = 6V for T = 10 ms.
- Note 7:** The maximum allowable power dissipation is a function of ambient temperature, the maximum allowable junction temperature and the thermal resistance from junction-to-air (i.e., T_A, T_J, θ_{JA}). Exceeding the maximum allowable power dissipation causes the device to initiate thermal shutdown. Please see **Section 5.0 "Thermal Considerations"** for more details.

DC CHARACTERISTICS (CONTINUED)

Electrical Specifications: Unless otherwise indicated, $V_{IN} = V_R + 1.0V$, (**Note 1**), $I_L = 100 \mu A$, $C_L = 3.3 \mu F$, $\overline{SHDN} > V_{IH}$, $T_A = +25^\circ C$. **Boldface** type specifications apply for junction temperatures of $-40^\circ C$ to $+125^\circ C$.

| Parameters | Sym | Min | Typ | Max | Units | Conditions |
|---------------------------------|-----------|-----------|-------------------|------------|------------|----------------------------------|
| SHDN Input | | | | | | |
| SHDN Input High Threshold | V_{IH} | 45 | — | — | $\%V_{IN}$ | |
| SHDN Input Low Threshold | V_{IL} | — | — | 15 | $\%V_{IN}$ | |
| ERROR Output (SOIC Only) | | | | | | |
| Minimum Operating Voltage | V_{MIN} | 1.0 | — | — | V | |
| Output Logic Low Voltage | V_{OL} | — | — | 400 | mV | 1 mA Flows to \overline{ERROR} |
| ERROR Threshold Voltage | V_{TH} | — | $0.95 \times V_R$ | — | V | |
| ERROR Positive Hysteresis | V_{HYS} | — | 50 | — | mV | |

Note 1: V_R is the regulator output voltage setting.

2: The minimum V_{IN} has to justify the conditions: $V_{IN} \geq V_R + V_{DROPOUT}$ and $V_{IN} \geq 2.7V$ for $I_L = 0.1 \text{ mA}$ to I_{OUTMAX} .

3:

$$TCV_{OUT} = \frac{(V_{OUTMAX} - V_{OUTMIN}) - 10^6}{V_{OUT} \times \Delta T}$$

4: Regulation is measured at a constant junction temperature using low duty-cycle pulse testing. Load regulation is tested over a load range from 0.1 mA to the maximum specified output current. Changes in output voltage due to heating effects are covered by the thermal regulation specification.

5: Dropout voltage is defined as the input-to-output differential at which the output voltage drops 2% below its nominal value measured at a 1.0V differential.

6: Thermal regulation is defined as the change in output voltage at a time T after a change in power dissipation is applied, excluding load or line regulation effects. Specifications are for a current pulse equal to I_{LMAX} at $V_{IN} = 6V$ for $T = 10 \text{ ms}$.

7: The maximum allowable power dissipation is a function of ambient temperature, the maximum allowable junction temperature and the thermal resistance from junction-to-air (i.e., T_A , T_J , θ_{JA}). Exceeding the maximum allowable power dissipation causes the device to initiate thermal shutdown. Please see **Section 5.0 "Thermal Considerations"** for more details.

TEMPERATURE CHARACTERISTICS

Electrical Specifications: Unless otherwise indicated, $V_{IN} = V_R + 1.0V$, $I_L = 100 \mu A$, $C_L = 3.3 \mu F$, $\overline{SHDN} > V_{IH}$, $T_A = +25^\circ C$.

| Parameters | Sym | Min | Typ | Max | Units | Conditions |
|------------------------------------|---------------|-----|-----|------|--------------|---------------|
| Temperature Ranges | | | | | | |
| Specified Temperature Range | T_A | -40 | — | +125 | $^\circ C$ | Note 1 |
| Operating Temperature Range | T_J | -40 | — | +125 | $^\circ C$ | |
| Storage Temperature Range | T_A | -65 | — | +150 | $^\circ C$ | |
| Thermal Package Resistances | | | | | | |
| Thermal Resistance, 5L-DDPAK | θ_{JA} | — | 57 | — | $^\circ C/W$ | |
| Thermal Resistance, 5L-TO-220 | θ_{JA} | — | 71 | — | $^\circ C/W$ | |
| Thermal Resistance, 8L-SOIC | θ_{JA} | — | 163 | — | $^\circ C/W$ | |

Note 1: Operation in this range must not cause T_J to exceed Maximum Junction Temperature ($+125^\circ C$).

TC1263

2.0 TYPICAL PERFORMANCE CURVES

Note: The graphs and tables provided following this note are a statistical summary based on a limited number of samples and are provided for informational purposes only. The performance characteristics listed herein are not tested or guaranteed. In some graphs or tables, the data presented may be outside the specified operating range (e.g., outside specified power supply range) and therefore outside the warranted range.

Note: Unless otherwise indicated, $V_{IN} = V_R + 1.0V$, $I_L = 100 \mu A$, $C_L = 3.3 \mu F$, $\overline{SHDN} > V_{IH}$, $T_A = +25^\circ C$.

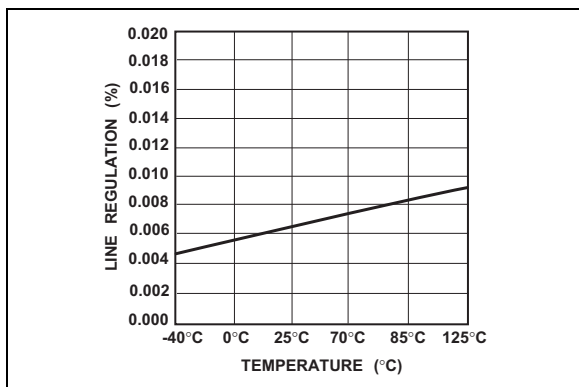

FIGURE 2-1: Line Regulation vs. Temperature.

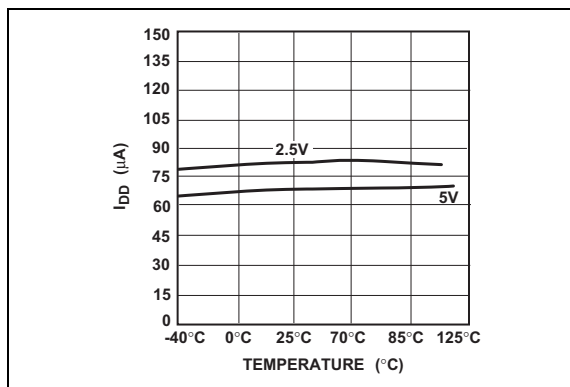

FIGURE 2-4: I_{DD} vs. Temperature.

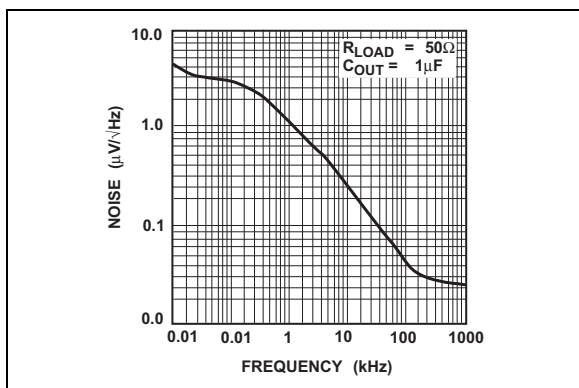

FIGURE 2-2: Output Noise vs. Frequency.

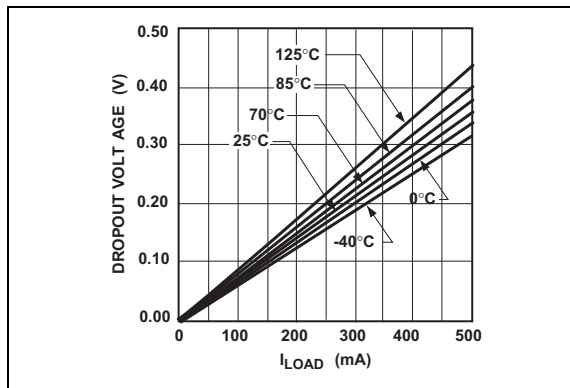

FIGURE 2-5: 2.5V Dropout Voltage vs. I_{LOAD} .



FIGURE 2-3: Load Regulation vs. Temperature.



FIGURE 2-6: 5.0V Dropout Voltage vs. I_{LOAD} .

Note: Unless otherwise indicated, $V_{IN} = V_R + 1.0V$, $I_L = 100 \mu A$, $C_L = 3.3 \mu F$, $\overline{SHDN} > V_{IH}$, $T_A = +25^\circ C$.



FIGURE 2-7: 2.5V V_{OUT} vs. Temperature.



FIGURE 2-8: 5.0V V_{OUT} vs. Temperature.

3.0 PIN DESCRIPTIONS

The descriptions of the pins are listed in Table 3-1.

TABLE 3-1: PIN FUNCTION TABLE

| Pin No. (8-Pin SOIC) | Pin No. (5-Pin DDPACK) (5-Pin TO-220) | Symbol | Description |
|-------------------------|---|--------------------|---|
| 1 | 5 | V_{OUT} | Regulated voltage output |
| 2 | 3 | GND | Ground terminal |
| 3 | — | NC | No connect |
| 4 | 1 | BYPASS | Reference bypass input |
| 5 | — | \overline{ERROR} | Out-of-Regulation Flag (open-drain output). |
| 6 | 2 | \overline{SHDN} | Shutdown control input |
| 7 | — | NC | No connect |
| 8 | 4 | V_{IN} | Unregulated supply input |

3.1 Regulated Output Voltage (V_{OUT})

V_{OUT} is a regulated voltage output.

3.2 Ground (GND)

Ground terminal.

3.3 Reference Bypass (BYPASS)

Reference bypass input. Connect a 470 pF to the BYPASS input to further reduce output noise.

3.4 Out-of-Regulation Flag (\overline{ERROR})

Out-of-Regulation Flag (open-drain output). \overline{ERROR} goes low when V_{OUT} is out-of-tolerance by approximately – 5%.

3.5 Shutdown Control (\overline{SHDN})

Shutdown control input. The regulator is fully enabled when a logic-high is applied to \overline{SHDN} . The regulator enters shutdown when a logic-low is applied to this input. During shutdown, output voltage falls to zero and supply current is reduced to 0.05 μ A (typical).

3.6 Unregulated Supply (V_{IN})

V_{IN} is an unregulated supply input.

4.0 DETAILED DESCRIPTION

The TC1263 is a precision, fixed-output LDO. Unlike bipolar regulators, the TC1263's supply current does not increase with load current. In addition, V_{OUT} remains stable and within regulation over the entire 0 mA to $I_{LOADMAX}$ load current range (an important consideration in RTC and CMOS RAM battery back-up applications).

Figure 4-1 shows a typical application circuit.



FIGURE 4-1: Typical Application Circuit.

4.1 Output Capacitor

A 1 µF (min.) capacitor from V_{OUT} to ground is required. The output capacitor should have an Effective Series Eesistance (ESR) greater than 0.1Ω and less than 5Ω. A 1 µF capacitor should be connected from V_{IN} to GND if there is either more than 10 inches of wire between the regulator and the AC filter capacitor or a battery is used as the power source. Aluminum electrolytic or tantalum capacitor types can be used. Since many aluminum electrolytic capacitors freeze at approximately -30°C, solid tantalums are recommended for applications operating below -25°C. When operating from sources other than batteries, supply-noise rejection and transient response can be improved by increasing the value of the input and output capacitors, and by employing passive filtering techniques.

4.2 ERROR Output

\overline{ERROR} is driven low whenever V_{OUT} falls out of regulation by more than -5% (typ.). This condition may be caused by low input voltage, output current limiting or thermal limiting. The \overline{ERROR} threshold is 5% below rated V_{OUT} , regardless of the programmed output voltage value (e.g., $\overline{ERROR} = V_{OL}$ at 4.75V (typ.) for a 5.0V regulator and 2.85V (typ.) for a 3.0V regulator). \overline{ERROR} output operation is shown in Figure 4-2.

Note that \overline{ERROR} is active when V_{OUT} is at or below V_{TH} , and inactive when V_{OUT} is above $V_{TH} + V_{HYS}$.

As shown in Figure 4-1, \overline{ERROR} can be used as a battery-low flag or as a processor \overline{RESET} signal (with the addition of timing capacitor C_3). $R_1 \times C_3$ should be chosen to maintain \overline{ERROR} below V_{IH} of the processor \overline{RESET} input for at least 200 ms to allow time for the system to stabilize. Pull-up resistor R_1 can be tied to V_{OUT} , V_{IN} or any other voltage less than $(V_{IN} + 0.3V)$.



FIGURE 4-2: \overline{ERROR} Output Operation.

TC1263

5.0 THERMAL CONSIDERATIONS

5.1 Thermal Shutdown

Integrated thermal protection circuitry shuts the regulator off when the die temperature exceeds 160°C. The regulator remains off until the die temperature drops to approximately 150°C.

5.2 Power Dissipation

The amount of power the regulator dissipates is primarily a function of input and output voltage and output current. The following equation is used to calculate worst-case actual power dissipation:

EQUATION 5-1:

$$P_D = (V_{INMAX} - V_{OUTMIN})I_{LOADMAX}$$

Where:

P_D = Worst-case actual power dissipation
 V_{INMAX} = Maximum voltage on V_{IN}
 V_{OUTMIN} = Minimum regulator output voltage
 $I_{LOADMAX}$ = Maximum output (load) current

The maximum allowable power dissipation (Equation 5-2) is a function of the maximum ambient temperature (T_{AMAX}), the maximum allowable die temperature (T_{JMAX}) and the thermal resistance from junction-to-air (θ_{JA}).

EQUATION 5-2:

$$P_{DMAX} = \frac{T_{JMAX} - T_{AMAX}}{\theta_{JA}}$$

Where:

P_D = Worst-case actual power dissipation
 V_{INMAX} = Maximum voltage on V_{IN}
 V_{OUTMIN} = Minimum regulator output voltage
 $I_{LOADMAX}$ = Maximum output (load) current

Table 5-1 and Table 5-2 show various values of θ_{JA} for the TC1263 package types.

TABLE 5-1: THERMAL RESISTANCE GUIDELINES FOR TC1263 IN 8-PIN SOIC PACKAGE

| Copper Area (Topside)* | Copper Area (Backside) | Board Area | Thermal Resistance (θ_{JA}) |
|------------------------|------------------------|------------|--------------------------------------|
| 2500 sq mm | 2500 sq mm | 2500 sq mm | 60°C/W |
| 1000 sq mm | 2500 sq mm | 2500 sq mm | 60°C/W |
| 225 sq mm | 2500 sq mm | 2500 sq mm | 68°C/W |
| 100 sq mm | 2500 sq mm | 2500 sq mm | 74°C/W |

* Pin 2 is ground. Device is mounted on top-side.

TABLE 5-2: THERMAL RESISTANCE GUIDELINES FOR TC1263 IN 5-PIN DDPAK/TO-220 PACKAGE

| Copper Area (Topside)* | Copper Area (Backside) | Board Area | Thermal Resistance (θ_{JA}) |
|------------------------|------------------------|------------|--------------------------------------|
| 2500 sq mm | 2500 sq mm | 2500 sq mm | 25°C/W |
| 1000 sq mm | 2500 sq mm | 2500 sq mm | 27°C/W |
| 125 sq mm | 2500 sq mm | 2500 sq mm | 35°C/W |

* Tab of device attached to top-side copper

Equation 5-1 can be used in conjunction with Equation 5-2 to ensure regulator thermal operation is within limits. For example:

Given:

$$\begin{aligned} V_{INMAX} &= 3.3V \pm 10\% \\ V_{OUTMIN} &= 2.7V \pm 0.5\% \\ I_{LOADMAX} &= 275 \text{ mA} \\ T_{JMAX} &= 125^\circ\text{C} \\ T_{AMAX} &= 95^\circ\text{C} \\ \theta_{JA} &= 60^\circ \text{ C/W (SOIC)} \end{aligned}$$

Find:

- Actual power dissipation
- Maximum allowable dissipation

Actual power dissipation:

$$\begin{aligned} P_D &\approx (V_{INMAX} - V_{OUTMIN})I_{LOADMAX} \\ P_D &= (3.3 \times 1.1) - (2.7 \times .995)275 \times 10^{-3} \\ P_D &= 260 \text{ mW} \end{aligned}$$

Maximum allowable power dissipation:

$$\begin{aligned} P_{DMAX} &= \frac{T_{JMAX} - T_{AMAX}}{\theta_{JA}} \\ P_{DMAX} &= \frac{(125 - 95)}{60} \\ P_{DMAX} &= 500 \text{ mW} \end{aligned}$$

In this example, the TC1263 dissipates a maximum of 260 mW below the allowable limit of 500 mW. In a similar manner, Equation 5-1 and Equation 5-2 can be used to calculate maximum current and/or input voltage limits. For example, the maximum allowable V_{IN} is found by substituting the maximum allowable power dissipation of 500 mW into Equation 5-1, from which $V_{INMAX} = 4.6V$.

6.0 PACKAGING INFORMATION

6.1 Package Marking Information

5-Lead DDPAK

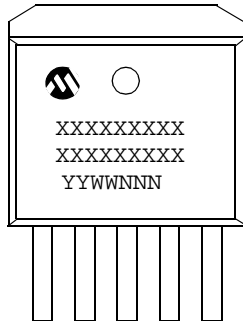

Example:



5-Lead TO-220

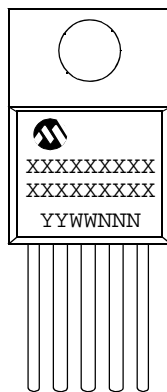

Example:



8-Lead SOIC (150 mil)

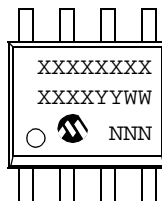

Example:



| | | |
|----------------|--------|--|
| Legend: | XX...X | Customer-specific information |
| | Y | Year code (last digit of calendar year) |
| | YY | Year code (last 2 digits of calendar year) |
| | WW | Week code (week of January 1 is week '01') |
| | NNN | Alphanumeric traceability code |
| | (e3) | Pb-free JEDEC designator for Matte Tin (Sn) |
| | * | This package is Pb-free. The Pb-free JEDEC designator (e3) can be found on the outer packaging for this package. |

Note: In the event the full Microchip part number cannot be marked on one line, it will be carried over to the next line, thus limiting the number of available characters for customer-specific information.

TC1263

5-Lead Plastic (ET) (DDPAK)

Note: For the most current package drawings, please see the Microchip Packaging Specification located at <http://www.microchip.com/packaging>



| Units | | INCHES* | | | MILLIMETERS | | |
|-----------------------|--------|----------|------|------|-------------|-------|-------|
| Dimension Limits | | MIN | NOM | MAX | MIN | NOM | MAX |
| Number of Pins | | 5 | | | 5 | | |
| Pitch | e | .067 BSC | | | 1.70 BSC | | |
| Overall Height | A | .170 | .177 | .183 | 4.32 | 4.50 | 4.65 |
| Standoff § | A1 | .000 | .005 | .010 | 0.00 | 0.13 | 0.25 |
| Overall Width | E | .385 | .398 | .410 | 9.78 | 10.11 | 10.41 |
| Exposed Pad Width | E1 | .256 REF | | | 6.50 REF | | |
| Molded Package Length | D | .330 | .350 | .370 | 8.38 | 8.89 | 9.40 |
| Overall Length | D1 | .549 | .577 | .605 | 13.94 | 14.66 | 15.37 |
| Exposed Pad Length | D2 | .303 REF | | | 7.75 REF | | |
| Lead Thickness | c | .014 | .020 | .026 | 0.36 | 0.51 | 0.66 |
| Pad Thickness | c2 | .045 | -- | .055 | 1.14 | -- | 1.40 |
| Lead Width | b | .026 | .032 | .037 | 0.66 | 0.81 | 0.94 |
| Foot Length | L | .068 | .089 | .110 | 1.73 | 2.26 | 2.79 |
| Pad Length | L3 | .045 | -- | .067 | 1.14 | -- | 1.70 |
| Lead Angle | theta | -- | -- | 8° | -- | -- | 8° |
| Mold Draft Angle | theta1 | 3° | -- | 7° | 3° | -- | 7° |

*Controlling Parameter

§ Significant Characteristic

Notes:

Dimensions D and E do not include mold flash or protrusions. Mold flash or protrusions shall not exceed .010" (0.254mm) per side.

JEDEC equivalent: TO-252

Drawing No. C04-012

5-Lead Plastic Transistor Outline (AT) (TO-220)

Note: For the most current package drawings, please see the Microchip Packaging Specification located at <http://www.microchip.com/packageing>

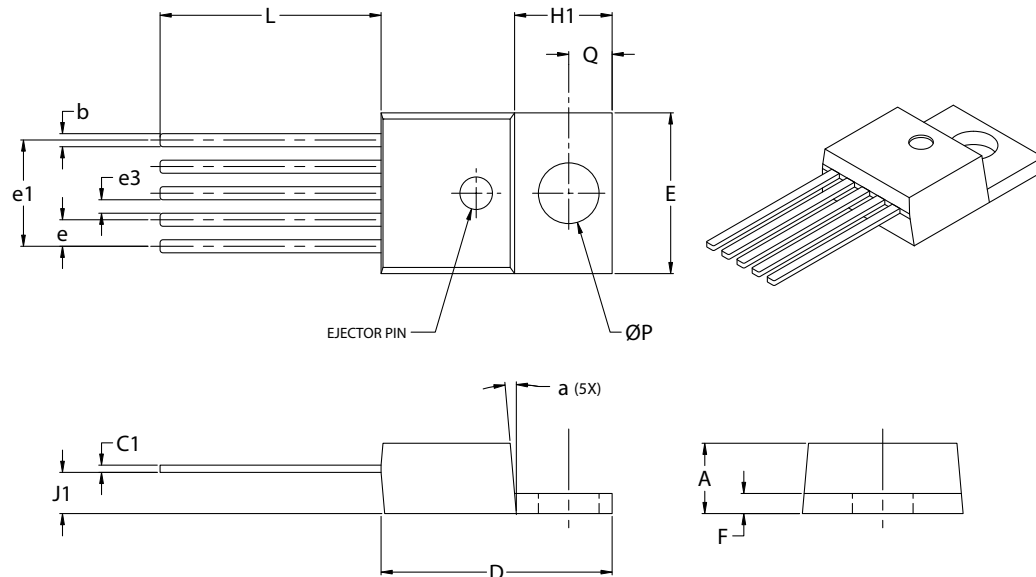

| Dimension Limits | Units | INCHES* | | MILLIMETERS | |
|------------------------|-------|---------|------|-------------|-------|
| | | MIN | MAX | MIN | MAX |
| Lead Pitch | e | .060 | .072 | 1.52 | 1.83 |
| Overall Lead Centers | e1 | .263 | .273 | 6.68 | 6.93 |
| Space Between Leads | e3 | .030 | .040 | 0.76 | 1.02 |
| Overall Height | A | .160 | .190 | 4.06 | 4.83 |
| Overall Width | E | .385 | .415 | 9.78 | 10.54 |
| Overall Length | D | .560 | .590 | 14.22 | 14.99 |
| Flag Length | H1 | .234 | .258 | 5.94 | 6.55 |
| Flag Thickness | F | .045 | .055 | 1.14 | 1.40 |
| Through Hole Center | Q | .103 | .113 | 2.62 | 2.87 |
| Through Hole Diameter | P | .146 | .156 | 3.71 | 3.96 |
| Lead Length | L | .540 | .560 | 13.72 | 14.22 |
| Base to Bottom of Lead | J1 | .090 | .115 | 2.29 | 2.92 |
| Lead Thickness | C1 | .014 | .022 | 0.36 | 0.56 |
| Lead Width | b | .025 | .040 | 0.64 | 1.02 |
| Mold Draft Angle | a | 3° | 7° | 3° | 7° |

*Controlling Parameter

Notes:

Dimensions D and E1 do not include mold flash or protrusions. Mold flash or protrusions shall not exceed .010" (0.254mm) per side.

JEDEC equivalent: TO-220

Drawing No. C04-036

TC1263

8-Lead Plastic Small Outline (SN) – Narrow, 150 mil Body (SOIC)

Note: For the most current package drawings, please see the Microchip Packaging Specification located at <http://www.microchip.com/packaging>



| Dimension Limits | Units | INCHES* | | | MILLIMETERS | | |
|--------------------------|-------|---------|------|------|-------------|------|------|
| | | MIN | NOM | MAX | MIN | NOM | MAX |
| Number of Pins | n | 8 | | | 8 | | |
| Pitch | p | | .050 | | | 1.27 | |
| Overall Height | A | .053 | .061 | .069 | 1.35 | 1.55 | 1.75 |
| Molded Package Thickness | A2 | .052 | .056 | .061 | 1.32 | 1.42 | 1.55 |
| Standoff § | A1 | .004 | .007 | .010 | 0.10 | 0.18 | 0.25 |
| Overall Width | E | .228 | .237 | .244 | 5.79 | 6.02 | 6.20 |
| Molded Package Width | E1 | .146 | .154 | .157 | 3.71 | 3.91 | 3.99 |
| Overall Length | D | .189 | .193 | .197 | 4.80 | 4.90 | 5.00 |
| Chamfer Distance | h | .010 | .015 | .020 | 0.25 | 0.38 | 0.51 |
| Foot Length | L | .019 | .025 | .030 | 0.48 | 0.62 | 0.76 |
| Foot Angle | φ | 0 | 4 | 8 | 0 | 4 | 8 |
| Lead Thickness | c | .008 | .009 | .010 | 0.20 | 0.23 | 0.25 |
| Lead Width | B | .013 | .017 | .020 | 0.33 | 0.42 | 0.51 |
| Mold Draft Angle Top | α | 0 | 12 | 15 | 0 | 12 | 15 |
| Mold Draft Angle Bottom | β | 0 | 12 | 15 | 0 | 12 | 15 |

* Controlling Parameter
 § Significant Characteristic

Notes:
 Dimensions D and E1 do not include mold flash or protrusions. Mold flash or protrusions shall not exceed .010" (0.254mm) per side.
 JEDEC Equivalent: MS-012
 Drawing No. C04-057

APPENDIX A: REVISION HISTORY

Revision D (November 2012)

Added a note to each package outline drawing.

Revision C (January 2005)

The following is the list of modifications:

1. Changes to DC Characteristics table
2. Added Appendix A: Revision History.

Revision B (May 2002)

No information for this revision.

Revision A (March 2002)

Original data sheet release.

TC1263

NOTES:

PRODUCT IDENTIFICATION SYSTEM

To order or obtain information, e.g., on pricing or delivery, refer to the factory or the listed sales office.

| <u>PART NO.</u> | <u>X.X</u> | <u>X</u> | <u>XX</u> | <u>XX</u> | Examples: |
|--------------------|--|-------------------|-----------|---------------|---|
| Device | Voltage Option | Temperature Range | Package | Tape and Reel | |
| Device | TC1263 Fixed Output CMOS LDO with Shutdown | | | | a) TC1263-2.5VAT 2.5V LDO, TO-220-5 pkg. |
| Voltage Option:* | 2.5 = 2.5V | | | | b) TC1263-2.8VAT 2.8V LDO, TO-220-5 pkg. |
| | 2.8 = 2.8V | | | | c) TC1263-3.0VAT 3.0V LDO, TO-220-5 pkg. |
| | 3.0 = 3.0V | | | | d) TC1263-3.3VAT 3.3V LDO, TO-220-5 pkg. |
| | 3.3 = 3.3V | | | | e) TC1263-5.0VAT 5.0V LDO, TO-220-5 pkg. |
| | 5.0 = 5.0V | | | | a) TC1263-2.5VETTR 1.8V LDO, DDPAK-5 pkg., Tape and Reel |
| | * Other output voltages are available. Please contact your local Microchip sales office for details. | | | | b) TC1263-2.8VETTR 2.5V LDO, DDPAK-5 pkg., Tape and Reel |
| Temperature Range: | V = -40°C to +125°C | | | | c) TC1263-3.0VETTR 3.0V LDO, DDPAK-5 pkg., Tape and Reel |
| Package | AT = Plastic (TO-220), 5-Lead | | | | d) TC1263-3.3VETTR 3.3V LDO, DDPAK-5 pkg., Tape and Reel |
| | ET = Plastic Transistor Outline (DDPAK), 5-Lead | | | | a) TC1263-2.5VOA 1.8V LDO, SOIC-8 pkg. |
| | ETTR = Plastic Transistor Outline (DDPAK), 5-Lead, Tape and Reel | | | | b) TC1263-2.5VOATR 1.8V LDO, SOIC-8 pkg., Tape and Reel |
| | OA = Plastic SOIC, (150 mil Body), 8-lead | | | | c) TC1263-2.8VOA 2.5V LDO, SOIC-8 pkg. |
| | OATR = Plastic SOIC, (150 mil Body), 8-lead, Tape and Reel | | | | d) TC1263-2.8VOATR 2.5V LDO, SOIC-8 pkg., Tape and Reel |
| | | | | | e) TC1263-3.0VOA 3.0V LDO, SOIC-8 pkg. |
| | | | | | f) TC1263-3.0VOATR 3.0V LDO, SOIC-8 pkg., Tape and Reel |
| | | | | | g) TC1263-3.3VOA 3.3V LDO, SOIC-8 pkg. |
| | | | | | h) TC1263-3.3VOATR 3.3V LDO, SOIC-8 pkg., Tape and Reel |
| | | | | | i) TC1263-5.0VOA 5.0V LDO, SOIC-8 pkg. |

TC1263

NOTES:

Note the following details of the code protection feature on Microchip devices:

- Microchip products meet the specification contained in their particular Microchip Data Sheet.
- Microchip believes that its family of products is one of the most secure families of its kind on the market today, when used in the intended manner and under normal conditions.
- There are dishonest and possibly illegal methods used to breach the code protection feature. All of these methods, to our knowledge, require using the Microchip products in a manner outside the operating specifications contained in Microchip's Data Sheets. Most likely, the person doing so is engaged in theft of intellectual property.
- Microchip is willing to work with the customer who is concerned about the integrity of their code.
- Neither Microchip nor any other semiconductor manufacturer can guarantee the security of their code. Code protection does not mean that we are guaranteeing the product as “unbreakable.”

Code protection is constantly evolving. We at Microchip are committed to continuously improving the code protection features of our products. Attempts to break Microchip's code protection feature may be a violation of the Digital Millennium Copyright Act. If such acts allow unauthorized access to your software or other copyrighted work, you may have a right to sue for relief under that Act.

Information contained in this publication regarding device applications and the like is provided only for your convenience and may be superseded by updates. It is your responsibility to ensure that your application meets with your specifications. MICROCHIP MAKES NO REPRESENTATIONS OR WARRANTIES OF ANY KIND WHETHER EXPRESS OR IMPLIED, WRITTEN OR ORAL, STATUTORY OR OTHERWISE, RELATED TO THE INFORMATION, INCLUDING BUT NOT LIMITED TO ITS CONDITION, QUALITY, PERFORMANCE, MERCHANTABILITY OR FITNESS FOR PURPOSE. Microchip disclaims all liability arising from this information and its use. Use of Microchip devices in life support and/or safety applications is entirely at the buyer's risk, and the buyer agrees to defend, indemnify and hold harmless Microchip from any and all damages, claims, suits, or expenses resulting from such use. No licenses are conveyed, implicitly or otherwise, under any Microchip intellectual property rights.

Trademarks

The Microchip name and logo, the Microchip logo, dsPIC, FlashFlex, KEELOQ, KEELOQ logo, MPLAB, PIC, PICmicro, PICSTART, PIC³² logo, rPIC, SST, SST Logo, SuperFlash and UNI/O are registered trademarks of Microchip Technology Incorporated in the U.S.A. and other countries.

FilterLab, Hampshire, HI-TECH C, Linear Active Thermistor, MTP, SEEVAL and The Embedded Control Solutions Company are registered trademarks of Microchip Technology Incorporated in the U.S.A.

Silicon Storage Technology is a registered trademark of Microchip Technology Inc. in other countries.

Analog-for-the-Digital Age, Application Maestro, BodyCom, chipKIT, chipKIT logo, CodeGuard, dsPICDEM, dsPICDEM.net, dsPICworks, dsSPEAK, ECAN, ECONOMONITOR, FanSense, HI-TIDE, In-Circuit Serial Programming, ICSP, Mindi, MiWi, MPASM, MPF, MPLAB Certified logo, MPLIB, MPLINK, mTouch, Omniclient Code Generation, PICC, PICC-18, PICDEM, PICDEM.net, PICkit, PICtail, REAL ICE, rLAB, Select Mode, SQI, Serial Quad I/O, Total Endurance, TSHARC, UniWinDriver, WiperLock, ZENA and Z-Scale are trademarks of Microchip Technology Incorporated in the U.S.A. and other countries.

SQTP is a service mark of Microchip Technology Incorporated in the U.S.A.

GestIC and ULPP are registered trademarks of Microchip Technology Germany II GmbH & Co. & KG, a subsidiary of Microchip Technology Inc., in other countries.

All other trademarks mentioned herein are property of their respective companies.

© 2002-2012, Microchip Technology Incorporated, Printed in the U.S.A., All Rights Reserved.

 Printed on recycled paper.

ISBN: 9781620767795

QUALITY MANAGEMENT SYSTEM
CERTIFIED BY DNV
== ISO/TS 16949 ==

Microchip received ISO/TS-16949:2009 certification for its worldwide headquarters, design and wafer fabrication facilities in Chandler and Tempe, Arizona; Gresham, Oregon and design centers in California and India. The Company's quality system processes and procedures are for its PIC[®] MCUs and dsPIC[®] DSCs, KEELOQ[®] code hopping devices, Serial EEPROMs, microperipherals, nonvolatile memory and analog products. In addition, Microchip's quality system for the design and manufacture of development systems is ISO 9001:2000 certified.



MICROCHIP

Worldwide Sales and Service

AMERICAS

Corporate Office
2355 West Chandler Blvd.
Chandler, AZ 85224-6199
Tel: 480-792-7200
Fax: 480-792-7277
Technical Support:
<http://www.microchip.com/support>
Web Address:
www.microchip.com

Atlanta
Duluth, GA
Tel: 678-957-9614
Fax: 678-957-1455

Boston
Westborough, MA
Tel: 774-760-0087
Fax: 774-760-0088

Chicago
Itasca, IL
Tel: 630-285-0071
Fax: 630-285-0075

Cleveland
Independence, OH
Tel: 216-447-0464
Fax: 216-447-0643

Dallas
Addison, TX
Tel: 972-818-7423
Fax: 972-818-2924

Detroit
Farmington Hills, MI
Tel: 248-538-2250
Fax: 248-538-2260

Indianapolis
Noblesville, IN
Tel: 317-773-8323
Fax: 317-773-5453

Los Angeles
Mission Viejo, CA
Tel: 949-462-9523
Fax: 949-462-9608

Santa Clara
Santa Clara, CA
Tel: 408-961-6444
Fax: 408-961-6445

Toronto
Mississauga, Ontario,
Canada
Tel: 905-673-0699
Fax: 905-673-6509

ASIA/PACIFIC

Asia Pacific Office
Suites 3707-14, 37th Floor
Tower 6, The Gateway
Harbour City, Kowloon
Hong Kong
Tel: 852-2401-1200
Fax: 852-2401-3431

Australia - Sydney
Tel: 61-2-9868-6733
Fax: 61-2-9868-6755

China - Beijing
Tel: 86-10-8569-7000
Fax: 86-10-8528-2104

China - Chengdu
Tel: 86-28-8665-5511
Fax: 86-28-8665-7889

China - Chongqing
Tel: 86-23-8980-9588
Fax: 86-23-8980-9500

China - Hangzhou
Tel: 86-571-2819-3187
Fax: 86-571-2819-3189

China - Hong Kong SAR
Tel: 852-2943-5100
Fax: 852-2401-3431

China - Nanjing
Tel: 86-25-8473-2460
Fax: 86-25-8473-2470

China - Qingdao
Tel: 86-532-8502-7355
Fax: 86-532-8502-7205

China - Shanghai
Tel: 86-21-5407-5533
Fax: 86-21-5407-5066

China - Shenyang
Tel: 86-24-2334-2829
Fax: 86-24-2334-2393

China - Shenzhen
Tel: 86-755-8864-2200
Fax: 86-755-8203-1760

China - Wuhan
Tel: 86-27-5980-5300
Fax: 86-27-5980-5118

China - Xian
Tel: 86-29-8833-7252
Fax: 86-29-8833-7256

China - Xiamen
Tel: 86-592-2388138
Fax: 86-592-2388130

China - Zhuhai
Tel: 86-756-3210040
Fax: 86-756-3210049

ASIA/PACIFIC

India - Bangalore
Tel: 91-80-3090-4444
Fax: 91-80-3090-4123

India - New Delhi
Tel: 91-11-4160-8631
Fax: 91-11-4160-8632

India - Pune
Tel: 91-20-2566-1512
Fax: 91-20-2566-1513

Japan - Osaka
Tel: 81-66-152-7160
Fax: 81-66-152-9310

Japan - Yokohama
Tel: 81-45-471-6166
Fax: 81-45-471-6122

Korea - Daegu
Tel: 82-53-744-4301
Fax: 82-53-744-4302

Korea - Seoul
Tel: 82-2-554-7200
Fax: 82-2-558-5932 or
82-2-558-5934

Malaysia - Kuala Lumpur
Tel: 60-3-6201-9857
Fax: 60-3-6201-9859

Malaysia - Penang
Tel: 60-4-227-8870
Fax: 60-4-227-4068

Philippines - Manila
Tel: 63-2-634-9065
Fax: 63-2-634-9069

Singapore
Tel: 65-6334-8870
Fax: 65-6334-8850

Taiwan - Hsin Chu
Tel: 886-3-5778-366
Fax: 886-3-5770-955

Taiwan - Kaohsiung
Tel: 886-7-213-7828
Fax: 886-7-330-9305

Taiwan - Taipei
Tel: 886-2-2508-8600
Fax: 886-2-2508-0102

Thailand - Bangkok
Tel: 66-2-694-1351
Fax: 66-2-694-1350

EUROPE

Austria - Wels
Tel: 43-7242-2244-39
Fax: 43-7242-2244-393

Denmark - Copenhagen
Tel: 45-4450-2828
Fax: 45-4485-2829

France - Paris
Tel: 33-1-69-53-63-20
Fax: 33-1-69-30-90-79

Germany - Munich
Tel: 49-89-627-144-0
Fax: 49-89-627-144-44

Italy - Milan
Tel: 39-0331-742611
Fax: 39-0331-466781

Netherlands - Drunen
Tel: 31-416-690399
Fax: 31-416-690340

Spain - Madrid
Tel: 34-91-708-08-90
Fax: 34-91-708-08-91

UK - Wokingham
Tel: 44-118-921-5869
Fax: 44-118-921-5820

11/27/12

Компания «Океан Электроники» предлагает заключение долгосрочных отношений при поставках импортных электронных компонентов на взаимовыгодных условиях!

Наши преимущества:

- Поставка оригинальных импортных электронных компонентов напрямую с производств Америки, Европы и Азии, а так же с крупнейших складов мира;
- Широкая линейка поставок активных и пассивных импортных электронных компонентов (более 30 млн. наименований);
- Поставка сложных, дефицитных, либо снятых с производства позиций;
- Оперативные сроки поставки под заказ (от 5 рабочих дней);
- Экспресс доставка в любую точку России;
- Помощь Конструкторского Отдела и консультации квалифицированных инженеров;
- Техническая поддержка проекта, помощь в подборе аналогов, поставка прототипов;
- Поставка электронных компонентов под контролем ВП;
- Система менеджмента качества сертифицирована по Международному стандарту ISO 9001;
- При необходимости вся продукция военного и аэрокосмического назначения проходит испытания и сертификацию в лаборатории (по согласованию с заказчиком);
- Поставка специализированных компонентов военного и аэрокосмического уровня качества (Xilinx, Altera, Analog Devices, Intersil, Interpoint, Microsemi, Actel, Aeroflex, Peregrine, VPT, Syfer, Eurofarad, Texas Instruments, MS Kennedy, Miteq, Cobham, E2V, MA-COM, Hittite, Mini-Circuits, General Dynamics и др.);

Компания «Океан Электроники» является официальным дистрибьютором и эксклюзивным представителем в России одного из крупнейших производителей разъемов военного и аэрокосмического назначения «JONHON», а так же официальным дистрибьютором и эксклюзивным представителем в России производителя высокотехнологичных и надежных решений для передачи СВЧ сигналов «FORSTAR».



JONHON

«JONHON» (основан в 1970 г.)

Разъемы специального, военного и аэрокосмического назначения:

(Применяются в военной, авиационной, аэрокосмической, морской, железнодорожной, горно- и нефтедобывающей отраслях промышленности)

«FORSTAR» (основан в 1998 г.)

ВЧ соединители, коаксиальные кабели,
кабельные сборки и микроволновые компоненты:

(Применяются в телекоммуникациях гражданского и специального назначения, в средствах связи, РЛС, а так же военной, авиационной и аэрокосмической отраслях промышленности).



Телефон: 8 (812) 309-75-97 (многоканальный)

Факс: 8 (812) 320-03-32

Электронная почта: ocean@oceanchips.ru

Web: <http://oceanchips.ru/>

Адрес: 198099, г. Санкт-Петербург, ул. Калинина, д. 2, корп. 4, лит. А