

Evaluation Board for CS3308

Features

- ◆ Single-ended Analog Inputs
- ◆ Single-ended Analog Outputs
- ◆ Supports AC and DC-Coupled Analog I/O
- ◆ Flexible Serial Control I/O Headers
 - Serial Control Input Header to Accommodate On-board and External Serial Controllers
 - Serial Control Output Headers for “Chaining” Serial Control Across Multiple CDB3308 Evaluation Boards
 - 3.3 V Logic Interface Level
- ◆ Demonstrates Recommended Layout and Grounding Arrangements
- ◆ Minimal Power Supply Requirements
 - ± 5 V and Ground
- ◆ Windows® Compatible Software Interface
 - Easy and Intuitive Graphical Interface to Channel and Master Volume Controls
 - Supports USB and RS-232 PC Connectivity

Description

The CDB3308 evaluation board is an excellent means for evaluating the CS3308 analog volume control. Evaluation requires an analog signal source and analyzer, power supplies, and a Windows PC compatible computer.

Standard RCA phono jacks are provided to easily interface external analog signals with the evaluation board. Each of the CS3308's inputs and outputs may be independently AC or DC-coupled to their respective I/O connectors.

The Windows software provides a GUI to make configuration of the CDB3308 easy. The software communicates through the PC's USB or Serial port to configure the control port registers so that all features of the CS3308 can be evaluated.

As an alternative to the serial control provided via a PC, the evaluation board may be configured to accept external control signals for operation in a user application during system development.

To facilitate multi-CS3308 system design efforts, headers are provided for connecting serial control signals between multiple CDB3308 evaluation boards.

ORDERING INFORMATION

CDB3308

Evaluation Board

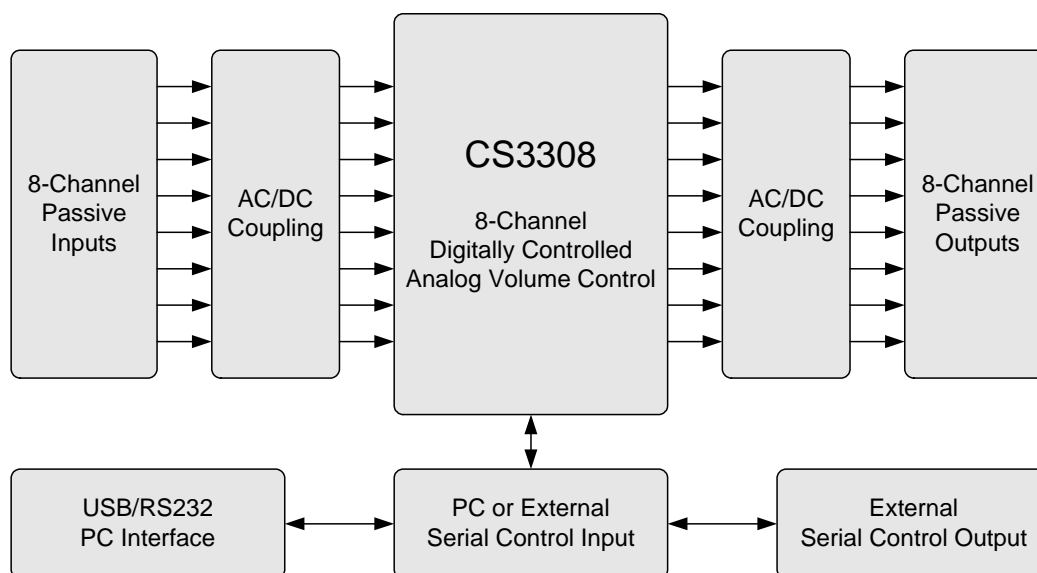

TABLE OF CONTENTS

1. SYSTEM OVERVIEW	3
1.1 Power	3
1.2 Grounding and Power Supply Decoupling	3
1.3 CS3308 Analog Volume Control	3
1.4 External Control Headers	3
1.5 Analog Inputs	4
1.6 Analog Outputs	4
1.7 PC Interfaces	4
2. PC SOFTWARE CONTROL	5
2.1 CS3308 Controls Tab	5
2.2 Register Maps Tab	6
3. PERFORMANCE PLOTS	7
4. SYSTEM CONNECTIONS & JUMPERS	8
5. CDB BLOCK DIAGRAM	9
6. CDB SCHEMATICS	10
7. CDB LAYOUT	13
8. REVISION HISTORY	16

LIST OF FIGURES

Figure 1.CS3308 Controls Tab	5
Figure 2.Register Maps Tab	6
Figure 3.Frequency Response	7
Figure 4.THD+N vs. Amplitude	7
Figure 5.THD+N vs. Frequency	7
Figure 6.Crosstalk	7
Figure 7.Block Diagram	9
Figure 8.CS3308	10
Figure 9.Analog Inputs and Outputs	11
Figure 10.Serial Control / Power	12
Figure 11.Silkscreen Top	13
Figure 12.Top Side Copper Layer	14
Figure 13.Bottom Side Copper Layer	15

LIST OF TABLES

Table 1. System Connections	8
Table 2. On-Board Switches	8
Table 3. System Headers	8

1. SYSTEM OVERVIEW

The CDB4265 evaluation board is an excellent means for evaluating the CS3308 digitally controlled analog volume control. Analog audio signal interfaces are provided, an on-board microcontroller and USB/RS-232 PC interface is used for easily configuring the CS3308's internal registers, and a USB cable is included for use with the FlexGUI Windows configuration software.

The CDB3308 schematic set is shown in [Figure 8](#) through [Figure 10](#).

1.1 Power

Power (± 5 V) must be supplied to the evaluation board through the red VA+ and green VA- binding posts. An on-board regulator provides a 3.3 V supply to the digital circuitry. All voltage inputs must be referenced to the single black binding post ground connector (see the [System Connections](#) table on [page 8](#)).

WARNING: Please refer to the CS3308 data sheet for allowable voltage levels.

1.2 Grounding and Power Supply Decoupling

The CS3308 requires careful attention to power supply and grounding arrangements to optimize performance. [Figure 7 on page 9](#) provides an overview of the connections to the CS3308. [Figure 11 on page 13](#) shows the component placement. [Figure 12 on page 14](#) shows the top layout. [Figure 13 on page 15](#) shows the bottom layout. The decoupling capacitors are located as close to the CS3308 as possible. Extensive use of ground plane fill in the evaluation board yields large reductions in radiated noise.

1.3 CS3308 Analog Volume Control

A complete description of the CS3308 is included in the CS3308 product data sheet.

The required configuration settings of the CS3308 are achieved via its control port registers, accessible through the CS3308 tab of the Cirrus Logic FlexGUI software. A register-level configuration interface is provided on the Register Maps tab. See the [“PC Software Control” section on page 5](#) for more information.

1.4 External Control Headers

The evaluation board has been designed to allow interfacing with external systems via the headers J17, J88, and J89.

The 15-pin, 3 column header, J17, provides bidirectional access to the CS3308's SPI™/I²C® and $\overline{\text{MUTE}}$ digital control signals. The pins located in the column labeled “PC” connect to the on-board PC interface circuitry, and those in the column labeled “In” connect directly to the CS3308's digital control I/O pins. By default, shunts are populated across these rows, connecting the PC interface to the CS3308's digital control I/O. To use an external digital control source, simply remove the shunts and connect a ribbon cable to the “In” position. A single “GND” column for the ribbon cable's ground connection is provided to maintain signal integrity. Two unpopulated pull-up resistors are also available should the CDB3308 be required to provide the pull-up function for the I²C bus.

The 10-pin, 2 column header, J89, provides bidirectional access to the CS3308's I²C SDA and SCL signals, as well as unidirectional output access to the CS3308's AD0, ENOut, and $\overline{\text{MUTE}}$ signals. The SDA and SCL signals are connected directly to their corresponding pins on the CS3308, as well as those on J17 described above. The AD0, ENOut, and $\overline{\text{MUTE}}$ signals are re-driven versions of these signals as present directly on their respective I/O pins on the CS3308. This header may be used to connect the serial control signals between 2 or more CDB3308's (out of J89 on one and in to J17 on another) for multiple CS3308 I²C serial control evaluation.

The 10-pin, 2 column header, J88, provides unidirectional output access to the CS3308's SPI MOSI and CCLK signals, as well as its ADO, ENOut, and MUTE signals. All of the signals re-driven versions of those present directly on their respective I/O pins on the CS3308. This header may be used to connect the serial control signals between 2 or more CDB3308's (out of J88 on one and in to J17 on another) for multiple CS3308 SPI serial control evaluation.

1.5 Analog Inputs

RCA connectors supply the CS3308 analog inputs through single-ended passive circuits with no input filtering. Refer to the CS3308 data sheet for the maximum input signal level.

Each analog input may be AC or DC coupled to its respective RCA connector. This selection is made via the 2-pin headers labeled "DC Couple Input" and placed adjacent to each input connector on the board. To DC couple an input connector, place a shunt across the respective header. To AC couple an input connector, remove the shunt from the respective header. By default, the input connectors are AC coupled to the CS3308's inputs.

1.6 Analog Outputs

The CS3308 analog outputs are routed through single-ended passive circuits with no output filtering and connected to RCA jacks for easy evaluation.

Each analog output may be AC or DC coupled to its respective RCA connector. This selection is made via the 2-pin headers labeled "DC Couple Output" and placed adjacent to each output connector on the board. To DC couple an output connector, place a shunt across the respective header. To AC couple an output connector, remove the shunt from the respective header. By default, the output connectors are AC coupled to the CS3308's outputs.

1.7 PC Interfaces

USB and RS-232 connections are provided to facilitate software control of the CS3308's internal registers.

A graphical user interface is available for the CDB3308 to allow easy manipulation of the CS3308's internal registers. See the CS3308 datasheet for complete internal register descriptions.

To enable the CDB3308, simply connect the supplied USB cable from an available USB port on a PC to the USB connector (J37), or alternatively connect a 9-pin serial cable from an available COM port on a PC to the RS-232 connector (J42) and launch the Cirrus Logic FlexGUI software.

Refer to "[PC Software Control](#)" on [page 5](#) for a description of the Graphical User Interface (GUI).

2. PC SOFTWARE CONTROL

The CDB3308 is designed for use with the Microsoft Windows based FlexGUI graphical user interface. This interface provides comprehensive control over the CS3308's internal registers via a PC's USB or RS-232 port.

The FlexGUI software may be downloaded and installed from www.cirrus.com/mssoftware.

Step-by-step instructions for using the FlexGUI are provided as follows:

1. Download and install the FlexGUI software from www.cirrus.com/mssoftware.
2. Connect the CDB3308 to a host PC using the supplied USB cable or a 9-pin serial cable.
3. Apply positive power, negative power, and ground to the VA+, VA-, and GND binding posts respectively.
4. Launch the FlexGUI software. *The GUI will load and be displayed.*
5. Un-check the "Power Down CS3308" check box to allow audio to pass through the device.

2.1 CS3308 Controls Tab

The CS3308 Controls tab provides a high-level intuitive interface to many of the configuration options of the CS3308. Control over the state of the CS3308's MUTE and RESET input pins is also provided.

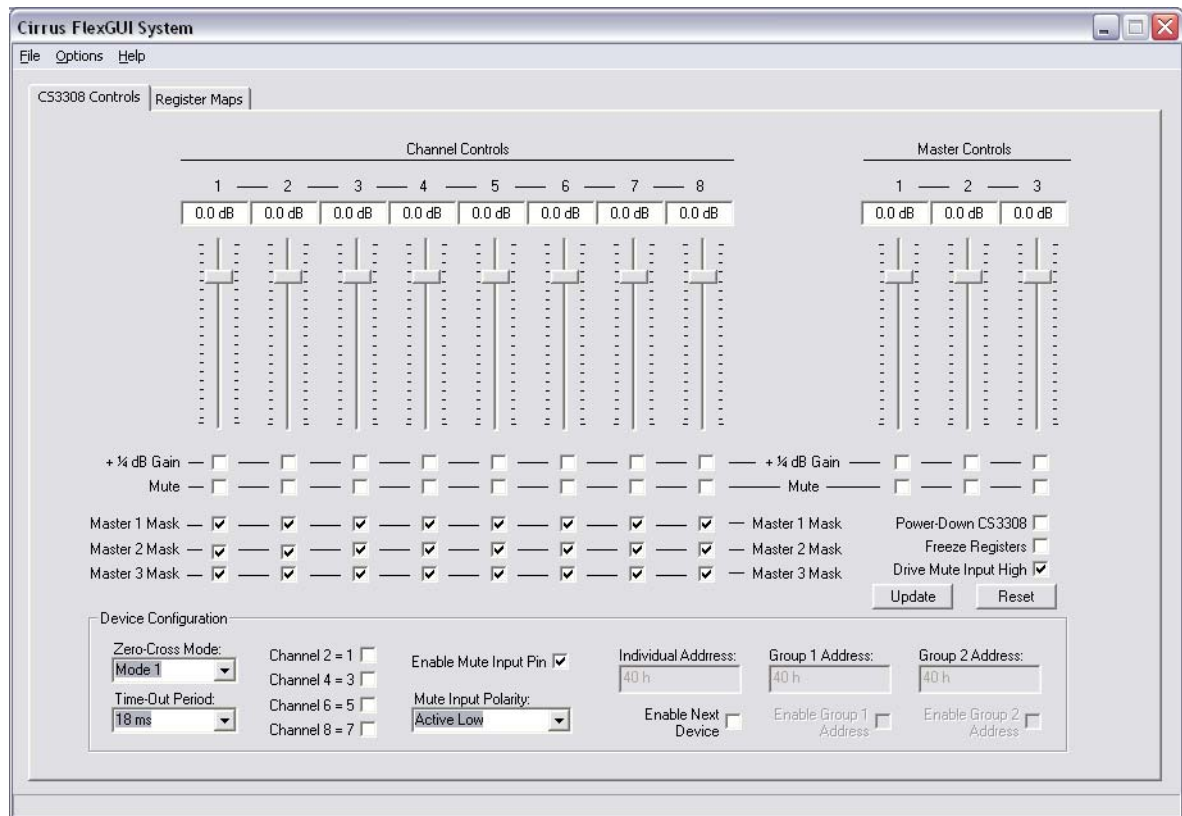

Figure 1. CS3308 Controls Tab

The *Master X Mask* check boxes are used to map each channel to the master controls. These check-boxes reflect the state of their associated *Master X Mask* bits; when checked, the channel is un-masked.

The sliders facilitate control over the *Ch X Volume* registers, providing gain and attenuation in ½ dB steps. The +¼ dB Gain check boxes are used to add an additional ¼ dB of gain to the volume level displayed for each channel.

See the CS3308 datasheet for complete internal register descriptions.

2.2 Register Maps Tab

The Register Maps tab provides an easy register-level interface to the on-board devices. Register values can be modified on a bit-wise or byte-wise basis. To modify a single bit, first select the register by clicking its position in the register matrix, then click the appropriate push-button for the desired bit. To modify an entire register, simply enter the register's new value directly into the register matrix.

Within the Register Maps tab, the CS3308 tab is used to access the CS3308's internal registers, and the GPIO tab is used to access the on-board microcontroller outputs used to control the CS3308's MUTE input and default I²C address.

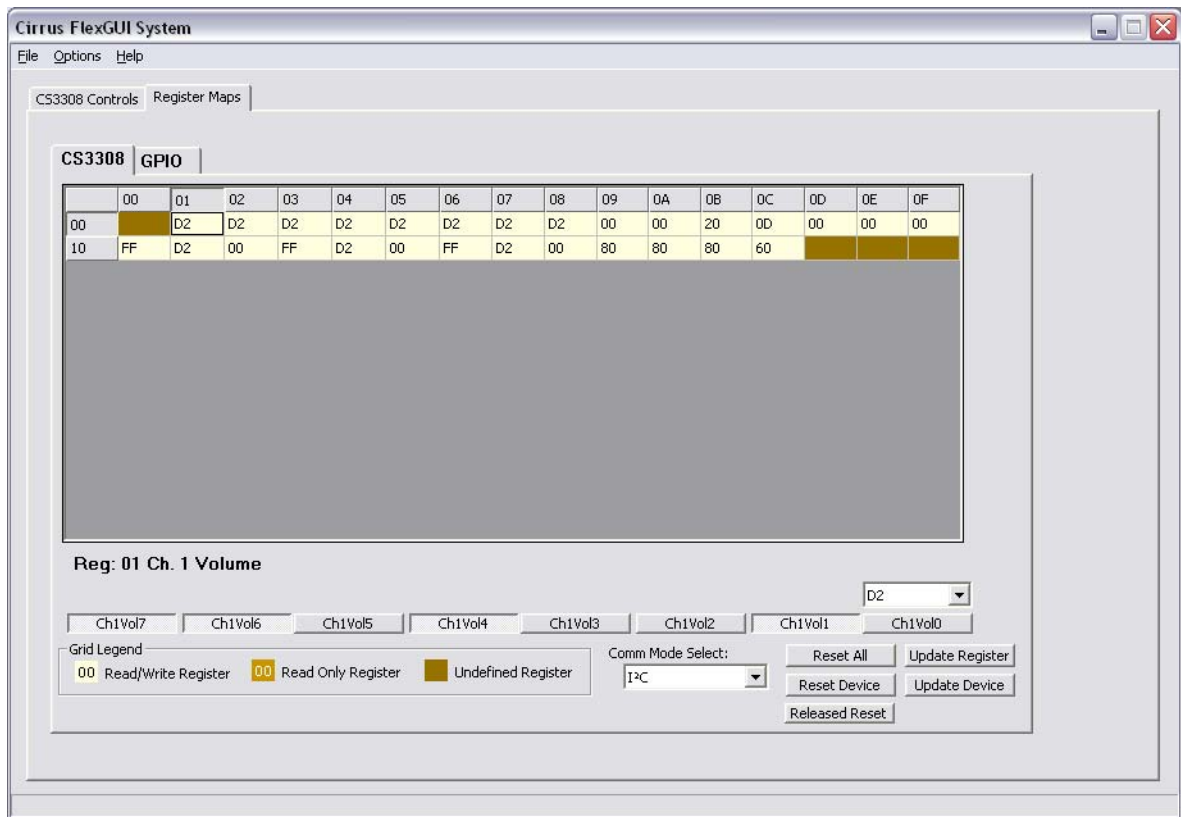

Figure 2. Register Maps Tab

The *Comm Mode Select* box may be used to change the CS3308's serial communication protocol between I²C and SPI. The CS3308 will be automatically reset when the communication protocol is changed.

The software is only capable of addressing the CS3308 at its default address. If the CS3308's individual address is changed, the software will lose communication with the device until it is reset, thereby returning to its default address. See the CS3308 datasheet for more information about the device's individual address.

3. PERFORMANCE PLOTS

($T_A = +25\text{ }^\circ\text{C}$, $V_{A+} = +5\text{ V}$, $V_{A-} = -5\text{ V}$, $V_D = +3.3\text{ V}$, $R_L = 100\text{ k}\Omega$, $C_L = 20\text{ pF}$, $V_{IN} = 2\text{ V}_{RMS}$, $F_{IN} = 1\text{ kHz}$, Gain = 0 dB, Measurement Bandwidth = 20 Hz to 20 kHz, unless otherwise noted.)

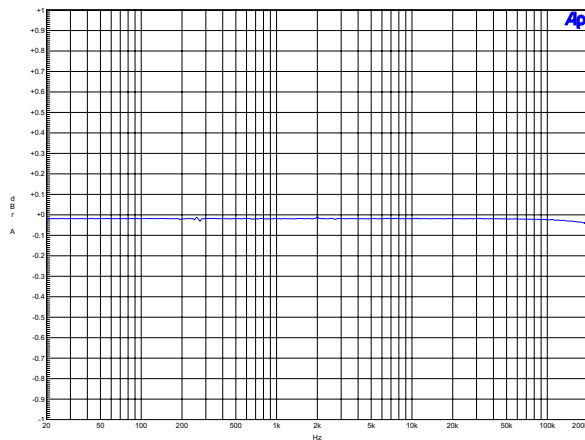

Figure 3. Frequency Response

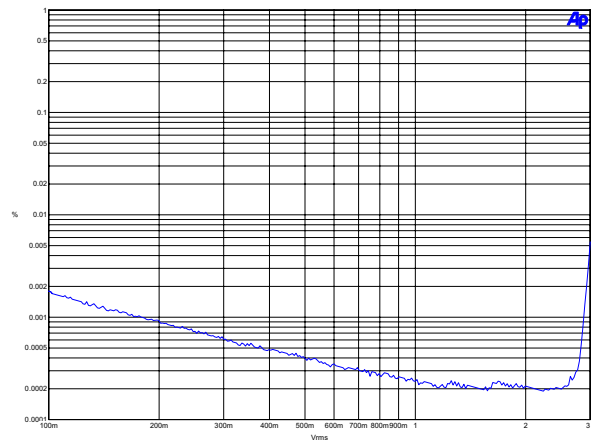

Figure 4. THD+N vs. Amplitude

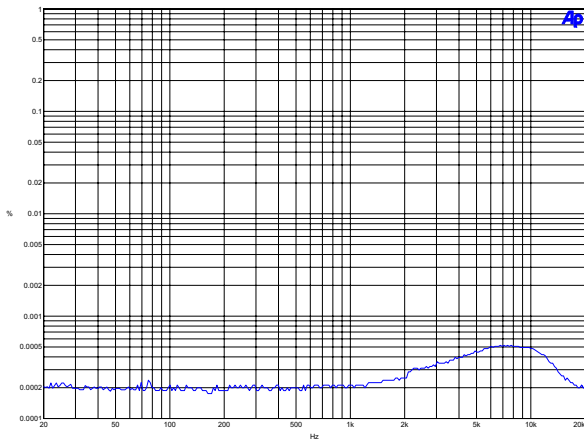

Figure 5. THD+N vs. Frequency

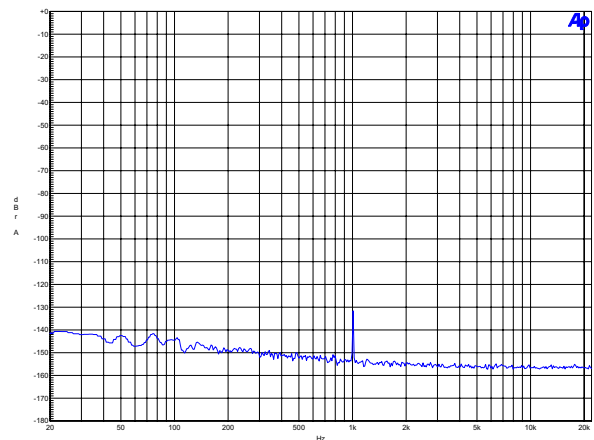

Figure 6. Crosstalk

4. SYSTEM CONNECTIONS & JUMPERS

Connector Name	Reference Designator	Signal Direction	Connector Function
GND	J5	Input	Ground reference.
VA+	J8	Input	Positive analog power. +5 V.
VA-	J7	Input	Negative analog power. -5 V.
In 1 In 2 In 3 In 4 In 5 In 6 In 7 In 8	J29 J27 J11 J15 J55 J57 J71 J73	Input	Analog input to CS3308.
Out 1 Out 2 Out 3 Out 4 Out 5 Out 6 Out 7 Out 8	J19 J21 J46 J48 J62 J64 J79 J81	Output	Analog output from CS3308.
USB I/O	J37	Input/Output	USB connection to PC for software control.
RS-232 I/O	J42	Input/Output	Serial RS-232 connection to PC for software control.
I ² C/SPI Input	J17	Input/Output	Connection for internal/external I ² C/SPI control signals.
I ² C Output	J89	Output	Output connection for on-board I ² C control signals.
SPI Output	J88	Output	Output connection for on-board SPI control signals.
C2	J36	Input/Output	Connection for programming the on-board microcontroller (U46).

Table 1. System Connections

Switch Name	Reference Designator	Switch Function
uC Reset	J5	Resets the on-board microcontroller (U46).

Table 2. On-Board Switches

Connector Name	Reference Designator	Header Function
DC Couple Input 1 DC Couple Input 2 DC Couple Input 3 DC Couple Input 4 DC Couple Input 5 DC Couple Input 6 DC Couple Input 7 DC Couple Input 8	J2 J3 J16 J18 J58 J59 J74 J75	When a shunt is present across its pins, each header DC couples its respective input connector to the associated input of the CS3308.
DC Couple Output 1 DC Couple Output 2 DC Couple Output 3 DC Couple Output 4 DC Couple Output 5 DC Couple Output 6 DC Couple Output 7 DC Couple Output 8	J32 J33 J51 J52 J67 J68 J84 J85	When no shunt is present across the header's pins, its respective input connector will be AC coupled to the associated input of the CS3308.
		When a shunt is present across its pins, each header DC couples its respective output connector to the associated output of the CS3308.
		When no shunt is present across the header's pins, its respective output connector will be AC coupled to the associated output of the CS3308.

Table 3. System Headers

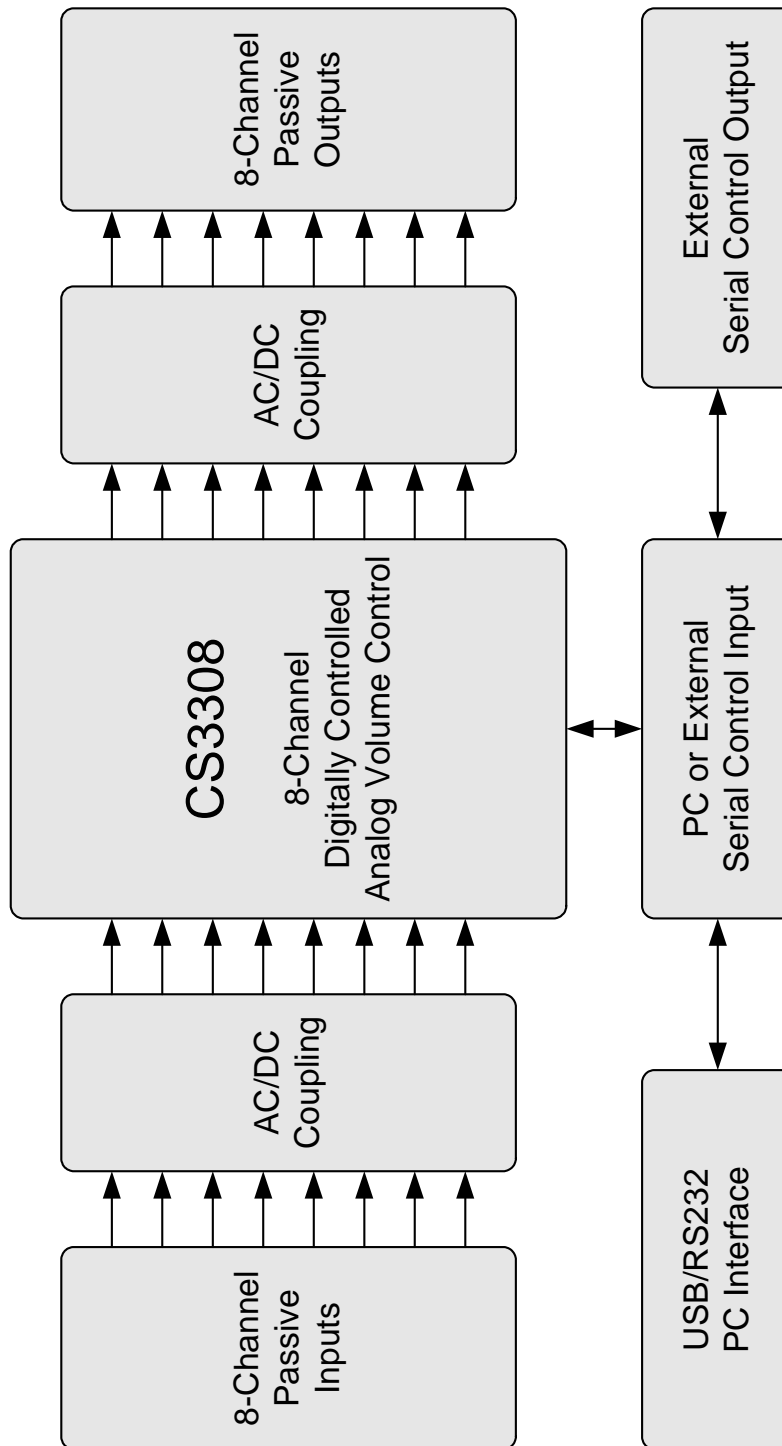
5. CDB BLOCK DIAGRAM

Figure 7. Block Diagram

6. CDB SCHEMATICS

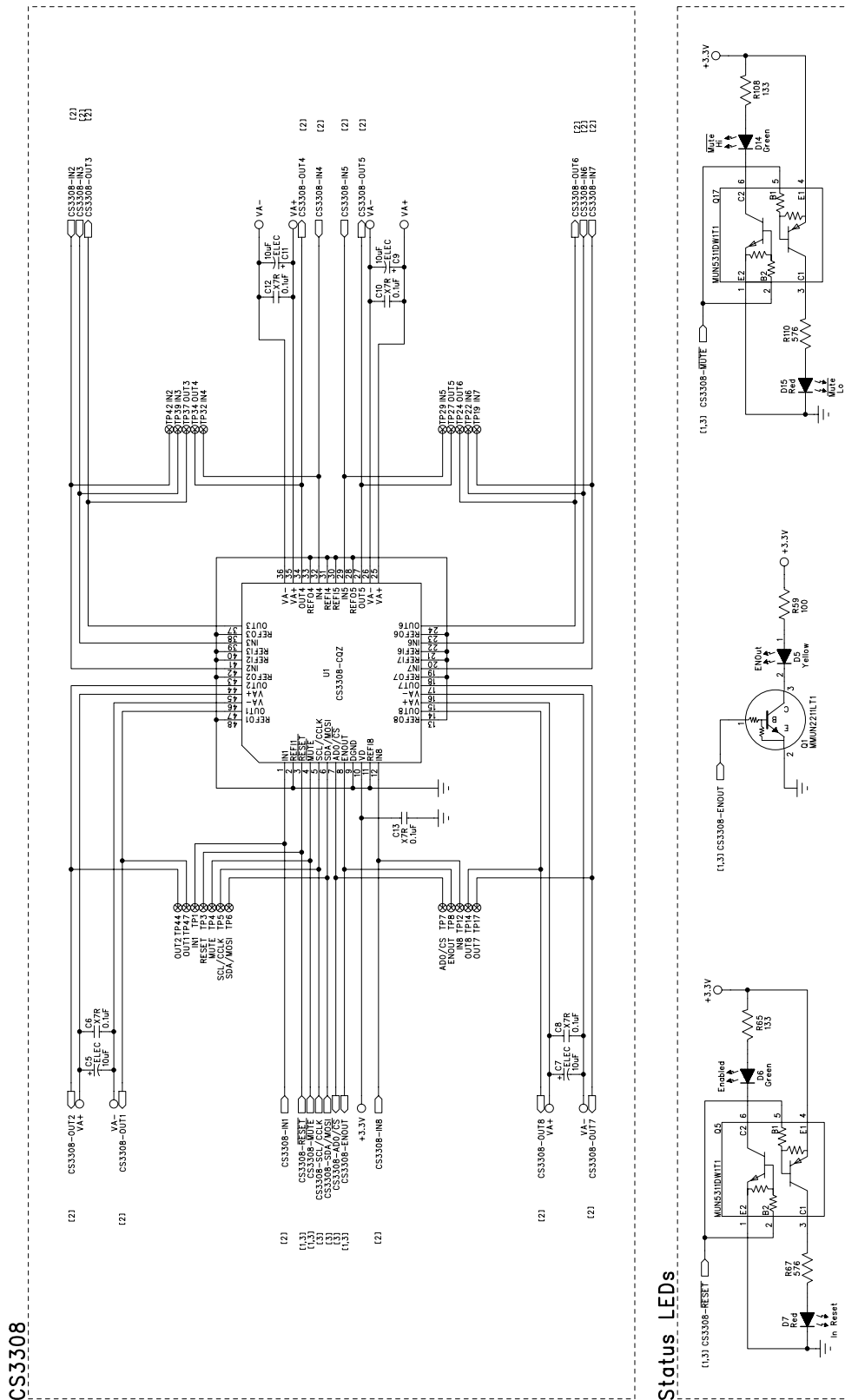

Figure 8. CS3308 Schematic Page 1

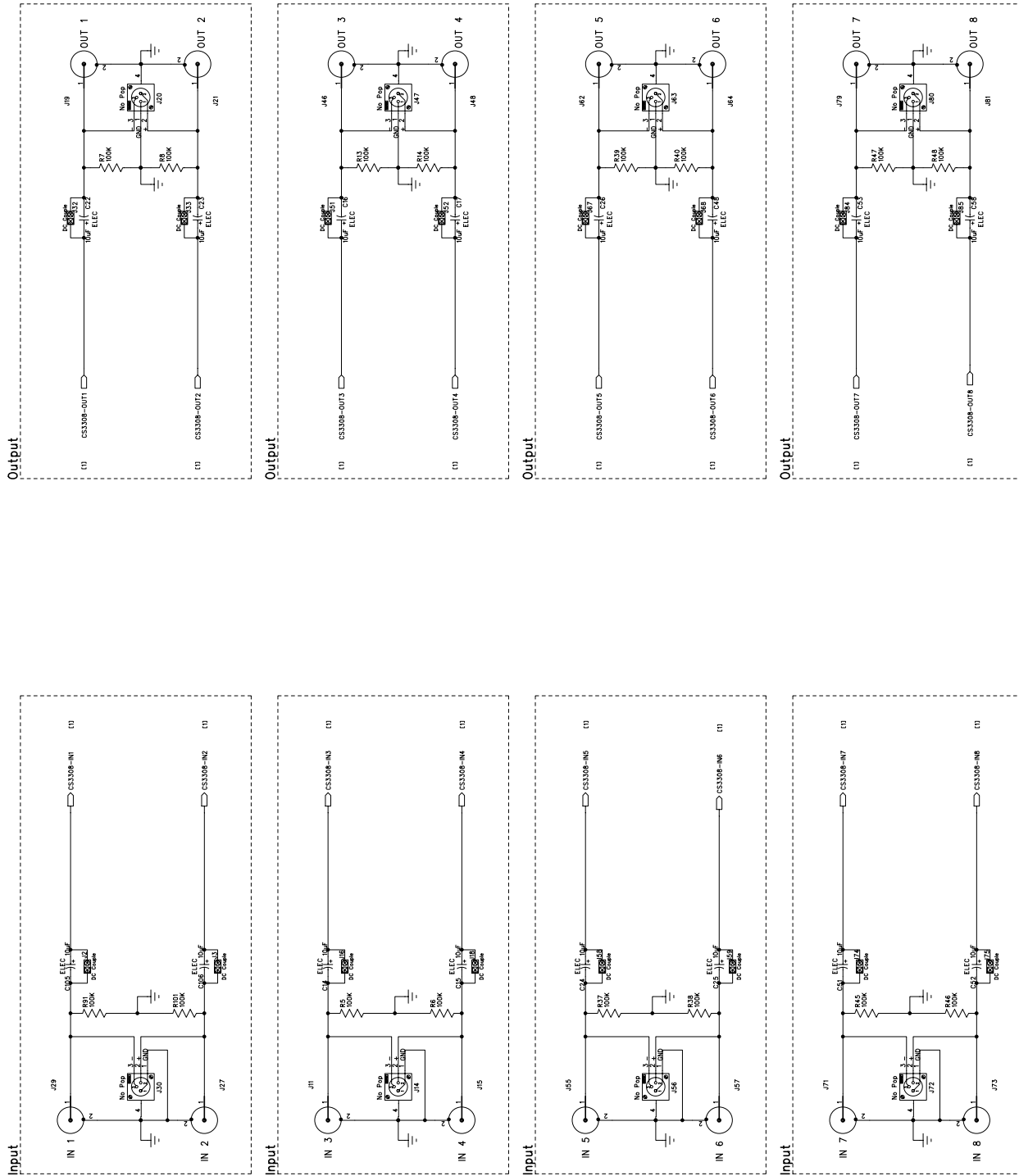

Figure 9. Analog Inputs and Outputs
Schematic Page 2

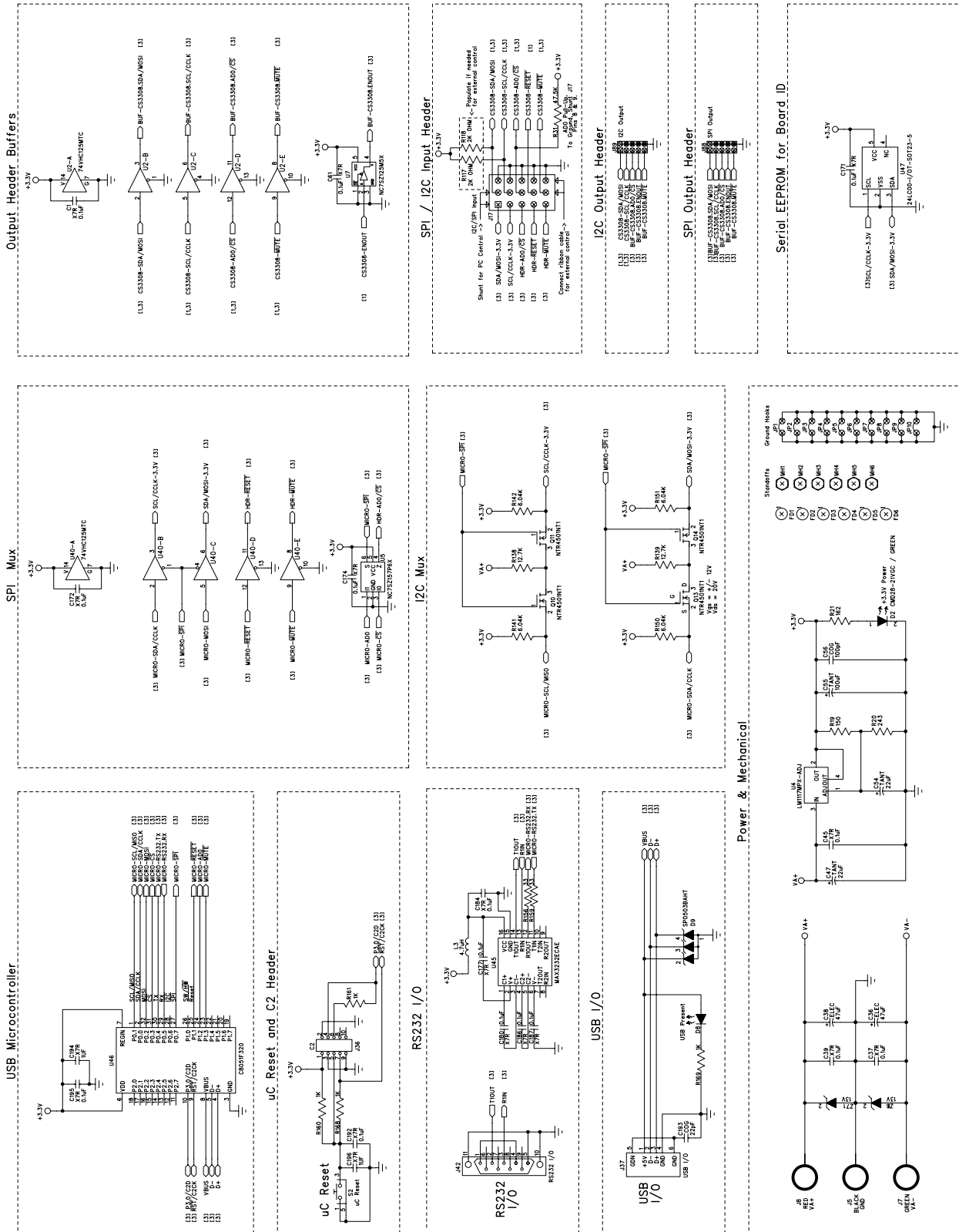

Figure 10. Serial Control / Power Schematic Page 3

7. CDB LAYOUT

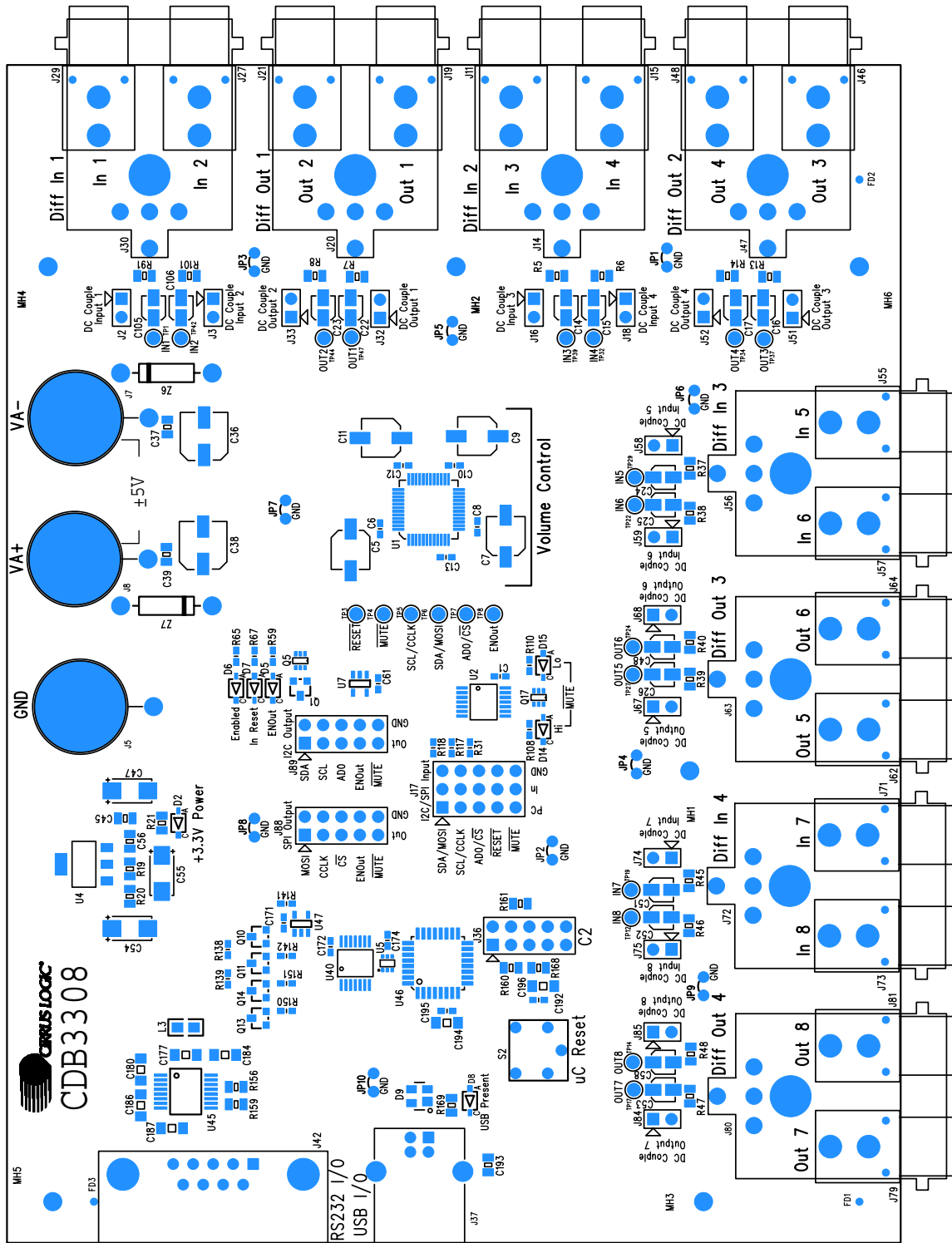

Figure 11. Silkscreen Top

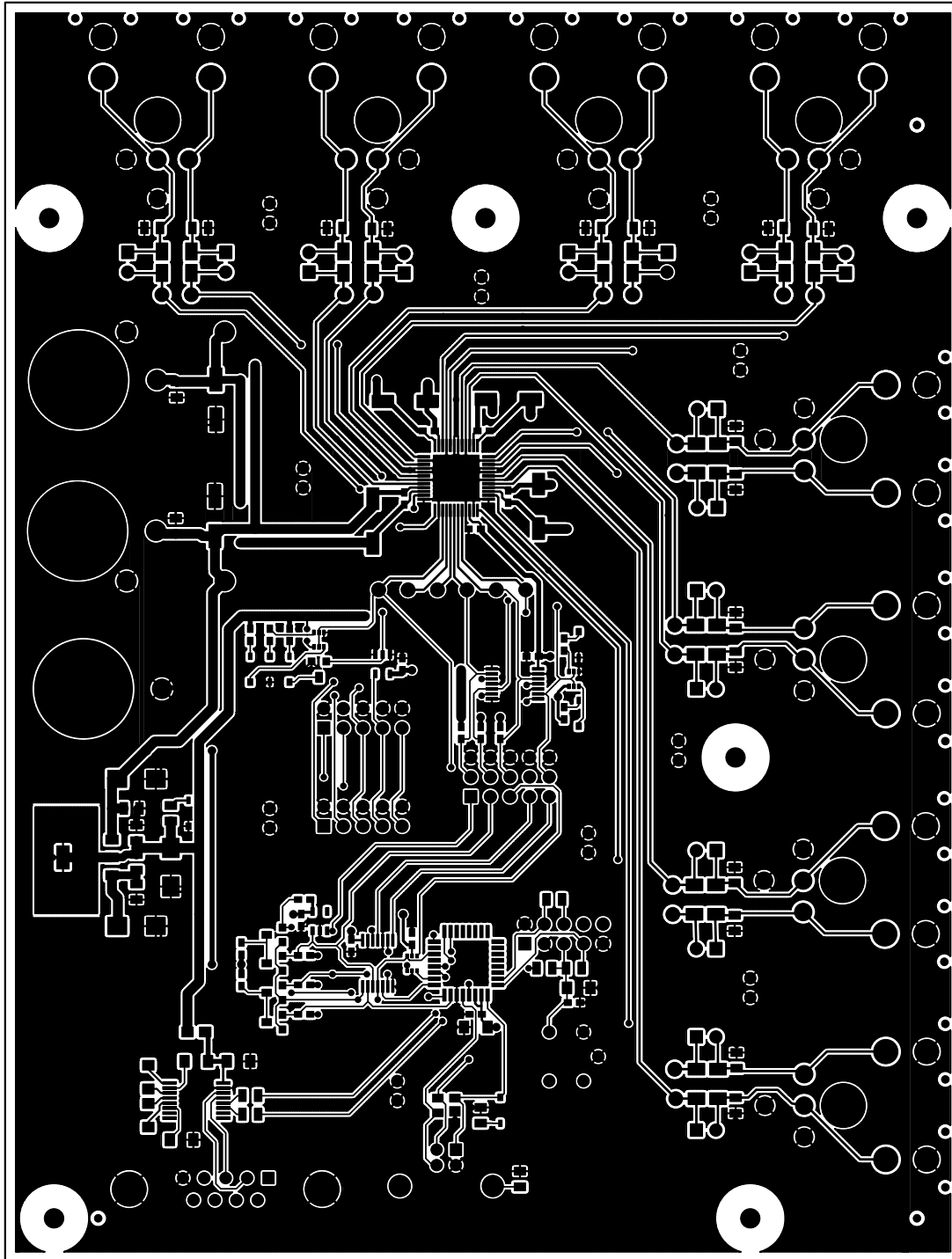

Figure 12. Top Side Copper Layer

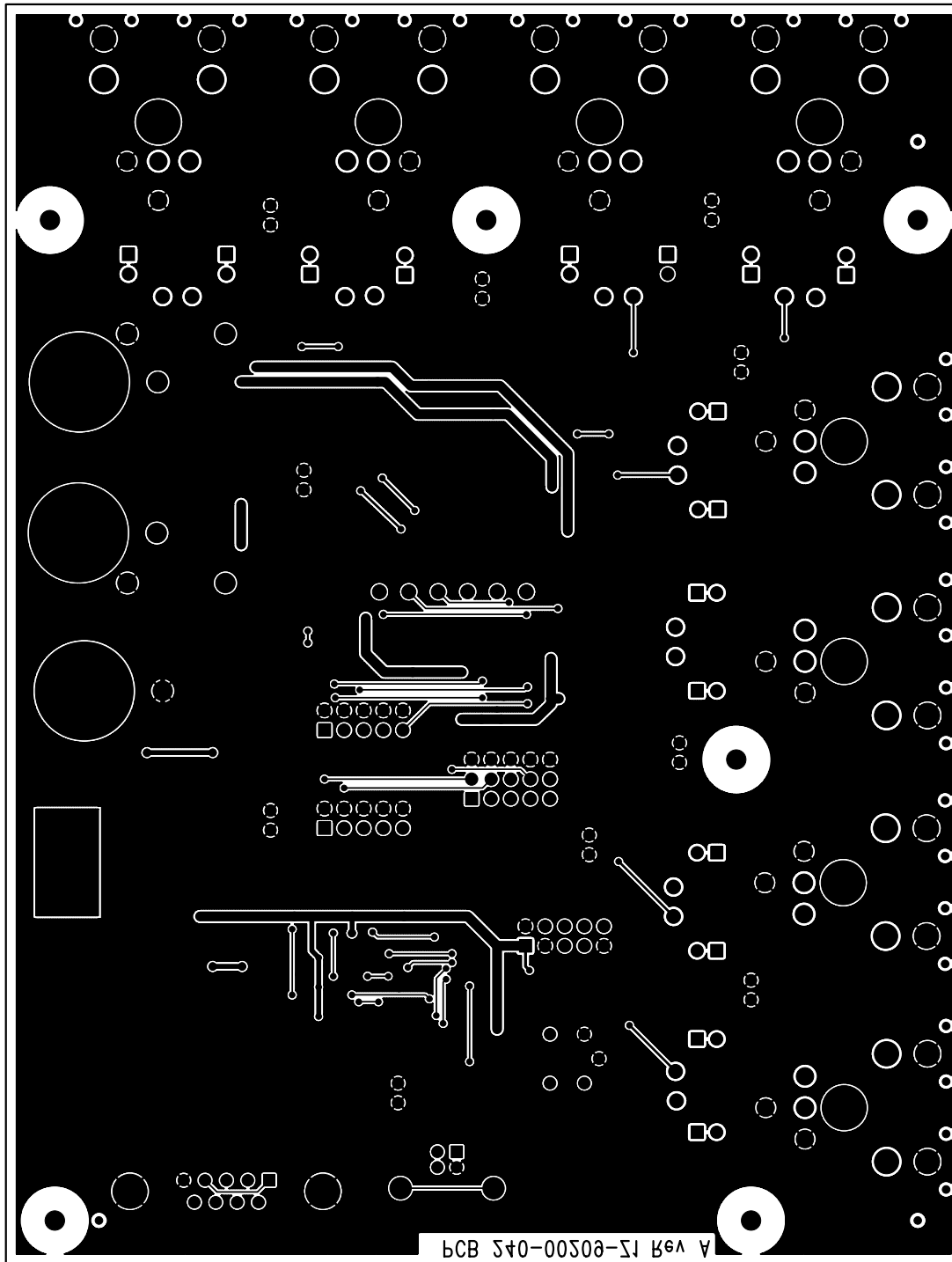

Figure 13. Bottom Side Copper Layer

8. REVISION HISTORY

Release	Changes
DB1	Initial Release
DB2	Updated performance plots shown in Figures 3 - 6 on page 7.

Contacting Cirrus Logic Support

For all product questions and inquiries, contact a Cirrus Logic Sales Representative.
To find the one nearest to you, go to www.cirrus.com.

IMPORTANT NOTICE

Cirrus Logic, Inc. and its subsidiaries ("Cirrus") believe that the information contained in this document is accurate and reliable. However, the information is subject to change without notice and is provided "AS IS" without warranty of any kind (express or implied). Customers are advised to obtain the latest version of relevant information to verify, before placing orders, that information being relied on is current and complete. All products are sold subject to the terms and conditions of sale supplied at the time of order acknowledgment, including those pertaining to warranty, indemnification, and limitation of liability. No responsibility is assumed by Cirrus for the use of this information, including use of this information as the basis for manufacture or sale of any items, or for infringement of patents or other rights of third parties. This document is the property of Cirrus and by furnishing this information, Cirrus grants no license, express or implied under any patents, mask work rights, copyrights, trademarks, trade secrets or other intellectual property rights. Cirrus owns the copyrights associated with the information contained herein and gives consent for copies to be made of the information only for use within your organization with respect to Cirrus integrated circuits or other products of Cirrus. This consent does not extend to other copying such as copying for general distribution, advertising or promotional purposes, or for creating any work for resale.

CERTAIN APPLICATIONS USING SEMICONDUCTOR PRODUCTS MAY INVOLVE POTENTIAL RISKS OF DEATH, PERSONAL INJURY, OR SEVERE PROPERTY OR ENVIRONMENTAL DAMAGE ("CRITICAL APPLICATIONS"). CIRRUS PRODUCTS ARE NOT DESIGNED, AUTHORIZED OR WARRANTED FOR USE IN AIRCRAFT SYSTEMS, MILITARY APPLICATIONS, PRODUCTS SURGICALLY IMPLANTED INTO THE BODY, AUTOMOTIVE SAFETY OR SECURITY DEVICES, LIFE SUPPORT PRODUCTS OR OTHER CRITICAL APPLICATIONS. INCLUSION OF CIRRUS PRODUCTS IN SUCH APPLICATIONS IS UNDERSTOOD TO BE FULLY AT THE CUSTOMER'S RISK AND CIRRUS DISCLAIMS AND MAKES NO WARRANTY, EXPRESS, STATUTORY OR IMPLIED, INCLUDING THE IMPLIED WARRANTIES OF MERCHANTABILITY AND FITNESS FOR PARTICULAR PURPOSE, WITH REGARD TO ANY CIRRUS PRODUCT THAT IS USED IN SUCH A MANNER. IF THE CUSTOMER OR CUSTOMER'S CUSTOMER USES OR PERMITS THE USE OF CIRRUS PRODUCTS IN CRITICAL APPLICATIONS, CUSTOMER AGREES, BY SUCH USE, TO FULLY INDEMNIFY CIRRUS, ITS OFFICERS, DIRECTORS, EMPLOYEES, DISTRIBUTORS AND OTHER AGENTS FROM ANY AND ALL LIABILITY, INCLUDING ATTORNEYS' FEES AND COSTS, THAT MAY RESULT FROM OR ARISE IN CONNECTION WITH THESE USES.

Cirrus Logic, Cirrus, and the Cirrus Logic logo designs are trademarks of Cirrus Logic, Inc. All other brand and product names in this document may be trademarks or service marks of their respective owners.

SPI is a trademark of Motorola, Inc.

IP3 is a registered trademark of Philips Semiconductor.

Windows is a registered trademark of Microsoft Corporation.

Mouser Electronics

Authorized Distributor

Click to View Pricing, Inventory, Delivery & Lifecycle Information:

[Cirrus Logic:](#)

[CDB3308](#)

Компания «Океан Электроники» предлагает заключение долгосрочных отношений при поставках импортных электронных компонентов на взаимовыгодных условиях!

Наши преимущества:

- Поставка оригинальных импортных электронных компонентов напрямую с производств Америки, Европы и Азии, а так же с крупнейших складов мира;
- Широкая линейка поставок активных и пассивных импортных электронных компонентов (более 30 млн. наименований);
- Поставка сложных, дефицитных, либо снятых с производства позиций;
- Оперативные сроки поставки под заказ (от 5 рабочих дней);
- Экспресс доставка в любую точку России;
- Помощь Конструкторского Отдела и консультации квалифицированных инженеров;
- Техническая поддержка проекта, помощь в подборе аналогов, поставка прототипов;
- Поставка электронных компонентов под контролем ВП;
- Система менеджмента качества сертифицирована по Международному стандарту ISO 9001;
- При необходимости вся продукция военного и аэрокосмического назначения проходит испытания и сертификацию в лаборатории (по согласованию с заказчиком);
- Поставка специализированных компонентов военного и аэрокосмического уровня качества (Xilinx, Altera, Analog Devices, Intersil, Interpoint, Microsemi, Actel, Aeroflex, Peregrine, VPT, Syfer, Eurofarad, Texas Instruments, MS Kennedy, Miteq, Cobham, E2V, MA-COM, Hittite, Mini-Circuits, General Dynamics и др.);

Компания «Океан Электроники» является официальным дистрибьютором и эксклюзивным представителем в России одного из крупнейших производителей разъемов военного и аэрокосмического назначения «JONHON», а так же официальным дистрибьютором и эксклюзивным представителем в России производителя высокотехнологичных и надежных решений для передачи СВЧ сигналов «FORSTAR».



JONHON

«JONHON» (основан в 1970 г.)

Разъемы специального, военного и аэрокосмического назначения:

(Применяются в военной, авиационной, аэрокосмической, морской, железнодорожной, горно- и нефтедобывающей отраслях промышленности)

«FORSTAR» (основан в 1998 г.)

ВЧ соединители, коаксиальные кабели, кабельные сборки и микроволновые компоненты:

(Применяются в телекоммуникациях гражданского и специального назначения, в средствах связи, РЛС, а так же военной, авиационной и аэрокосмической отраслях промышленности).



Телефон: 8 (812) 309-75-97 (многоканальный)

Факс: 8 (812) 320-03-32

Электронная почта: ocean@oceanchips.ru

Web: <http://oceanchips.ru/>

Адрес: 198099, г. Санкт-Петербург, ул. Калинина, д. 2, корп. 4, лит. А