

3M™ ROUND, SHIELDED/JACKETED, FLAT CABLE, HF659 SERIES

.050" 28 AWG STRANDED, MASS TERMINATABLE, HALOGEN FREE PO/PO

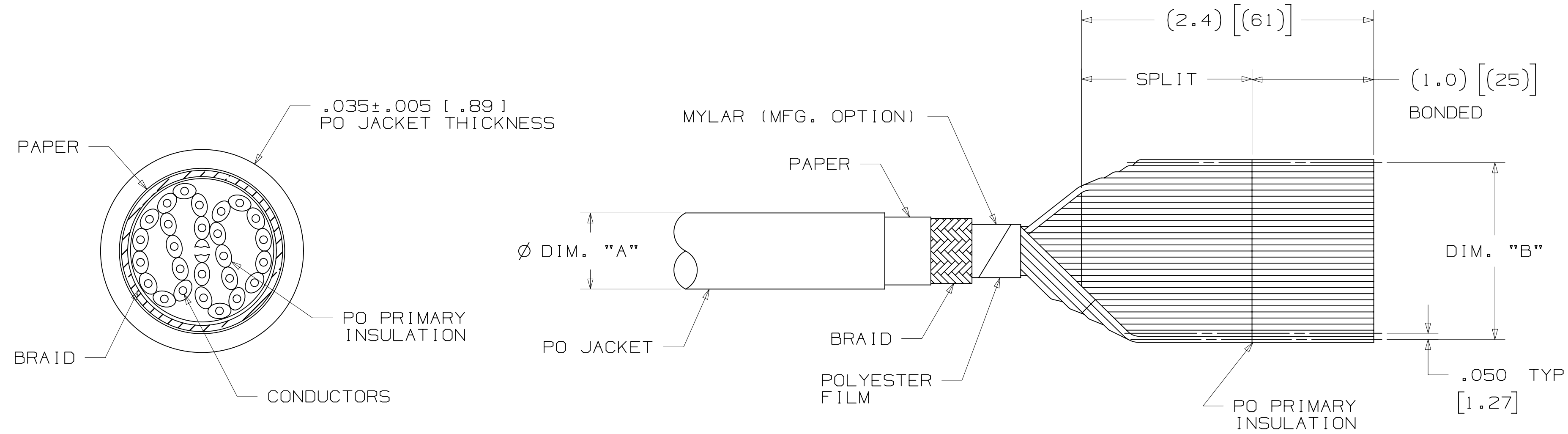

NOTE:
 1) BLUE MARKING ON ONE EDGE OF PRIMARY CABLE DESIGNATES WIRE #1.
 2) DIMENSION "B" PERTAINS TO BONDED AREA ONLY.

- * LOW SMOKE ZERO HALOGEN (LSZH) INSULATION. ADVANTAGES OF LSZH INSULATION ARE THE LOW SMOKE (IEC 61034-2-2005) AND LOW TOXICITY OF COMBUSTION GASES (NF X 70-100-2-2006), REDUCING THE RISK TO FIREFIGHTERS AND REDUCING THE SOOT AND CORROSION DAMAGE TO NEARBY EQUIPMENT.
- * ROUND CONSTRUCTION PERMITS MORE EASY ROUTING.
- * 28 AWG WIRE ON .050 INCH CENTERS PERMITS MASS TERMINATION TO BROAD LINE OF IDC CONNECTORS.
- * CONTINUOUS SPLIT/BOND REPEAT ALLOWS FOR MASS TERMINATIONS OF IDC CONNECTORS.
- * DUAL SHIELDING PROVIDES 35 db AVERAGE SHIELDING.
- * PRIMARY CABLE IS ZIPPABLE FOR BRANCHING OR DISCRETE TERMINATION.

NOTES
 1. REGULATORY INFORMATION: VISIT 3M.com/regs OR CONTACT YOUR 3M REPRESENTATIVE TO FIND THE RoHS COMPLIANCE STATUS OF THE 3M PART YOU ARE INTERESTED IN.
 2. IN THE EVENT OF CONFLICT BETWEEN THIS DATA AND THAT CONTAINED IN THE PRODUCT SPECIFICATION, THE PRODUCT SPECIFICATION TAKES PRECEDENT.

ORDERING INFORMATION

HF659/XX XX XX

NUMBER OF CONDUCTORS (SEE TABLE 1) BLANK = STANDARD
 SF = SPLICED FREE

BLANK = STANDARD
 SO = CONTINUOUSLY BONDED WIRE (NO SPLIT)

NOTE:
 AVAILABLE IN STANDARD 275FT ROLLS. CONTACT 3M FOR AVAILABILITY OF ADDITIONAL CONDUCTOR COUNTS AND/OR CUSTOM ROLL LENGTHS.

2 PHYSICAL :

JACKET MATERIAL: HALOGEN FREE POLYOLEFIN (PO)
 COLOR: DARK GRAY
 PRIMARY MATERIAL: HALOGEN FREE POLYOLEFIN (PO)
 COLOR: DARK GRAY

MARKING: NONE
 STANDARD: NONE
 CONDUCTORS: 28 AWG, 7 X 36 AWG [7 X Ø .127] TINNED STRANDED COPPER
 SHIELDING: .001 [.03] THICK ALUMINUM/POLYESTER FILM FOIL AND 90% COVERAGE TINNED COPPER BRAID.

2 ELECTRICAL :

VOLTAGE RATING: USA 150V CANADIAN 150V EU: <50V
 INSULATION RESISTANCE: (PRIMARY CABLE) >1 X 10¹⁰Ω/10ft. [3m]

CHARACTERISTIC	UNBALANCED	BALANCED
CHARACTERISTIC IMPEDANCE:	54Ω	107Ω
CAPACITANCE:	28.7 pF/ft [84.2 pF/m]	14.4 pF/ft [47.2 pF/m]
INDUCTANCE:	.08μH/ft [.27μH/m]	.16μH/ft [.52μH/m]
PROPAGATION DELAY:	1.55 ns/ft [4.95 ns/m]	1.54 ns/ft [4.95 ns/m]
VELOCITY OF PROPAGATION:	66%	66%

NOTE: UNBALANCED IS MEASURED BETWEEN GROUND-SIGNAL-GROUND CONDUCTORS.
 BALANCED IS MEASURED BETWEEN CONDUCTORS WITHIN A PAIR.
 MEASURED VALUES ARE TYPICAL

2 ENVIRONMENTAL :

TEMPERATURE RATING: -40°C TO +105°C (EIA-364-32G, METHOD A, TEST CONDITION 2)
 -15°C TO +75°C (UL TEMPERATURE RATING)
 FLAMMABILITY RATING: INTERNAL: HORIZONTAL FLAME PER UL758
 EXTERNAL: CABLE FLAME (VERTICAL) PER UL758

HALOGEN FREE IS DEFINED AS BOTH 1) NO HALOGEN COMPOUNDS THAT ARE INTENTIONALLY ADDED TO THE PRODUCT OR USED IN THE MANUFACTURING PROCESS FOR THE PRODUCT AND 2) ANY IMPURITIES PRESENT ARE LESS THAN 900ppm BROMINE, LESS THAN 900ppm CHLORINE AND/OR LESS THAN 1500ppm TOTAL BROMINE AND CHLORINE. THE LATTER ARE THE LEVELS SET FORTH IN CERTAIN INDUSTRY STANDARDS FOR PRINTED CIRCUIT BOARDS, SUCH AS THE INTERNATIONAL ELECTROTECHNICAL COMMISSION (IEC) 61249-2-21 STANDARDS. THIS INFORMATION REPRESENTS 3M'S KNOWLEDGE AND BELIEF WHICH MAY BE BASED IN WHOLE OR IN PART ON INFORMATION PROVIDED BY 3RD PARTY SUPPLIERS TO 3M.

NO. OF CONDUCTORS	3M PART NUMBER	DIM. "A"	DIM. "B"
09	HF659/09	.25 [6.4]	.40 [10.2]
10	HF659/10	.25 [6.4]	.45 [11.4]
14	HF659/14	.30 [7.6]	.65 [16.5]
15	HF659/15	.30 [7.6]	.70 [17.8]
16	HF659/16	.30 [7.6]	.75 [19.1]
20	HF659/20	.33 [8.4]	.95 [24.1]
24	HF659/24	.34 [8.6]	1.15 [29.2]
25	HF659/25	.34 [8.6]	1.20 [30.5]
26	HF659/26	.34 [8.6]	1.25 [31.8]
30	HF659/30	.37 [9.4]	1.45 [36.8]
34	HF659/34	.37 [9.4]	1.65 [41.9]
36	HF659/36	.41 [10.4]	1.75 [44.5]
37	HF659/37	.41 [10.4]	1.80 [45.7]
40	HF659/40	.41 [10.4]	1.95 [49.5]
50	HF659/50	.45 [11.4]	2.45 [62.2]
60	HF659/60	.48 [12.2]	2.95 [74.9]
64	HF659/64	.48 [12.2]	3.15 [80.0]

3M ELECTRONICS MATERIALS SOLUTIONS DIVISION
 INTERCONNECT SOLUTIONS
<http://www.3mconnectors.com>
 3M IS A TRADEMARK OF 3M COMPANY.
 FOR TECHNICAL, SALES OR ORDERING INFORMATION CALL 800-225-5373



INCH [MM]		
TOLERANCE - UNLESS NOTED		
.X	.XX	.XXX
[INCH] ±.1	±.05	±.010
[] = DIM. FOR REFERENCE ONLY		

DESIGN REFERENCE	NEXT ASSEMBLY	REV	ECO	ISSUE DATE AND DESCRIPTION	DRFT	CHKD
APPROVED	DATE	DATE	DATE	DATE	DATE	DATE
DIVISION		DIVISION CODE		EMSD		
DO NOT SCALE DRAWING		SCALE		TOLERANCES EXCEPT AS NOTED		
THIRD ANGLE PROJECTION		INCHES		MILLIMETERS		
MAX SURFACE ROUGHNESS		SURFACES		MARKED ONLY		
3M		© 3M COPYRIGHT 2018		This document and the information it contains are 3M property and may not be reproduced or further distributed without 3M permission, or used or disclosed other than for 3M authorized purposes. All rights reserved.		
TITLE		ROUND, SHIELDED / JACKETED, FLAT, CABLE, .050", HF659				
CAGE NUMBER	SIZE	DRAWING NO.	REV.			
D		78-5100-2335-7	E			
MODEL	HF659	DET	ISTS	YES	NO	SHT 1 OF 2

8 7 6 5 4 3 2 1

3M™ ROUND, SHIELDED/JACKETED, FLAT CABLE, HF659 SERIES
 .050" 28 AWG STRANDED, MASS TERMINATABLE, HALOGEN FREE PO/PO

Regulatory: For regulatory information about this product, visit 3M.com/regs or contact your 3M representative.

Technical Information: The technical information, recommendations and other statements contained in this document are based upon tests or experience that 3M believes are reliable, but the accuracy or completeness of such information is not guaranteed.

Product Use: Many factors beyond 3M's control and uniquely within user's control can affect the use and performance of a 3M product in a particular application. Given the variety of factors that can affect the use and performance of a 3M product, user is solely responsible for evaluating the 3M product and determining whether it is fit for a particular purpose and suitable for user's method of application.

Warranty, Limited Remedy, and Disclaimer: Unless an additional warranty is specifically stated on the applicable 3M product packaging or product literature, 3M warrants that each 3M product meets the applicable 3M product specification at the time 3M ships the product. 3M MAKES NO OTHER WARRANTIES OR CONDITIONS, EXPRESS OR IMPLIED, INCLUDING, BUT NOT LIMITED TO, ANY IMPLIED WARRANTY OR CONDITION OF MERCHANTABILITY OR FITNESS FOR A PARTICULAR PURPOSE OR ANY IMPLIED WARRANTY OR CONDITION ARISING OUT OF A COURSE OF DEALING, CUSTOM OR USAGE OR TRADE. If the 3M product does not conform to this warranty, then the sole and exclusive remedy is, at 3M's option, replacement of the 3M product or refund of the purchase price.

Limitation of Liability: Except where prohibited by law, 3M will not be liable for any loss or damage arising from the 3M product, whether direct, indirect, special, incidental or consequential, regardless of the legal theory asserted, including warranty, contract, negligence or strict liability.

3M Electronics Materials Solutions Division
 6801 River Place Blvd.
 Austin, TX 78726-9000
 1-800-225-5373
 www.3M.com/interconnect

DESIGN REFERENCE	NEXT ASSEMBLY	REV	ECO	ISSUE DATE AND DESCRIPTION	DRFT	CHKD
DO NOT SCALE DRAWING	SCALE	TOLERANCES EXCEPT AS NOTED	 © 3M COPYRIGHT 2018 This document and the information it contains are 3M property and may not be reproduced or further distributed without 3M permission, or used or disclosed other than for 3M authorized purposes. All rights reserved.			
THIRD ANGLE PROJECTION	INTERPRET PER ASME Y14.5 - 2009	MILLIMETERS	TITLE ROUND, SHIELDED / JACKETED, FLAT, CABLE, .050", HF659			
MAX SURFACE ROUGHNESS	MARKED ONLY	INCHES	CAGE NUMBER	SIZE	DRAWING NO.	REV.
			D	78-5100-2335-7	E	
			MODEL	HF659	DET	LISTS <input type="checkbox"/> YES <input checked="" type="checkbox"/> NO SHT 2 OF 2

E REVISION
 78-5100-2335-7 DRAWING NUMBER
 B
 A
 Time 8/1/2018 11:51:00 AM UTC Offset (hrs) 6

Компания «Океан Электроники» предлагает заключение долгосрочных отношений при поставках импортных электронных компонентов на взаимовыгодных условиях!

Наши преимущества:

- Поставка оригинальных импортных электронных компонентов напрямую с производств Америки, Европы и Азии, а так же с крупнейших складов мира;
- Широкая линейка поставок активных и пассивных импортных электронных компонентов (более 30 млн. наименований);
- Поставка сложных, дефицитных, либо снятых с производства позиций;
- Оперативные сроки поставки под заказ (от 5 рабочих дней);
- Экспресс доставка в любую точку России;
- Помощь Конструкторского Отдела и консультации квалифицированных инженеров;
- Техническая поддержка проекта, помощь в подборе аналогов, поставка прототипов;
- Поставка электронных компонентов под контролем ВП;
- Система менеджмента качества сертифицирована по Международному стандарту ISO 9001;
- При необходимости вся продукция военного и аэрокосмического назначения проходит испытания и сертификацию в лаборатории (по согласованию с заказчиком);
- Поставка специализированных компонентов военного и аэрокосмического уровня качества (Xilinx, Altera, Analog Devices, Intersil, Interpoint, Microsemi, Actel, Aeroflex, Peregrine, VPT, Syfer, Eurofarad, Texas Instruments, MS Kennedy, Miteq, Cobham, E2V, MA-COM, Hittite, Mini-Circuits, General Dynamics и др.);

Компания «Океан Электроники» является официальным дистрибьютором и эксклюзивным представителем в России одного из крупнейших производителей разъемов военного и аэрокосмического назначения «JONHON», а так же официальным дистрибьютором и эксклюзивным представителем в России производителя высокотехнологичных и надежных решений для передачи СВЧ сигналов «FORSTAR».



JONHON

«JONHON» (основан в 1970 г.)

Разъемы специального, военного и аэрокосмического назначения:

(Применяются в военной, авиационной, аэрокосмической, морской, железнодорожной, горно- и нефтедобывающей отраслях промышленности)

«FORSTAR» (основан в 1998 г.)

ВЧ соединители, коаксиальные кабели, кабельные сборки и микроволновые компоненты:

(Применяются в телекоммуникациях гражданского и специального назначения, в средствах связи, РЛС, а так же военной, авиационной и аэрокосмической отраслях промышленности).



Телефон: 8 (812) 309-75-97 (многоканальный)

Факс: 8 (812) 320-03-32

Электронная почта: ocean@oceanchips.ru

Web: <http://oceanchips.ru/>

Адрес: 198099, г. Санкт-Петербург, ул. Калинина, д. 2, корп. 4, лит. А