

Pxxx0ME 5kA SIDACtor Series® in TO-218

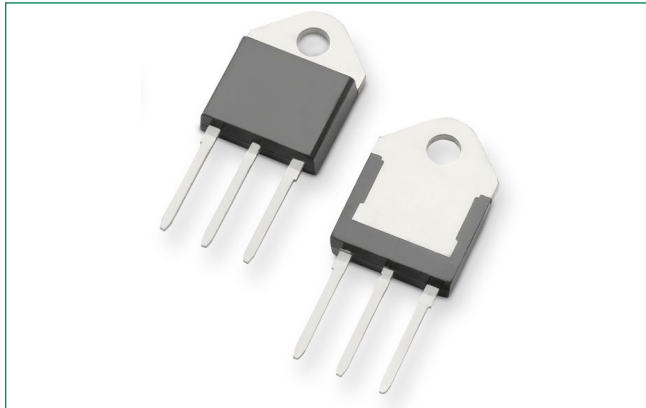

Description

The 5kA series SIDACtor® components are designed to protect equipment located in high exposure environments from severe overvoltage transients.

Setup in a robust TO-218 package, the 5kA series are ideal for use in data interface and AC power line for CATV amplifiers, Telecom Base Station equipment and Cell Towers.

Agency Approvals

| Agency | Agency File Number |
|---|--------------------|
|  | E133083 |

Pinout Designation

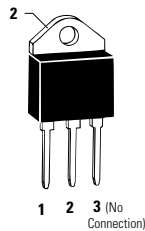

Features and Benefits

- Low voltage overshoot
- Low on-state voltage
- Does not degrade surge capability after multiple surge events within limit.
- Fails short circuit when surged in excess of rating
- Rugged TO-218 package
- 5000A 8/20 μ s surge rating
- Pb-free E3 means 2nd level interconnect is Pb-free and the terminal finish material is tin(Sn) (IPC/JEDEC J-STD-609A.01)
- RoHS compliant, lead-free and halogen-free
- UL Recognized as an Isolated Loop Circuit Protector to UL 497B

Schematic Symbol



Applicable Global Standards

- TIA-968-A
- TIA-968-B
- ITU K.20/21/45 Enhanced Level
- ITU K.20/21/45 Basic Level
- GR 1089 Intra-building
- IEC 61000-4-5 2nd Edition
- YD/T 1082
- YD/T 993
- YD/T 950
- GR 1089 Inter-building

Electrical Characteristics

| Part Number | Marking | V_{DRM} @ $I_{DRM} = 5\mu A$ | V_S @ $100V/\mu s$ | I_H | I_S | I_T | V_T @ $I_T = 2.2 A$ | Capacitance @ 1MHz, 2V bias | |
|-------------|---------|-----------------------------------|-------------------------|--------|--------|--------|--------------------------|--------------------------------|--------|
| | | V min | V max | mA min | mA max | A max | V max | pF min | pF max |
| P1500MEL | P1500ME | 140 | 180 | 50 | 800 | 2.2/25 | 4 | 400 | 650 |
| P1900MEL | P1900ME | 155 | 220 | 50 | 800 | 2.2/25 | 4 | 400 | 650 |
| P2300MEL | P2300ME | 180 | 260 | 50 | 800 | 2.2/25 | 4 | 350 | 600 |
| P2600MEL | P2600ME | 220 | 300 | 50 | 800 | 2.2/25 | 4 | 300 | 600 |
| P3100MEL | P3100ME | 275 | 350 | 50 | 800 | 2.2/25 | 4 | 300 | 550 |
| P3500MEL | P3500ME | 320 | 400 | 50 | 800 | 2.2/25 | 4 | 300 | 500 |
| P3800MEL | P3800ME | 350 | 430 | 50 | 800 | 2.2/25 | 4 | 300 | 500 |
| P4800MEL | P4800ME | 450 | 600 | 20 | 800 | 2.2/25 | 4 | 300 | 500 |

Notes:
 1. Absolute maximum ratings measured at $T_c = 25^\circ C$ (unless otherwise noted).
 2. Components are bi-directional (unless otherwise noted).
 3. I_T is a free air rating and heat sink is at 25A

Surge Ratings

| Series | I _{PP} | | | I _{TSM} / 60 Hz | di/dt |
|--------|--|--|--|--------------------------|-------|
| | 1.2/50 ¹ 8/20 ² | 10/350 ¹ 1.2/50 ² | 10/1000 ¹ 10/1000 ² | | |
| | A min | A min | A min | | |
| E | 5000 ³ | 1500 | 1100 | 400 | 630 |

Notes:

1. Voltage waveform in μs
2. Current waveform in μs
3. For surge rating of P3800MEL, it is minimum 4kA and typical 5kA @8/20 μs .

- Peak pulse current rating (I_{PP}) is repetitive and guaranteed for the life of the product.
 - The component must initially be in thermal equilibrium with $-40^\circ\text{C} \leq T_J \leq +150^\circ\text{C}$

Thermal Conditions

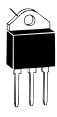
| Package | Symbol | Parameter | Value | Unit |
|--|--------------------|---|-------------|------|
|  TO-218 | T _{JO} | Operating Junction Temperature Range | -40 to +150 | °C |
| | T _S | Storage Temperature Range | -65 to +150 | °C |
| | T _C | Maximum Case Temperature | 100 | °C |
| | R _{θJC} * | Thermal Resistance: Junction to Case | 1.7 | °C/W |
| | R _{θJA} | Thermal Resistance: Junction to Ambient | 56 | °C/W |

*R_{θJC} rating assumes the use of a heat sink and on state mode for extended time at 25 A, with average power dissipation of 29.125 W.

V-I Characteristics

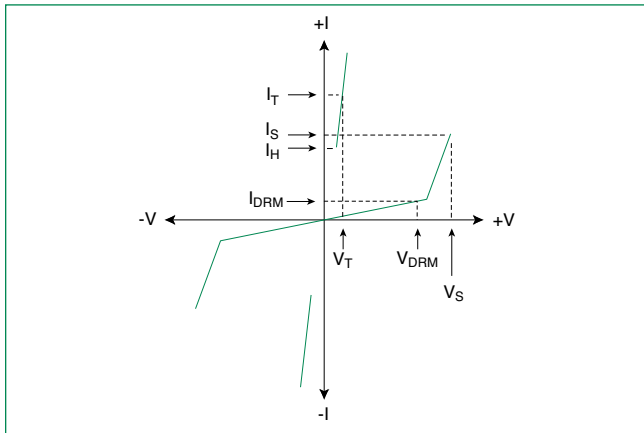

t_r x t_d Pulse Waveform

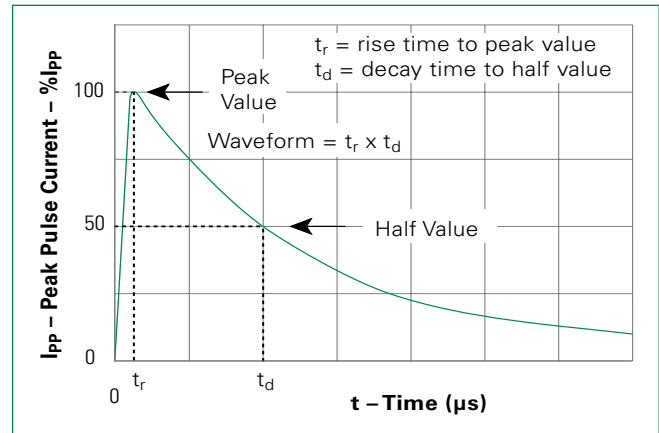

Normalized V_S Change vs. Junction Temperature

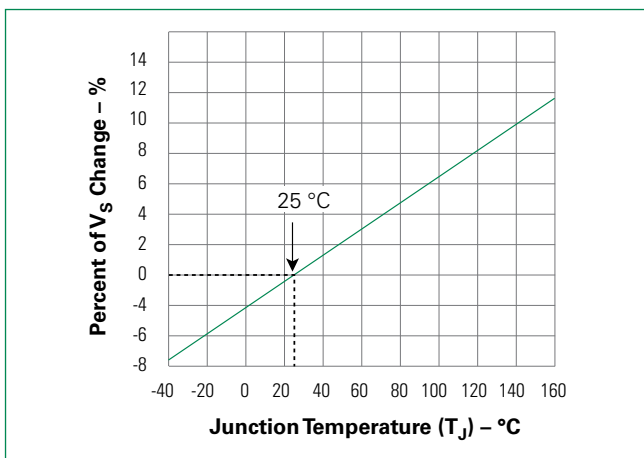

Normalized DC Holding Current vs. Case Temperature

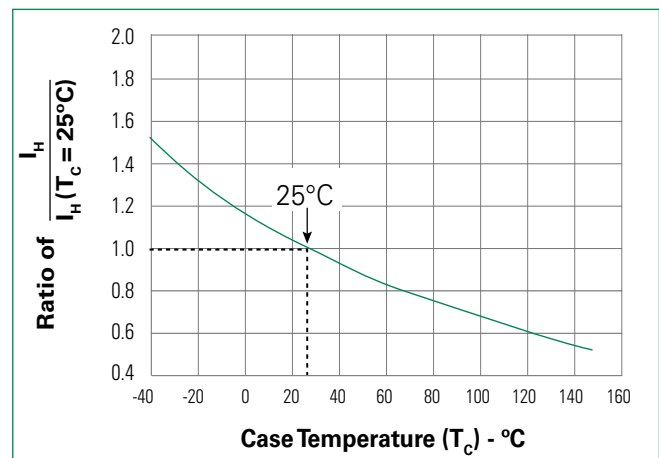

Soldering Parameters

| | | |
|--|------------------------------------|------------------|
| Reflow Condition | | Pb-Free assembly |
| Pre Heat | - Temperature Min ($T_{s(min)}$) | +150°C |
| | - Temperature Max ($T_{s(max)}$) | +200°C |
| | - Time (Min to Max) (t_s) | 60-180 secs. |
| Average ramp up rate (Liquidus Temp (T_L) to peak) | | 3°C/sec. Max. |
| $T_{s(max)}$ to T_L - Ramp-up Rate | | 3°C/sec. Max. |
| Reflow | - Temperature (T_L) (Liquidus) | +217°C |
| | - Temperature (t_l) | 60-150 secs. |
| Peak Temp (T_p) | | +260(+0/-5)°C |
| Time within 5°C of actual Peak Temp (t_p) | | 30 secs. Max. |
| Ramp-down Rate | | 6°C/sec. Max. |
| Time 25°C to Peak Temp (T_p) | | 8 min. Max. |
| Do not exceed | | +260°C |

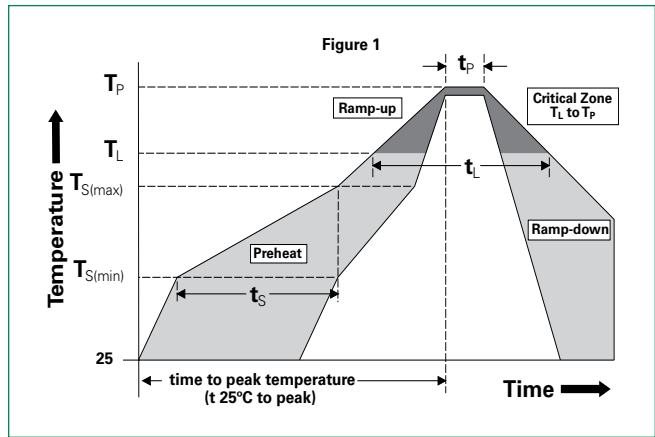

Physical Specifications

| | |
|------------------------|---|
| Lead Material | Copper Alloy |
| Terminal Finish | 100% Matte-Tin Plated |
| Body Material | UL recognized epoxy meeting flammability classification V-0 |

Environmental Specifications

| | |
|---|---|
| High Temp Voltage Blocking | 80% Rated V_{DRM} (V_{AC} Peak) +125°C or +150°C, 504 or 1008 hrs. MIL-STD-750 (Method 1040) JEDEC, JESD22-A-101 |
| Temp Cycling | -65°C to +150°C, 15 min. dwell, 10 up to 100 cycles. MIL-STD-750 (Method 1051) EIA/JEDEC, JESD22-A104 |
| Biased Temp & Humidity | 52 V_{DC} (+85°C) 85%RH, 504 up to 1008 hrs. EIA/JEDEC, JESD22-A-101 |
| High Temp Storage | +150°C 1008 hrs. MIL-STD-750 (Method 1031) JEDEC, JESD22-A-101 |
| Low Temp Storage | -65°C, 1008 hrs. |
| Thermal Shock | 0°C to +100°C, 5 min. dwell, 10 sec. transfer, 10 cycles. MIL-STD-750 (Method 1056) JEDEC, JESD22-A-106 |
| Autoclave (Pressure Cooker Test) | +121°C, 100%RH, 2atm, 24 up to 168 hrs. EIA/JEDEC, JESD22-A-102 |
| Resistance to Solder Heat | +260°C, 30 secs. MIL-STD-750 (Method 2031) |
| Moisture Sensitivity Level | 85%RH, +85°C, 168 hrs., 3 reflow cycles (+260°C Peak). JEDEC-J-STD-020, Level 1 |

Wave Solder (THD) Parameters and Lead-Free Requirements

| Reflow Parameter | Lead-Free Requirement |
|----------------------------------|-----------------------|
| Prehead (Depending on Flux Only) | |
| Temperature Min | 150°C |
| Temperature Max | 200°C |
| Time (Min to Max) | 60 - 180 Seconds |
| Solder Pot Temperature | 245 - 265°C (Max) |
| Solder Dwell Time | 2 - 3.5 Seconds |
| Cooling | -6°C/Seconds (Max) |

Part Numbering

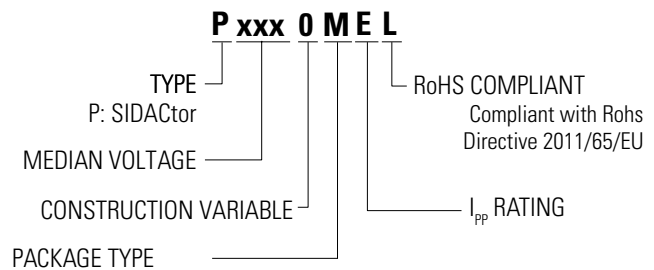

Part Marking

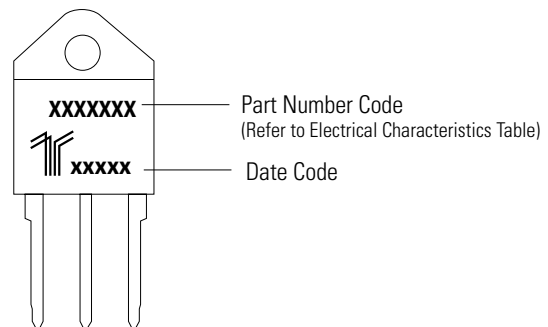

Dimensions — TO-218

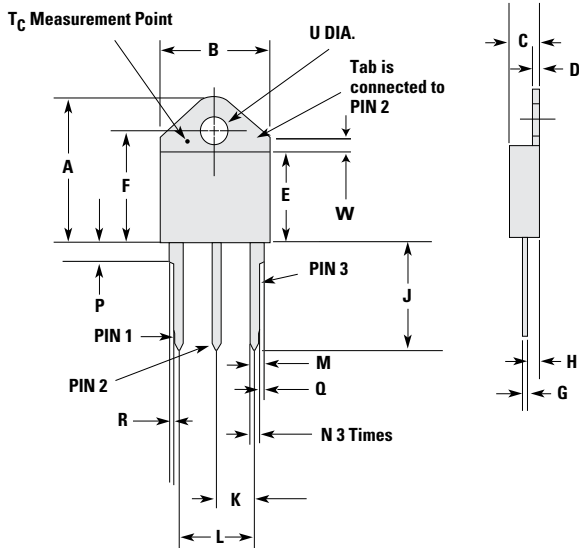

| Dimensions | Inches | | Millimeters | |
|------------|--------|-------|-------------|-------|
| | Min | Max | Min | Max |
| A | 0.810 | 0.835 | 20.57 | 21.21 |
| B | 0.610 | 0.630 | 15.49 | 16.00 |
| C | 0.178 | 0.188 | 4.52 | 4.78 |
| D | 0.055 | 0.070 | 1.40 | 1.78 |
| E | 0.487 | 0.497 | 12.37 | 12.62 |
| F | 0.635 | 0.655 | 16.13 | 16.64 |
| G | 0.022 | 0.029 | 0.56 | 0.74 |
| H | 0.075 | 0.095 | 1.91 | 2.41 |
| J | 0.575 | 0.625 | 14.61 | 15.88 |
| K | 0.211 | 0.219 | 5.36 | 5.56 |
| L | 0.422 | 0.437 | 10.72 | 11.10 |
| M | 0.058 | 0.068 | 1.47 | 1.73 |
| N | 0.045 | 0.055 | 1.14 | 1.40 |
| P | 0.095 | 0.115 | 2.41 | 2.92 |
| R | 0.008 | 0.016 | 0.20 | 0.41 |
| U | 0.161 | 0.165 | 4.1 | 4.2 |
| W | 0.085 | 0.095 | 2.17 | 2.42 |

- Notes:**
- Mold flash shall not exceed 0.13 mm per side.
 - Maximum torque to be applied to mounting tab is 8 in-lbs. (0.904 Nm).
 - Pin 3 has no connection.
 - Tab is non-isolated (connects to middle pin).

Packing Options

| Package Type | Description | Packing Options Quantity | Added Suffix | Industry Standard |
|--------------|-----------------------|-----------------------------------|--------------|-------------------|
| M | TO-218 (ME) Tube Pack | 250(25 per tube/10 tubes per box) | N/A | N/A |

Tube Pack Specification — TO-218

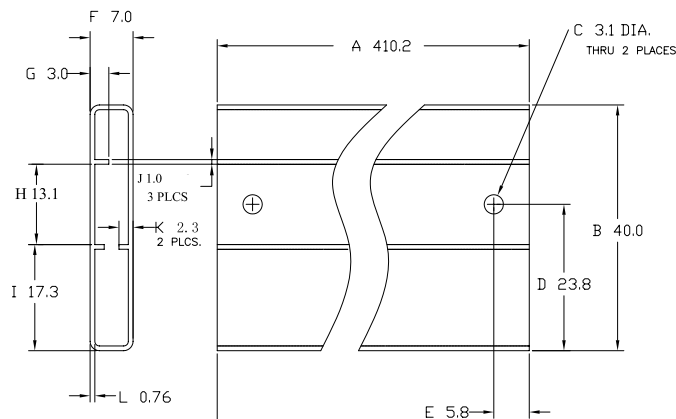

Disclaimer Notice - Information furnished is believed to be accurate and reliable. However, users should independently evaluate the suitability of and test each product selected for their own applications. Littelfuse products are not designed for, and may not be used in, all applications. Read complete Disclaimer Notice at <http://www.littelfuse.com/disclaimer-electronics>.

Компания «Океан Электроники» предлагает заключение долгосрочных отношений при поставках импортных электронных компонентов на взаимовыгодных условиях!

Наши преимущества:

- Поставка оригинальных импортных электронных компонентов напрямую с производств Америки, Европы и Азии, а так же с крупнейших складов мира;
- Широкая линейка поставок активных и пассивных импортных электронных компонентов (более 30 млн. наименований);
- Поставка сложных, дефицитных, либо снятых с производства позиций;
- Оперативные сроки поставки под заказ (от 5 рабочих дней);
- Экспресс доставка в любую точку России;
- Помощь Конструкторского Отдела и консультации квалифицированных инженеров;
- Техническая поддержка проекта, помощь в подборе аналогов, поставка прототипов;
- Поставка электронных компонентов под контролем ВП;
- Система менеджмента качества сертифицирована по Международному стандарту ISO 9001;
- При необходимости вся продукция военного и аэрокосмического назначения проходит испытания и сертификацию в лаборатории (по согласованию с заказчиком);
- Поставка специализированных компонентов военного и аэрокосмического уровня качества (Xilinx, Altera, Analog Devices, Intersil, Interpoint, Microsemi, Actel, Aeroflex, Peregrine, VPT, Syfer, Eurofarad, Texas Instruments, MS Kennedy, Miteq, Cobham, E2V, MA-COM, Hittite, Mini-Circuits, General Dynamics и др.);

Компания «Океан Электроники» является официальным дистрибьютором и эксклюзивным представителем в России одного из крупнейших производителей разъемов военного и аэрокосмического назначения «JONHON», а так же официальным дистрибьютором и эксклюзивным представителем в России производителя высокотехнологичных и надежных решений для передачи СВЧ сигналов «FORSTAR».



JONHON

«JONHON» (основан в 1970 г.)

Разъемы специального, военного и аэрокосмического назначения:

(Применяются в военной, авиационной, аэрокосмической, морской, железнодорожной, горно- и нефтедобывающей отраслях промышленности)

«FORSTAR» (основан в 1998 г.)

ВЧ соединители, коаксиальные кабели, кабельные сборки и микроволновые компоненты:

(Применяются в телекоммуникациях гражданского и специального назначения, в средствах связи, РЛС, а так же военной, авиационной и аэрокосмической отраслях промышленности).



Телефон: 8 (812) 309-75-97 (многоканальный)

Факс: 8 (812) 320-03-32

Электронная почта: ocean@oceanchips.ru

Web: <http://oceanchips.ru/>

Адрес: 198099, г. Санкт-Петербург, ул. Калинина, д. 2, корп. 4, лит. А