

High Speed Infrared Emitting Diode, 850 nm, GaAlAs, DH

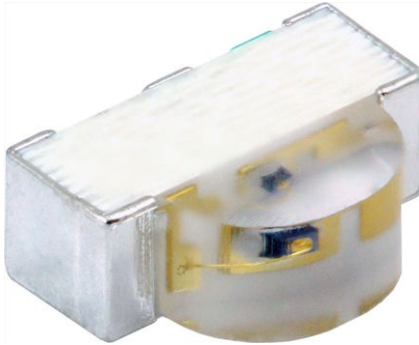

DESCRIPTION

VSMG10850 is an infrared, 850 nm side looking emitting diode in GaAlAs double hetero (DH) technology with high radiant power and high speed, molded in clear, untinted plastic package for surface mounting (SMD).

FEATURES

- Package type: Surface mount
- Package form: Side view
- Dimensions (L x W x H in mm): 3 x 2 x 1
- Peak wavelength: $\lambda_p = 850$ nm
- High reliability
- High radiant power
- High radiant intensity
- High speed
- Angle of half sensitivity: $\phi = \pm 75^\circ$
- Low forward voltage
- Package matches with detector VEMD10940F
- Floor life: 168 h, MSL 3, acc. J-STD-020
- Lead (Pb)-free reflow soldering
- Material categorization: For definitions of compliance please see www.vishay.com/doc?99912



APPLICATIONS

- IR touch panel
- High power emitter for low space applications
- High performance transmissive or reflective sensors

PRODUCT SUMMARY				
COMPONENT	I_e (mW/sr), 20 mA	ϕ (deg)	λ_p (nm)	t_r (ns)
VSMG10850	1	± 75	850	15

Note

- Test conditions see table “Basic Characteristics”

ORDERING INFORMATION			
ORDERING CODE	PACKAGING	REMARKS	PACKAGE FORM
VSMG10850	Tape and reel	MOQ: 3000 pcs, 3000 pcs/reel	side view

Note

- MOQ: minimum order quantity

ABSOLUTE MAXIMUM RATINGS ($T_{amb} = 25^\circ\text{C}$, unless otherwise specified)				
PARAMETER	TEST CONDITION	SYMBOL	VALUE	UNIT
Reverse voltage		V_R	5	V
Forward current		I_F	65	mA
Peak forward current	$t_p/T = 0.5$, $t_p = 100 \mu\text{s}$	I_{FM}	130	mA
Surge forward current	$t_p = 100 \mu\text{s}$	I_{FSM}	500	mA
Power dissipation		P_V	110	mW
Junction temperature		T_j	100	$^\circ\text{C}$
Operating temperature range		T_{amb}	- 40 to + 85	$^\circ\text{C}$
Storage temperature range		T_{stg}	- 40 to + 100	$^\circ\text{C}$
Soldering temperature	according to fig. 9, J-STD-020	T_{sd}	260	$^\circ\text{C}$
Thermal resistance junction/ambient	J-STD-051, leads 7 mm, soldered on PCB	R_{thJA}	450	K/W

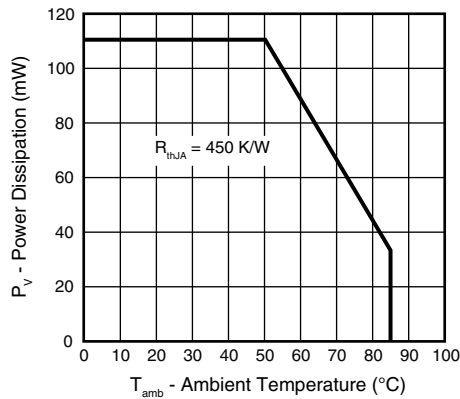

Fig. 1 - Power Dissipation Limit vs. Ambient Temperature

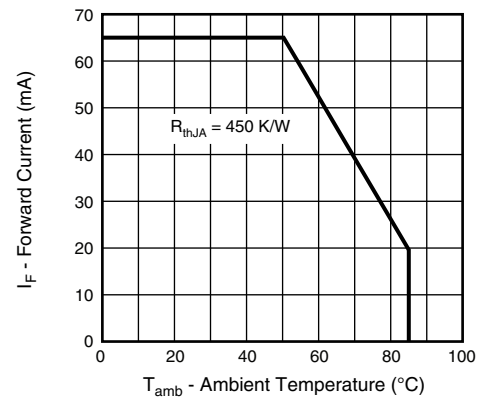

Fig. 2 - Forward Current Limit vs. Ambient Temperature

BASIC CHARACTERISTICS (T _{amb} = 25 °C, unless otherwise specified)						
PARAMETER	TEST CONDITION	SYMBOL	MIN.	TYP.	MAX.	UNIT
Forward voltage	I _F = 20 mA, t _p = 20 ms	V _F	1.1	1.4	1.65	V
	I _F = 65 mA, t _p = 20 ms	V _F		1.45		V
	I _F = 500 mA, t _p = 100 μs	V _F		1.9		V
Temperature coefficient of V _F	I _F = 1 mA	TK _{V_F}		- 1.8		mV/K
Reverse current	V _R = 5 V	I _R			10	μA
Junction capacitance	V _R = 0 V, f = 1 MHz, E = 0 mW/cm ²	C _J		45		pF
Radiant intensity	I _F = 20 mA, t _p = 20 ms	I _e	0.6	1	1.8	mW/sr
	I _F = 65 mA, t _p = 20 ms	I _e		3.25		mW/sr
	I _F = 500 mA, t _p = 100 μs	I _e		24		mW/sr
Radiant power	I _F = 100 mA, t _p = 20 ms	φ _e		40		mW
Temperature coefficient of radiant power	I _F = 1 mA	TK _{φ_e}		- 1.1		%/K
Angle of half intensity - horizontal		φ _h		± 77.5		deg
Angle of half intensity - vertical		φ _v		± 72.5		deg
Peak wavelength	I _F = 30 mA	λ _p		850		nm
Spectral bandwidth	I _F = 30 mA	Δλ		40		nm
Temperature coefficient of λ _p	I _F = 30 mA	TK _{λ_p}		0.25		nm
Rise time	I _F = 100 mA, 20 % to 80 %	t _r		20		ns
Fall time	I _F = 100 mA, 20 % to 80 %	t _f		20		ns

BASIC CHARACTERISTICS ($T_{amb} = 25\text{ }^{\circ}\text{C}$, unless otherwise specified)

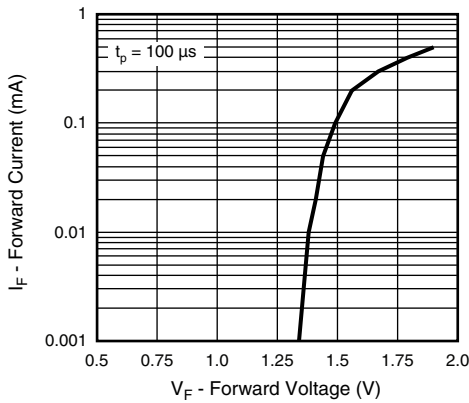

Fig. 3 - Forward Current vs. Forward Voltage

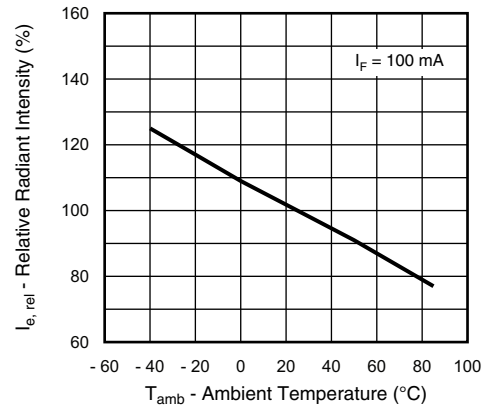

Fig. 6 - Relative Radiant Intensity vs. Ambient Temperature

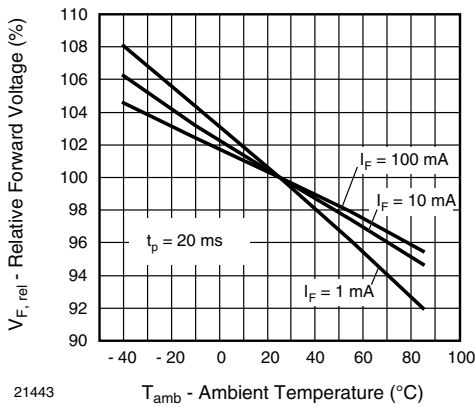

Fig. 4 - Relative Forward Voltage vs. Ambient Temperature

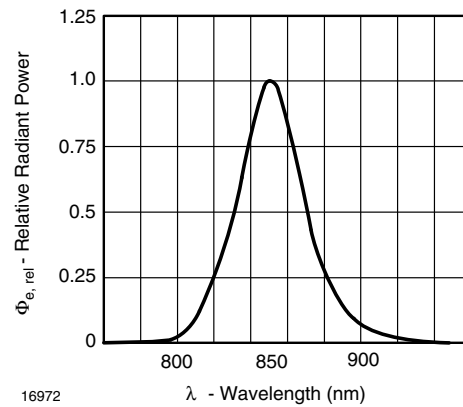

Fig. 7 - Relative Radiant Power vs. Wavelength

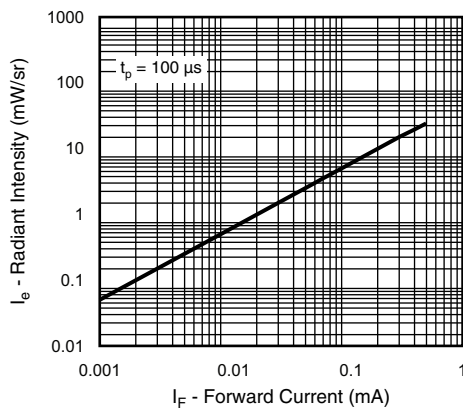

Fig. 5 - Radiant Intensity vs. Forward Current

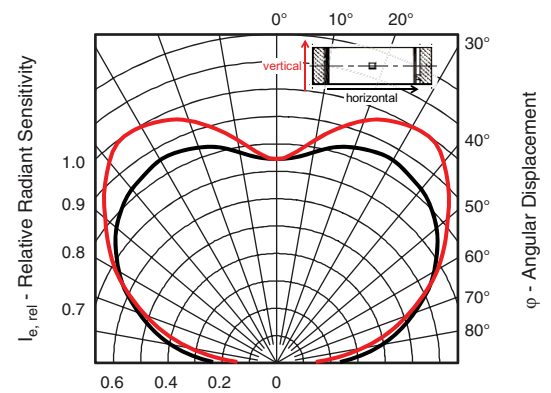

Fig. 8 - Relative Radiant Intensity vs. Angular Displacement

REFLOW SOLDER PROFILE

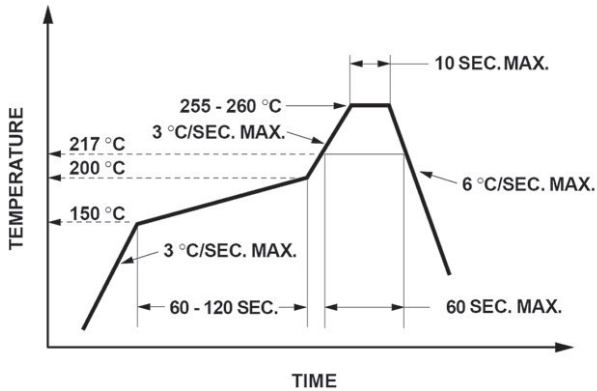

Fig. 9 - Lead (Pb)-free Reflow Solder Profile acc. J-STD-020

DRYPACK

Devices are packed in moisture barrier bags (MBB) to prevent the products from moisture absorption during transportation and storage. Each bag contains a desiccant.

FLOOR LIFE

Time between soldering and removing from MBB must not exceed the time indicated in J-STD-020:

Moisture sensitivity: level 3

Floor life: 168 h

Conditions: $T_{amb} < 30\text{ }^{\circ}\text{C}$, RH < 60 %

DRYING

In case of moisture absorption devices should be baked before soldering. Conditions see J-STD-020 or label. Devices taped on reel dry using recommended conditions 192 h at 40 °C (+ 5 °C), RH < 5 %.

PACKAGE DIMENSIONS in millimeters

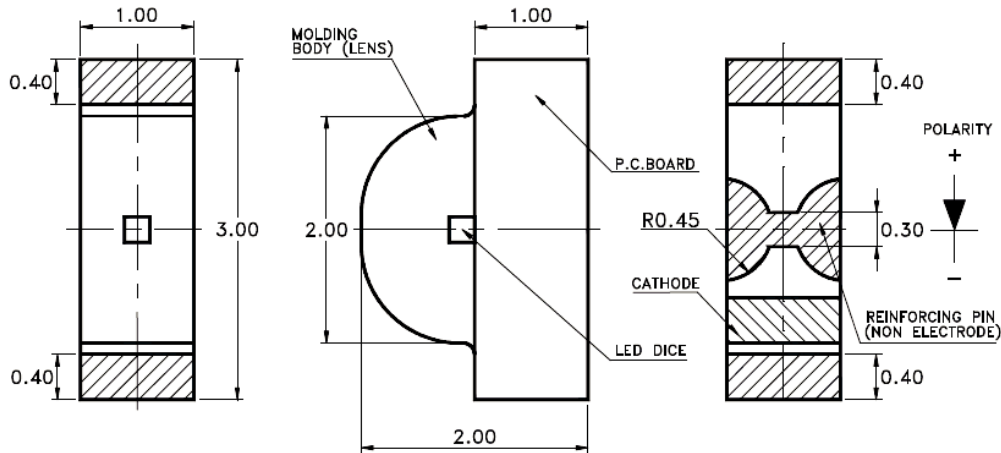

Recommended Solder Pad Footprint

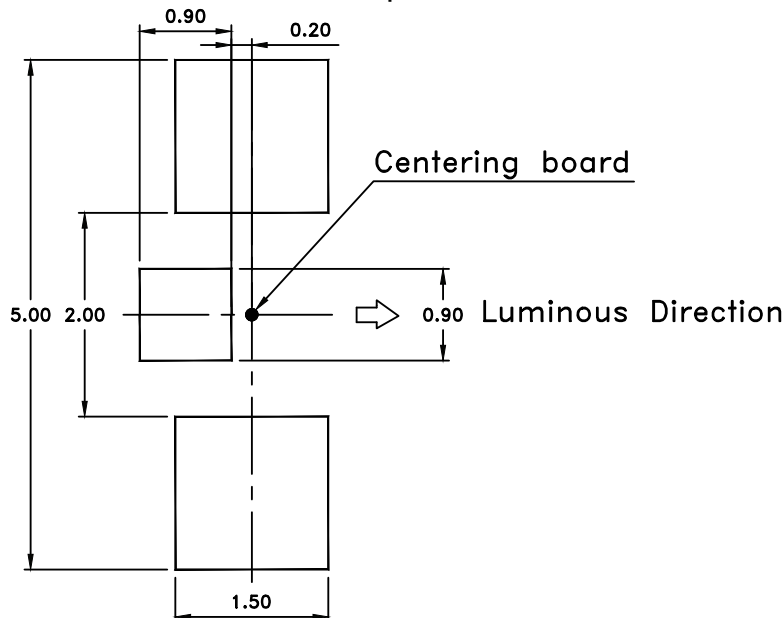

22701

BLISTER TAPE DIMENSIONS in millimeters

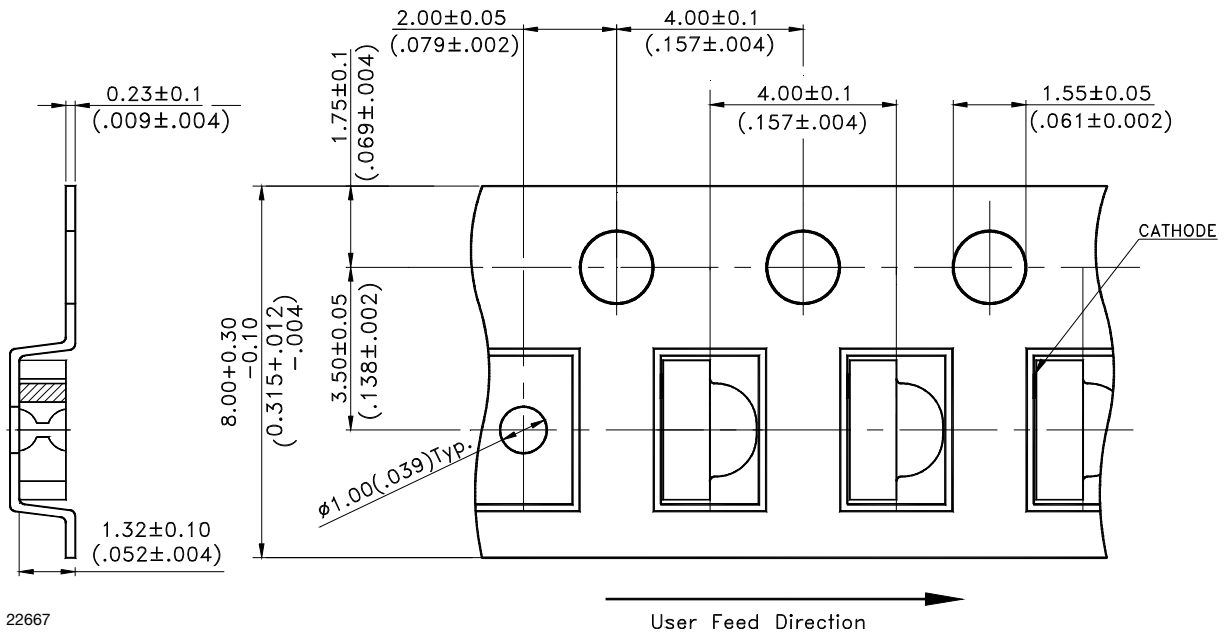

REEL DIMENSIONS in millimeters

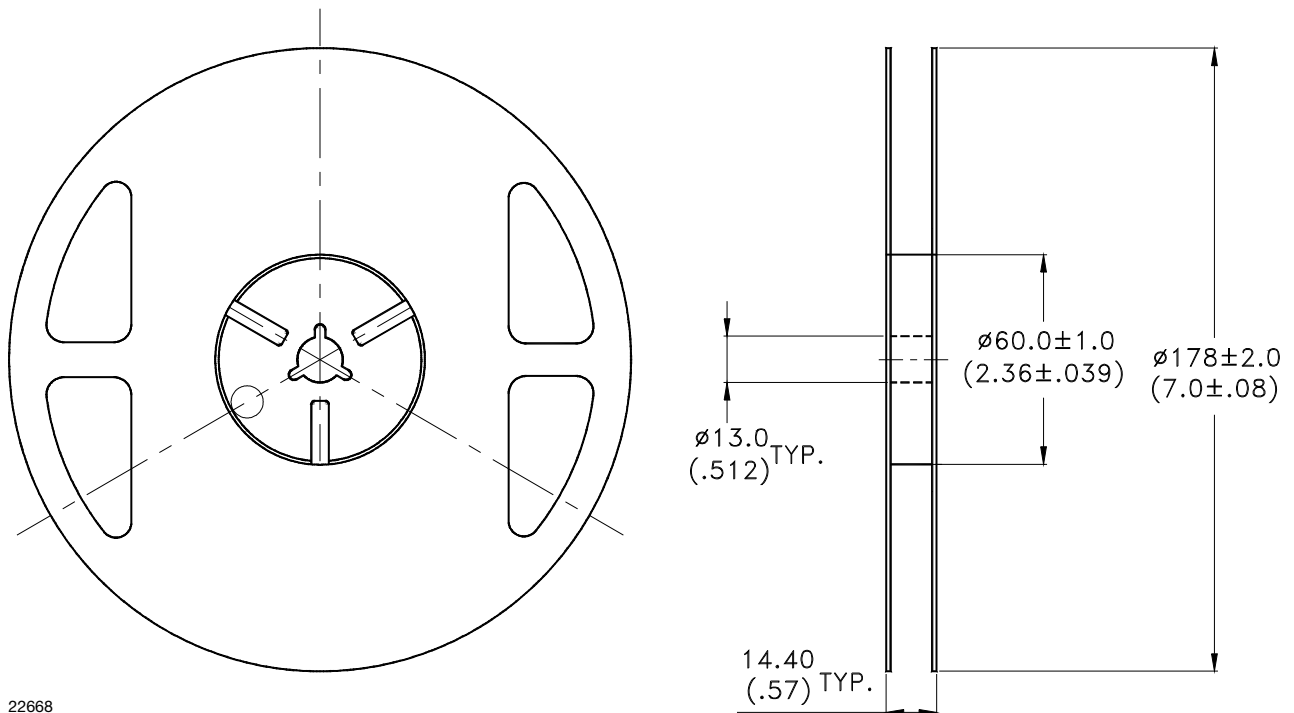



Disclaimer

ALL PRODUCT, PRODUCT SPECIFICATIONS AND DATA ARE SUBJECT TO CHANGE WITHOUT NOTICE TO IMPROVE RELIABILITY, FUNCTION OR DESIGN OR OTHERWISE.

Vishay Intertechnology, Inc., its affiliates, agents, and employees, and all persons acting on its or their behalf (collectively, "Vishay"), disclaim any and all liability for any errors, inaccuracies or incompleteness contained in any datasheet or in any other disclosure relating to any product.

Vishay makes no warranty, representation or guarantee regarding the suitability of the products for any particular purpose or the continuing production of any product. To the maximum extent permitted by applicable law, Vishay disclaims (i) any and all liability arising out of the application or use of any product, (ii) any and all liability, including without limitation special, consequential or incidental damages, and (iii) any and all implied warranties, including warranties of fitness for particular purpose, non-infringement and merchantability.

Statements regarding the suitability of products for certain types of applications are based on Vishay's knowledge of typical requirements that are often placed on Vishay products in generic applications. Such statements are not binding statements about the suitability of products for a particular application. It is the customer's responsibility to validate that a particular product with the properties described in the product specification is suitable for use in a particular application. Parameters provided in datasheets and/or specifications may vary in different applications and performance may vary over time. All operating parameters, including typical parameters, must be validated for each customer application by the customer's technical experts. Product specifications do not expand or otherwise modify Vishay's terms and conditions of purchase, including but not limited to the warranty expressed therein.

Except as expressly indicated in writing, Vishay products are not designed for use in medical, life-saving, or life-sustaining applications or for any other application in which the failure of the Vishay product could result in personal injury or death. Customers using or selling Vishay products not expressly indicated for use in such applications do so at their own risk. Please contact authorized Vishay personnel to obtain written terms and conditions regarding products designed for such applications.

No license, express or implied, by estoppel or otherwise, to any intellectual property rights is granted by this document or by any conduct of Vishay. Product names and markings noted herein may be trademarks of their respective owners.

Material Category Policy

Vishay Intertechnology, Inc. hereby certifies that all its products that are identified as RoHS-Compliant fulfill the definitions and restrictions defined under Directive 2011/65/EU of The European Parliament and of the Council of June 8, 2011 on the restriction of the use of certain hazardous substances in electrical and electronic equipment (EEE) - recast, unless otherwise specified as non-compliant.

Please note that some Vishay documentation may still make reference to RoHS Directive 2002/95/EC. We confirm that all the products identified as being compliant to Directive 2002/95/EC conform to Directive 2011/65/EU.

Vishay Intertechnology, Inc. hereby certifies that all its products that are identified as Halogen-Free follow Halogen-Free requirements as per JEDEC JS709A standards. Please note that some Vishay documentation may still make reference to the IEC 61249-2-21 definition. We confirm that all the products identified as being compliant to IEC 61249-2-21 conform to JEDEC JS709A standards.

Компания «Океан Электроники» предлагает заключение долгосрочных отношений при поставках импортных электронных компонентов на взаимовыгодных условиях!

Наши преимущества:

- Поставка оригинальных импортных электронных компонентов напрямую с производств Америки, Европы и Азии, а так же с крупнейших складов мира;
- Широкая линейка поставок активных и пассивных импортных электронных компонентов (более 30 млн. наименований);
- Поставка сложных, дефицитных, либо снятых с производства позиций;
- Оперативные сроки поставки под заказ (от 5 рабочих дней);
- Экспресс доставка в любую точку России;
- Помощь Конструкторского Отдела и консультации квалифицированных инженеров;
- Техническая поддержка проекта, помощь в подборе аналогов, поставка прототипов;
- Поставка электронных компонентов под контролем ВП;
- Система менеджмента качества сертифицирована по Международному стандарту ISO 9001;
- При необходимости вся продукция военного и аэрокосмического назначения проходит испытания и сертификацию в лаборатории (по согласованию с заказчиком);
- Поставка специализированных компонентов военного и аэрокосмического уровня качества (Xilinx, Altera, Analog Devices, Intersil, Interpoint, Microsemi, Actel, Aeroflex, Peregrine, VPT, Syfer, Eurofarad, Texas Instruments, MS Kennedy, Miteq, Cobham, E2V, MA-COM, Hittite, Mini-Circuits, General Dynamics и др.);

Компания «Океан Электроники» является официальным дистрибьютором и эксклюзивным представителем в России одного из крупнейших производителей разъемов военного и аэрокосмического назначения «**JONHON**», а так же официальным дистрибьютором и эксклюзивным представителем в России производителя высокотехнологичных и надежных решений для передачи СВЧ сигналов «**FORSTAR**».



JONHON

«**JONHON**» (основан в 1970 г.)

Разъемы специального, военного и аэрокосмического назначения:

(Применяются в военной, авиационной, аэрокосмической, морской, железнодорожной, горно- и нефтедобывающей отраслях промышленности)

«**FORSTAR**» (основан в 1998 г.)

ВЧ соединители, коаксиальные кабели,
кабельные сборки и микроволновые компоненты:

(Применяются в телекоммуникациях гражданского и специального назначения, в средствах связи, РЛС, а так же военной, авиационной и аэрокосмической отраслях промышленности).



Телефон: 8 (812) 309-75-97 (многоканальный)

Факс: 8 (812) 320-03-32

Электронная почта: ocean@oceanchips.ru

Web: <http://oceanchips.ru/>

Адрес: 198099, г. Санкт-Петербург, ул. Калинина, д. 2, корп. 4, лит. А