

## Synchronous Step-down DC/DC Converter with VD and VR

NO.EA-156-121225

### OUTLINE

The RP901xxxx is a CMOS-based current mode PWM control synchronous step-down DC/DC converter with a voltage detector (VD) and an LDO regulator (VR).

Each of Step-down DC/DC converters is composed of an oscillator, a voltage reference unit, an error amplifier, a switching control circuit, a soft-start circuit, a protection circuit, a UVLO circuit, a switching transistor. Due to the switching elements are built in and synchronous control, a high efficiency step-down DC/DC converter can be made with an inductor and capacitors. To realize high efficiency at light load, automatic PWM/VFM alternative mode can be selected other than the PWM fixed control mode.

As protection circuits, a current limit circuit which limits Lx peak current cycle by cycle and a hiccup mode protection circuit which works if the load current over the limit continues for a certain time<sup>\*1</sup> are built in. The output voltage can be preset with 0.05V step in the factory due to the built-in feed back resistance, and the tolerance is  $\pm 2\%$ . Since the package is DFN (PLP) 2527-10, high density mounting on board is possible.

Built-in LDO regulator (VR) is composed of a voltage reference unit, a voltage detecting resistor-network, an error amplifier, a short current limit circuit, and a driver transistor. After the soft-start time of the DC/DC converter is over and a specified delay time, LDO starts up. The sequence function is fixed internally<sup>\*2</sup>.

Built-in voltage detector (VD) supervises the input voltage or the output of the VR (The reset function works for UVLO and over-current of the DC/DC converter). The option is preset in the factory. The output type is N-channel open drain. The released delay time is built-in, typ.50ms.

If the junction temperature of the IC is over the limit, the system is reset by the built-in thermal shut-down circuit.

\*1) A version: As soon as the load current is over the limit, the system restarts by the protection.

\*2) C, D versions: No sequence function

### FEATURES

- Input Voltage Range..... 4.5V to 5.5V
- Supply Current..... Typ. 460 $\mu$ A (at PWM mode)  
Typ. 170 $\mu$ A (at light load applied to B, C, D versions)

#### Step-down DC/DC Converter

- Output Voltage Range ..... 1.2V to 1.8V, preset is possible by user's request
- Output Voltage Tolerance .....  $\pm 2\%$
- Oscillator Frequency..... Typ. 1.2MHz
- Built-in driver ON resistance..... Typ. P-channel 0.25 $\Omega$ , N-channel 0.25 $\Omega$  (at  $V_{IN}=5V$ )
- Soft-start function..... Typ. 1ms
- Lx peak current limit function..... Typ. 1.4A (D version: 1.5A)
- Output Current..... Min. 800mA (D version: 900mA)
- Protection Delay Time ..... Typ. 0.1ms (applied to B, C, D versions)
- UVLO function ..... Typ. 3.5V
- Chip enable function..... "H" active

**LDO Regulator**

- Output Voltage Range ..... 2.5V to 3.3V, preset is possible by user's request
- Output Voltage Tolerance .....  $\pm 1.0\%$
- Output Current ..... Min. 600mA
- Start-up delay time ..... Typ. 2ms (applied to A, B versions)
- Auto-Discharge function at turning off ..... Discharge resistance Typ.50 $\Omega$  (at  $V_{IN}=5V$ )

**VD**

- Voltage Detector Threshold Range ..... 2.0V to 3.0V, preset is possible by user's request  
(A version: VR output voltage is supervised),  
3.0V to 5.0V, preset is possible by user's request  
(B, C, D versions: Input voltage is supervised)
- Released Delay Time ..... Typ.50ms
- Thermal shutdown circuit ..... Detecting Temperature: Typ. 165°C,  
Released temperature: Typ. 110°C
- Package ..... DFN(PLP)2527-10
- External Components .....  $C_{IN}=10.0\mu F$ ,  $C_{OUT1}=10.0\mu F$ ,  $L=4.7\mu H$  (DC/DC),  
 $C_{OUT2}=2.2\mu F$ (VR)

**APPLICATION**

- Optical Disk Equipment

# BLOCK DIAGRAMS

## A version

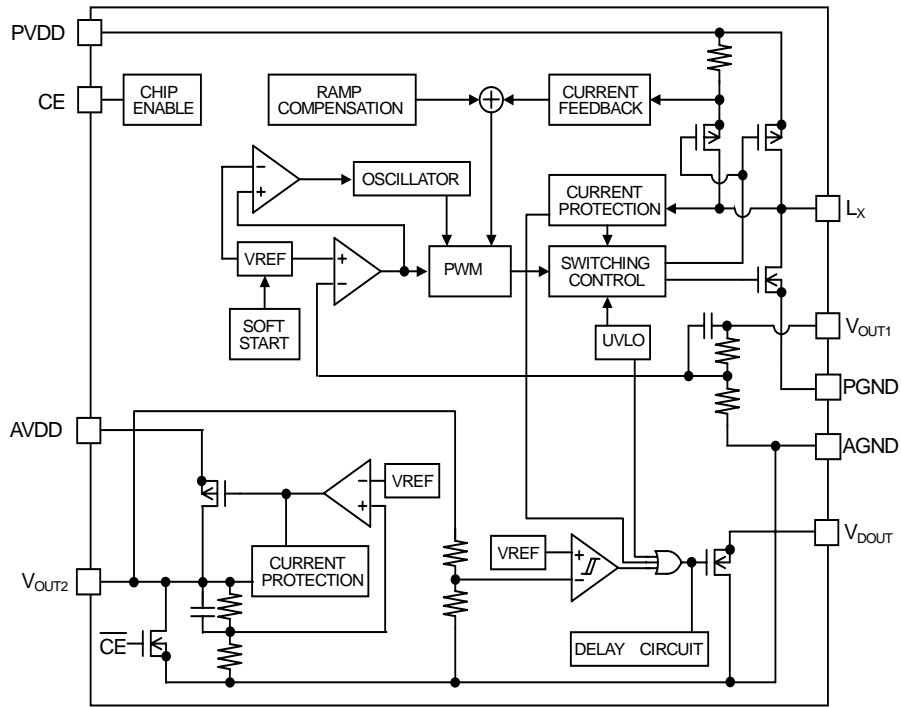

## B/C/D version

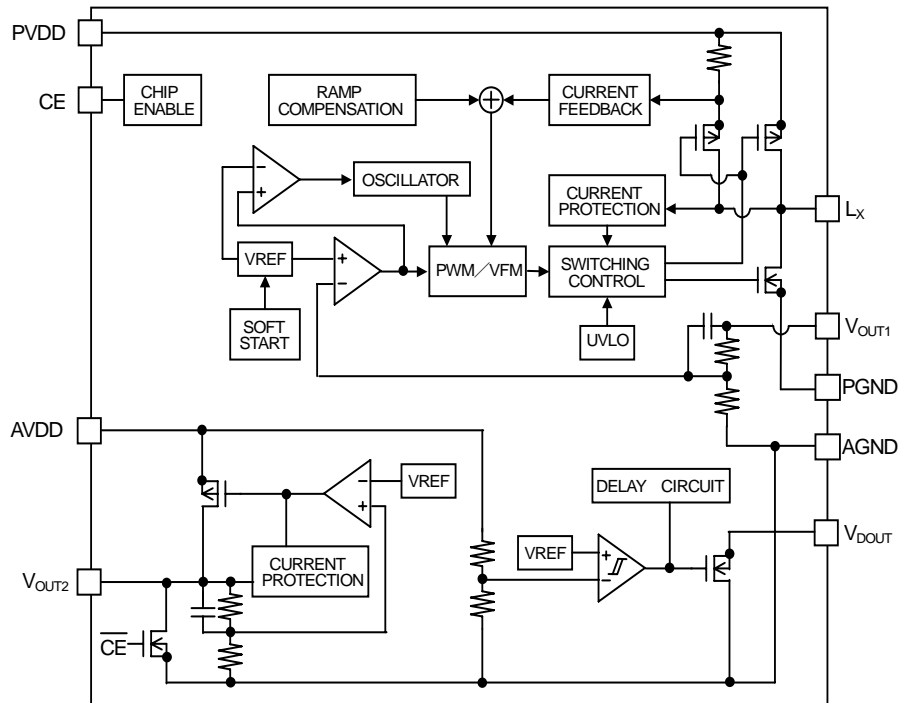

## SELECTION GUIDE

In the RP901 series, the output voltage combination and function can be designated.

The selection can be made by the alphanumeric serial number as the next example.

Product Code	Package	Units/ 1 reel	Pb free	Halogen free
RP901Kxxx*-TR	DFN(PLP)2527-10	5,000pcs	Yes	Yes

xxx: Serial number to describe the voltage combination of DC/DC converter, voltage regulator, and voltage detector.

\*: Function version

A version: DC/DC control type is PWM-fixed, without protection delay time, output current Min. 800mA, VR has start-up delay time to make a sequence. VD supervises the output of VR (Reset is output at UVLO and over current of DC/DC)

B version: DC/DC control type is PWM/VFM automatic mode shift, with protection delay time, output current Min. 800mA, VR has start-up delay time to make a sequence. VD supervises the input voltage.

C version: DC/DC control type is PWM/VFM automatic mode shift, with protection delay time, output current Min. 800mA, VR: without delay time to make a sequence, VD supervises the input voltage.

D version: DC/DC control type is PWM/VFM automatic mode shift, with protection delay time, output current Min. 900mA, VR: without delay time to make a sequence, VD supervises the input voltage.

## PIN CONFIGURATION

### DFN(PLP)2527-10

Mark Side

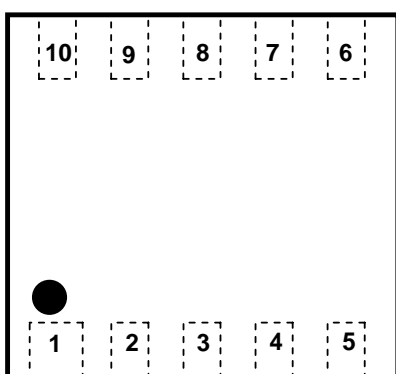

Bottom Side

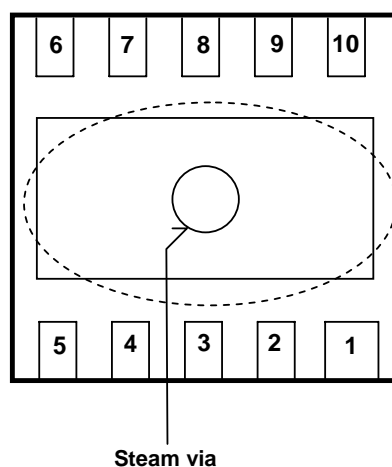

## PIN DESCRIPTIONS

Pin No.	Symbol	Description
1	CE	Chip Enable Pin ("H" active)
2	V <sub>DOUT</sub>	VD Output Pin (N-channel open drain output)
3	AGND	Analog Ground Pin
4	PGND	Power Ground Pin
5	L <sub>X</sub>	DC/DC Switching Pin
6	PVDD	Power Supply Input Pin
7	NC	No connection
8	V <sub>OUT1</sub>	DC/DC Output Pin
9	AVDD	Analog Power Supply Input Pin
10	V <sub>OUT2</sub>	VR Output Pin

The backside of the package tab is connected to the substrate of the IC (GND). Connect to GND pin (Recommendation), or solder the tab and left open electrically.  
Make short 3pin and 4pin, and make short 6pin and 9pin.

## ABSOLUTE MAXIMUM RATINGS

(GND=0V)

Symbol	Item	Rating	Unit	
V <sub>IN</sub>	PVDD Pin Voltage AVDD Pin Voltage	6.5	V	
V <sub>CE</sub>	CE Pin Voltage	-0.3 to 6.5	V	
V <sub>LX</sub>	L <sub>X</sub> Pin Voltage	-0.3 to V <sub>IN</sub> + 0.3	V	
V <sub>OUT1</sub>	V <sub>OUT1</sub> Pin Voltage	-0.3 to V <sub>IN</sub> + 0.3	V	
V <sub>OUT2</sub>	V <sub>OUT2</sub> Pin Voltage	-0.3 to V <sub>IN</sub> + 0.3	V	
V <sub>DOUT</sub>	V <sub>DOUT</sub> Pin Voltage	-0.3 to 6.5	V	
P <sub>D</sub>	Power Dissipation*	(1)	1750 (Ta=25°C, Tjmax=150°C)	mW
		(2)	1138 (Ta=25°C, Tjmax=150°C)	
T <sub>a</sub>	Operating Temperature	-40 to +85	°C	
T <sub>stg</sub>	Storage Temperature	-55 to +125	°C	

\* For more information about Power Dissipation and Standard Land Pattern, refer to *PACKAGE INFORMATION*.

### ABSOLUTE MAXIMUM RATINGS

Electronic and mechanical stress momentarily exceeded absolute maximum ratings may cause the permanent damages and may degrade the life time and safety for both device and system using the device in the field. The functional operation at or over these absolute maximum ratings is not assured.

### RECOMMENDED OPERATING CONDITIONS (ELECTRICAL CHARACTERISTICS)

All of electronic equipment should be designed that the mounted semiconductor devices operate within the recommended operating conditions. The semiconductor devices cannot operate normally over the recommended operating conditions, even if when they are used over such conditions by momentary electronic noise or surge. And the semiconductor devices may receive serious damage when they continue to operate over the recommended operating conditions.

## ELECTRICAL CHARACTERISTICS

Unless otherwise specified, the measurement is done by an open loop circuit. Unless otherwise specified,  $V_{IN}=V_{CE}=5V$ ,  $AGND=PGND=0V$ .

### RP901xxx

Symbol	Parameter	Conditions	Min.	Typ.	Max.	Unit
$V_{IN}$	Operating Input Voltage		4.5		5.5	V
$I_{SS1}$	Supply Current 1	$V_{IN}=V_{CE}=5.5V$ $V_{OUT1}=V_{SET} \times 0.8$		460		$\mu A$
$I_{SS2}$	Supply Current 2 (applied to B/C/D version)	$V_{IN}=V_{CE}=5.5V$ $V_{OUT1}=V_{SET} \times 1.2$		170		$\mu A$
Istandby	Standby Current	$V_{IN}=5.5V$ $V_{CE}=0V$	A version	1.0	5.0	$\mu A$
			B/C/D version	2.0		
$V_{CEH}$	CE Input Voltage "H"		1.0			V
$V_{CEL}$	CE Input Voltage "L"				0.3	V
$T_{TSD}$	Thermal Shutdown Detector Temperature	Junction Temperature		165		$^{\circ}C$
$T_{TSR}$	Thermal Shutdown Release Temperature	Junction Temperature		110		$^{\circ}C$

### DC/DC SECTION

( $T_a=25^{\circ}C$ )

Symbol	Parameter	Conditions	Min.	Typ.	Max.	Unit
$V_{OUT1}$	Output Voltage 1	$V_{IN}=5V$	-2.0%		+2.0%	V
$\Delta V_{OUT1} / \Delta T_a$	Output Voltage 1 Temperature Coefficient	$-40^{\circ}C \leq T_a \leq 85^{\circ}C$		$\pm 150$		ppm/ $^{\circ}C$
fosc	Oscillator Frequency	$V_{IN}=5V$	-20%	1.2	+20%	MHz
$I_{LXLEAKH}$	$I_{LX}$ leakage Current "H"	$V_{IN}=V_{LX}=5.5V, V_{CE}=0V$	-1.0	0.0	5.0	$\mu A$
$I_{LXLEAKL}$	$I_{LX}$ leakage Current "L"	$V_{IN}=5.5V, V_{CE}=V_{LX}=0V$	-5.0	0.0	1.0	$\mu A$
$R_{ONP}$	P-channel transistor ON resistance	$V_{IN}=5V, I_{LX}=-100mA$		0.25		$\Omega$
$R_{ONN}$	N-channel transistor ON resistance	$V_{IN}=5V, I_{LX}=-100mA$		0.25		$\Omega$
Maxduty	Maximum Duty Cycle		100			%
tstart	Soft-start Time	$V_{IN}=V_{CE}=5V$		1.0		ms
$I_{LXLIM}$	$I_{LX}$ Current Limit	$V_{IN}=V_{CE}=5V$	A/B/C version	1.0	1.4	A
			D version	1.1	1.5	
tprot	Protection Delay Time	$V_{IN}=V_{CE}=5V$	A version		0.0	ms
			B/C/D version		0.1	
$V_{UVLO1}$	UVLO Detector Threshold	$V_{IN}=V_{CE}$	3.40	3.50	3.60	V
$V_{UVLO2}$	UVLO Release Voltage	$V_{IN}=V_{CE}$	3.63	3.73	3.83	V

All test items listed under *ELECTRICAL CHARACTERISTICS* are done under the pulse load condition ( $T_j \approx T_a = 25^{\circ}C$ ) except Thermal Shutdown.

**VR SECTION**

(Ta=25°C)

Symbol	Parameter	Conditions	Min.	Typ.	Max.	Unit
V <sub>OUT2</sub>	Output Voltage 2	V <sub>IN</sub> =5V, I <sub>OUT</sub> =1mA	-1.0%		+1.0%	V
I <sub>LIM2</sub>	Current Limit 2		600			mA
I <sub>SS3</sub>	Supply Current 3	V <sub>IN</sub> =V <sub>CE</sub> =5.5V		60		μA
$\frac{\Delta V_{OUT2}}{\Delta I_{OUT2}}$	Load Regulation	1mA ≤ I <sub>OUT2</sub> ≤ 400mA		40	80	mV
$\frac{\Delta V_{OUT2}}{\Delta Ta}$	Output Voltage 2 Temperature Coefficient	-40°C ≤ Ta ≤ 85°C		±50		Ppm /°C
I <sub>SC</sub>	Short Current Limit	V <sub>OUT2</sub> =0V		70		mA
T <sub>VR</sub> (A/B version)	Start-up Timing Delay	Start from the finish moment of soft start-time of DC/DC converter		2.0		ms
T <sub>VR</sub> (C/D Version)	Start-up Delay	Start from UVLO release moment of DC/DC converter		50		μs
R <sub>LOW</sub>	For auto discharge at off, N-channel Tr. ON resistance	V <sub>IN</sub> =5V, V <sub>CE</sub> =0V		50		Ω

**VD SECTION**

(Ta=25°C)

Symbol	Parameter	Conditions	Min.	Typ.	Max.	Unit
-V <sub>DET</sub>	VD Detector Threshold		-2.0%		+2.0%	V
$\frac{\Delta -V_{DET}}{\Delta Ta}$	VD Detector Threshold Temperature Coefficient	-40°C ≤ Ta ≤ 85°C		±40		ppm /°C
V <sub>HYS</sub>	Hysteresis Range			$\frac{-V_{DET}}{x 0.05}$		V
T <sub>PLH</sub>	VD Release Delay Time			50		ms
I <sub>DOUTL</sub>	V <sub>DOUT</sub> "L" Output Current	V <sub>IN</sub> =2.0V, V <sub>DOUT</sub> =0.1V	1.0	4.0		mA

All test items listed under *ELECTRICAL CHARACTERISTICS* are done under the pulse load condition (T<sub>j</sub>≈Ta=25°C) except Thermal Shutdown.

## TYPICAL APPLICATION AND TECHNICAL NOTES

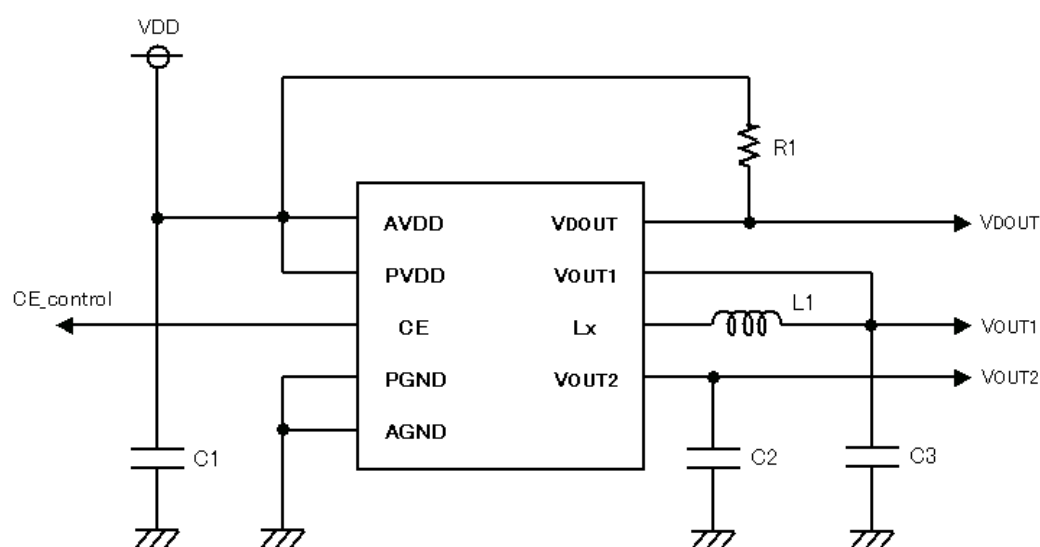

### External Components Recommendation

Inductor L1: 4.7 $\mu$ H (A/B/C Version VLF4014AT-4R7M1R1 TDK)

4.7 $\mu$ H (D Version VLF4014ST-4R7M1R4 TDK)

Pull-up Resistance R1: 50k $\Omega$

Capacitors C1: 10 $\mu$ F Ceramic capacitor (C2012JB0J106K TDK)

C2: 2.2 $\mu$ F Ceramic capacitor

C3: 10 $\mu$ F Ceramic capacitor (C2012JB0J106K TDK)

## TECHNICAL NOTES ON EXTERNAL COMPONENTS

- Place all the external components as close as possible to the IC and make the wiring length as short as possible. Especially, the capacitor between  $V_{IN}$  and GND must be as close as possible to the IC. If the impedance of the power supply and ground is high, the power level of the IC may shift by the switching current and the operation may be unstable. Make the power line and the ground line sufficient. Through the power line, the ground line, inductor,  $L_x$  pin,  $V_{OUT}$  line, large current may flow by switching, therefore full consideration is necessary. The wiring between  $V_{OUT}$  pin and the inductor, and load and  $V_{OUT}$  pin must be separated.
- PVDD and AVDD must be short and make them close as possible. Place a capacitor as close as possible to PVDD. If the distance between AVDD and PVDD is long, add another 0.1 $\mu$ F capacitor between AVDD and GND.
- Capacitance value between VDD and GND should be 10 $\mu$ F or more and use a low ESR ceramic capacitor. Use a ceramic capacitor for  $V_{OUT1}$  pin, and the capacitor should be 10 $\mu$ F or more. Use a ceramic capacitor for  $V_{OUT2}$  pin, and the ceramic capacitor should be 2.2 $\mu$ F or more.
- Choose an inductor with low DCR, and enough permissible current and which is hard to reach magnetic saturation. If the inductance value is too small, at the maximum load, the current flows through  $L_x$  transistor and inductor may be beyond the absolute maximum rating. Choose an appropriate inductance value.
- If the spike noise of  $L_x$  pin is large, place a snubber circuit between  $L_x$  and GND (CR serial connection, etc.) to reduce the spike noise. Time constants of CR depend on the actual PCB and decide with the evaluation of the PCB.
- ★ The performance of the power circuit with the IC depends on the peripheral circuits. In terms of the external components, PCB pattern, and IC, the peripheral circuit should be designed not to exceed beyond ratings (voltage, current, power).



## STEP-DOWN DC/DC CONVERTERS' OPERATION AND OUTPUT CURRENT

This explanation is about the general step-down DC/DC converters' operation.

In the step-down DC/DC converter, when the Lx transistor turns on, at the same time, energy is accumulated into an inductor and when the transistor turns off, the current accumulated in the inductor is released and averaged, then make the energy loss reduced and the output voltage lower than the input voltage is supplied.

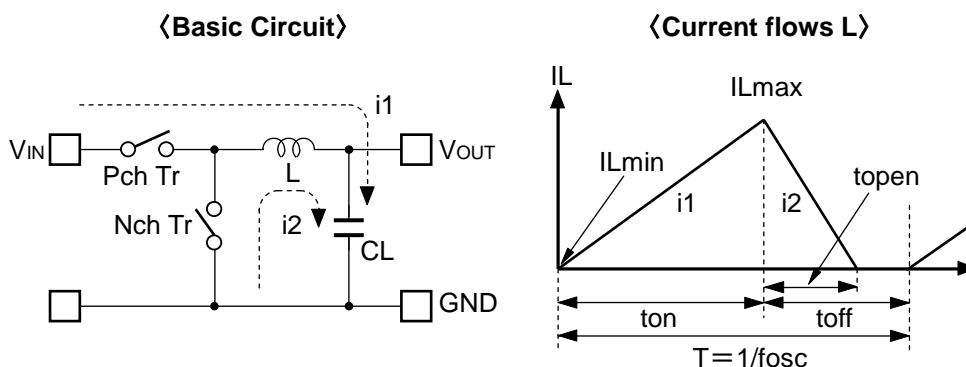

- Step1. P-channel transistor turns on, current  $IL=i1$ , energy is charged into L, CL is charged and the output current  $I_{OUT}$  is supplied. While the P-channel transistor turns on ( $t_{ON}$ ), and in proportion to  $IL=i1$  is from  $IL=IL_{min}=0$  increases and reaches to  $IL_{max}$ .
- Step2. P-channel transistor turns off, L keeps  $IL=IL_{max}$ , and turns on the N-channel transistor, current  $IL=i2$  flows.
- Step3.  $IL=i2$  decreases gradually, after  $t_{OPEN}$ ,  $IL=IL_{min}=0$  and N-channel transistor turns off. However, if the cycle is continuous mode, before  $IL=IL_{min}=0$ ,  $t_{OFF}$  time becomes nothing, the next cycle starts and the P-channel transistor turns on, and the N-channel transistor turns off. In this case,  $IL_{min} > 0$  and charge is remained, and charge is increased from  $IL=IL_{min} > 0$ .

In the PWM control, the number of switching in a second ( $f_{OSC}$ ) is fixed, and  $t_{ON}$  is controlled and the output voltage is constantly maintained.

The step-down operation is constant and stable, the current flows through the inductor's maximum value ( $IL_{max}$ ) and the minimum value ( $IL_{min}$ ) is same as when the P-channel transistor turns on and off as described above. Supposed that the difference between  $IL_{max}$  and  $IL_{min}$  is  $\Delta I$ ,

$$\Delta I = IL_{max} - IL_{min} = V_{OUT} \times t_{OPEN} / L = (VIN - VOUT) \times t_{ON} / L \dots\dots\dots \text{Formula 1}$$

Thus,

$$T = 1 / f_{OSC} = t_{ON} + t_{OFF}$$

$$\text{duty (\%)} = t_{ON} / T \times 100 = t_{ON} \times f_{OSC} \times 100$$

$$t_{OPEN} \quad t_{OFF}$$

The left side of the equation describes the current level at turning on, and the right side of the equation describes the current level at turning off.

## OUTPUT CURRENT AND SELECTION OF EXTERNAL COMPONENTS

In the general step-down DC/DC converters, the relation between the output current and external components is described as below:

(Supposed that the peak to peak value of the ripple current is “ $I_{RP}$ ”, On resistance of the  $L_X$  transistor, P-channel transistor, N-channel transistor is respectively described as “ $R_{ONP}$ ” and “ $R_{ONN}$ ”, inductor’s DCR is described as “ $R_L$ ”)

Supposed that the time when  $L_X$  P-channel transistor turns on is described as “ $t_{ON}$ ”,

$$V_{IN} = V_{OUT} + (R_{ONP} + R_L) \times I_{OUT} + L \times I_{RP} / t_{ON} \dots\dots\dots \text{Formula 1}$$

Supposed that the time when  $L_X$  P-channel transistor turns off (N-channel transistor turns on) is described as “ $t_{OFF}$ ”,

$$L \times I_{RP} / t_{OFF} = (R_{ONN} + R_L) \times I_{OUT} + V_{OUT} \dots\dots\dots \text{Formula 2}$$

Using Formula 1 and Formula 2, and On duty of the P-channel transistor,  $t_{ON} / (t_{ON} + t_{OFF}) = D_{ON}$  is solved,

$$D_{ON} = (V_{OUT} + R_{ONN} \times I_{OUT} + R_L \times I_{OUT}) / (V_{IN} - R_{ONP} \times I_{OUT} + R_{ONN} \times I_{OUT}) \dots\dots\dots \text{Formula 3}$$

Ripple current is

$$I_{RP} = (V_{IN} - V_{OUT} - R_{ONP} \times I_{OUT} - R_L \times I_{OUT}) \times D_{ON} / f_{OSC} / L \dots\dots\dots \text{Formula 4}$$

Then the peak current through the inductor and  $L_X$  transistor,

$$I_{Lmax} = I_{OUT} + I_{RP} / 2 \dots\dots\dots \text{Formula 5}$$

Decide the peripheral circuits with considering  $I_{Lmax}$  and input and output conditions.

★ The calculation is based on the ideal operation of the PWM continuous mode.

## TIMING CHART (A Version)

### (1) Start-up and shutdown by detecting UVLO

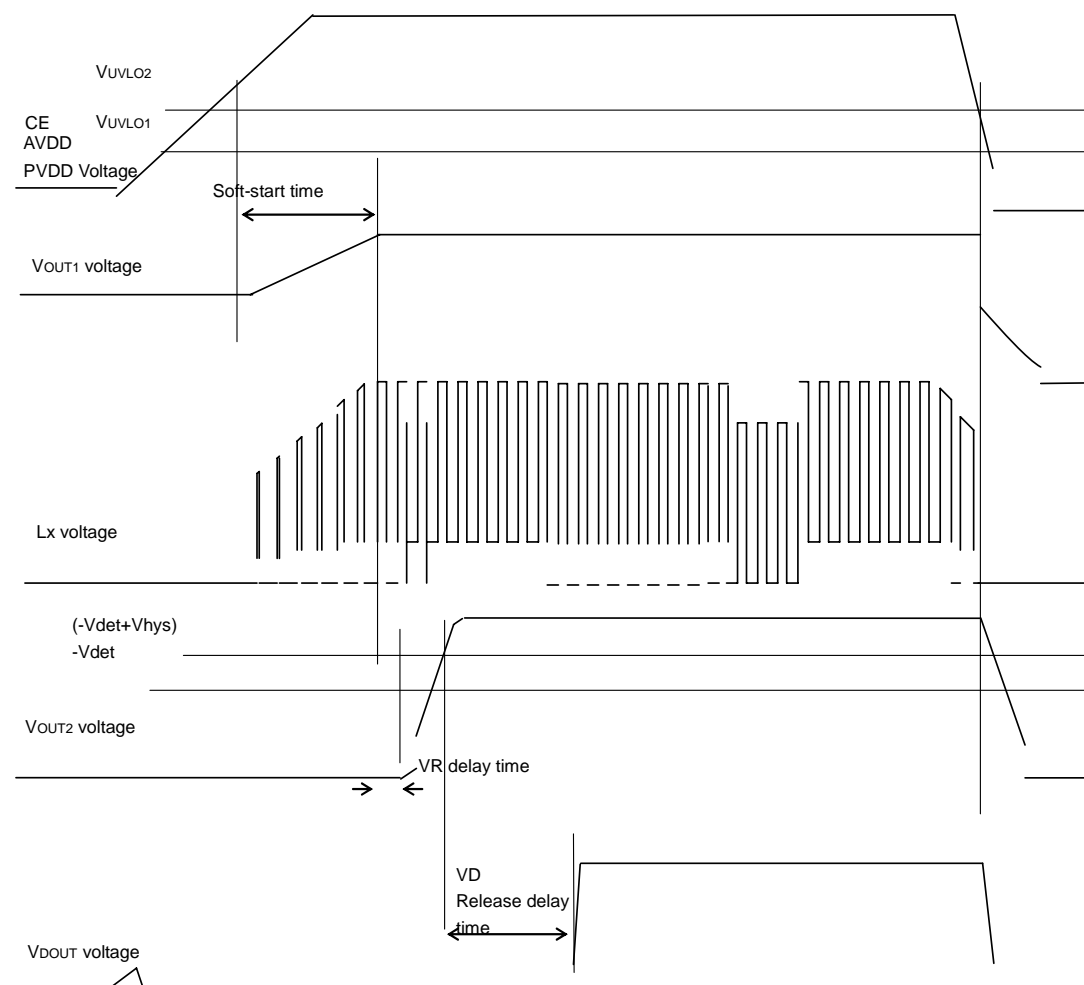

Timing chart of the power supply voltage change and DC/DC converter, VD, and VR can be explained as below:

#### ( 1 ) DC/DC converter

Power supply is forced and when VDD voltage increases, if VDD voltage is equal or less than the UVLO release voltage (VUVLO2), the operation of DC/DC converter stops and switching is halted, therefore the voltage, VOUT1 does not rise. When the VDD voltage becomes equal or more than UVLO release voltage, the DC/DC converter starts soft-start and switching begins and the voltage, VOUT1 rises. After the soft-start time, VDD voltage becomes set equal or more than VOUT1 voltage, VOUT1 voltage becomes set output voltage. When VDD voltage becomes equal or less than UVLO detector threshold (VUVLO1), DC/DC converter stops switching and turns off the Lx transistor inside the IC.

#### ( 2 ) VR

After the soft-start time of the DC/DC converter, VR starts up with delay time. The operation stops when VDD voltage becomes equal or less than UVLO detector threshold (VUVLO1), then auto-discharge function starts.

#### ( 3 ) VD

When VOUT2 voltage becomes equal or more than VD detector threshold voltage + hysteresis width (-VDET + VHYS), after the VD release delay time (TPLH), N-channel transistor of the IC turns off, VDOUT pin is pulled up with an external resistance and becomes pull-up voltage. When VDD voltage becomes equal or less than UVLO detector threshold (VUVLO1), then N-channel transistor of VDOUT pin turns on and VDOUT pin outputs "L". (Depending on VOUT1 or VOUT2, VDOUT pin outputs "L". Refer to the timing chart. )

(2) Start-up and Turning off by detecting over current of DC/DC converter

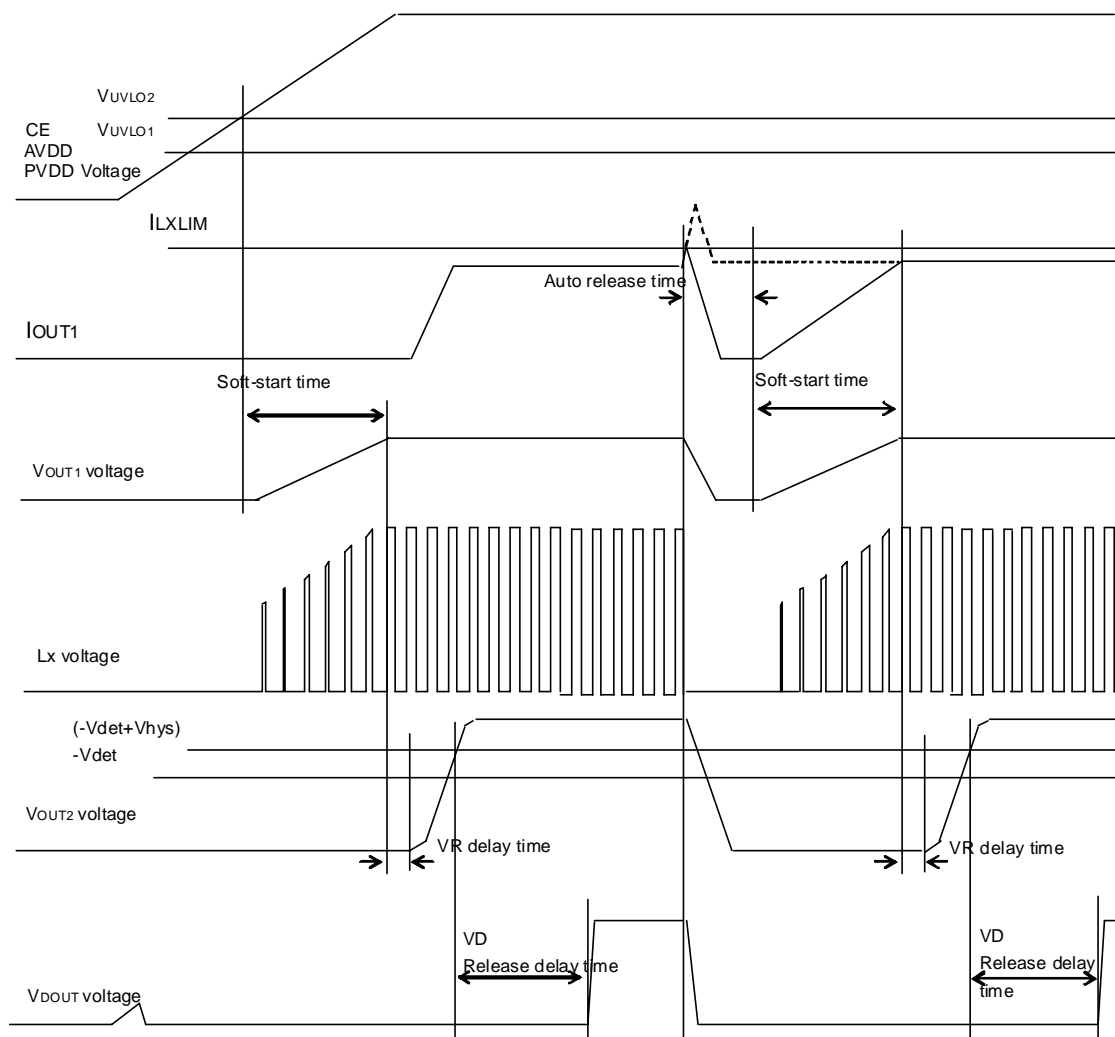

Timing chart of DC/DC converter output change by load, VD and VR can be explained as below:

( 1 ) DC/DC converter

When LX peak current (IOUT1) is beyond the current limit (ILXLIM),\*1 the protection circuit operates and switching stops and Lx transistor inside the IC turns off and restarts after a certain time.

\*1) During soft-start time, if IOUT1 is beyond ILXLIM, the protection circuit does not work.

( 2 ) VR

When the DC/DC converter stops and at the same time, VR operation stops and auto-discharge function operates. To release it, after the soft-start time of the DC/DC converter, VR starts up with delay.

( 3 ) VD

When the DC/DC converter stops and at the same time, the N-channel transistor of VDOUT pin turns on, VDOUT pin outputs "L". To release it, when VOUT2 voltage becomes equal or more than VD detector threshold + hysteresis width (-VDET + VHYS), after VD release delay time (TPLH) the N-channel transistor inside the IC turns off and VDOUT pin becomes pull-up voltage by an external resistance.

**(3) Start-up and Turning off by VR output decrease**

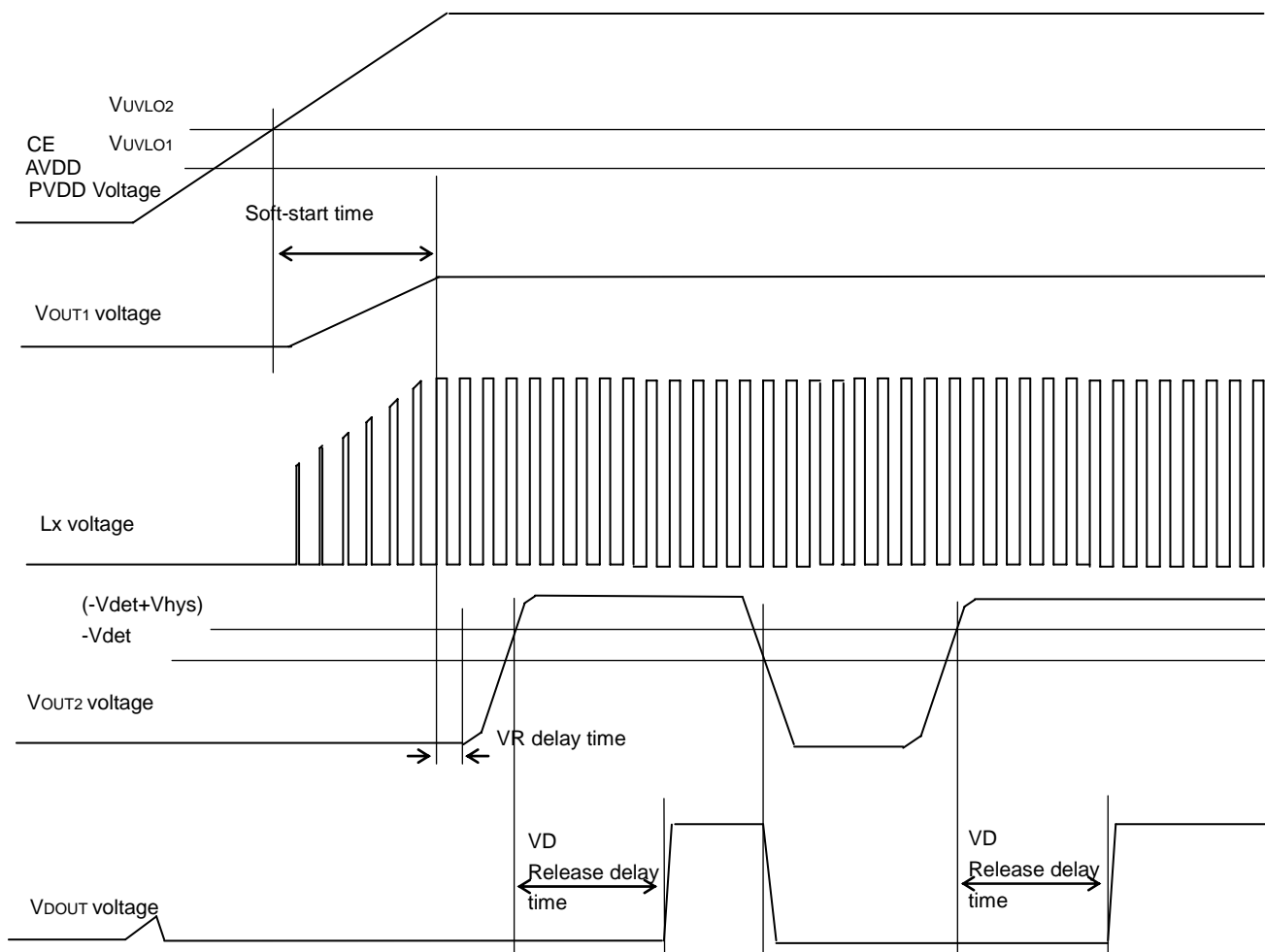

Timing chart of turning off by VR output voltage decreases, DC/DC converter, VD and VR can be explained as below:

**( 1 ) DC/DC converter**

DC/DC converter operates regardless of the operation of VR.

**( 2 ) VR**

Since the short current limit is built-in, if the output is short to the GND or over- current flows, the output decreases with current limit. If the over current is released and set output voltage appears.

**( 3 ) VD**

If VOUT2 becomes equal or less than VD detector threshold (-VDET), N-channel transistor of VDOUT pin turns on and VDOUT pin outputs "L". To release VD, when the voltage of VOUT2 becomes equal or more than VD detector threshold+hysteresis width (-VDET + VHYS), after VD release delay time (TPLH), the N-channel transistor inside the IC turns off, VDOUT pin becomes pull-up voltage by an external resistance.

## TIMING CHART (B Version)

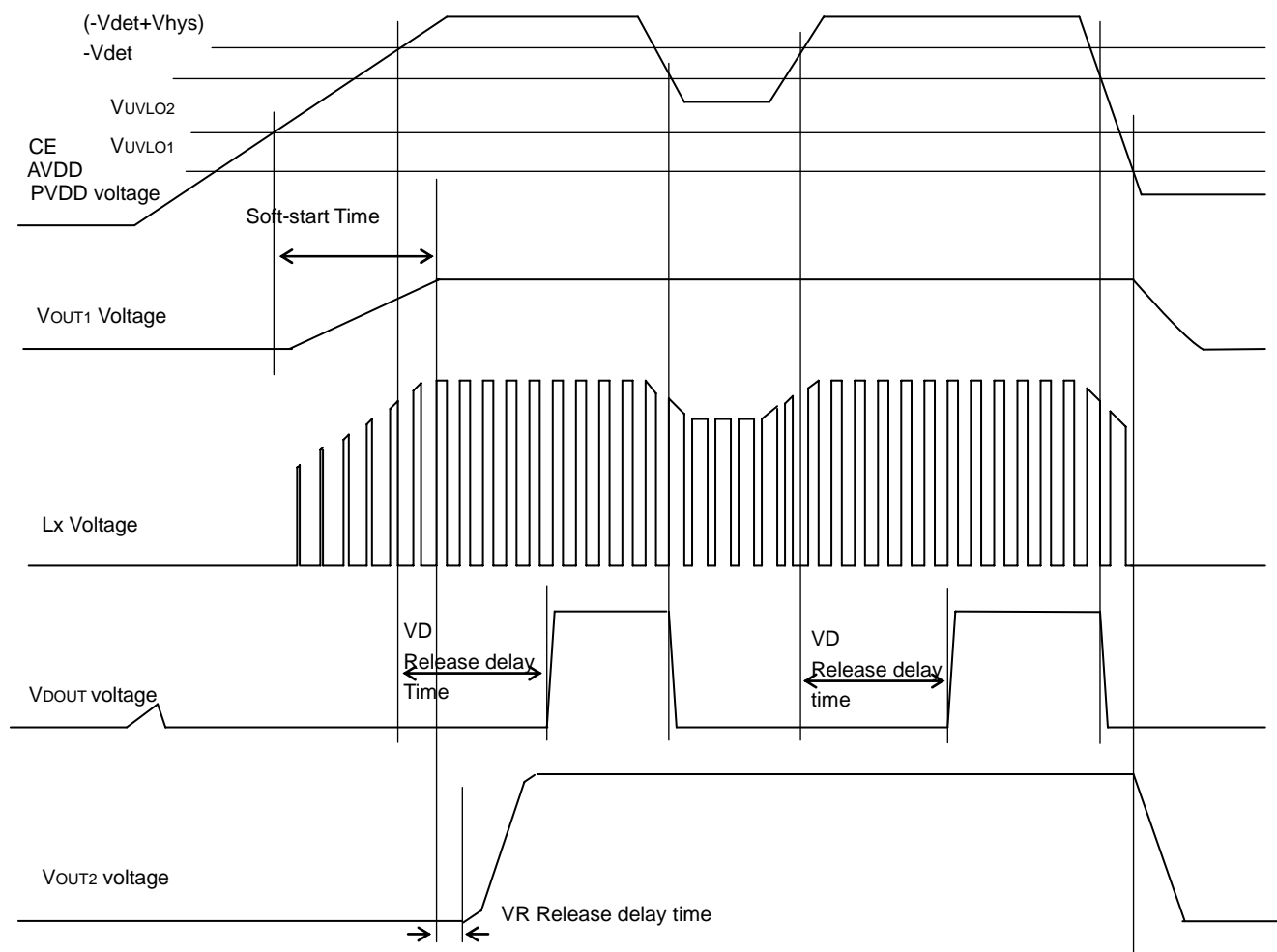

Timing chart with Power supply change and DC/DC converter, VD and VR can be explained as below:

### ( 1 ) DC/DC converter

Power supply is forced and VDD voltage increases, and if VDD voltage becomes equal or less than UVLO release voltage (VUVLO2), DC/DC converter operation stops and becomes no switching, therefore, VOUT1 voltage does not rise. When VDD voltage becomes equal or more than UVLO release voltage, the DC/DC converter starts soft-start and switching starts and VOUT1 voltage rises. After the soft-start time, if VDD voltage becomes equal or more than VOUT1 set voltage, VOUT1 voltage becomes set output voltage. When VDD voltage becomes equal or less than UVLO detector threshold (VUVLO1), the DC/DC converter stops switching and Lx transistor inside the IC turns off.

### ( 2 ) VR

After the soft-start of DC/DC converter, VR starts up with delay. When the voltage of VDD becomes equal or less than UVLO detector threshold (VUVLO1), the operation stops and auto-discharge function starts.

### ( 3 ) VD

VD operates regardless of the DC/DC converter, VR, thermal shutdown circuit, and chip-enable function. If the voltage of VDD becomes equal or less than VD detector threshold (-VDET), N-channel transistor of VDOUT pin turns on and VDOUT pin outputs "L". Then, when the voltage of VDD becomes equal or more than VD detector threshold + hysteresis width (-VDET + VHYS), after VD release delay time(TPLH), N-channel transistor inside the IC turns off and VDOUT pin becomes pull-up voltage by an external resistance.

## TIMING CHART (C/D Version)

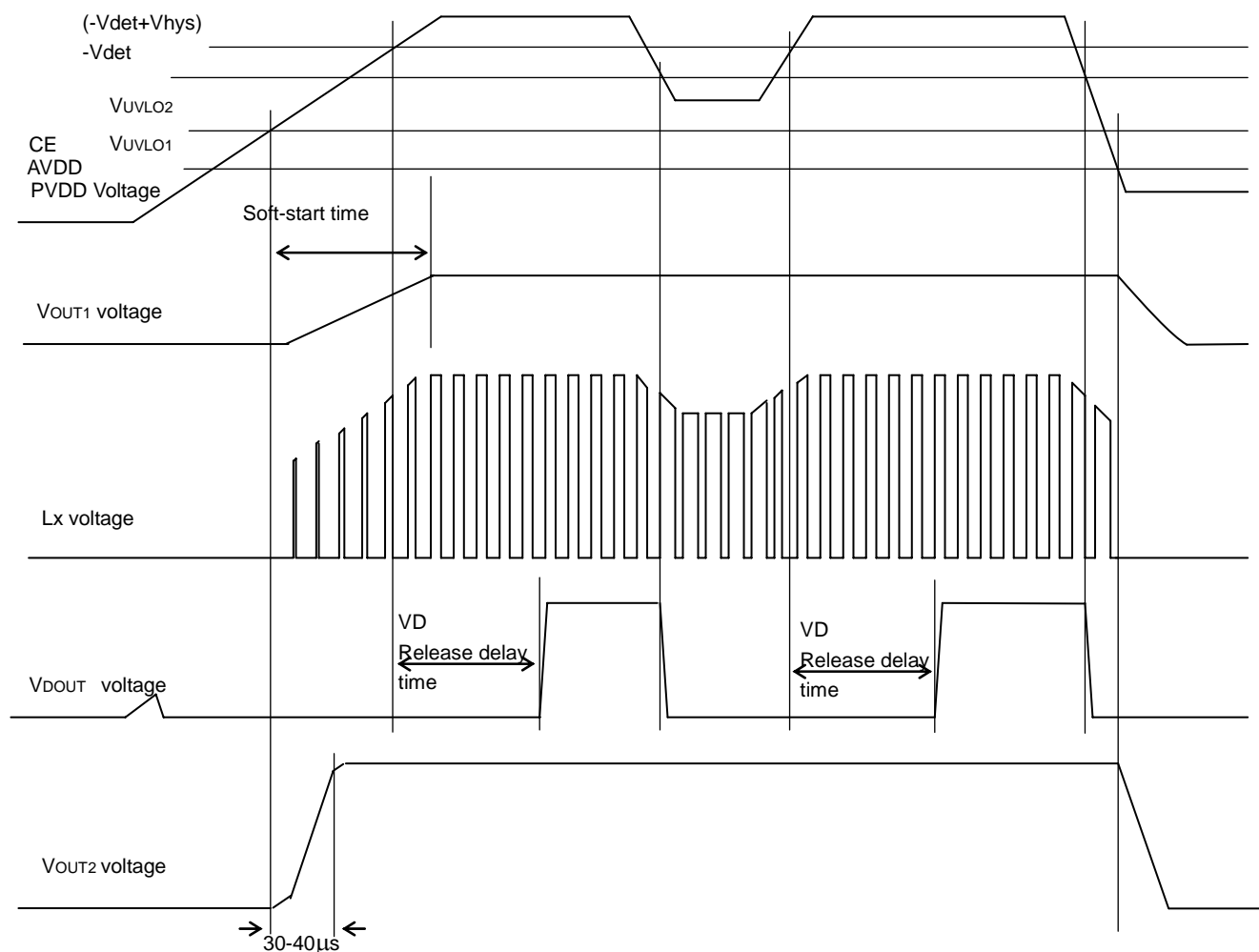

Timing chart of the power supply change, DC/DC converter, VD, VR can be explained as below:

### ( 1 ) DC/DC converter

Power supply is forced and when the voltage of VDD rises, the voltage of VDD is equal or less than UVLO release voltage ( $V_{UVLO2}$ ), DC/DC converter's operation stops and becomes no switching, therefore the voltage of VOUT1 does not rise. When the voltage of VDD becomes equal or more than UVLO release voltage, DC/DC converter starts soft-start and switching begins and the voltage of VOUT1 rises. After soft-start time, if the voltage of VDD becomes equal or more than the set VOUT1 voltage, the output of VOUT1 becomes set output voltage. When the voltage of VDD becomes equal or less than UVLO detector threshold ( $V_{UVLO1}$ ), DC/DC converter stops switching, Lx transistor inside the IC turns off.

### (2) VR

When the voltage of VDD becomes equal or more than UVLO release voltage, after the  $30\mu\text{s}$  to  $40\mu\text{s}$  or around, VR starts up. ( $C_{out}=2.2\mu\text{F}$ )  
If the voltage of VDD becomes equal or less than UVLO detector threshold ( $V_{UVLO1}$ ), the operations stops and auto-discharge function operates.

### ( 3 ) VD

VD operates regardless of DCDC, VR, thermal shutdown circuit, chip-enable function. When the voltage of VDD becomes or less than VD detector threshold ( $-V_{DET}$ ), N-channel transistor of VDOUT pin turns on, VDOUT pin outputs "L". Then when the voltage of VDD becomes equal or more than VD detector threshold + hysteresis width ( $-V_{DET} + V_{HYS}$ ), after VD release delay time (TPLH), N-channel transistor inside the IC turns off, VDOUT pin becomes pull-up voltage by an external resistance.

## TEST CIRCUITS

**Standby Current Test Circuit**

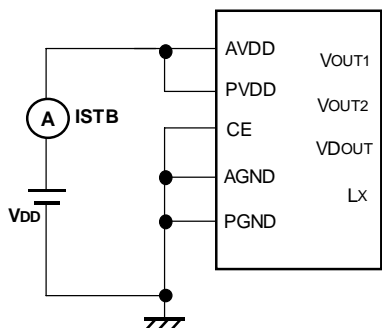

**Supply Current 1, 2 Test Circuit**

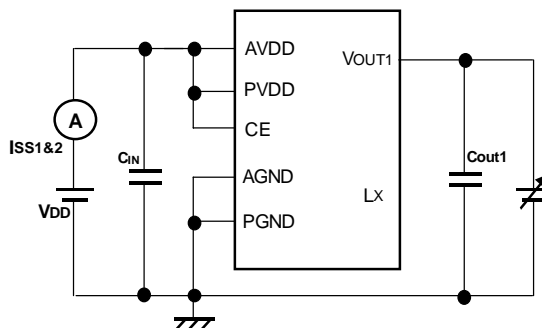

**DC/DC Output Voltage Test Circuit**

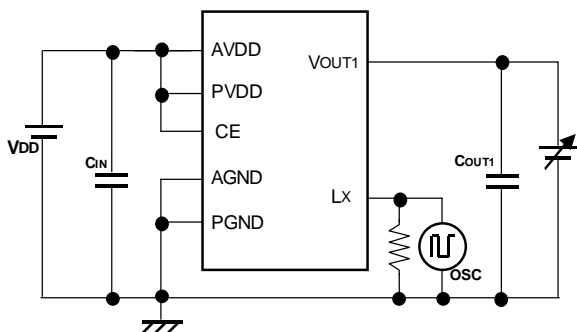

**DC/DC Oscillator Frequency Test Circuit**

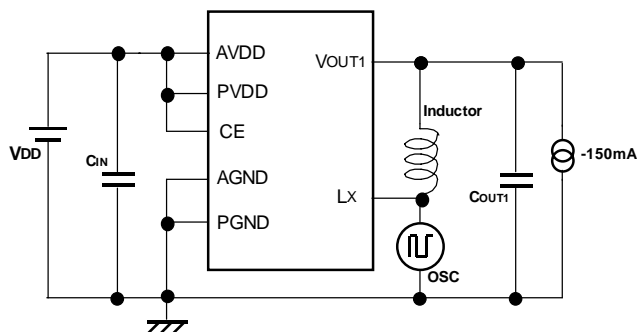

**UVLO Detect and Release Voltage Test Circuit**

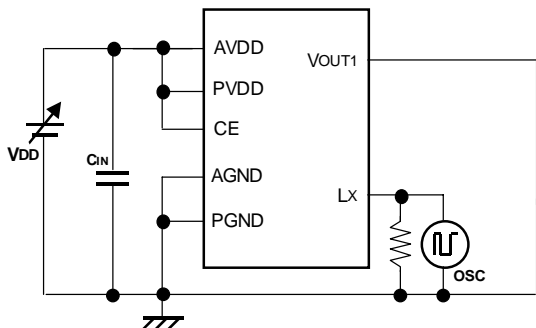

**VR Short Current Test Circuit**

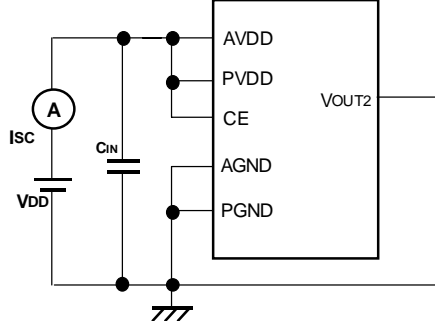

**VD Detect and Release Voltage Test Circuit  
(for B, C, D Version)**

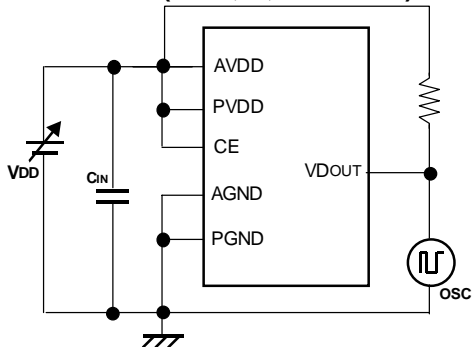



## TYPICAL CHARACTERISTIC

(unless otherwise specified, characteristics of C, D Version are same as B Version)

### 1) DC/DC output voltage vs. output current Version comparison

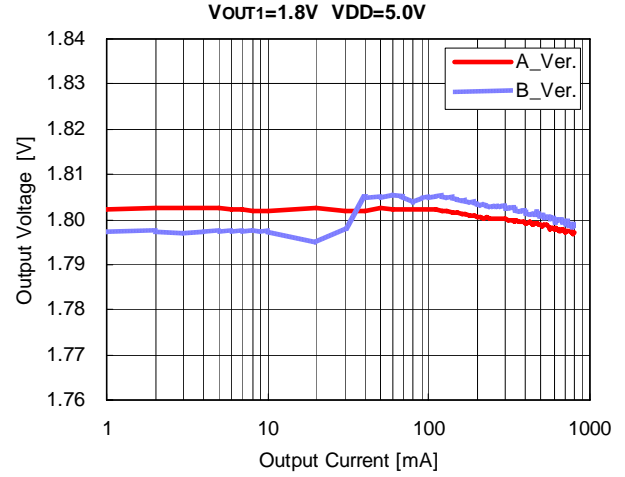
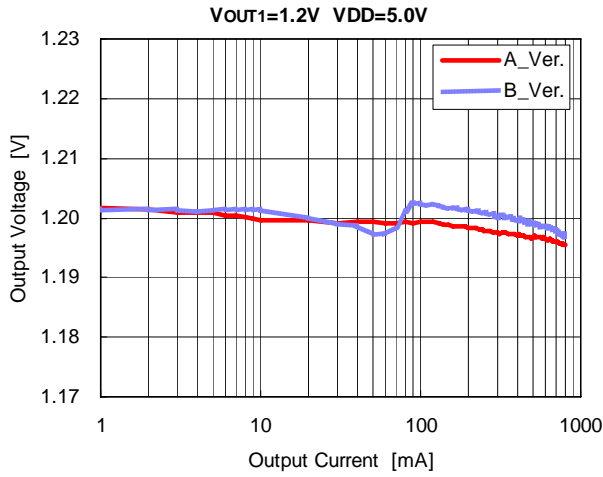

### Input voltage comparison

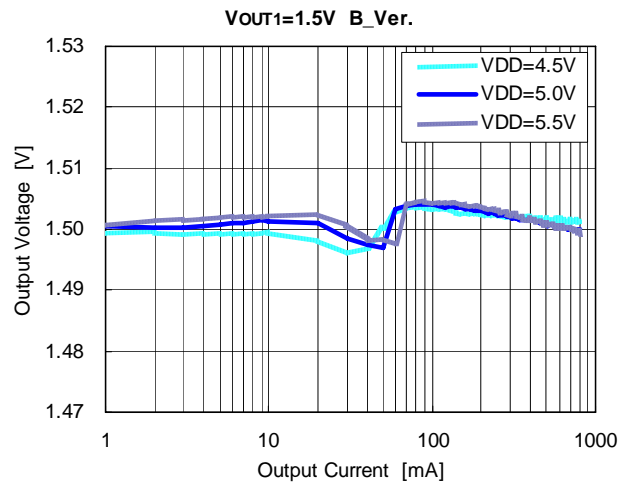
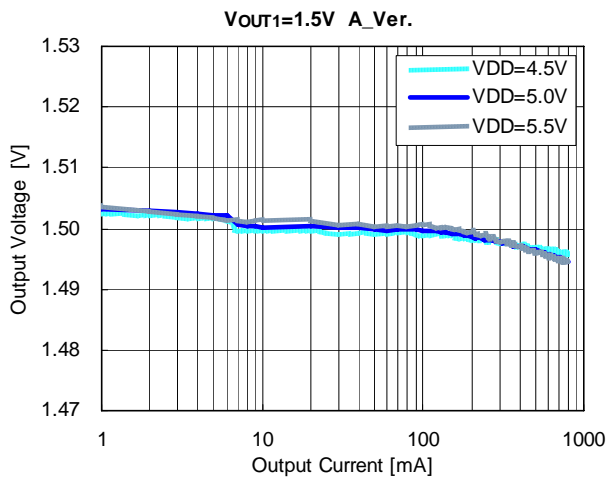

### 2) DC/DC output voltage vs. Input voltage

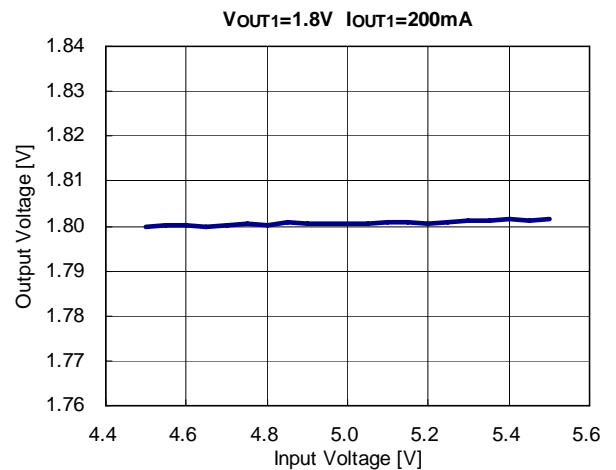
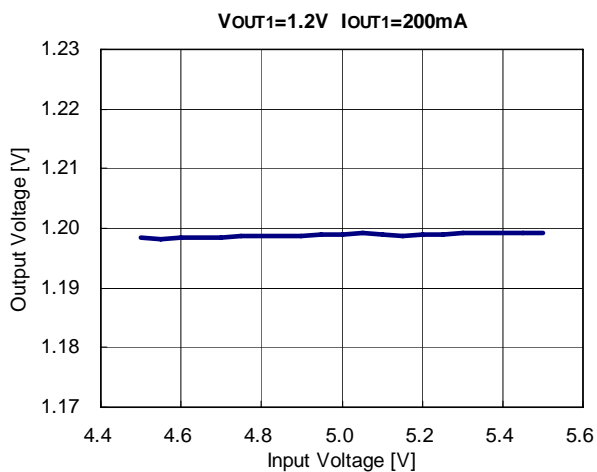

3) Efficiency vs. Output current  
(1) Version comparison

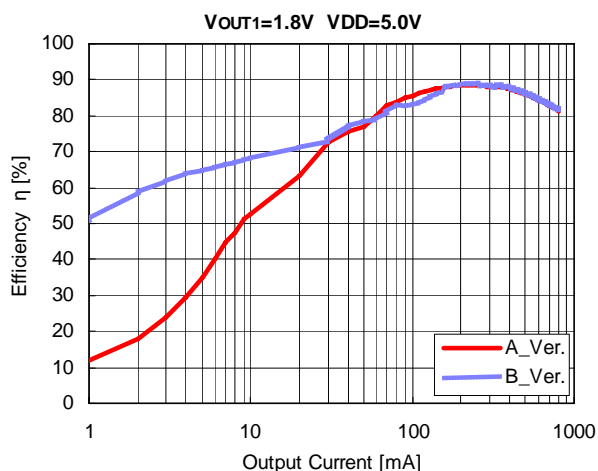
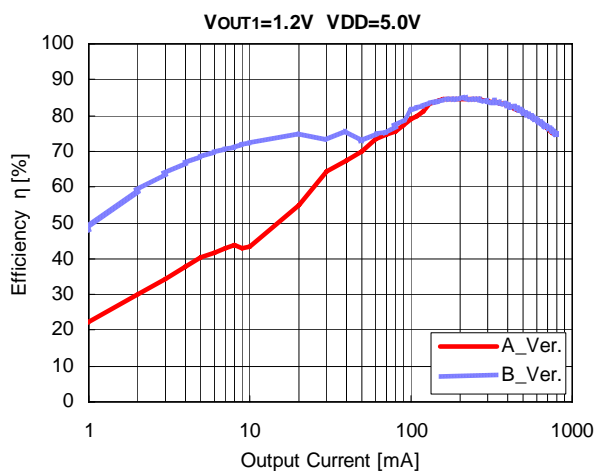

(2) Input voltage comparison

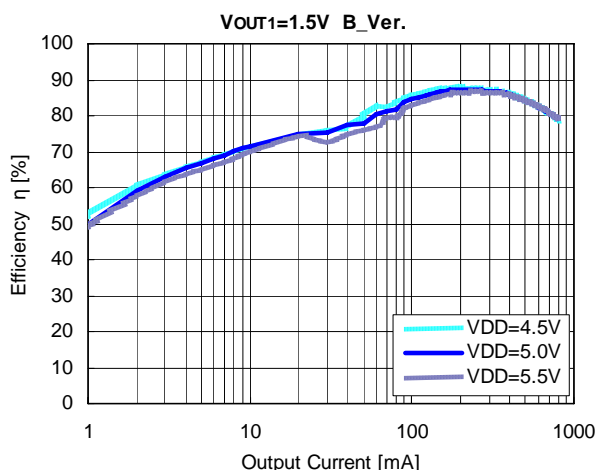
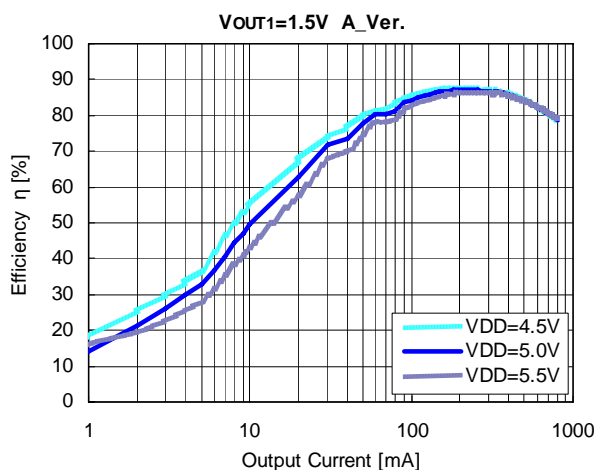

4) Standby Current vs. Temperature

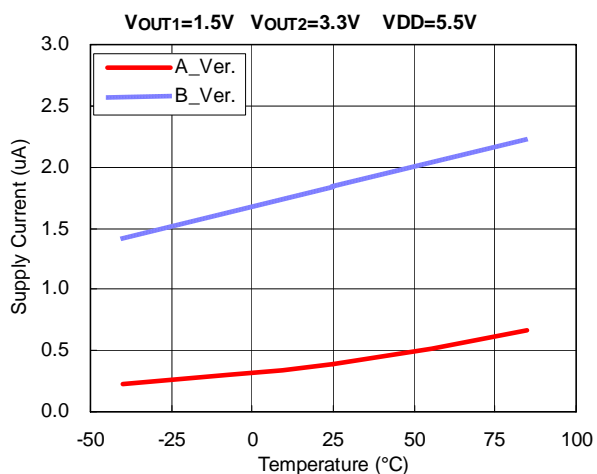

5) Supply Current 1, 2, 3 vs. Temperature

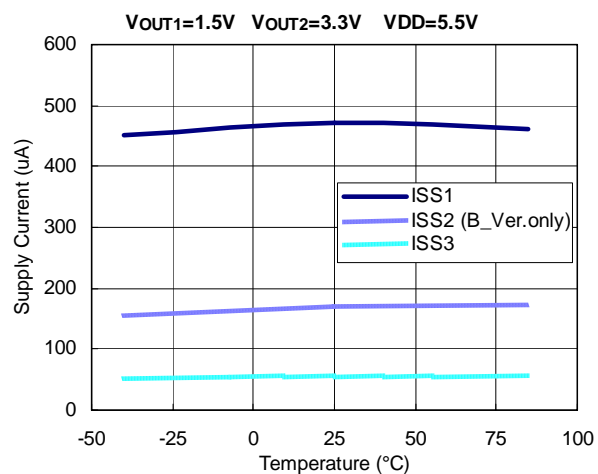

6) DC/DC output voltage vs. Temperature

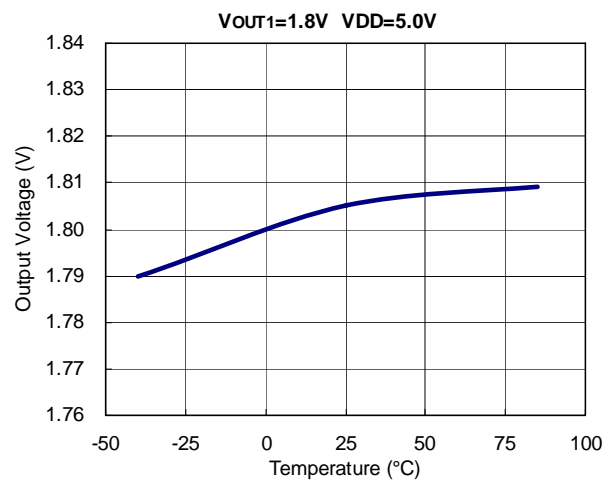
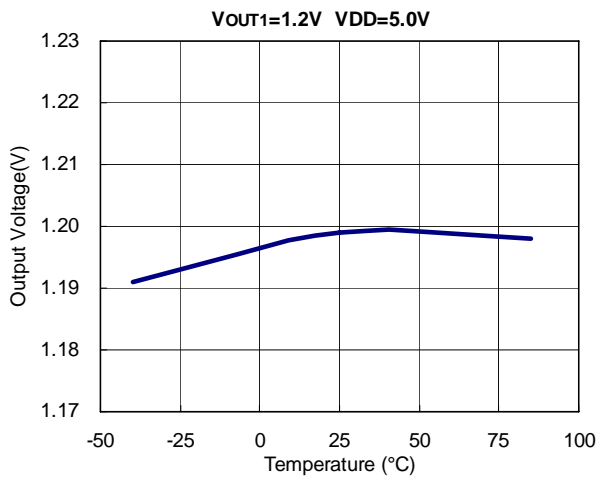

7) Oscillator frequency vs. Temperature

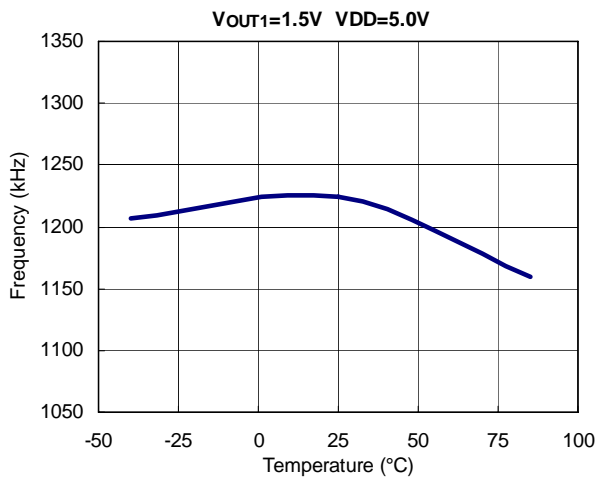

8) Oscillator frequency vs. Input voltage

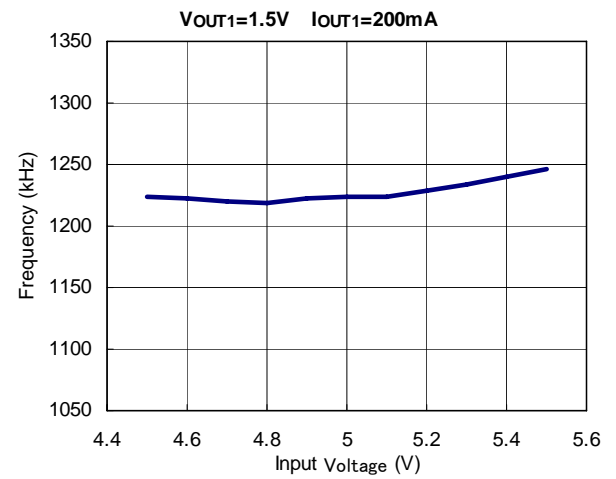

9) Soft-start time vs. Temperature

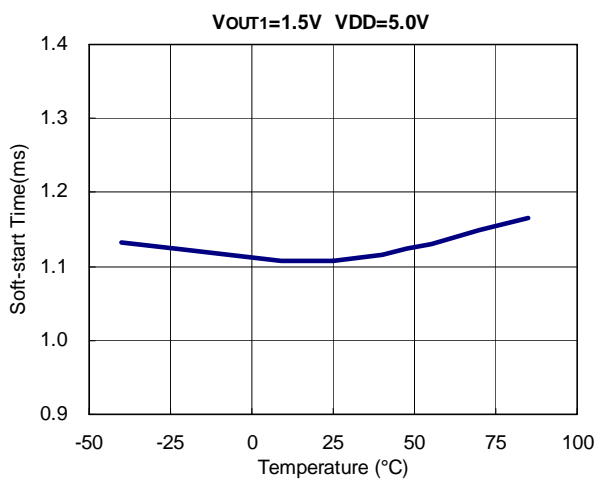

10) UVLO detect / release voltage vs. Input voltage

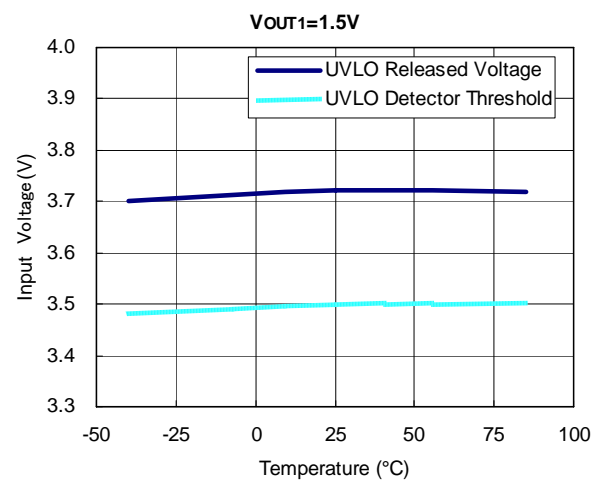

11) CE Input voltage vs. Temperature

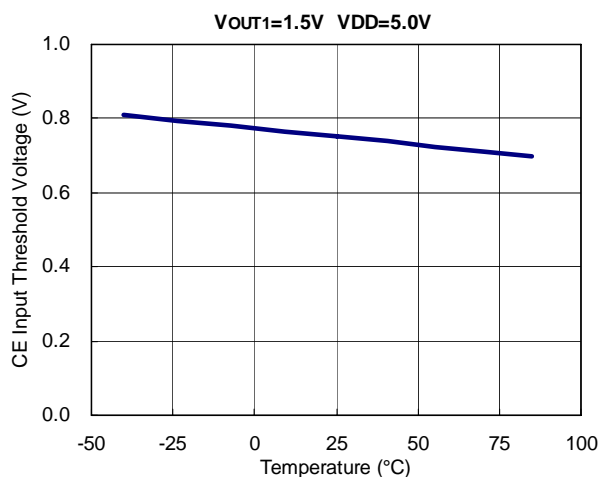

12) P-channel/N-channel Tr. ON resistance vs. Temperature

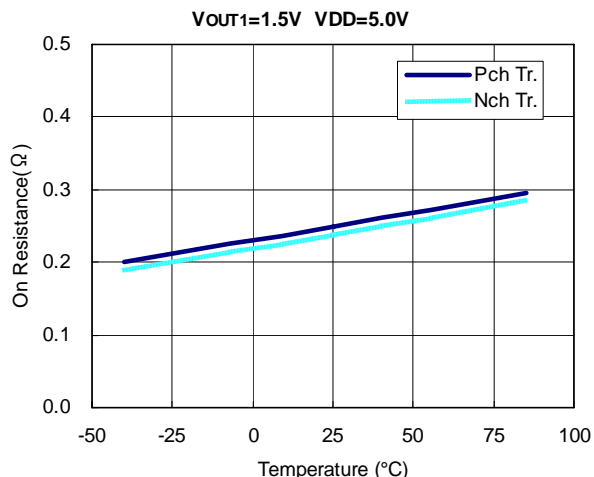

13) Lx Current limit vs. Temperature (Version comparison)

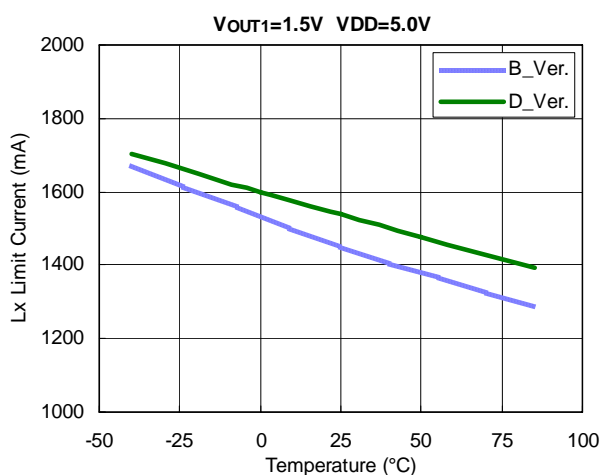

14) Protection delay time vs. Temperature (Version comparison)

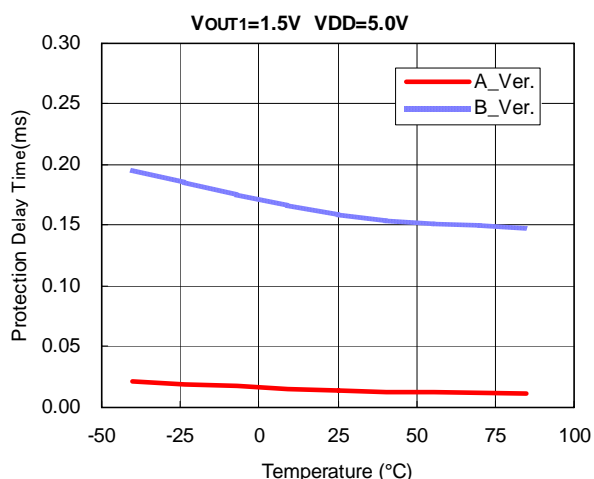

15) VR Output voltage vs. Temperature

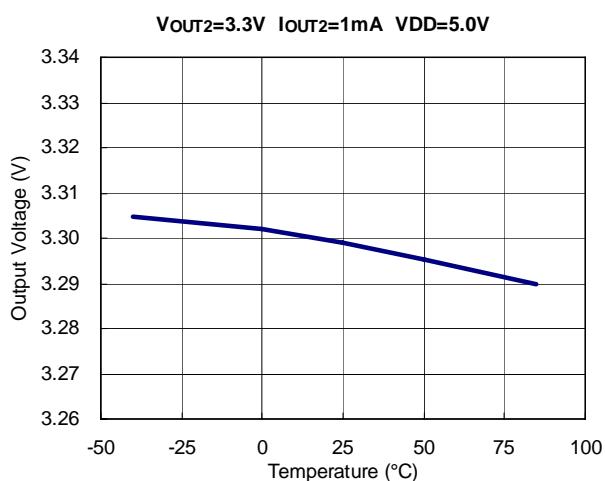
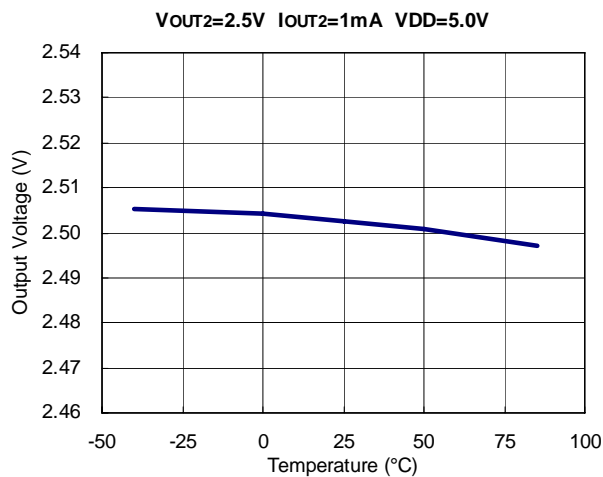

16) VR Output voltage vs. Output current

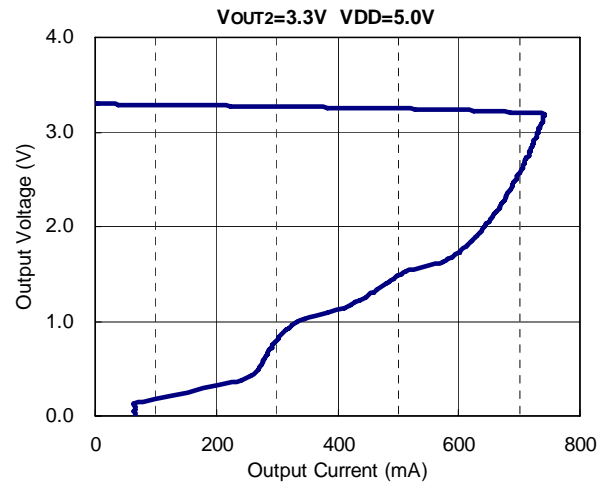
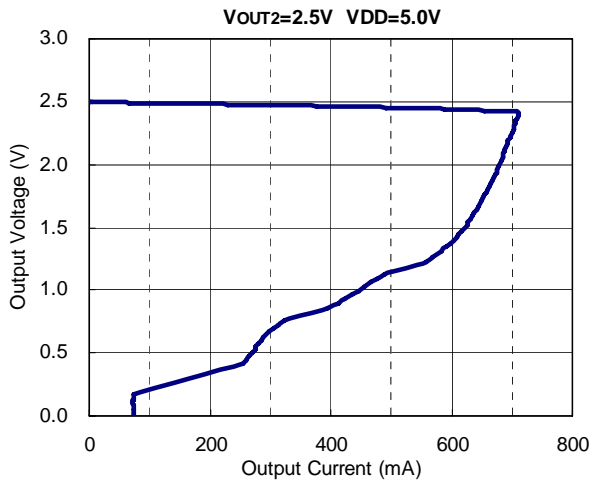

17) VD detect/ release voltage vs. Temperature (Version comparison)

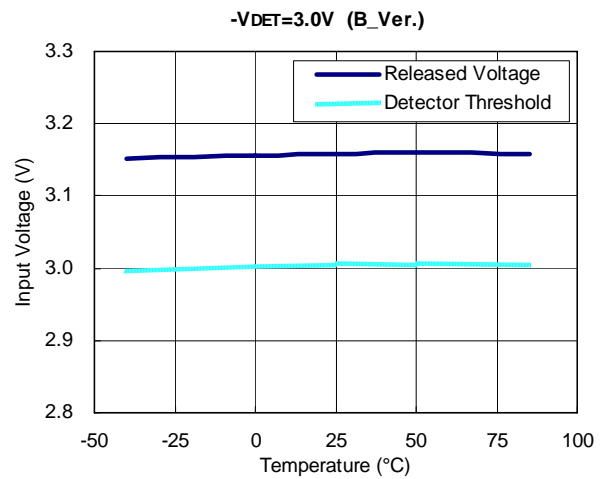
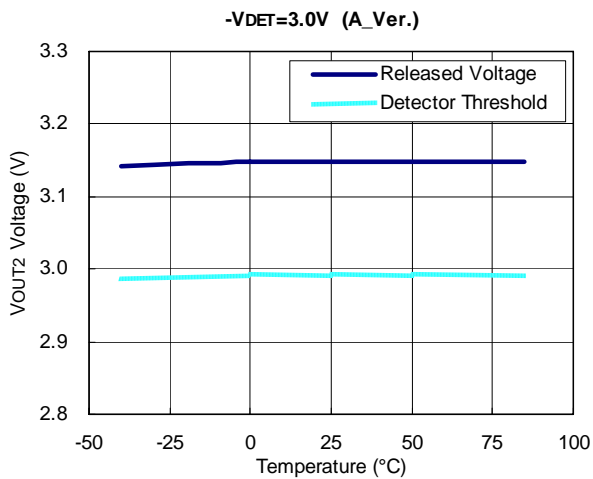

18) VDOUT "L" Output current vs. Temperature

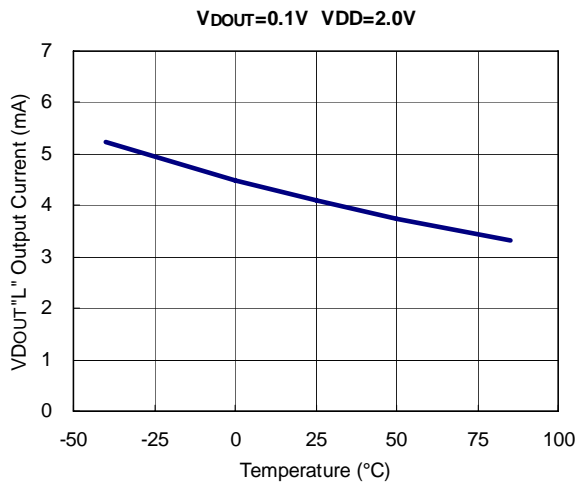

19) Release delay time vs. Temperature

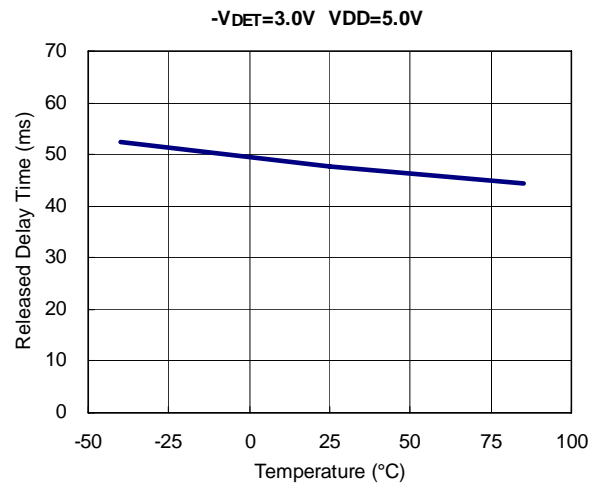

20) DC/DC Output voltage waveform (Version comparison)  
 (C<sub>IN</sub>=Ceramic 10uF, C<sub>OUT1</sub>= Ceramic 10uF, L=4.7uH, V<sub>DD</sub>=5.0V)

A Version

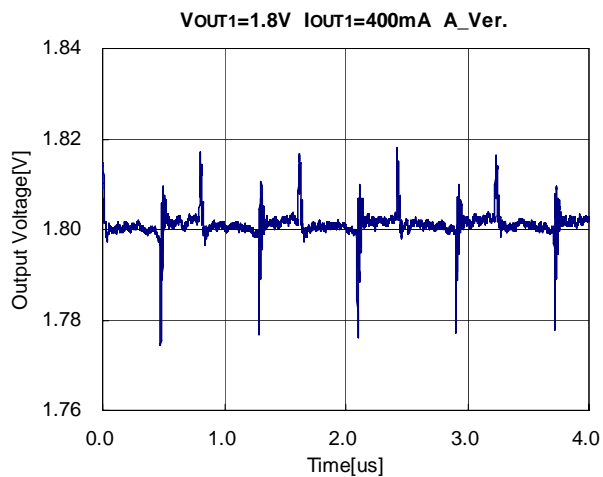
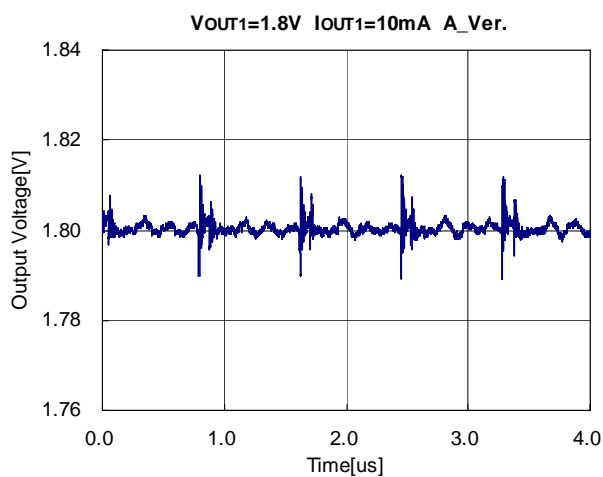
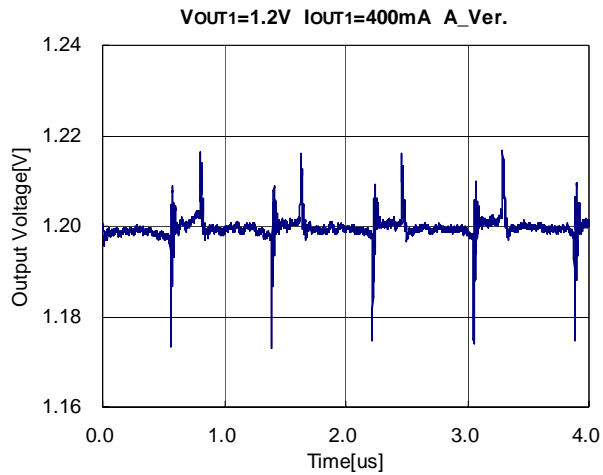
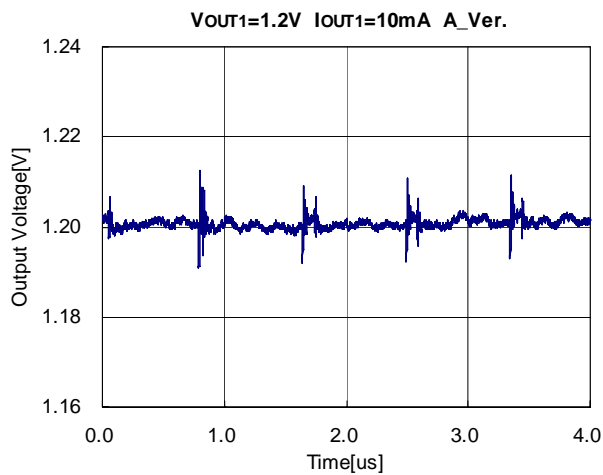

B Version

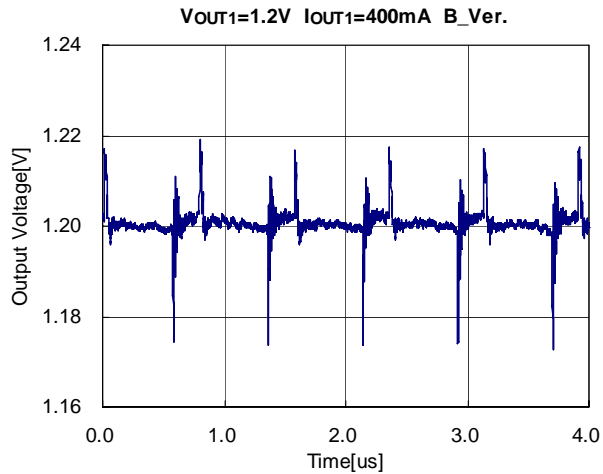
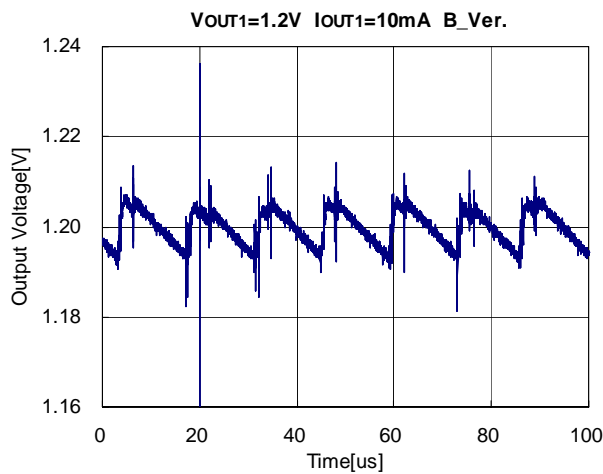

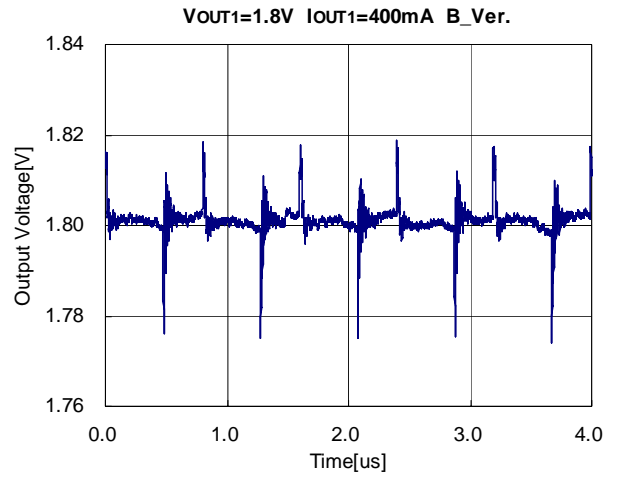
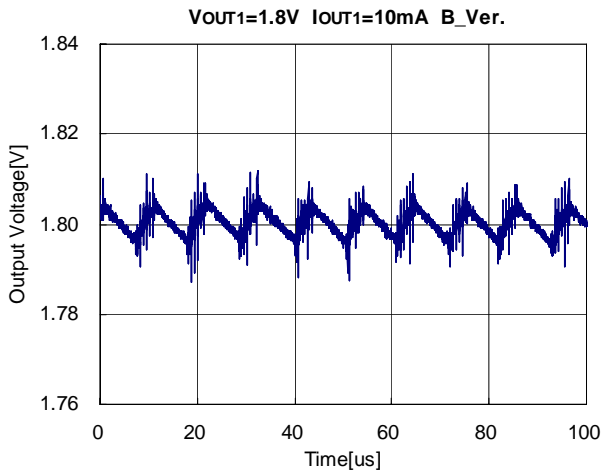

21) VOUT1, VOUT2 start-up waveform (Version comparison)

(CIN=Ceramic 10uF, COUT1= Ceramic 10uF, COUT2= Ceramic 2.2uF, L=4.7uH)

A, B Version

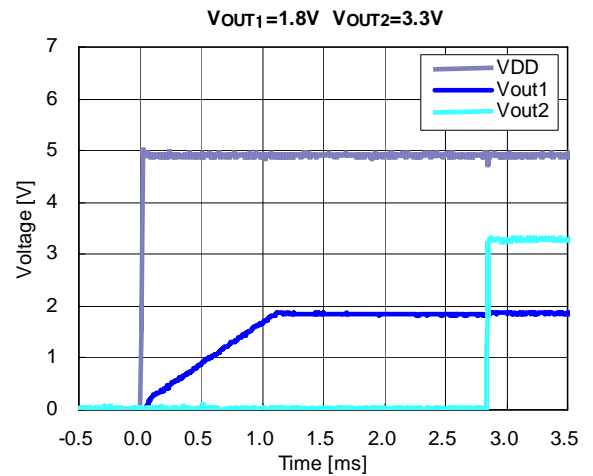
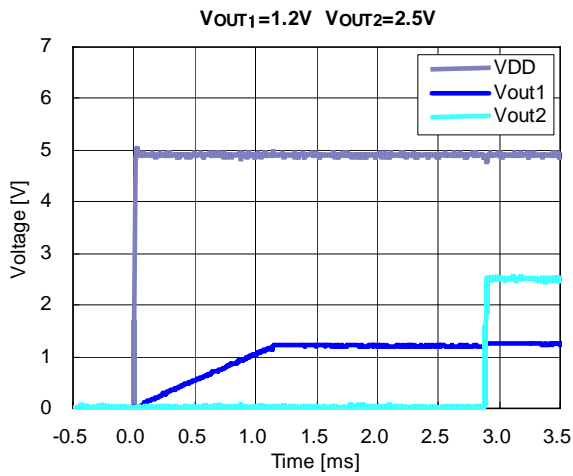

C, D Version

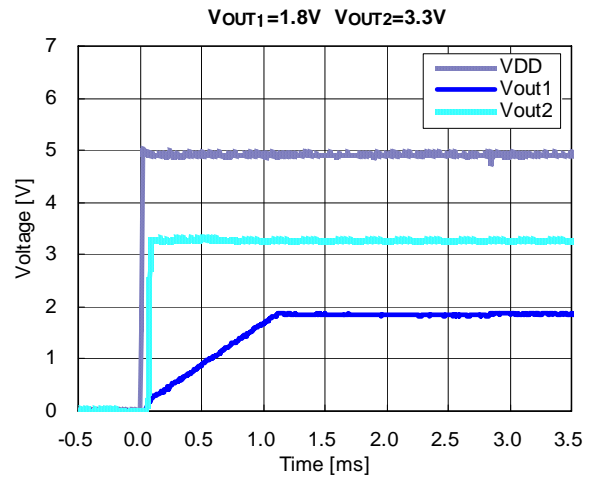
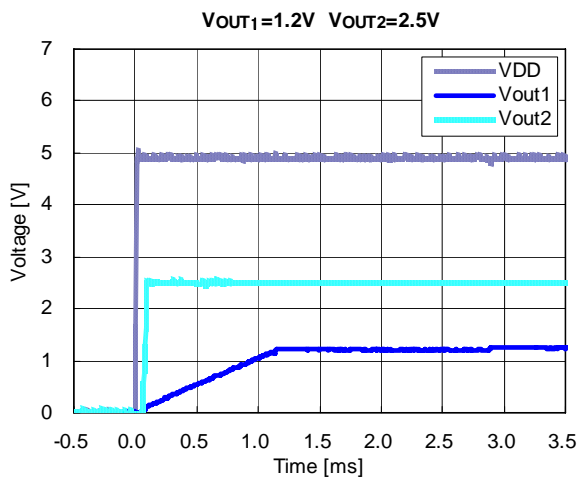

**22) VDOUT Release Delay Waveform (Version comparison)**  
 (CIN=Ceramic 10uF, COU1= Ceramic 10uF, COU2= Ceramic 2.2uF, L=4.7uH)

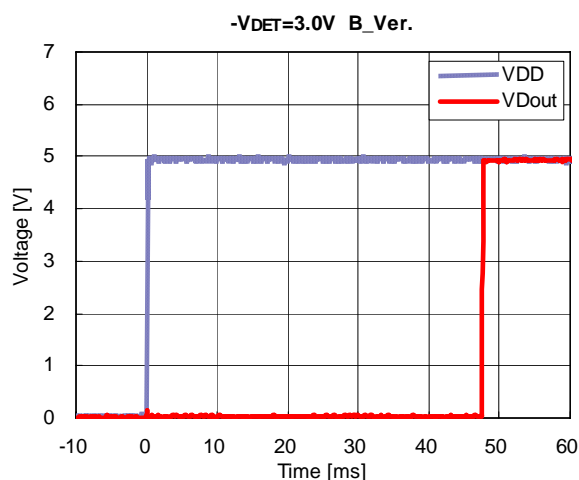
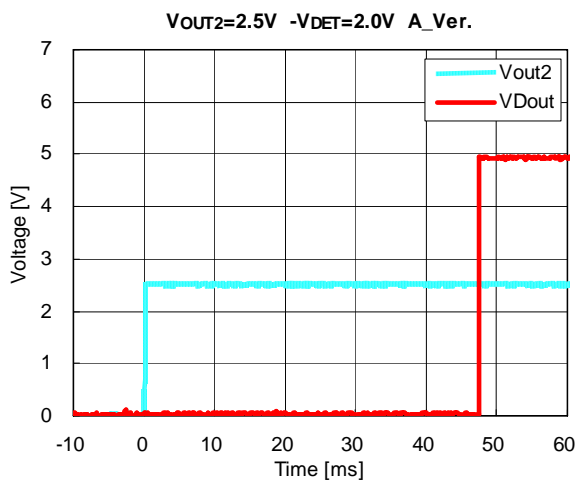

**23) DC/DC Load transient response (Version comparison)**  
 (CIN=Ceramic 10uF, COU1= Ceramic 10uF, L=4.7uH, VDD=5.0V)

**A Version, VOUT1=1.5V**

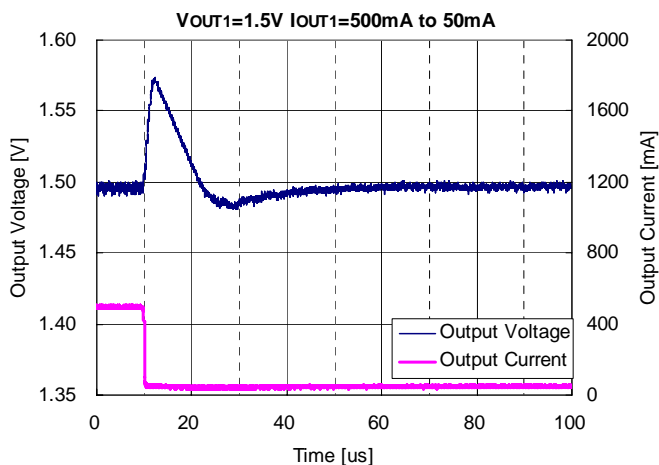
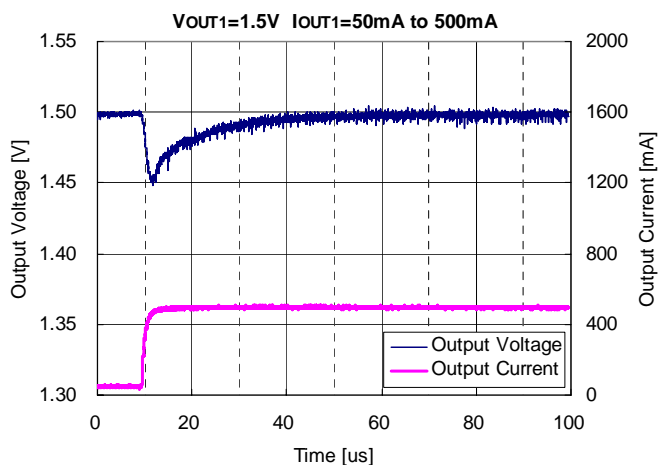
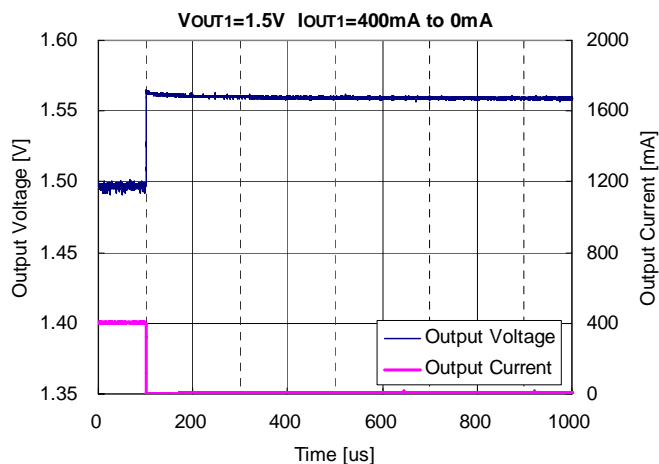
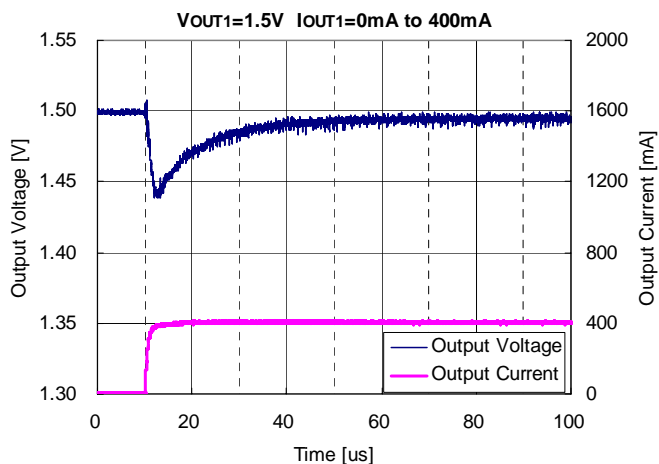



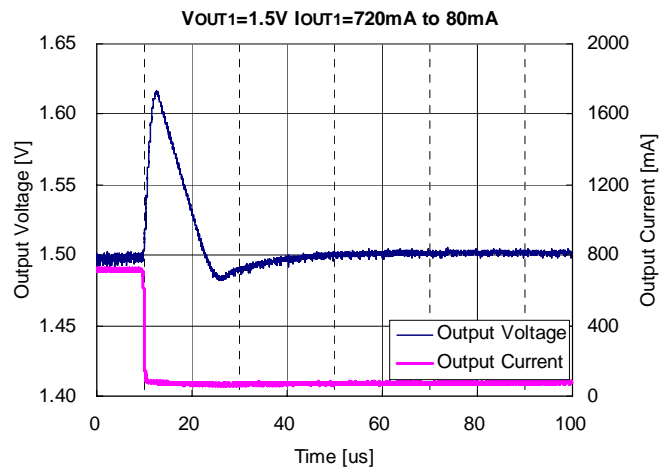
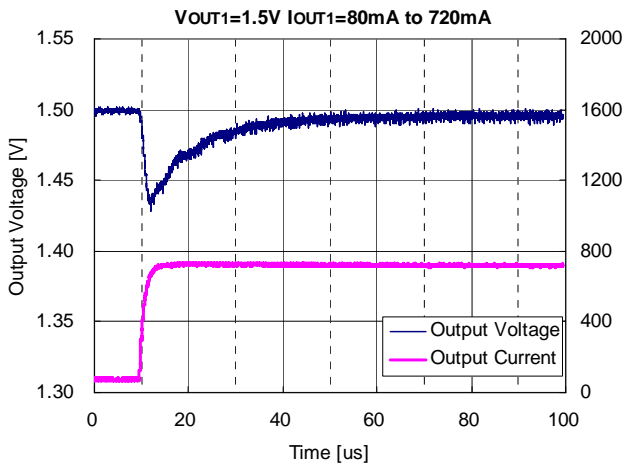

**B Version V<sub>OUT1</sub>=1.5V**

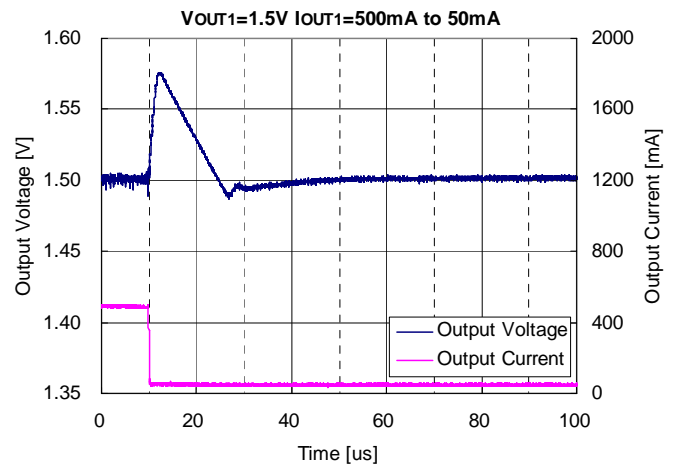
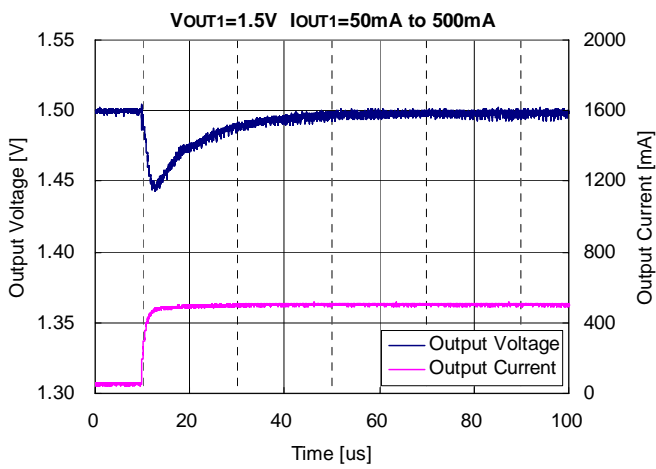
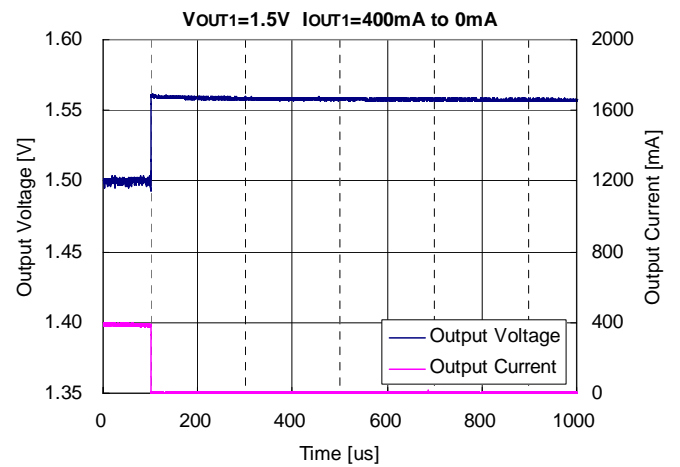
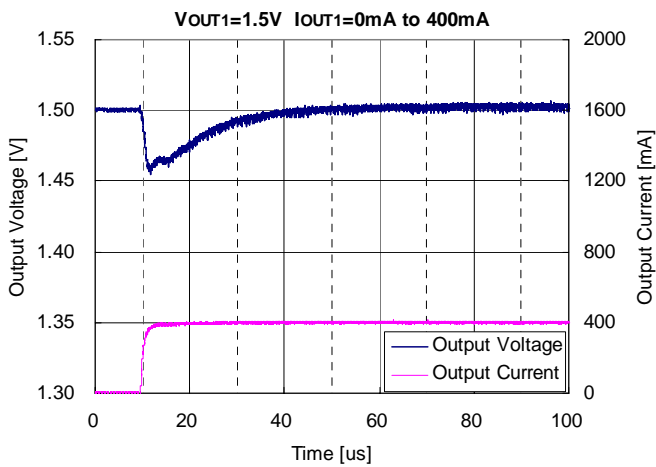

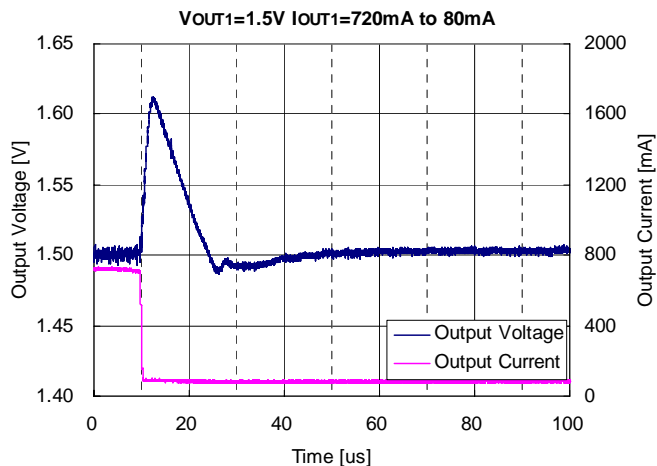
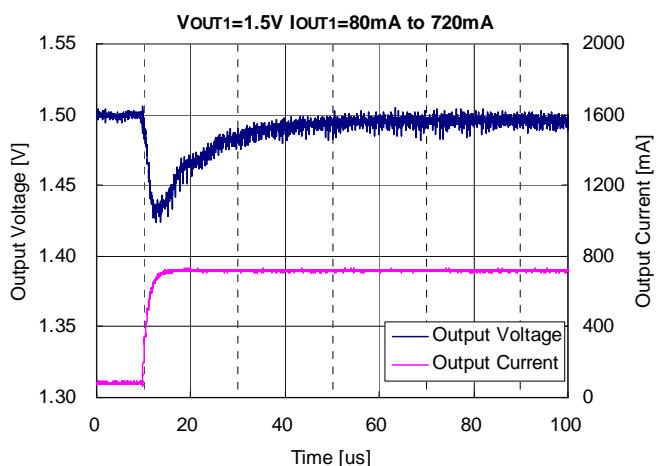

**24) VR Load transient response (DC/DC load current comparison)**  
**(C<sub>IN</sub>=Ceramic 10uF, C<sub>OUT2</sub>= Ceramic 2.2uF, VDD=5.0V)**

**DC/DC load current IOUT2=0mA**

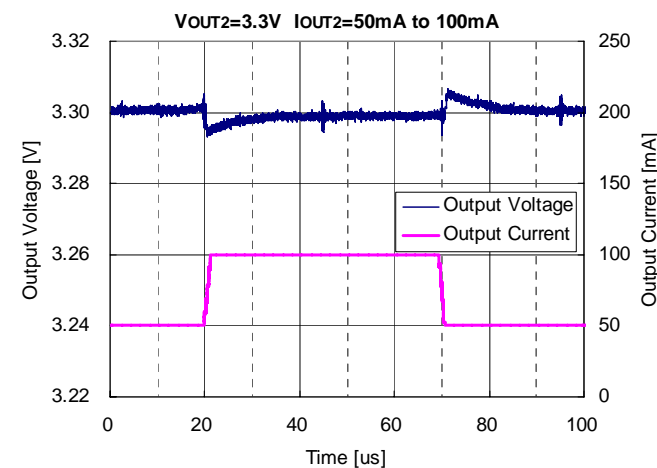
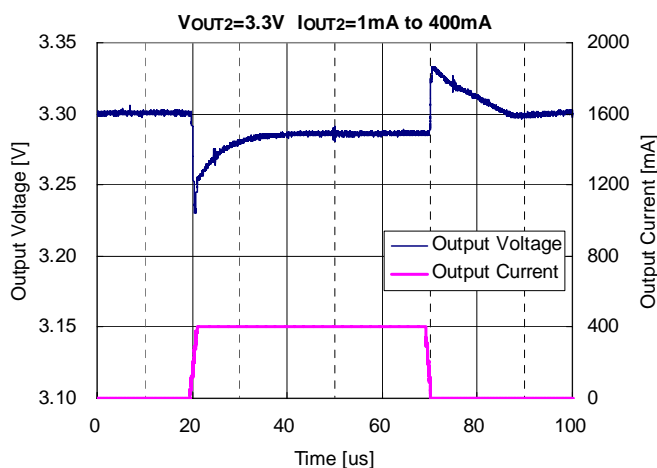

**DC/DC load current IOUT2=400mA**

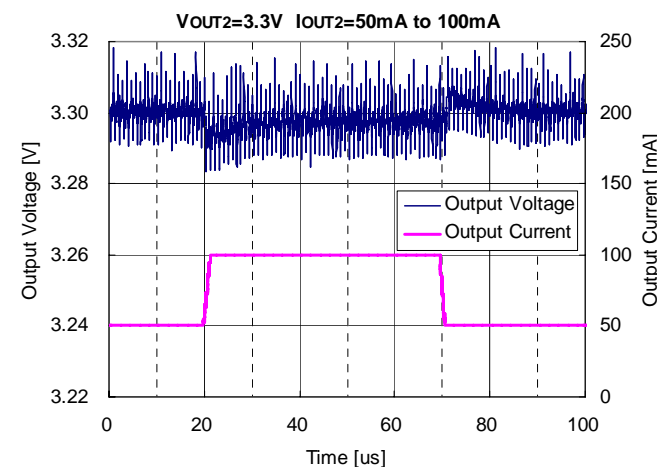
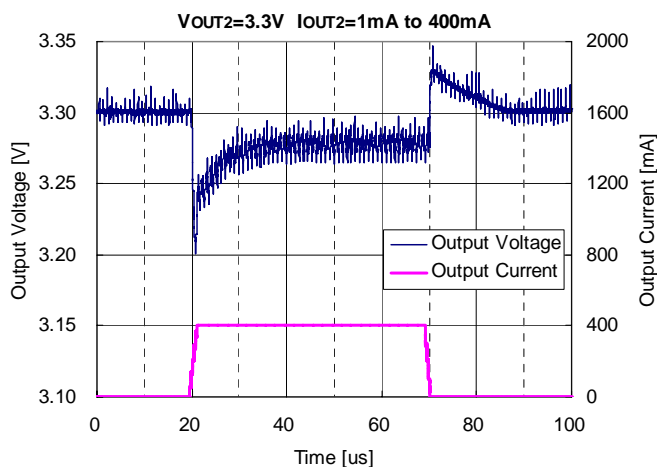

## POWER DISSIPATION-(1) / DFN(PLP)2527-10

DFN(PLP)2527-10 package power dissipation characteristic is shown below.

The power dissipation depends on the conditions of the mounting on PCB and this is just an example.

Test conditions

Standard Mounting on Board Condition	
Test Condition	Mounting on board (Wind velocity 0m/s)
Board material	Glass Epoxy Resin (4-layer)
Board dimensions	35mm x 90mm x 0.8mm
Wiring ratio	Each layer 15%
Copper wire thickness	Top/Bottom layer: 35 $\mu$ m, Middle layer: 18 $\mu$ m
Through holes	9( $\phi$ 0.3mm) package tab connection land pattern, from top to bottom 10 ( $\phi$ 0.5mm) for each pin connection

Measurement result

(Ta=25°C)

Standard Mounting on Board Conditions	
Power Dissipation	1400mW (Tjmax=125°C) 1750mW (Tjmax=150°C)
Thermal Resistance	$\theta_{ja} = (125-25^\circ\text{C}) / 1.4\text{W} = 71^\circ\text{C} / \text{W}$

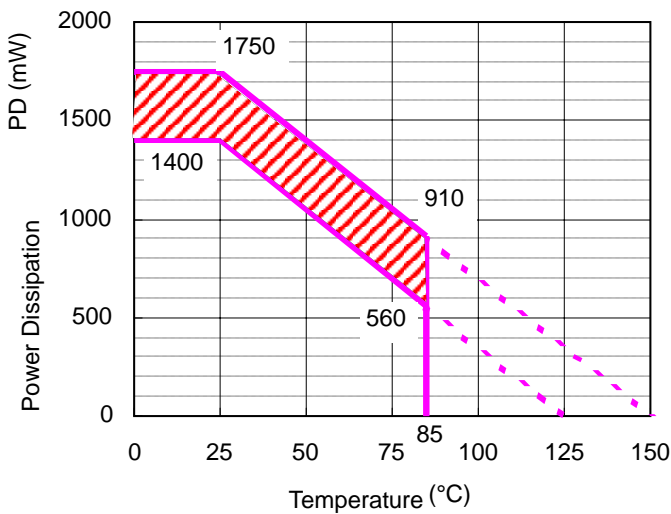

Power Dissipation Characteristic

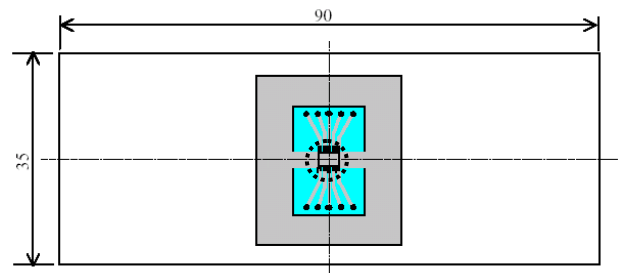

Test board layout



IC mount position (Unit : mm)

\* The hatched area usage has some impact on the product life time. The time for the usage of the hatched area should be less than 13,000 hours. If four hours a day, the product is used, the time limit is 9 years.

## POWER DISSIPATION-(2) / DFN(PLP)2527-10

DFN(PLP)2527-10 package another typical characteristic is shown below.

### Test Conditions

Mounting on Board Conditions (2)	
Test condition	Mounting on Board (Wind Velocity 0m/s)
Board material	Glass Epoxy Resin (Printed on both sides)
Board dimensions	40mm × 40mm × 1.6mm
Wiring ratio	Top side 50%, Bottom side 50%
Through holes	Diameter 0.54mm × 30 pcs

### Measurement result

(Ta=25°C)

Mounting on Board Conditions (2)	
Power dissipation	910mW (Tjmax=125°C) 1138mW (Tjmax=150°C)
Thermal resistance	$\theta_{ja} = (125-25^\circ\text{C}) / 0.91\text{W} = 110^\circ\text{C} / \text{W}$

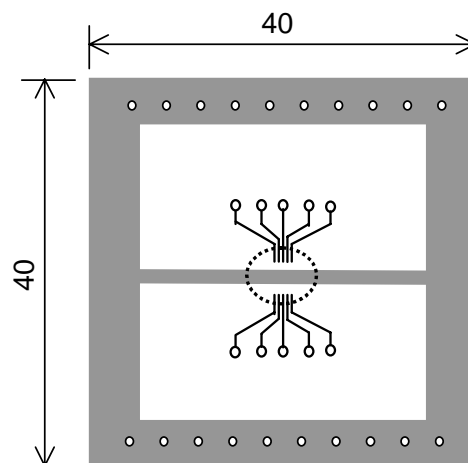
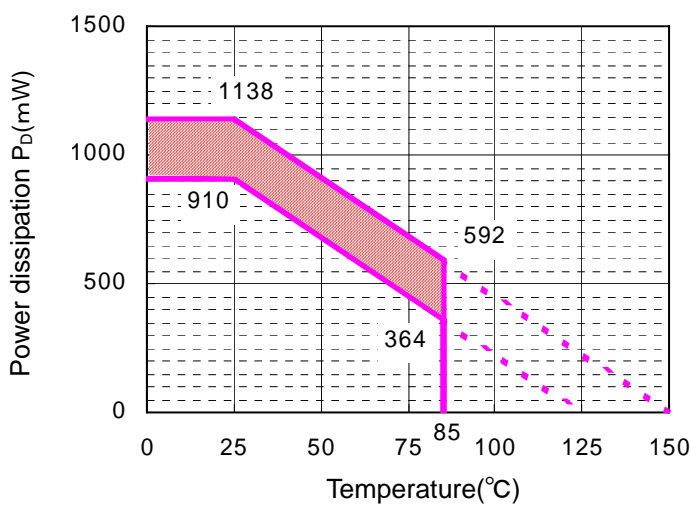

Test Board Layout

Power Dissipation Characteristic

IC mount position (Unit: mm)

\*Tjmax=125°C and Tjmax=150°C Power dissipation characteristics are shown in the graph. The hatched area usage has some impact on the product lifetime. Time limit is described in the next table.

Time limit	Product life time (4hours/day usage)
13,000 hrs	9 years



1. The products and the product specifications described in this document are subject to change or discontinuation of production without notice for reasons such as improvement. Therefore, before deciding to use the products, please refer to Ricoh sales representatives for the latest information thereon.
2. The materials in this document may not be copied or otherwise reproduced in whole or in part without prior written consent of Ricoh.
3. Please be sure to take any necessary formalities under relevant laws or regulations before exporting or otherwise taking out of your country the products or the technical information described herein.
4. The technical information described in this document shows typical characteristics of and example application circuits for the products. The release of such information is not to be construed as a warranty of or a grant of license under Ricoh's or any third party's intellectual property rights or any other rights.
5. The products listed in this document are intended and designed for use as general electronic components in standard applications (office equipment, telecommunication equipment, measuring instruments, consumer electronic products, amusement equipment etc.). Those customers intending to use a product in an application requiring extreme quality and reliability, for example, in a highly specific application where the failure or misoperation of the product could result in human injury or death (aircraft, spacevehicle, nuclear reactor control system, traffic control system, automotive and transportation equipment, combustion equipment, safety devices, life support system etc.) should first contact us.
6. We are making our continuous effort to improve the quality and reliability of our products, but semiconductor products are likely to fail with certain probability. In order to prevent any injury to persons or damages to property resulting from such failure, customers should be careful enough to incorporate safety measures in their design, such as redundancy feature, fire containment feature and fail-safe feature. We do not assume any liability or responsibility for any loss or damage arising from misuse or inappropriate use of the products.
7. Anti-radiation design is not implemented in the products described in this document.
8. Please contact Ricoh sales representatives should you have any questions or comments concerning the products or the technical information.



**Ricoh is committed to reducing the environmental loading materials in electrical devices with a view to contributing to the protection of human health and the environment.**

Ricoh has been providing RoHS compliant products since April 1, 2006 and Halogen-free products since April 1, 2012.

**RICOH** RICOH ELECTRONIC DEVICES CO., LTD.

<http://www.e-devices.ricoh.co.jp/en/>

#### Sales & Support Offices

##### **RICOH ELECTRONIC DEVICES CO., LTD.**

**Higashi-Shinagawa Office (International Sales)**  
3-32-3, Higashi-Shinagawa, Shinagawa-ku, Tokyo 140-8655, Japan  
Phone: +81-3-5479-2857 Fax: +81-3-5479-0502

##### **RICOH EUROPE (NETHERLANDS) B.V.**

**Semiconductor Support Centre**  
Prof. W.H. Keesomlaan 1, 1183 DJ Amstelveen, The Netherlands  
Phone: +31-20-5474-309

##### **RICOH ELECTRONIC DEVICES KOREA CO., LTD.**

3F, Haesung Bldg. 504, Teheran-ro, Gangnam-gu, Seoul, 135-725, Korea  
Phone: +82-2-2135-5700 Fax: +82-2-2051-5713

##### **RICOH ELECTRONIC DEVICES SHANGHAI CO., LTD.**

Room 403, No.2 Building, No.690 Bilbo Road, Pu Dong New District, Shanghai 201203,  
People's Republic of China  
Phone: +86-21-5027-3200 Fax: +86-21-5027-3299

##### **RICOH ELECTRONIC DEVICES CO., LTD.**

**Taipei office**  
Room 109, 10F-1, No.51, Hengyang Rd., Taipei City, Taiwan (R.O.C.)  
Phone: +886-2-2313-1621/1622 Fax: +886-2-2313-1623

# Mouser Electronics

Authorized Distributor

Click to View Pricing, Inventory, Delivery & Lifecycle Information:

[RicoH Electronics:](#)

[RP901K001C-TR](#) [RP901K012D-TR](#) [RP901K010D-TR](#)

Компания «Океан Электроники» предлагает заключение долгосрочных отношений при поставках импортных электронных компонентов на взаимовыгодных условиях!

Наши преимущества:

- Поставка оригинальных импортных электронных компонентов напрямую с производств Америки, Европы и Азии, а так же с крупнейших складов мира;
- Широкая линейка поставок активных и пассивных импортных электронных компонентов (более 30 млн. наименований);
- Поставка сложных, дефицитных, либо снятых с производства позиций;
- Оперативные сроки поставки под заказ (от 5 рабочих дней);
- Экспресс доставка в любую точку России;
- Помощь Конструкторского Отдела и консультации квалифицированных инженеров;
- Техническая поддержка проекта, помощь в подборе аналогов, поставка прототипов;
- Поставка электронных компонентов под контролем ВП;
- Система менеджмента качества сертифицирована по Международному стандарту ISO 9001;
- При необходимости вся продукция военного и аэрокосмического назначения проходит испытания и сертификацию в лаборатории (по согласованию с заказчиком);
- Поставка специализированных компонентов военного и аэрокосмического уровня качества (Xilinx, Altera, Analog Devices, Intersil, Interpoint, Microsemi, Actel, Aeroflex, Peregrine, VPT, Syfer, Eurofarad, Texas Instruments, MS Kennedy, Miteq, Cobham, E2V, MA-COM, Hittite, Mini-Circuits, General Dynamics и др.);

Компания «Океан Электроники» является официальным дистрибьютором и эксклюзивным представителем в России одного из крупнейших производителей разъемов военного и аэрокосмического назначения «JONHON», а так же официальным дистрибьютором и эксклюзивным представителем в России производителя высокотехнологичных и надежных решений для передачи СВЧ сигналов «FORSTAR».



## JONHON

«JONHON» (основан в 1970 г.)

Разъемы специального, военного и аэрокосмического назначения:

(Применяются в военной, авиационной, аэрокосмической, морской, железнодорожной, горно- и нефтедобывающей отраслях промышленности)

«FORSTAR» (основан в 1998 г.)

ВЧ соединители, коаксиальные кабели, кабельные сборки и микроволновые компоненты:

(Применяются в телекоммуникациях гражданского и специального назначения, в средствах связи, РЛС, а так же военной, авиационной и аэрокосмической отраслях промышленности).



Телефон: 8 (812) 309-75-97 (многоканальный)

Факс: 8 (812) 320-03-32

Электронная почта: [ocean@oceanchips.ru](mailto:ocean@oceanchips.ru)

Web: <http://oceanchips.ru/>

Адрес: 198099, г. Санкт-Петербург, ул. Калинина, д. 2, корп. 4, лит. А