

Diode

Rapid Switching Emitter Controlled Diode

IDW15E65D2

Emitter Controlled Diode

Data sheet

Industrial Power Control

Rapid Switching Emitter Controlled Diode

Features:

- Qualified according to JEDEC for target applications
- 650 V Emitter Controlled technology
- Fast recovery
- Soft switching
- Low reverse recovery charge
- Low forward voltage and stable over temperature
- 175 °C junction operating temperature
- Easy paralleling
- Pb-free lead plating; RoHS compliant

Applications:

- Boost diode in CCM PFC

Package pin definition:

- Pin 1 - not connected
- Pin 2 - cathode
- Pin 3 - anode

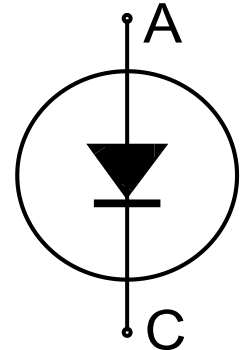

Key Performance and Package Parameters

Type	V_{rrm}	I_f	$V_f, T_{vj}=25^{\circ}\text{C}$	T_{vjmax}	Marking	Package
IDW15E65D2	650V	15A	1.6V	175°C	E15ED2	PG-TO247-3



Table of Contents

Description 2

Table of Contents 3

Maximum Ratings 4

Thermal Resistance 4

Electrical Characteristics 4

Electrical Characteristics Diagrams 6

Package Drawing 8

Testing Conditions 9

Revision History 10

Disclaimer 10

Emitter Controlled Diode

Maximum Ratings

For optimum lifetime and reliability, Infineon recommends operating conditions that do not exceed 80% of the maximum ratings stated in this datasheet.

Parameter	Symbol	Value	Unit
Repetitive peak reverse voltage	V_{RRM}	650	V
Diode forward current, limited by T_{vjmax} $T_C = 25^\circ\text{C}$ $T_C = 100^\circ\text{C}$	I_F	30.0 15.0	A
Diode pulsed current, t_p limited by T_{vjmax}	I_{Fpuls}	45.0	A
Diode surge non repetitive forward current $T_C = 25^\circ\text{C}$, $t_p = 8.3\text{ms}$, sine halfwave	I_{FSM}	100.0	A
Power dissipation $T_C = 25^\circ\text{C}$	P_{tot}	85.7	W
Operating junction temperature	T_{vj}	-40...+175	$^\circ\text{C}$
Storage temperature	T_{stg}	-55...+150	$^\circ\text{C}$
Soldering temperature, wave soldering 1.6 mm (0.063 in.) from case for 10s		260	$^\circ\text{C}$
Mounting torque, M3 screw Maximum of mounting processes: 3	M	0.6	Nm

Thermal Resistance

Parameter	Symbol	Conditions	Max. Value	Unit
Characteristic				
Diode thermal resistance, ¹⁾ junction - case	$R_{th(j-c)}$		1.75	K/W
Thermal resistance junction - ambient	$R_{th(j-a)}$		40	K/W

Electrical Characteristic, at $T_{vj} = 25^\circ\text{C}$, unless otherwise specified

Parameter	Symbol	Conditions	Value			Unit
			min.	typ.	max.	
Static Characteristic						
Diode forward voltage	V_F	$I_F = 15.0\text{A}$ $T_{vj} = 25^\circ\text{C}$ $T_{vj} = 175^\circ\text{C}$	- -	1.60 1.65	2.20 -	V
Reverse leakage current	I_R	$V_R = 650\text{V}$ $T_{vj} = 25^\circ\text{C}$ $T_{vj} = 175^\circ\text{C}$	- -	- -	40.0 4000.0	μA

Electrical Characteristic, at $T_{vj} = 25^\circ\text{C}$, unless otherwise specified

Parameter	Symbol	Conditions	Value			Unit
			min.	typ.	max.	
Dynamic Characteristic						
Internal emitter inductance measured 5mm (0.197 in.) from case	L_E		-	13.0	-	nH

¹⁾ Please be aware that in non standard load conditions, due to high $R_{th(j-c)}$, T_{vj} close to T_{vjmax} can be reached.

Emitter Controlled Diode

Switching Characteristic, Inductive Load

Parameter	Symbol	Conditions	Value			Unit
			min.	typ.	max.	

Diode Characteristic, at $T_{vj} = 25^{\circ}\text{C}$

Diode reverse recovery time	t_{rr}	$T_{vj} = 25^{\circ}\text{C}$, $V_R = 400\text{V}$, $I_F = 15.0\text{A}$, $di_F/dt = 1000\text{A}/\mu\text{s}$, $L\sigma = 35\text{nH}$, $C\sigma = 32\text{pF}$, switch IPW60R045CP	-	30	-	ns
Diode reverse recovery charge	Q_{rr}		-	0.20	-	μC
Diode peak reverse recovery current	I_{rrm}		-	12.8	-	A
Diode peak rate of fall of reverse recovery current during t_b	di_{rr}/dt		-	-6500	-	$\text{A}/\mu\text{s}$
Diode reverse recovery time	t_{rr}	$T_{vj} = 25^{\circ}\text{C}$, $V_R = 400\text{V}$, $I_F = 15.0\text{A}$, $di_F/dt = 200\text{A}/\mu\text{s}$, $L\sigma = 35\text{nH}$, $C\sigma = 32\text{pF}$, switch IPW60R045CP	-	47	-	ns
Diode reverse recovery charge	Q_{rr}		-	0.12	-	μC
Diode peak reverse recovery current	I_{rrm}		-	3.3	-	A
Diode peak rate of fall of reverse recovery current during t_b	di_{rr}/dt		-	-1500	-	$\text{A}/\mu\text{s}$

Switching Characteristic, Inductive Load

Parameter	Symbol	Conditions	Value			Unit
			min.	typ.	max.	

Diode Characteristic, at $T_{vj} = 175^{\circ}\text{C}/125^{\circ}\text{C}$

Diode reverse recovery time	t_{rr}	$T_{vj} = 175^{\circ}\text{C}$, $V_R = 400\text{V}$, $I_F = 15.0\text{A}$, $di_F/dt = 1000\text{A}/\mu\text{s}$, $L\sigma = 35\text{nH}$, $C\sigma = 32\text{pF}$, switch IPW60R045CP	-	30	-	ns
Diode reverse recovery charge	Q_{rr}		-	0.37	-	μC
Diode peak reverse recovery current	I_{rrm}		-	16.9	-	A
Diode peak rate of fall of reverse recovery current during t_b	di_{rr}/dt		-	-6800	-	$\text{A}/\mu\text{s}$
Diode reverse recovery time	t_{rr}	$T_{vj} = 125^{\circ}\text{C}$, $V_R = 400\text{V}$, $I_F = 15.0\text{A}$, $di_F/dt = 200\text{A}/\mu\text{s}$, $L\sigma = 35\text{nH}$, $C\sigma = 32\text{pF}$, switch IPW60R045CP	-	51	-	ns
Diode reverse recovery charge	Q_{rr}		-	0.21	-	μC
Diode peak reverse recovery current	I_{rrm}		-	5.0	-	A
Diode peak rate of fall of reverse recovery current during t_b	di_{rr}/dt		-	-1900	-	$\text{A}/\mu\text{s}$

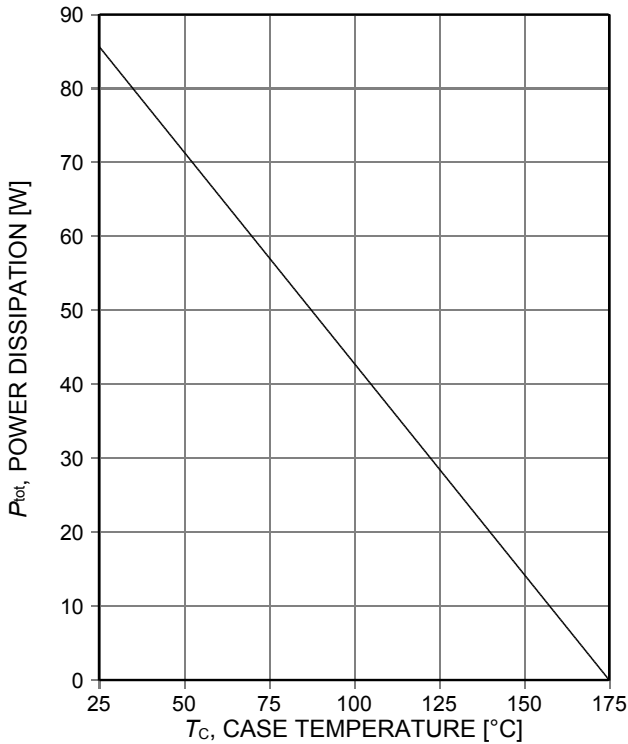

Figure 1. Power dissipation as a function of case temperature ($T_{vj} \leq 175^\circ\text{C}$)

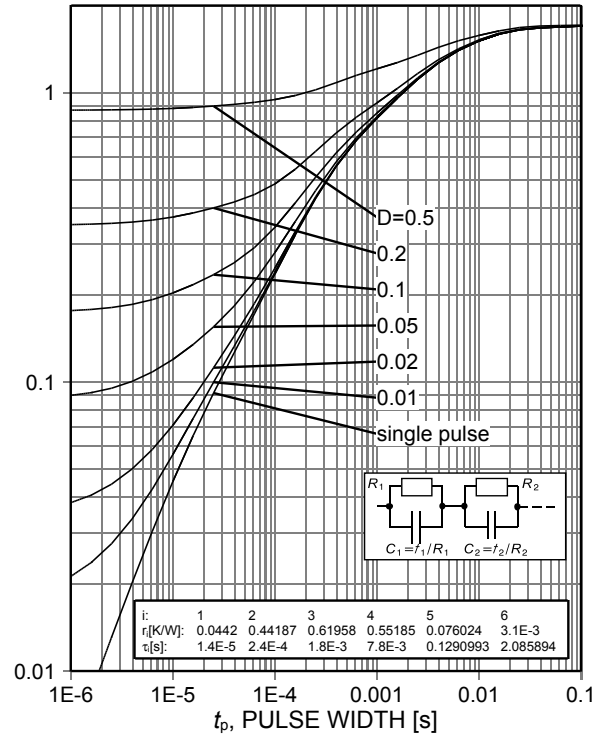

Figure 2. Diode transient thermal impedance as a function of pulse width ($D = t_p/T$)

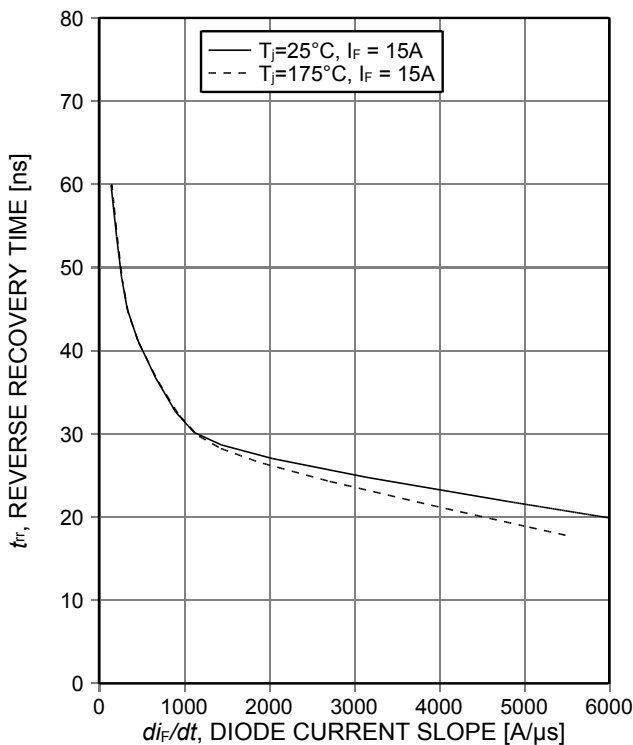

Figure 3. Typical reverse recovery time as a function of diode current slope ($V_R=400\text{V}$)

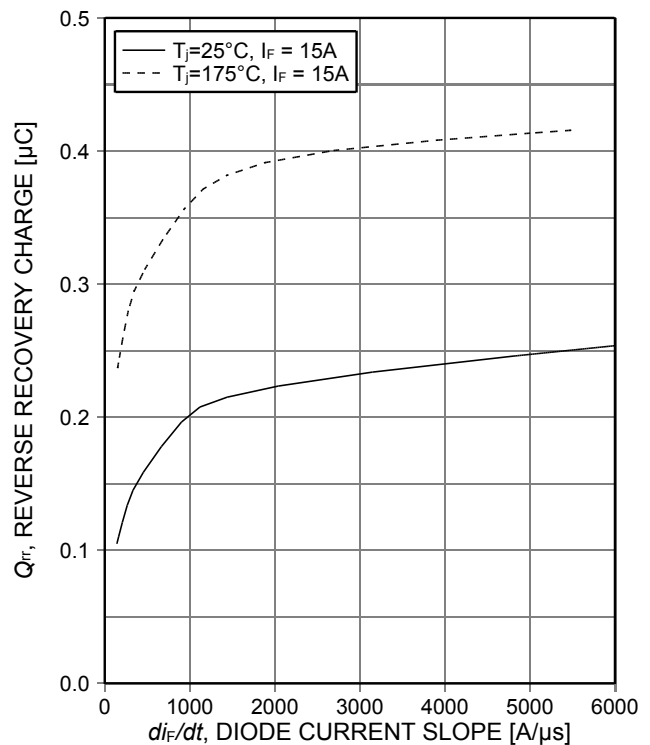

Figure 4. Typical reverse recovery charge as a function of diode current slope ($V_R=400\text{V}$)

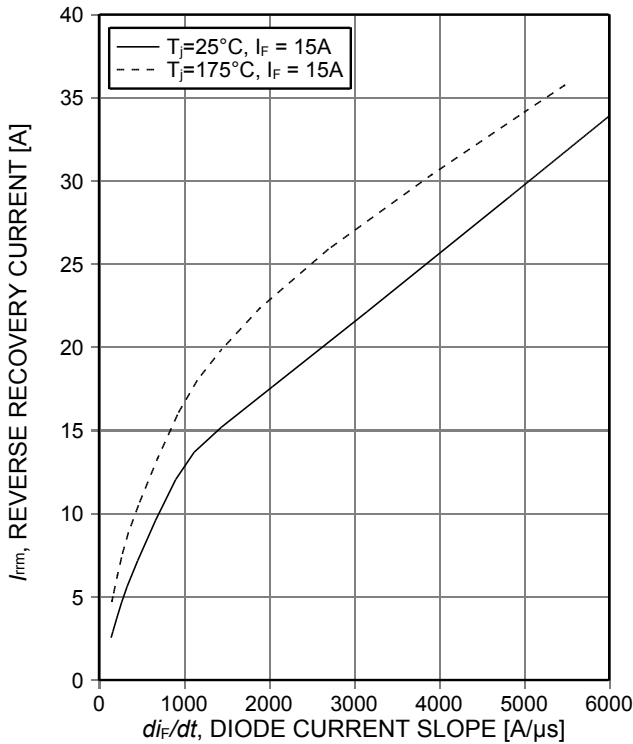

Figure 5. Typical peak reverse recovery current as a function of diode current slope ($V_R=400V$)

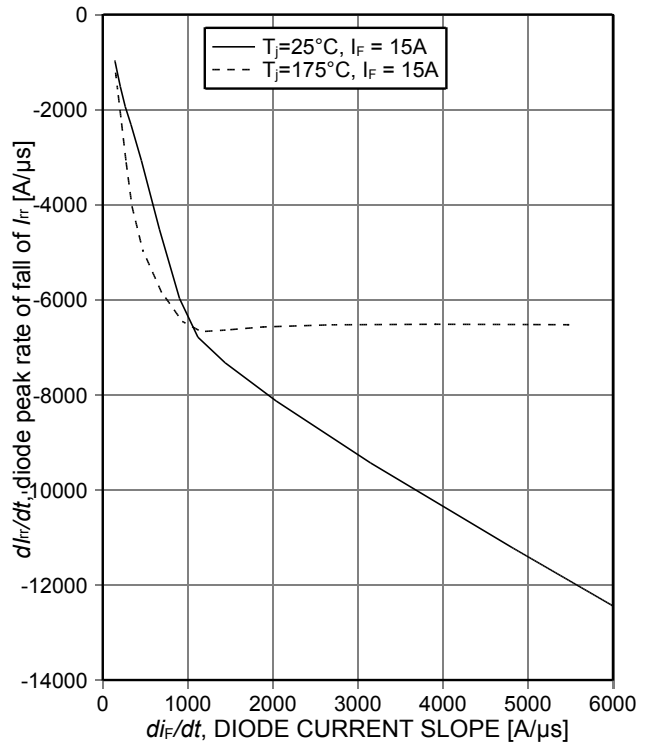

Figure 6. Typical diode peak rate of fall of reverse recovery current as a function of diode current slope ($V_R=400V$)

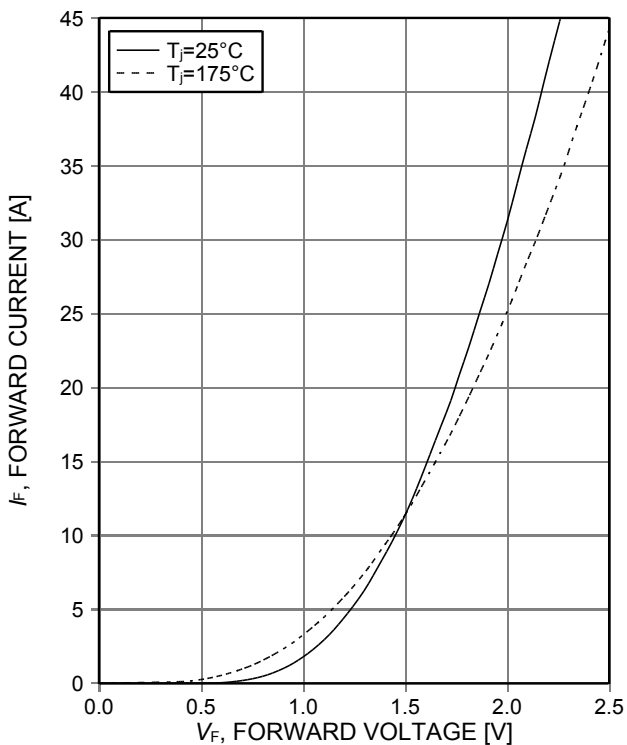

Figure 7. Typical diode forward current as a function of forward voltage

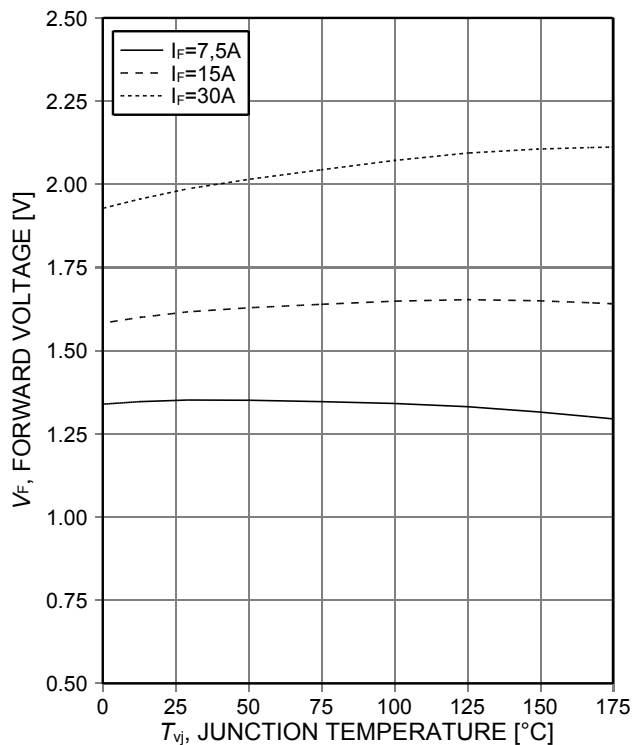
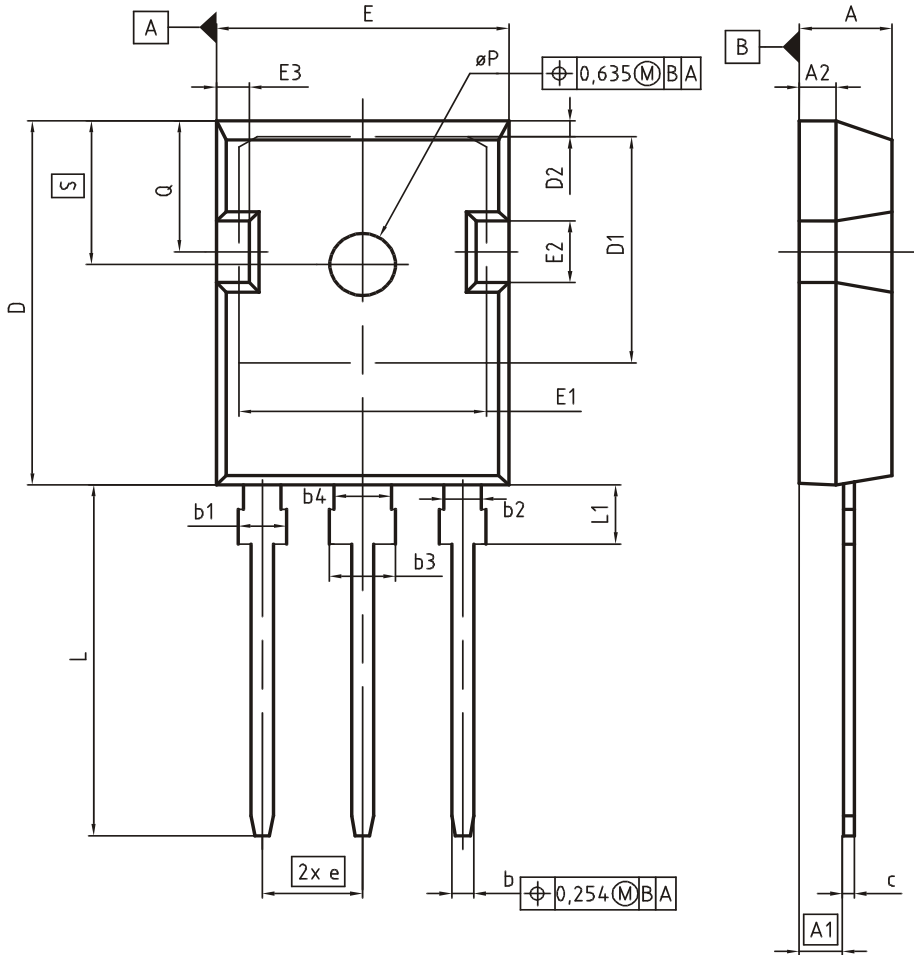

Figure 8. Typical diode forward voltage as a function of junction temperature

PG-TO247-3



DIM	MILLIMETERS		INCHES	
	MIN	MAX	MIN	MAX
A	4.83	5.21	0.190	0.205
A1	2.27	2.54	0.089	0.100
A2	1.85	2.16	0.073	0.085
b	1.07	1.33	0.042	0.052
b1	1.90	2.41	0.075	0.095
b2	1.90	2.16	0.075	0.085
b3	2.87	3.38	0.113	0.133
b4	2.87	3.13	0.113	0.123
c	0.55	0.68	0.022	0.027
D	20.80	21.10	0.819	0.831
D1	16.25	17.65	0.640	0.695
D2	0.95	1.35	0.037	0.053
E	15.70	16.13	0.618	0.635
E1	13.10	14.15	0.516	0.557
E2	3.68	5.10	0.145	0.201
E3	1.00	2.60	0.039	0.102
e	5.44 (BSC)		0.214 (BSC)	
N	3		3	
L	19.80	20.32	0.780	0.800
L1	4.10	4.47	0.161	0.176
øP	3.50	3.70	0.138	0.146
Q	5.49	6.00	0.216	0.236
S	6.04	6.30	0.238	0.248

DOCUMENT NO.
Z8B00003327

SCALE

EUROPEAN PROJECTION

ISSUE DATE
09-07-2010

REVISION
05



Figure A. Definition of switching times



Figure B. Definition of switching losses

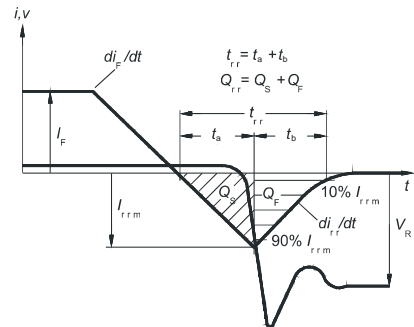

Figure C. Definition of diodes switching characteristics



Figure D. Thermal equivalent circuit

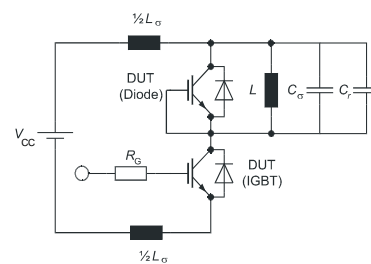

Figure E. Dynamic test circuit
Parasitic inductance L_σ ,
Parasitic capacitor C_σ ,
Relief capacitor C_r
(only for ZVT switching)

Revision History

IDW15E65D2

Revision: 2014-08-26, Rev. 2.2

Previous Revision

Revision	Date	Subjects (major changes since last revision)
1.1	2013-03-13	Preliminary data sheet
2.1	2013-12-16	Final DS / New Marking Pattern
2.2	2014-08-26	VFmax limit reduced according BE test and Qrr at 25°C corrected

We Listen to Your Comments

Any information within this document that you feel is wrong, unclear or missing at all ?

Your feedback will help us to continuously improve the quality of this document.

Please send your proposal (including a reference to this document) to: erratum@infineon.com

Published by

Infineon Technologies AG

81726 Munich, Germany

81726 München, Germany

© 2014 Infineon Technologies AG

All Rights Reserved.

Legal Disclaimer

The information given in this document shall in no event be regarded as a guarantee of conditions or characteristics.

With respect to any examples or hints given herein, any typical values stated herein and/or any information regarding the application of the device, Infineon Technologies hereby disclaims any and all warranties and liabilities of any kind, including without limitation, warranties of non-infringement of intellectual property rights of any third party.

Information

For further information on technology, delivery terms and conditions and prices, please contact the nearest Infineon Technologies Office (www.infineon.com).

Warnings

Due to technical requirements, components may contain dangerous substances. For information on the types in question, please contact the nearest Infineon Technologies Office.

The Infineon Technologies component described in this Data Sheet may be used in life-support devices or systems and/or automotive, aviation and aerospace applications or systems only with the express written approval of Infineon Technologies, if a failure of such components can reasonably be expected to cause the failure of that life-support, automotive, aviation and aerospace device or system or to affect the safety or effectiveness of that device or system. Life support devices or systems are intended to be implanted in the human body or to support and/or maintain and sustain and/or protect human life. If they fail, it is reasonable to assume that the health of the user or other persons may be endangered.

Компания «Океан Электроники» предлагает заключение долгосрочных отношений при поставках импортных электронных компонентов на взаимовыгодных условиях!

Наши преимущества:

- Поставка оригинальных импортных электронных компонентов напрямую с производств Америки, Европы и Азии, а так же с крупнейших складов мира;
- Широкая линейка поставок активных и пассивных импортных электронных компонентов (более 30 млн. наименований);
- Поставка сложных, дефицитных, либо снятых с производства позиций;
- Оперативные сроки поставки под заказ (от 5 рабочих дней);
- Экспресс доставка в любую точку России;
- Помощь Конструкторского Отдела и консультации квалифицированных инженеров;
- Техническая поддержка проекта, помощь в подборе аналогов, поставка прототипов;
- Поставка электронных компонентов под контролем ВП;
- Система менеджмента качества сертифицирована по Международному стандарту ISO 9001;
- При необходимости вся продукция военного и аэрокосмического назначения проходит испытания и сертификацию в лаборатории (по согласованию с заказчиком);
- Поставка специализированных компонентов военного и аэрокосмического уровня качества (Xilinx, Altera, Analog Devices, Intersil, Interpoint, Microsemi, Actel, Aeroflex, Peregrine, VPT, Syfer, Eurofarad, Texas Instruments, MS Kennedy, Miteq, Cobham, E2V, MA-COM, Hittite, Mini-Circuits, General Dynamics и др.);

Компания «Океан Электроники» является официальным дистрибьютором и эксклюзивным представителем в России одного из крупнейших производителей разъемов военного и аэрокосмического назначения «**JONHON**», а так же официальным дистрибьютором и эксклюзивным представителем в России производителя высокотехнологичных и надежных решений для передачи СВЧ сигналов «**FORSTAR**».



JONHON

«**JONHON**» (основан в 1970 г.)

Разъемы специального, военного и аэрокосмического назначения:

(Применяются в военной, авиационной, аэрокосмической, морской, железнодорожной, горно- и нефтедобывающей отраслях промышленности)

«**FORSTAR**» (основан в 1998 г.)

ВЧ соединители, коаксиальные кабели,
кабельные сборки и микроволновые компоненты:

(Применяются в телекоммуникациях гражданского и специального назначения, в средствах связи, РЛС, а так же военной, авиационной и аэрокосмической отраслях промышленности).



Телефон: 8 (812) 309-75-97 (многоканальный)

Факс: 8 (812) 320-03-32

Электронная почта: ocean@oceanchips.ru

Web: <http://oceanchips.ru/>

Адрес: 198099, г. Санкт-Петербург, ул. Калинина, д. 2, корп. 4, лит. А