

# NGTB03N60R2DT4G



ON Semiconductor®

www.onsemi.com

## IGBT 600V, 4.5A, N-Channel

### Features

- Reverse Conducting II IGBT
- IGBT  $V_{CE(sat)}=1.7V$  (typ) [ $I_C=3A$ ,  $V_{GE}=15V$ ]
- IGBT  $t_f=75ns$  (typ)
- Diode  $V_F=1.5V$  (typ) [ $I_F=3A$ ]
- Diode  $t_{rr}=65ns$  (typ)
- 5 $\mu s$  Short Circuit Capability

### Applications

- General Purpose Inverter

### Specifications

**Absolute Maximum Ratings** at  $T_a=25^\circ C$ , Unless otherwise specified

Parameter	Symbol	Value	Unit	
Collector to Emitter Voltage	$V_{CES}$	600	V	
Gate to Emitter Voltage	$V_{GES}$	$\pm 20$	V	
Collector Current (DC)	$I_C$ *1	@ $T_c=25^\circ C$ *2	9	A
Limited by $T_{jmax}$		@ $T_c=100^\circ C$ *2	4.5	A
Collector Current (Peak)	$I_{CP}$	12	A	
Pulse width Limited by $T_{jmax}$				
Diode Average Output Current	$I_O$	4.5	A	
Power Dissipation	$P_D$	49	W	
$T_c=25^\circ C$ (Our ideal heat dissipation condition) *2				
Junction Temperature	$T_j$	175	$^\circ C$	
Storage Temperature	$T_{stg}$	-55 to +175	$^\circ C$	

Note : \*1 Collector Current is calculated from the following formula.

$$I_C(T_c) = \frac{T_{jmax} - T_c}{R_{th(j-c)} \times V_{CE(sat)}(I_C(T_c))}$$

\*2 Our condition is radiation from backside.

The method is applying silicone grease to the backside of the device and attaching the device to water-cooled radiator made of aluminum.

### Electrical Connection N-Channel

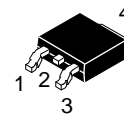
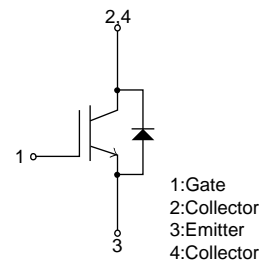

DPAK  
CASE 369C

### Marking Diagram

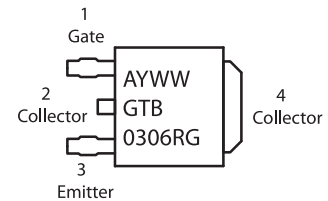

GTB0306R = Device Code  
A = Assembly Location  
Y = Year  
WW = Work Week  
G = Pb-Free Package

Stresses exceeding those listed in the Maximum Ratings table may damage the device. If any of these limits are exceeded, device functionality should not be assumed, damage may occur and reliability may be affected.

### ORDERING INFORMATION

See detailed ordering and shipping information on page 7 of this data sheet.

# NGTB03N60R2DT4G

## Electrical Characteristics at Ta=25°C, Unless otherwise specified

Parameter	Symbol	Conditions	Value			Unit
			min	typ	max	
Collector to Emitter Breakdown Voltage	V(BR)CES	IC=1mA, VGE=0V	600			V
Collector to Emitter Cut off Current	ICES	VCE=600V, VGE=0V	Tc=25°C		10	μA
			Tc=150°C		1	mA
Gate to Emitter Leakage Current	IGES	VGE=±20V, VCE=0V			±100	nA
Gate to Emitter Threshold Voltage	VGE(th)	VCE=20V, IC=80μA	4.5		7.0	V
Collector to Emitter Saturation Voltage	VCE(sat)	VGE=15V, IC=3A	Tc=25°C	1.7	2.1	V
			Tc=100°C	1.9	2.3	V
Forward Diode Voltage	VF	IF=3A		1.5	2.1	V
Input Capacitance	Cies	VCE=20V, f=1MHz		415		pF
Output Capacitance	Coes			17		pF
Reverse Transfer Capacitance	Cres			10		pF
Turn-ON Delay Time	t <sub>d(on)</sub>			27		ns
Rise Time	t <sub>r</sub>	VCC=300V, IC=3A RG=30Ω, L=500μH VGE=0V/15V Vclamp=400V Tc=25°C See Fig.1, See Fig.2		17		ns
Turn-ON Time	ton			85		ns
Turn-OFF Delay Time	t <sub>d(off)</sub>			59		ns
Fall Time	t <sub>f</sub>			75		ns
Turn-OFF Time	toff			172		ns
Turn-ON Energy	Eon			50		μJ
Turn-OFF Energy	Eoff			27		μJ
Total Gate Charge	Qg			17		nC
Gate to Emitter Charge	Qge	VCE=300V, VGE=15V, IC=3A		4.4		nC
Gate to Collector "Miller" Charge	Qgc			7.6		nC
Diode Reverse Recovery Time	t <sub>rr</sub>	IF=3A, di/dt=200A/μs, VCC=300V, See Fig.3		65		ns

Product parametric performance is indicated in the Electrical Characteristics for the listed test conditions, unless otherwise noted. Product performance may not be indicated by the Electrical Characteristics if operated under different conditions.

## Thermal Characteristics at Ta=25°C, Unless otherwise specified

Parameter	Symbol	Conditions	Value	Unit
Thermal Resistance IGBT (Junction to Case)	Rth(j-c) (IGBT)	Tc=25°C (Our ideal heat dissipation condition) *2	3.06	°C/W
Thermal Resistance (Junction to Ambient)	Rth(j-a)		100	°C/W

Note : \*2 Our condition is radiation from backside.

The method is applying silicone grease to the backside of the device and attaching the device to water-cooled radiator made of aluminum.

# NGTB03N60R2DT4G

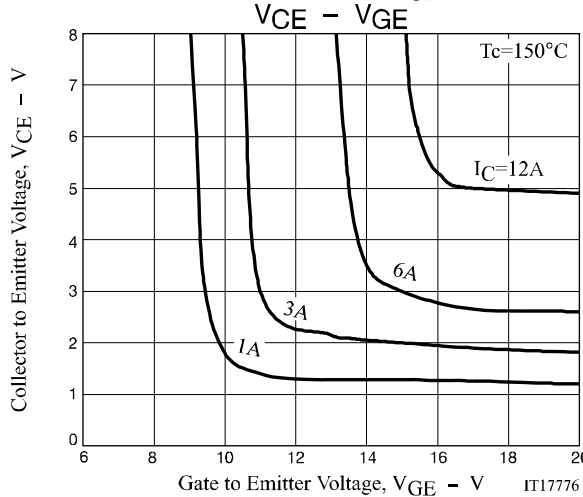
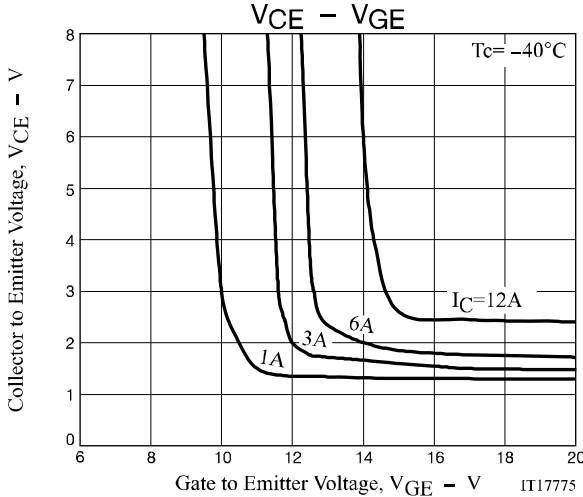
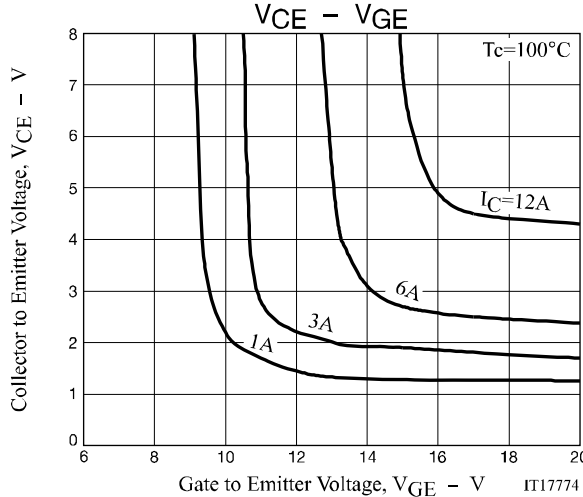
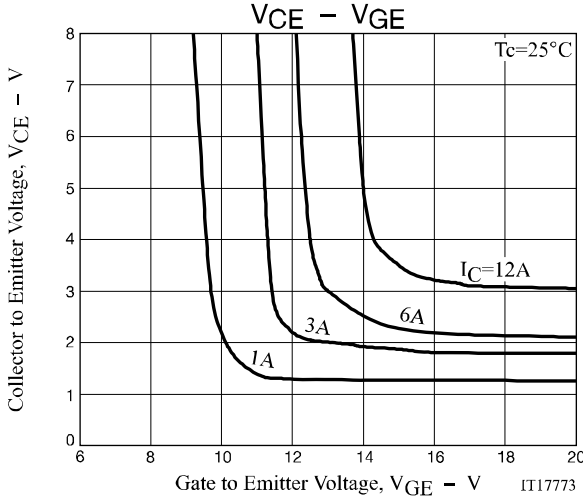
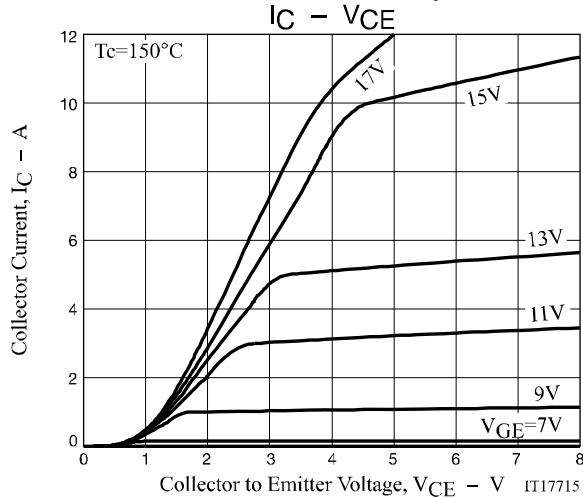
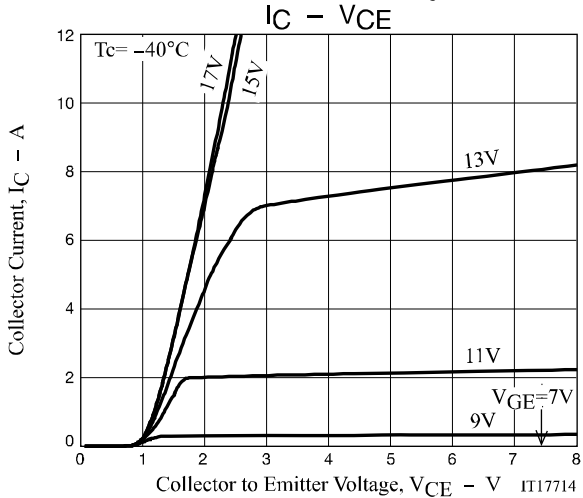
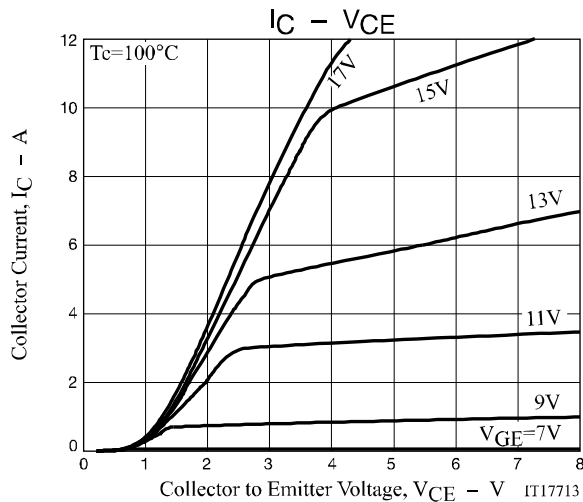
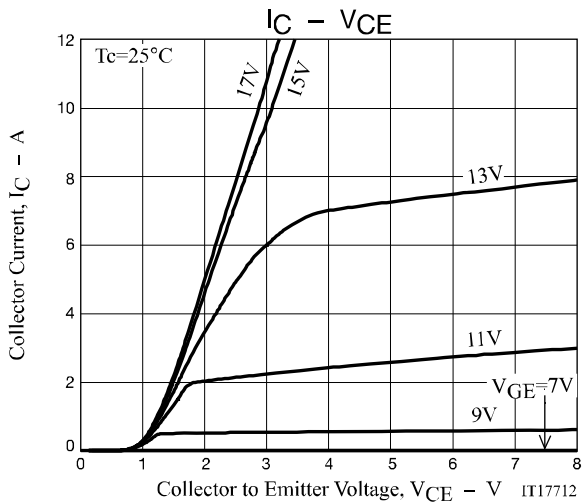

# NGTB03N60R2DT4G

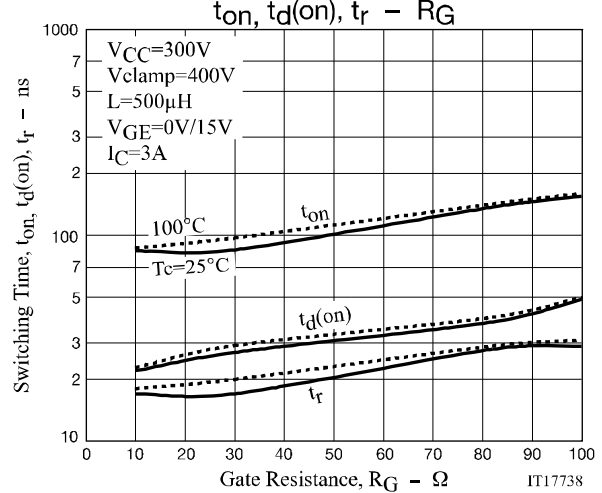
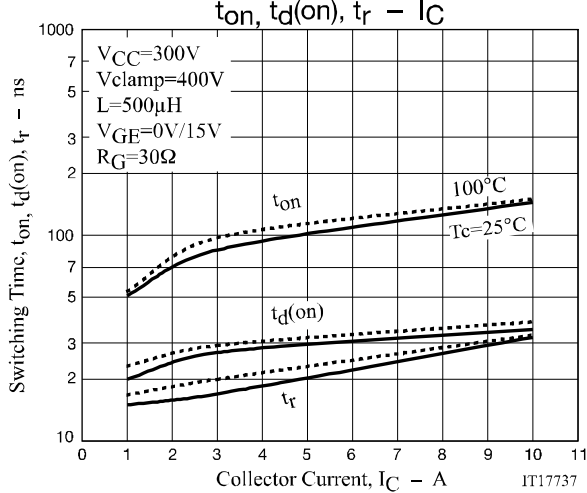
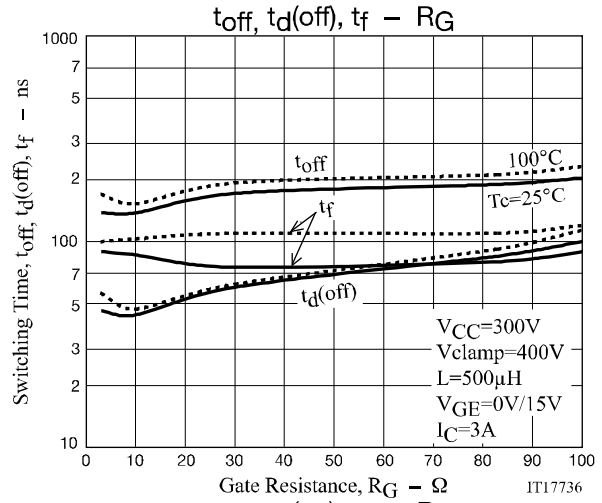
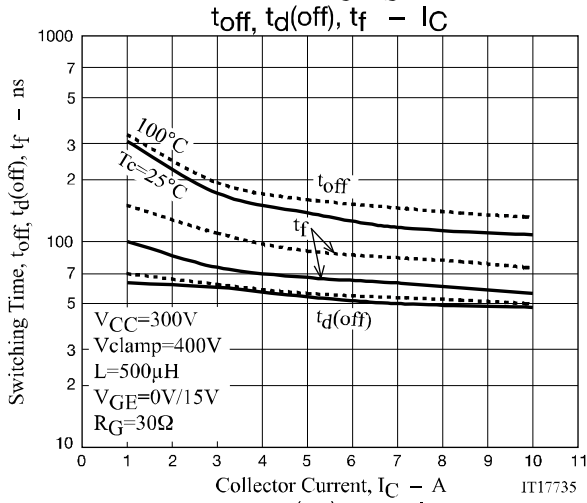
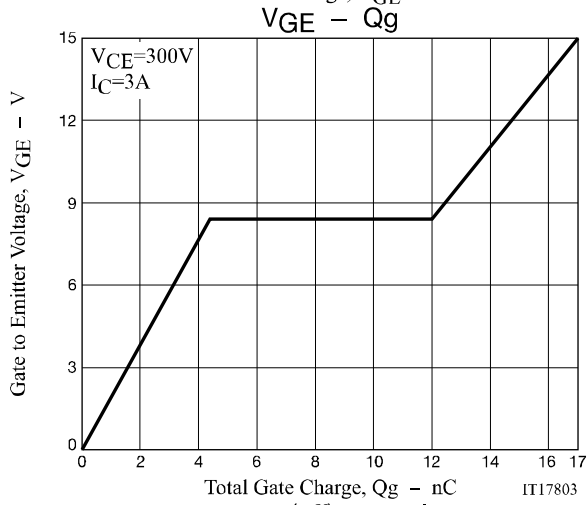
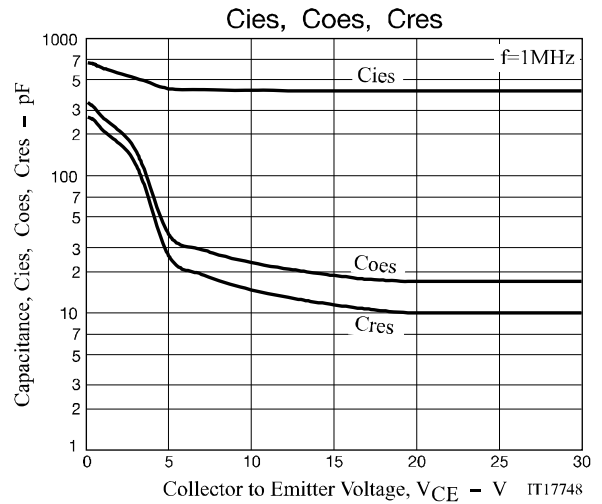
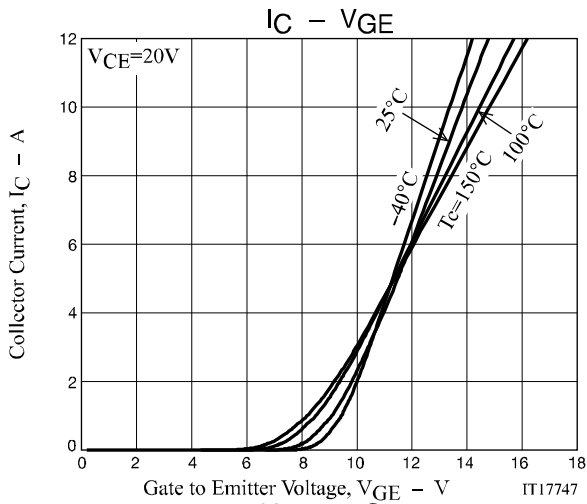

# NGTB03N60R2DT4G

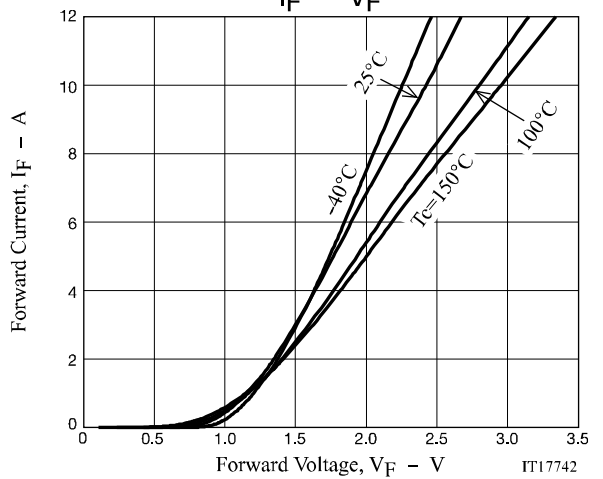
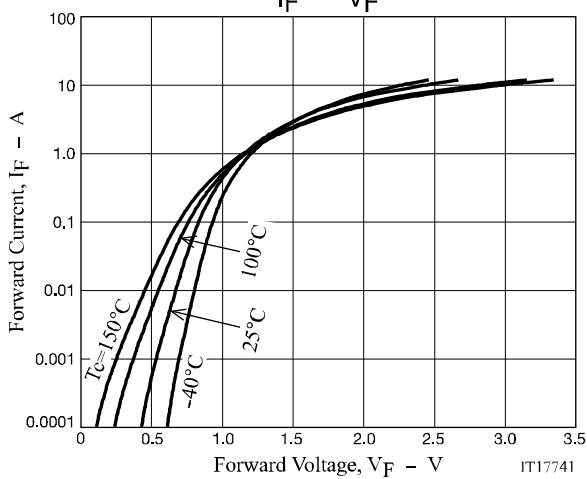
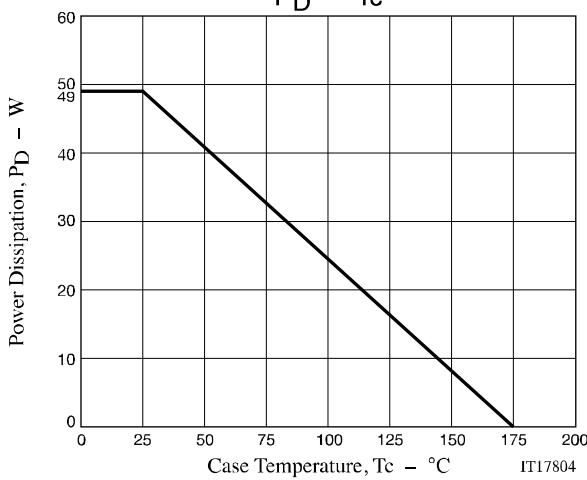
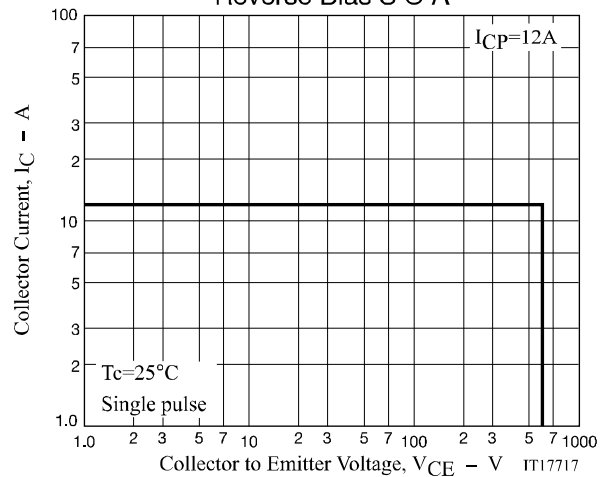
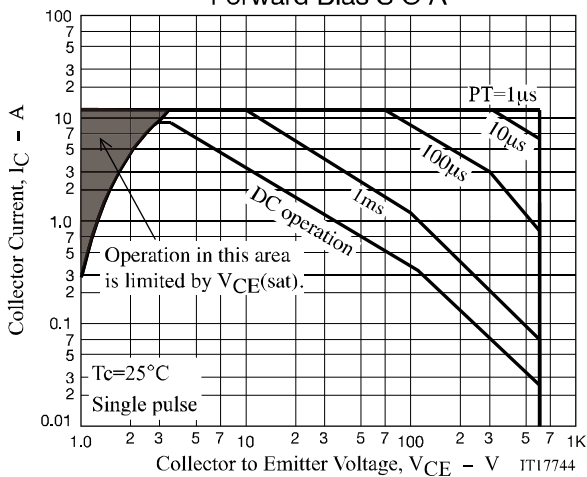
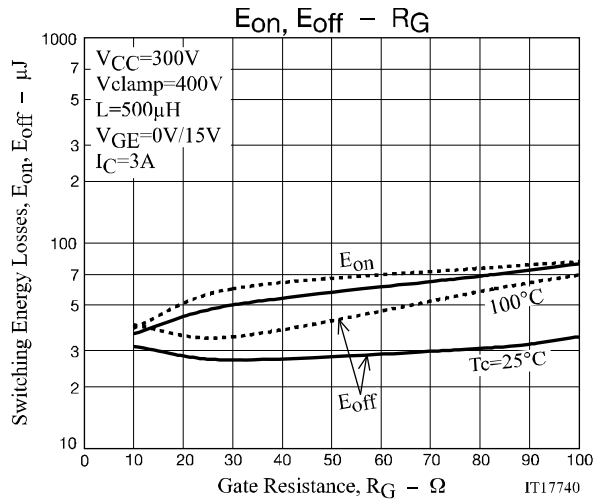
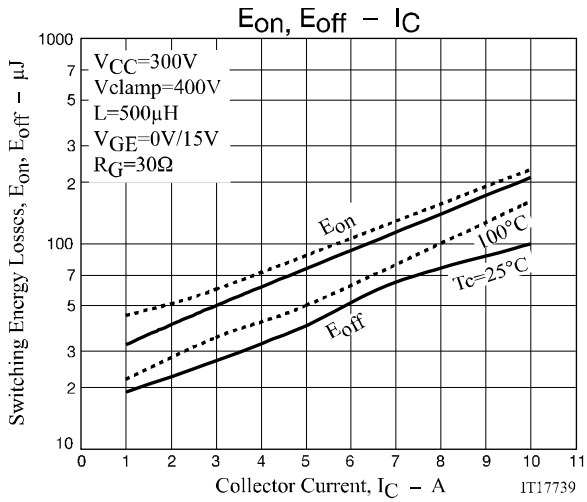

# NGTB03N60R2DT4G

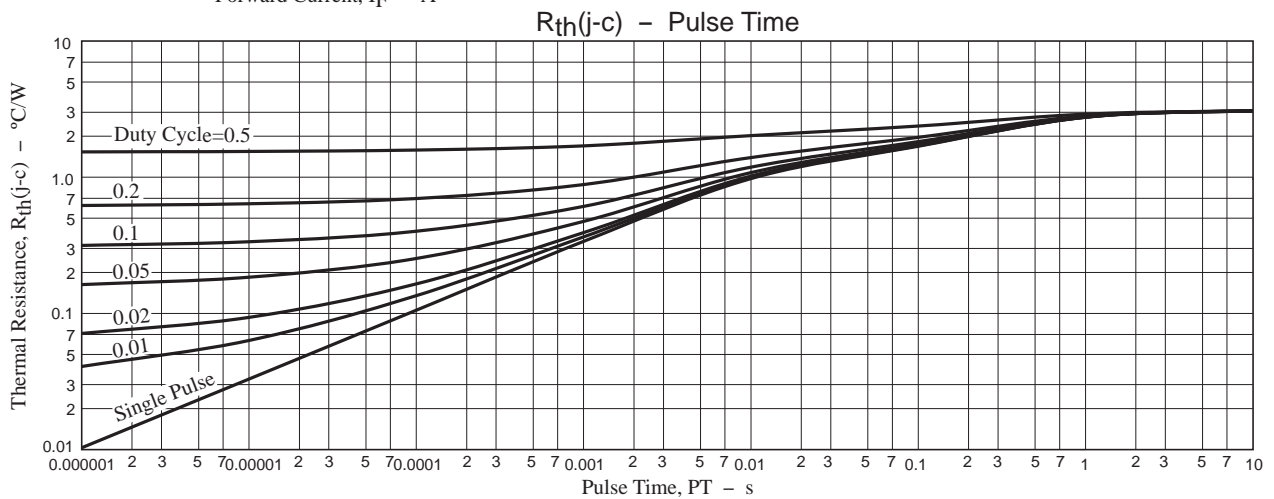
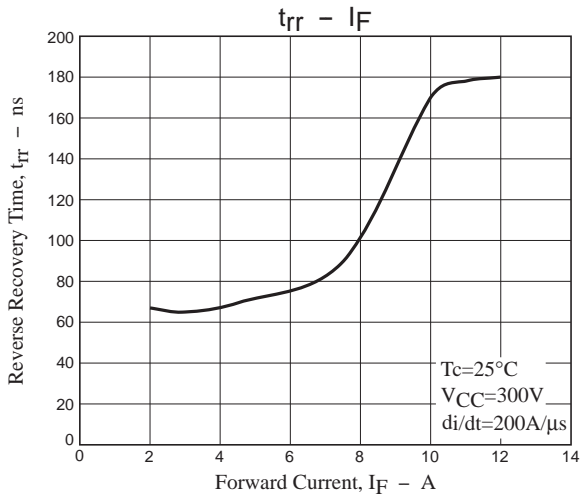

**Fig.1 Switching Time Test Circuit**

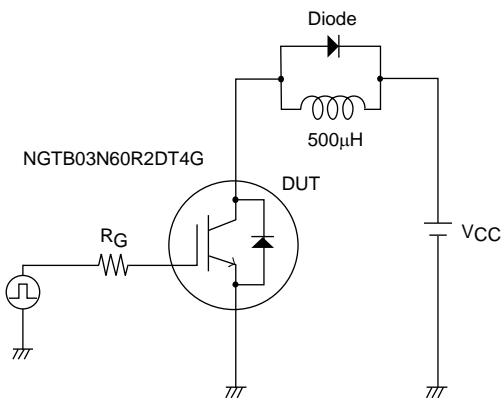

**Fig.2 Timing Chart**

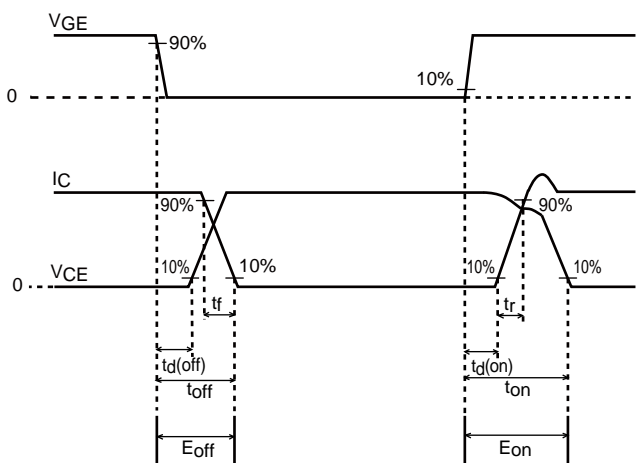

**Fig.3 Reverse Recovery Time Test Circuit**

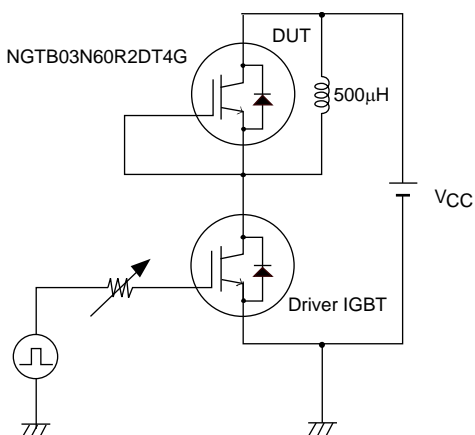

# NGTB03N60R2DT4G

## Package Dimensions

unit : mm

**DPAK (SINGLE GAUGE)**  
CASE 369C  
ISSUE E

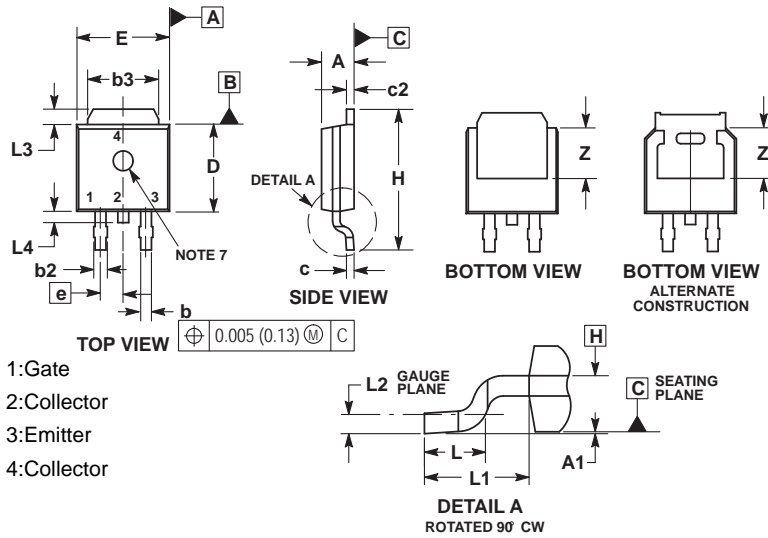

- |   |   |  |  |   |
|---|---|--|--|---|
| STYLE 1:<br>PIN 1. BASE<br>2. COLLECTOR<br>3. EMITTER<br>4. COLLECTOR | STYLE 2:<br>PIN 1. GATE<br>2. DRAIN<br>3. SOURCE<br>4. DRAIN          | STYLE 3:<br>PIN 1. ANODE<br>2. ANODE<br>3. ANODE<br>4. CATHODE | STYLE 4:<br>PIN 1. CATHODE<br>2. ANODE<br>3. GATE<br>4. ANODE              | STYLE 5:<br>PIN 1. GATE<br>2. ANODE<br>3. CATHODE<br>4. ANODE     |
| STYLE 6:<br>PIN 1. MT1<br>2. MT2<br>3. GATE<br>4. MT2                 | STYLE 7:<br>PIN 1. GATE<br>2. COLLECTOR<br>3. EMITTER<br>4. COLLECTOR | STYLE 8:<br>PIN 1. N/C<br>2. CATHODE<br>3. ANODE<br>4. CATHODE | STYLE 9:<br>PIN 1. ANODE<br>2. CATHODE<br>3. RESISTOR ADJUST<br>4. CATHODE | STYLE 10:<br>PIN 1. CATHODE<br>2. ANODE<br>3. CATHODE<br>4. ANODE |

### SOLDERING FOOTPRINT\*

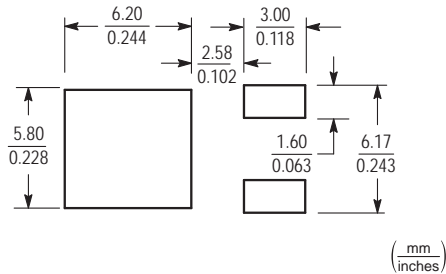

\*For additional information on our Pb-Free strategy and soldering details, please download the ON Semiconductor Soldering and Mounting Techniques Reference Manual, SOLDERRM/D.

### NOTES:

- DIMENSIONING AND TOLERANCING PER ASME Y14.5M, 1994.
- CONTROLLING DIMENSION: INCHES.
- THERMAL PAD CONTOUR OPTIONAL WITHIN DIMENSIONS b3, L3 and Z.
- DIMENSIONS D AND E DO NOT INCLUDE MOLD FLASH, PROTRUSIONS, OR BURRS. MOLD FLASH, PROTRUSIONS, OR GATE BURRS SHALL NOT EXCEED 0.006 INCHES PER SIDE.
- DIMENSIONS D AND E ARE DETERMINED AT THE OUTERMOST EXTREMES OF THE PLASTIC BODY.
- DATUMS A AND B ARE DETERMINED AT DATUM PLANE H.
- OPTIONAL MOLD FEATURE.

DIM	INCHES		MILLIMETERS	
	MIN	MAX	MIN	MAX
A	0.086	0.094	2.18	2.38
A1	0.000	0.005	0.00	0.13
b	0.025	0.035	0.63	0.89
b2	0.028	0.045	0.72	1.14
b3	0.180	0.215	4.57	5.46
c	0.018	0.024	0.46	0.61
c2	0.018	0.024	0.46	0.61
D	0.235	0.245	5.97	6.22
E	0.250	0.265	6.35	6.73
e	0.090 BSC		2.29 BSC	
H	0.370	0.410	9.40	10.41
L	0.055	0.070	1.40	1.78
L1	0.114 REF		2.90 REF	
L2	0.020 BSC		0.51 BSC	
L3	0.035	0.050	0.89	1.27
L4	---	0.040	---	1.01
Z	0.155	---	3.93	---

### GENERIC MARKING DIAGRAM\*

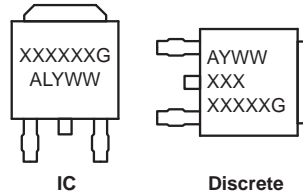

- XXXXXX = Device Code  
A = Assembly Location  
L = Wafer Lot  
Y = Year  
WW = Work Week  
G = Pb-Free Package

\*This information is generic. Please refer to device data sheet for actual part marking.

## ORDERING INFORMATION

Device	Package	Shipping	note
NGTB03N60R2DT4G	DPAK	2500 pcs. / reel	Pb-Free And Halogen Free

ON Semiconductor and the ON logo are registered trademarks of Semiconductor Components Industries, LLC (SCILLC) or its subsidiaries in the United States and/or other countries. SCILLC owns the rights to a number of patents, trademarks, copyrights, trade secrets, and other intellectual property. A listing of SCILLC's product/patent coverage may be accessed at [www.onsemi.com/site/pdf/Patent-Marking.pdf](http://www.onsemi.com/site/pdf/Patent-Marking.pdf). SCILLC reserves the right to make changes without further notice to any products herein. SCILLC makes no warranty, representation or guarantee regarding the suitability of its products for any particular purpose, nor does SCILLC assume any liability arising out of the application or use of any product or circuit, and specifically disclaims any and all liability, including without limitation special, consequential or incidental damages. "Typical" parameters which may be provided in SCILLC data sheets and/or specifications can and do vary in different applications and actual performance may vary over time. All operating parameters, including "Typicals" must be validated for each customer application by customer's technical experts. SCILLC does not convey any license under its patent rights nor the rights of others. SCILLC products are not designed, intended, or authorized for use as components in systems intended for surgical implant into the body, or other applications intended to support or sustain life, or for any other application in which the failure of the SCILLC product could create a situation where personal injury or death may occur. Should Buyer purchase or use SCILLC products for any such unintended or unauthorized application, Buyer shall indemnify and hold SCILLC and its officers, employees, subsidiaries, affiliates, and distributors harmless against all claims, costs, damages, and expenses, and reasonable attorney fees arising out of, directly or indirectly, any claim of personal injury or death associated with such unintended or unauthorized use, even if such claim alleges that SCILLC was negligent regarding the design or manufacture of the part. SCILLC is an Equal Opportunity/Affirmative Action Employer. This literature is subject to all applicable copyright laws and is not for resale in any manner.

Компания «Океан Электроники» предлагает заключение долгосрочных отношений при поставках импортных электронных компонентов на взаимовыгодных условиях!

Наши преимущества:

- Поставка оригинальных импортных электронных компонентов напрямую с производств Америки, Европы и Азии, а так же с крупнейших складов мира;
- Широкая линейка поставок активных и пассивных импортных электронных компонентов (более 30 млн. наименований);
- Поставка сложных, дефицитных, либо снятых с производства позиций;
- Оперативные сроки поставки под заказ (от 5 рабочих дней);
- Экспресс доставка в любую точку России;
- Помощь Конструкторского Отдела и консультации квалифицированных инженеров;
- Техническая поддержка проекта, помощь в подборе аналогов, поставка прототипов;
- Поставка электронных компонентов под контролем ВП;
- Система менеджмента качества сертифицирована по Международному стандарту ISO 9001;
- При необходимости вся продукция военного и аэрокосмического назначения проходит испытания и сертификацию в лаборатории (по согласованию с заказчиком);
- Поставка специализированных компонентов военного и аэрокосмического уровня качества (Xilinx, Altera, Analog Devices, Intersil, Interpoint, Microsemi, Actel, Aeroflex, Peregrine, VPT, Syfer, Eurofarad, Texas Instruments, MS Kennedy, Miteq, Cobham, E2V, MA-COM, Hittite, Mini-Circuits, General Dynamics и др.);

Компания «Океан Электроники» является официальным дистрибьютором и эксклюзивным представителем в России одного из крупнейших производителей разъемов военного и аэрокосмического назначения «JONHON», а так же официальным дистрибьютором и эксклюзивным представителем в России производителя высокотехнологичных и надежных решений для передачи СВЧ сигналов «FORSTAR».



## JONHON

«JONHON» (основан в 1970 г.)

Разъемы специального, военного и аэрокосмического назначения:

(Применяются в военной, авиационной, аэрокосмической, морской, железнодорожной, горно- и нефтедобывающей отраслях промышленности)

«FORSTAR» (основан в 1998 г.)

ВЧ соединители, коаксиальные кабели, кабельные сборки и микроволновые компоненты:

(Применяются в телекоммуникациях гражданского и специального назначения, в средствах связи, РЛС, а так же военной, авиационной и аэрокосмической отраслях промышленности).



Телефон: 8 (812) 309-75-97 (многоканальный)

Факс: 8 (812) 320-03-32

Электронная почта: [ocean@oceanchips.ru](mailto:ocean@oceanchips.ru)

Web: <http://oceanchips.ru/>

Адрес: 198099, г. Санкт-Петербург, ул. Калинина, д. 2, корп. 4, лит. А