

## **HSMx-A4xx-xxxxx**

### **SMT LED Surface-Mount LED Indicator**



## **Description**

The Broadcom<sup>®</sup> Power PLCC-4 is an extension of our PLCC2 SMT LEDs. The package can be driven at higher current due to its superior package design. The product is able to dissipate heat more efficiently compared to the conventional PLCC-2 SMT LEDs. In proportion to the increase in driving current, this family of LEDs is able to produce higher light output compared to the conventional PLCC-2 SMT LEDs.

These SMT LEDs have higher reliability and better performance and are designed to work under a wide range of environmental conditions. This higher reliability makes them suitable for use under harsh environment and conditions like automotive. In addition, they are also suitable to be used in electronic signs and signals.

To facilitate easy pick and place assembly, the LEDs are packed in EIA-compliant tape and reel. Every reel will be shipped in single intensity and color bin (except for red color), to provide close uniformity.

These LEDs are compatible with IR solder reflow process. Due to the high reliability feature of these products, they also can be mounted using through-the-wave soldering process.

There are a variety of colors and various viewing angles (30°, 60°, and 120°) available in these SMT LEDs. Ideally, the 30° parts are suitable for light piping where focused intensities are required. As for the 60° and 120°, they are most suitable for automotive interior and exterior lighting and electronic signs applications.

## **Features**

- Industry standard PLCC-4
- High reliability LED package
- High brightness using AlInGaP and InGaN dice technologies
- High optical efficiency
- Higher ambient temperature at the same current possible compared to PLCC-2
- Available in full selection of colors
- Super wide viewing angle at 120°
- Available in 8-mm carrier tape on 7-inch reel
- Compatible with both IR and TTW soldering process
- JEDEC MSL 2a
- High reliability LED package due to enhanced silicone resin material for InGaN family

## **Applications**

- Interior automotive
  - Instrument panel backlighting
  - Central console backlighting
  - Cabin backlighting
  - Navigation and audio system
  - Dome lighting
  - Push button backlighting
- Exterior automotive
  - Turn signals
  - CHMSL
  - Rear combination lamp
  - Puddle light
- Electronic signs and signals
  - Interior full color sign
  - Variable message sign

- Office automation, home appliances, industrial equipment
  - Front panel backlighting
  - Push button backlighting
  - Display backlighting

Figure 1: Package Dimensions

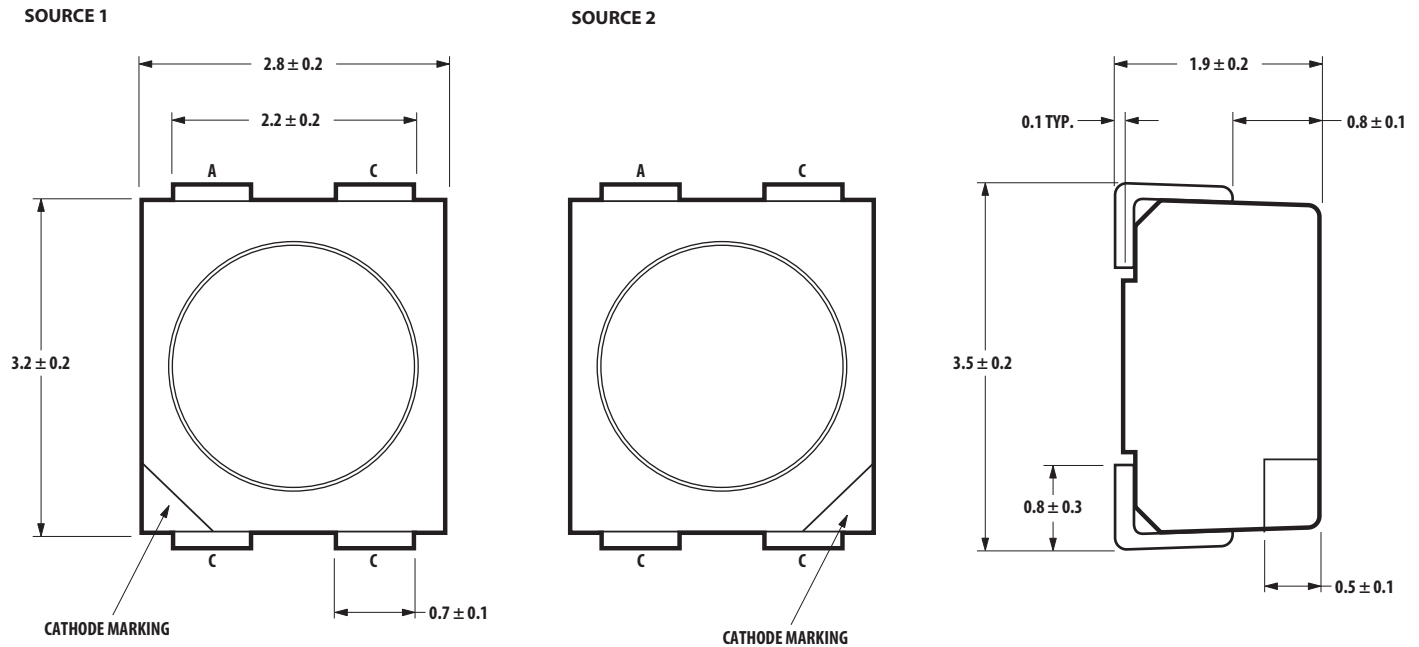

**NOTE:** All dimensions in millimeters. Electrical connection between all cathodes is recommended.

## Device Selection Guide

| Color         | Part Number     | Min. $I_V$ (mcd) <sup>a</sup> | Max. $I_V$ (mcd) | Test Current (mA) | Dice Technology |
|---------------|-----------------|-------------------------------|------------------|-------------------|-----------------|
| Red           | HSMC-A400-S30M1 | 180.00                        | 355.00           | 50                | AllnGaP         |
|               | HSMC-A401-U80M1 | 560.00                        | 1400.00          | 50                | AllnGaP         |
| Red Orange    | HSMJ-A401-T40M1 | 285.00                        | 715.00           | 50                | AllnGaP         |
|               | HSMJ-A401-U40M1 | 450.00                        | 1125.00          | 50                | AllnGaP         |
| Orange        | HSML-A401-U40M1 | 450.00                        | 1125.00          | 50                | AllnGaP         |
| Amber         | HSMA-A401-U45M1 | 450.00                        | 1125.00          | 50                | AllnGaP         |
| Emerald Green | HSME-A401-P4PM1 | 45.00                         | 112.50           | 50                | AllnGaP         |
| Blue          | HSMN-A400-S8QM2 | 224.00                        | 560.00           | 30                | InGaN           |
|               | HSMN-A400-S8PM2 | 224.00                        | 560.00           | 30                | InGaN           |
|               | HSMN-A400-S4QM2 | 180.00                        | 450.00           | 30                | InGaN           |
| Green         | HSMM-A400-W8QM2 | 1400.00                       | 3550.00          | 30                | InGaN           |
|               | HSMM-A400-W8YM2 | 1400.00                       | 3550.00          | 30                | InGaN           |

a. The luminous intensity  $I_V$  is measured at the mechanical axis of the lamp package. The actual peak of the spatial radiation pattern may not be aligned with this axis.  $I_V$  tolerance =  $\pm 12\%$ .

## Part Numbering System

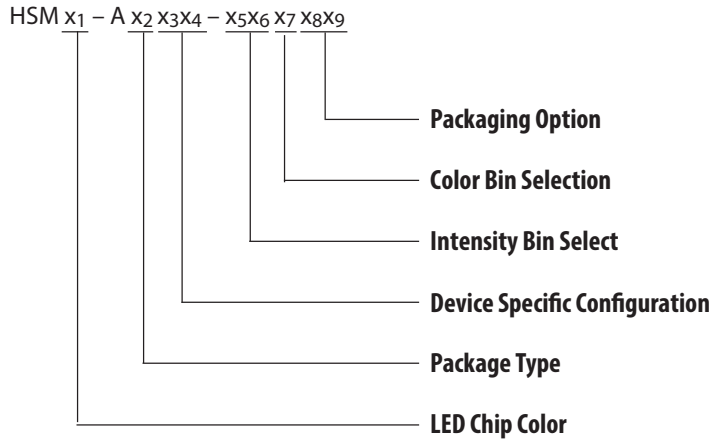

## Absolute Maximum Ratings (T<sub>A</sub> = 25°C)

| Parameters                        | HSMC/J/L/A/E          | HSMZ/V/U              | HSMM/N |
|-----------------------------------|-----------------------|-----------------------|--------|
| DC Forward Current <sup>a</sup>   | 70 mA <sup>b, c</sup> | 70 mA <sup>b, c</sup> | 30 mA  |
| Peak Forward Current <sup>d</sup> | 200 mA                | 200 mA                | 90 mA  |
| Power Dissipation                 | 180 mW                | 240 mW                | 114 mW |
| Reverse Voltage                   | 5V                    |                       |        |
| Junction Temperature              | 110°C                 |                       |        |
| Operating Temperature             | –40°C to +100°C       |                       |        |
| Storage Temperature               | –40°C to +100°C       |                       |        |

- Derate linearly as shown in [Figure 6](#).
- Drive current between 10 mA and 70 mA is recommended for best long-term performance.
- Operation at currents below 5 mA is not recommended.
- Duty factor = 10%, Frequency = 1 kHz.

## Optical Characteristics ( $T_A = 25^\circ\text{C}$ )

| Color         | Part Number | Peak Wavelength<br>$\lambda_{\text{PEAK}}$ (nm)<br>Typ. | Dominant Wavelength $\lambda_D^a$<br>(nm)<br>Typ. | Viewing Angle<br>$2\Theta_{1/2}^b$<br>(Degrees)<br>Typ. | Luminous Efficacy $\eta_V^c$ (lm/W)<br>Typ. | Luminous Intensity/Total Flux $I_V$ (mcd)/ $\Phi_V$ (mIm)<br>Typ. |
|---------------|-------------|---|---|---|---|---|
| Red           | HSMC        | 635   | 626   | 120   | 150   | 0.45  |
|               | HSMZ        | 639   | 630   | 120   | 155   | 0.45  |
| Red Orange    | HSMJ        | 621   | 615   | 120   | 240   | 0.45  |
|               | HSMV        | 623   | 617   | 120   | 263   | 0.45  |
| Orange        | HSML        | 609   | 605   | 120   | 320   | 0.45  |
| Amber         | HSMA        | 592   | 590   | 120   | 480   | 0.45  |
|               | HSMU        | 594   | 592   | 120   | 500   | 0.45  |
| Yellow Green  | HSME        | 576   | 575   | 120   | 560   | 0.45  |
| Emerald Green | HSME        | 568   | 567   | 120   | 610   | 0.45  |
| Green         | HSMM        | 518   | 525   | 120   | 500   | 0.45  |
| Blue          | HSMN        | 468   | 470   | 120   | 75  | 0.45  |

a. The dominant wavelength,  $\lambda_D$ , is derived from the CIE Chromaticity Diagram and represents the color of the device.

b.  $\Theta_{1/2}$  is the off-axis angle where the luminous intensity is 1/2 the peak intensity.

c. Radiant intensity,  $I_e$  in watts/steradian, may be calculated from the equation  $I_e = I_V/\eta_V$ , where  $I_V$  is the luminous intensity in candelas and  $\eta_V$  is the luminous efficacy in lumens/watt.

## Electrical Characteristics ( $T_A = 25^\circ\text{C}$ )

| Part Number  | Forward Voltage<br>$V_F$ (Volts) at $I_F = 50$ mA |      | Reverse Voltage<br>$V_R$ at 100 $\mu\text{A}$ |
|--------------|---|------|---|
|              | Typ.  | Max. | Min.  |
| HSMC/J/L/A/E | 2.2   | 2.5  | 5   |
| HSMZ/V/U     | 2.8   | 3.4  | 5   |
| Part Number  | Forward Voltage<br>$V_F$ (Volts) at $I_F = 30$ mA |      | Reverse Voltage<br>$V_R$ at 10 $\mu\text{A}$  |
|              | Typ.  | Max. | Min.  |
| HSMN/N       | 3.8   | 4.6  | 5   |

Figure 2: Relative Intensity vs. Wavelength

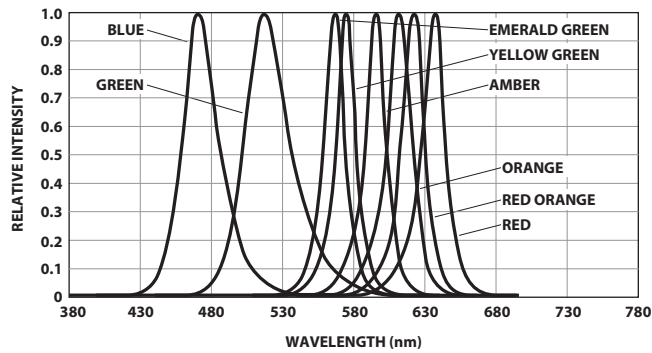

Figure 3: Forward Current vs. Forward Voltage

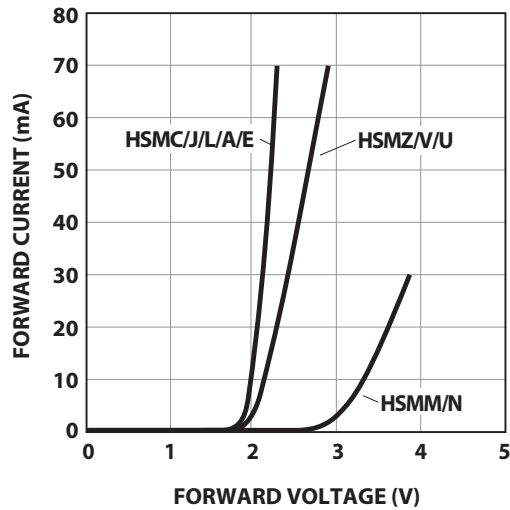

Figure 4: Relative Intensity vs. Forward Current (AlInGaP)

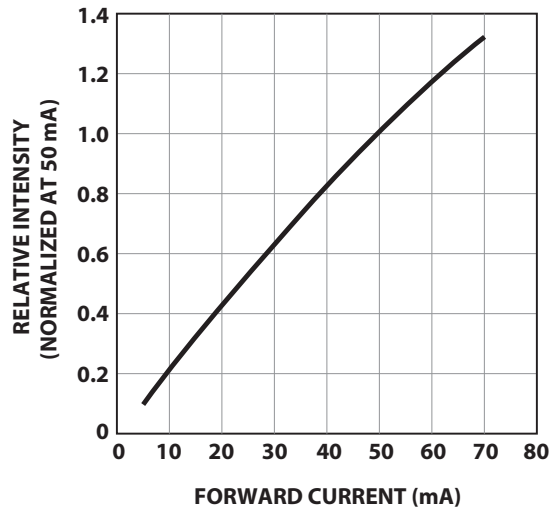

Figure 5: Relative Intensity vs. Forward Current (InGaN)

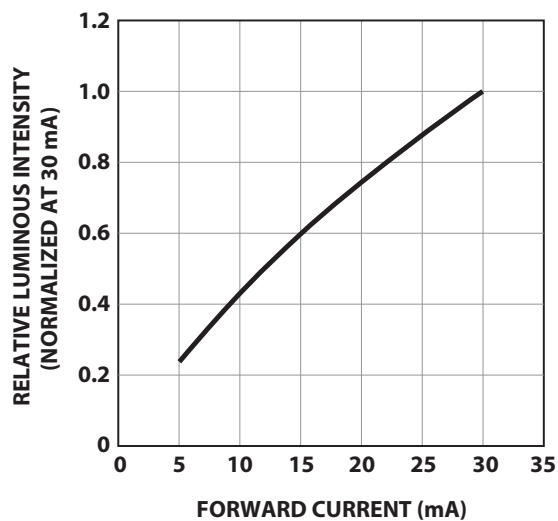
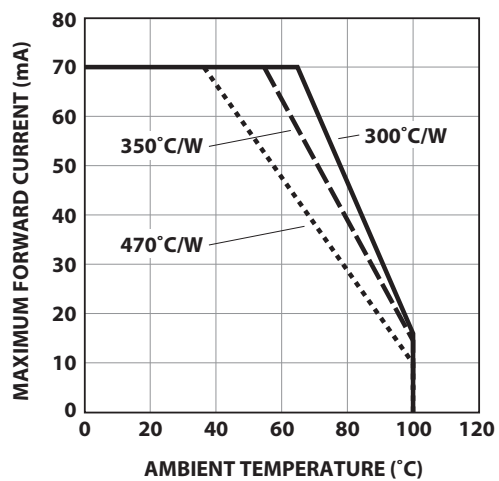
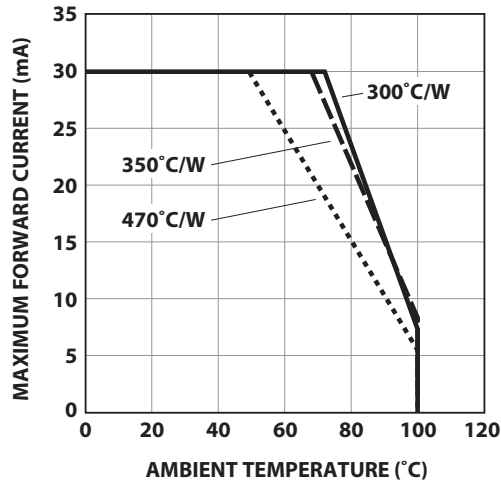

Figure 6: Maximum Forward Current vs. Ambient Temperature, Derated Based on T<sub>j</sub>max = 110°C (AlInGaP)



**Figure 7: Maximum Forward Current vs. Ambient Temperature, Derated Based on  $T_{jmax} = 110^{\circ}C$  (InGaN)**



**Figure 8: Dominant Wavelength vs. Forward Current – InGaN Devices**

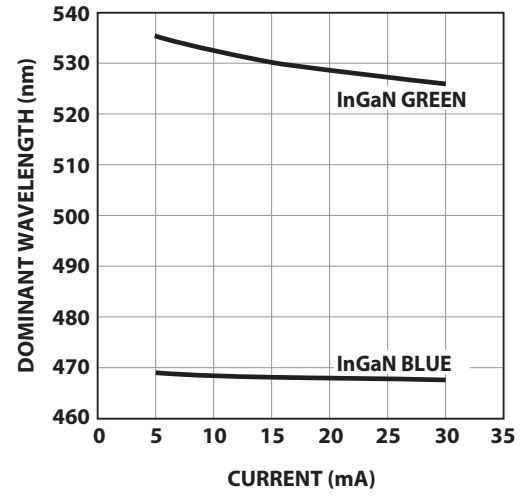

**Figure 9: Radiation Pattern**

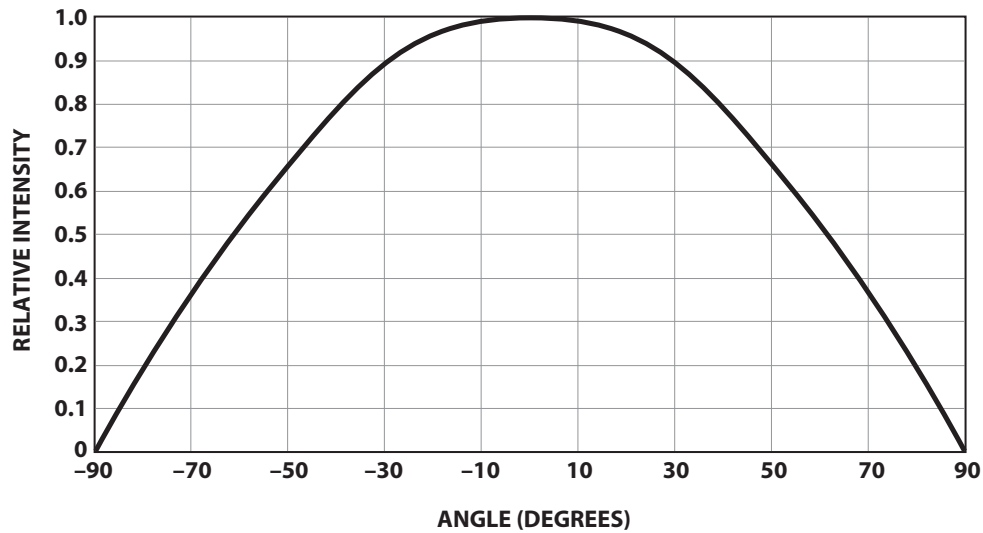

Figure 10: Recommended Soldering Pad Pattern

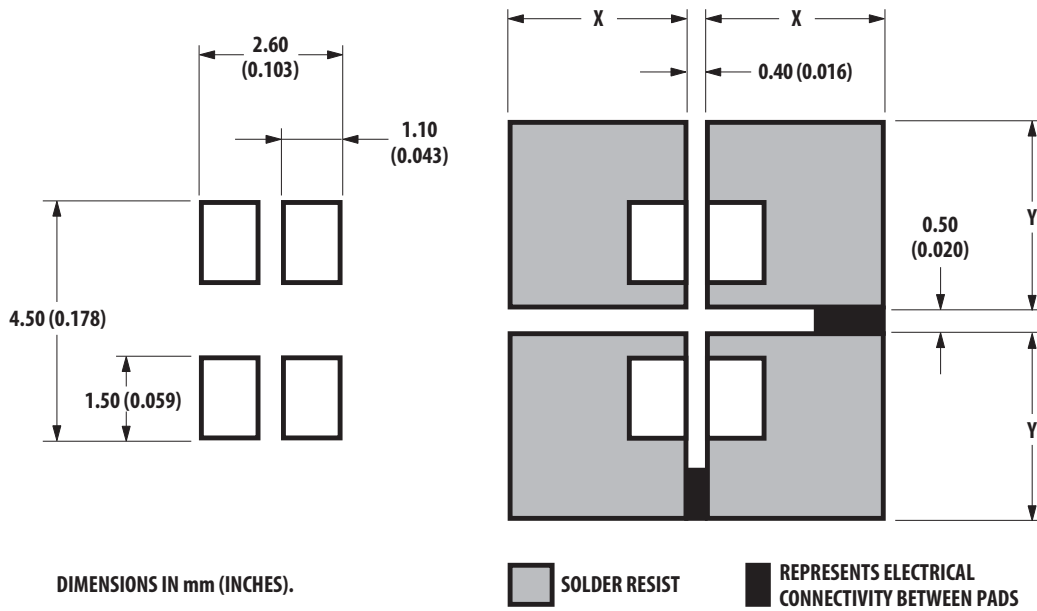

Figure 11: Recommended Soldering Pad Pattern (TTW)

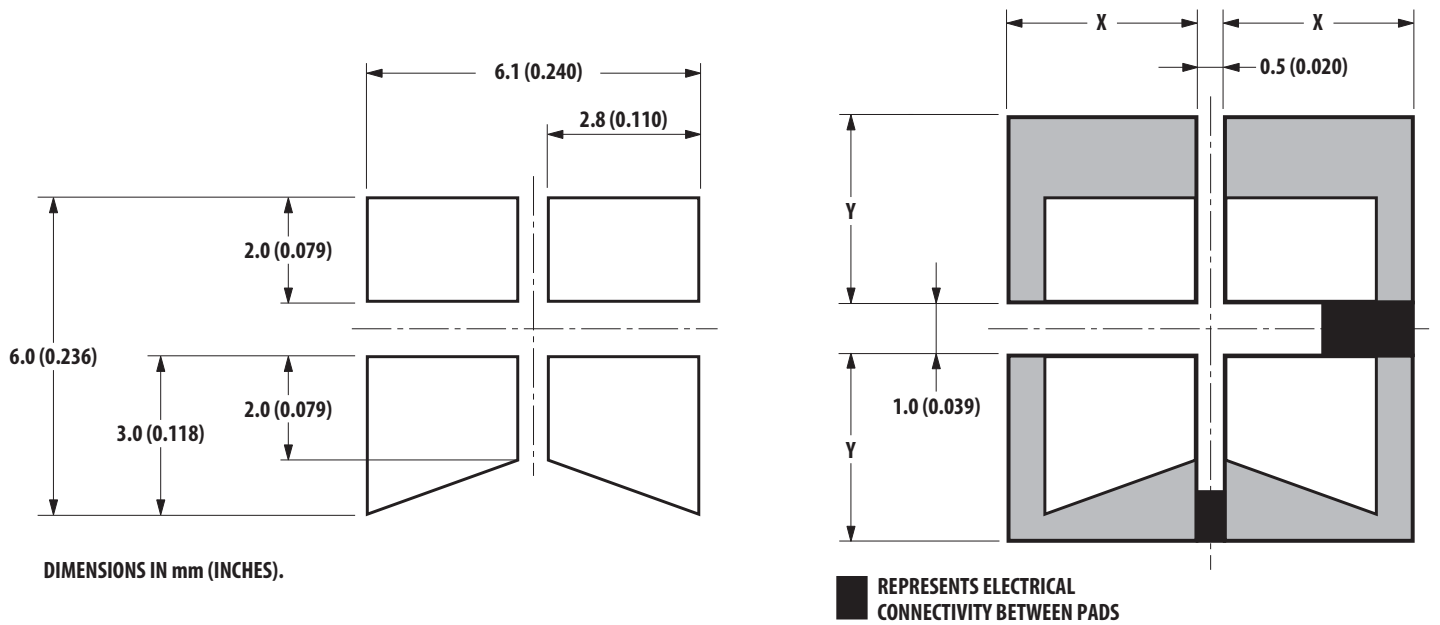
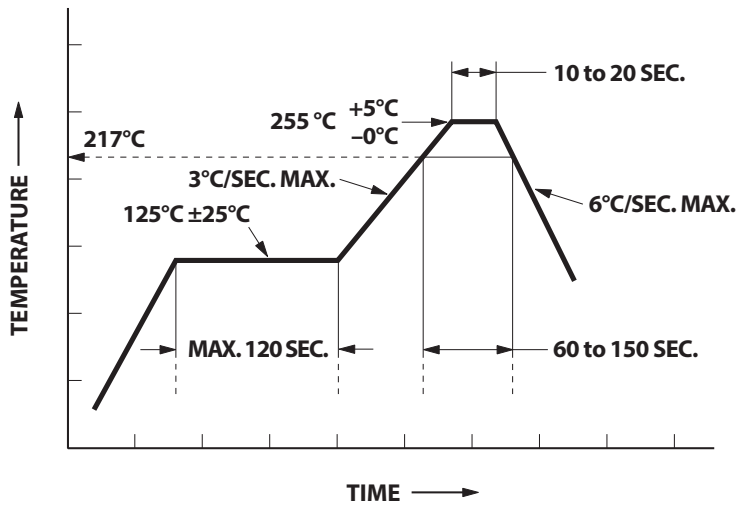

Figure 12: Recommended Pb-Free Reflow Soldering Profile



\* THE TIME FROM 25°C TO PEAK TEMPERATURE = 6 MINUTES MAX.

**NOTE:** For detailed information on reflow soldering of Broadcom surface-mount LEDs, refer to Application Note AN 1060, *Surface Mounting SMT LED Indicator Components*.

Figure 13: Tape Leader and Trailer Dimensions

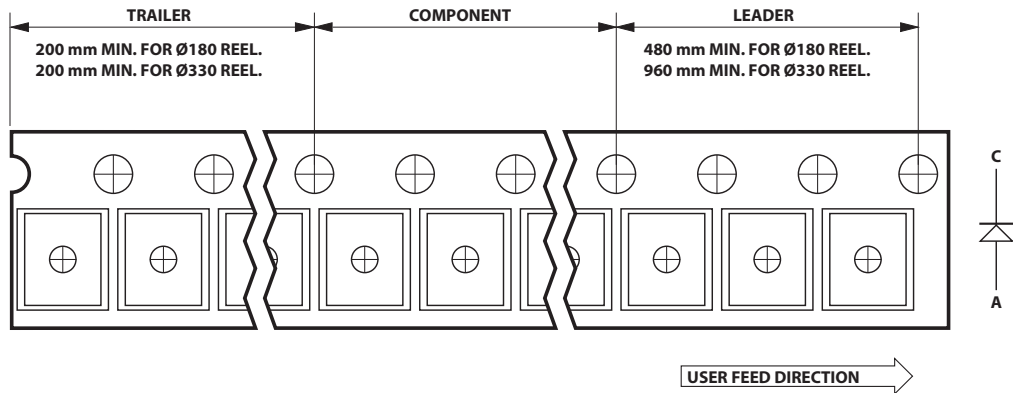





## Bin Information

### Intensity Bin Select ( $X_5X_6$ )

Individual reel will contain parts from one half bin only.

| $X_5$ | Min. $I_V$ Bin                   |
|-------|----------------------------------|
| $X_6$ |                                  |
| 0     | Full Distribution                |
| 2     | 2 half bins starting from $X_51$ |
| 3     | 3 half bins starting from $X_51$ |
| 4     | 4 half bins starting from $X_51$ |
| 5     | 5 half bins starting from $X_51$ |
| 6     | 2 half bins starting from $X_52$ |
| 7     | 3 half bins starting from $X_52$ |
| 8     | 4 half bins starting from $X_52$ |
| 9     | 5 half bins starting from $X_52$ |

## Intensity Bin Limits

| Bin ID | Min. (mcd) | Max. (mcd) |
|--------|------------|------------|
| N1     | 28.50      | 35.50      |
| N2     | 35.50      | 45.00      |
| P1     | 45.00      | 56.00      |
| P2     | 56.00      | 71.50      |
| Q1     | 71.50      | 90.00      |
| Q2     | 90.00      | 112.50     |
| R1     | 112.50     | 140.00     |
| R2     | 140.00     | 180.00     |
| S1     | 180.00     | 224.00     |
| S2     | 224.00     | 285.00     |
| T1     | 285.00     | 355.00     |
| T2     | 355.00     | 450.00     |
| U1     | 450.00     | 560.00     |
| U2     | 560.00     | 715.00     |
| V1     | 715.00     | 900.00     |
| V2     | 900.00     | 1125.00    |
| W1     | 1125.00    | 1400.00    |
| W2     | 1400.00    | 1800.00    |
| X1     | 1800.00    | 2240.00    |
| X2     | 2240.00    | 2850.00    |
| Y1     | 2850.00    | 3550.00    |
| Y2     | 3550.00    | 4500.00    |
| Z1     | 4500.00    | 5600.00    |
| Z2     | 5600.00    | 7150.00    |
| 11     | 7150.00    | 9000.00    |
| 12     | 9000.00    | 11250.00   |

## Color Bin Select (X<sub>7</sub>)

Individual reel will contain parts from one half bin only.

| X <sub>7</sub> |                        |
|----------------|------------------------|
| 0              | Full Distribution      |
| Z              | A and B only           |
| Y              | B and C only           |
| W              | C and D only           |
| V              | D and E only           |
| U              | E and F only           |
| T              | F and G only           |
| S              | G and H only           |
| Q              | A, B, and C only       |
| P              | B, C, and D only       |
| N              | C, D, and E only       |
| M              | D, E, and F only       |
| L              | E, F, and G only       |
| K              | F, G, and H, only      |
| 1              | A, B, C, and D only    |
| 2              | E, F, G, and H only    |
| 3              | B, C, D, and E only    |
| 4              | C, D, E, and F only    |
| 5              | A, B, C, D, and E only |
| 6              | B, C, D, E, and F only |

## Color Bin Limits

| Blue | Min. (nm) | Max. (nm) |
|------|-----------|-----------|
| A    | 460.0     | 465.0     |
| B    | 465.0     | 470.0     |
| C    | 470.0     | 475.0     |
| D    | 475.0     | 480.0     |

| Green | Min. (nm) | Max. (nm) |
|-------|-----------|-----------|
| A     | 515.0     | 520.0     |
| B     | 520.0     | 525.0     |
| C     | 525.0     | 530.0     |
| D     | 530.0     | 535.0     |

| Emerald Green | Min. (nm) | Max. (nm) |
|---------------|-----------|-----------|
| A             | 552.5     | 555.5     |

| Emerald Green (Continued) | Min. (nm) | Max. (nm) |
|---------------------------|-----------|-----------|
| B                         | 555.5     | 558.5     |
| C                         | 558.5     | 561.5     |
| D                         | 561.5     | 564.5     |

| Yellow Green | Min. (nm) | Max. (nm) |
|--------------|-----------|-----------|
| A            | 564.5     | 567.5     |
| B            | 567.5     | 570.5     |
| C            | 570.5     | 573.5     |
| D            | 573.5     | 576.5     |

| Amber/Yellow | Min. (nm) | Max. (nm) |
|--------------|-----------|-----------|
| A            | 582.0     | 584.5     |
| B            | 584.5     | 587.0     |
| C            | 587.0     | 589.5     |
| D            | 589.5     | 592.0     |
| E            | 592.0     | 594.5     |
| F            | 594.5     | 597.0     |

| Orange | Min. (nm) | Max. (nm) |
|--------|-----------|-----------|
| A      | 597.0     | 600.0     |
| B      | 600.0     | 603.0     |
| C      | 603.0     | 606.0     |
| D      | 606.0     | 609.0     |
| E      | 609.0     | 612.0     |

| Red Orange | Min. (nm) | Max. (nm) |
|------------|-----------|-----------|
| A          | 611.0     | 616.0     |
| B          | 616.0     | 620.0     |

| Red               | Min. (nm) | Max. (nm) |
|-------------------|-----------|-----------|
| Full Distribution |           |           |

**NOTE:** Tolerance of each bin limit = ±1 nm.

## Forward Voltage Bin Table

For HSMZ/V/U – A4xx-xxxxx only.

| Bin | Min. | Max. |
|-----|------|------|
| VA  | 1.9  | 2.2  |
| VB  | 2.2  | 2.5  |
| VC  | 2.5  | 2.8  |
| VD  | 2.8  | 3.1  |
| VE  | 3.1  | 3.4  |

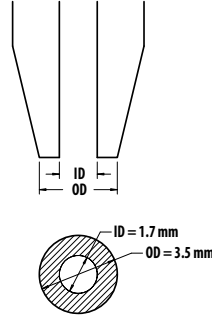

## Precautionary Notes

### Handling Precautions

The encapsulation material of the LED is made of silicone for better product reliability. Compared to epoxy encapsulant that is hard and brittle, silicone is softer and flexible. Special handling precautions need to be observed during assembly of silicone encapsulated LED products. Failure to comply might lead to damage and premature failure of the LED. Refer to Application Note AN5288, *Silicone Encapsulation for LED: Advantages and Handling Precautions* for additional information.

- Do not poke sharp objects into the silicone encapsulant. Sharp objects, such as tweezers or syringes, might apply excessive force or even pierce through the silicone and induce failures to the LED die or wire bond.
- Do not touch the silicone encapsulant. Uncontrolled force acting on the silicone encapsulant might result in excessive stress on the wire bond. Hold the LED only by the body.
- Do not stack assembled PCBs together. Use an appropriate rack to hold the PCBs.
- The surface of the silicone material attracts dust and dirt easier than epoxy due to its surface tackiness. To remove foreign particles on the surface of silicone, use a cotton bud with isopropyl alcohol (IPA). During cleaning, rub the surface gently without putting much pressure on the silicone. Ultrasonic cleaning is not recommended.
- For automated pick and place, Broadcom has tested the following nozzle size to work well with this LED. However, due to the possibility of variations in other parameters, such as pick and place machine maker/model and other settings of the machine, verify that the nozzle selected will not cause damage to the LED.

## Handling of Moisture-Sensitive Devices

This product has a Moisture Sensitive Level 2 rating per JEDEC J-STD-020. Refer to Application Note AN5305, *Handling of Moisture Sensitive Surface Mount Devices*, for additional details and a review of proper handling procedures.

### ■ Before use:

- An unopened moisture barrier bag (MBB) can be stored at < 40°C/90% RH for 12 months. If the actual shelf life has exceeded 12 months and the humidity indicator card (HIC) indicates that baking is not required, it is safe to reflow the LEDs per the original MSL rating.
- Do not open the MBB prior to assembly (IQC for example).

### ■ Control after opening the MBB:

- Read the HIC immediately upon opening the MBB.
- Keep the LEDs at <30°C/60% RH at all times and all high temperature-related processes, including soldering, curing, or rework, must be completed within 672 hours.

### ■ Control for unfinished reel:

Store unused LEDs in a sealed MBB with desiccant or desiccator at <5% RH.

### ■ Control of assembled boards:

If the PCB soldered with the LEDs is to be subjected to other high-temperature processes, store the PCB in a sealed MBB with desiccant or desiccator at <5% RH to ensure that all LEDs have not exceeded their floor life of 672 hours.

### ■ Baking is required if the following conditions exist:

- The HIC indicator is not BROWN at 10% and is AZURE at 5%.
- The LEDs are exposed to conditions of > 30°C/60% RH at any time.
- The LED floor life exceeded 168 hours.

The recommended baking condition is: 60°C ± 5°C for 20 hours.

Baking should only be done once.

■ **Storage:**

The soldering terminals of these Broadcom LEDs are silver plated. If the LEDs are being exposed in an ambient environment for too long, the silver plating might be oxidized, thus affecting its solderability performance. As such, keep unused LEDs in a sealed MBB with desiccant or in desiccator at <5% RH.

**Application Precautions**

- The drive current of the LED must not exceed the maximum allowable limit across temperature as stated in the data sheet. Constant current driving is recommended to ensure consistent performance.
- LEDs exhibit slightly different characteristics at different drive currents, which might result in larger variation their performance (meaning intensity, wavelength, and forward voltage). Set the application current as close as possible to the test current to minimize these variations.
- The LED is not intended for reverse bias. Use other appropriate components for such purposes. When driving the LED in matrix form, ensure that the reverse bias voltage does not exceed the allowable limit of the LED.
- Do not use the LED in the vicinity of material with sulfur content, in environments of high gaseous sulfur compounds and corrosive elements. Examples of material that may contain sulfur are rubber gaskets, RTV (room temperature vulcanizing) silicone rubber, rubber gloves, and so on. Prolonged exposure to such environments may affect the optical characteristics and product life.
- Avoid rapid change in ambient temperatures, especially in high-humidity environments, because this will cause condensation on the LED.
- Although the LED is rated as IPx6 according to IEC60529: Degree of protection provided by enclosure, the test condition may not represent actual exposure during application. If the LED is intended to be used in outdoor or harsh environments, the LED must be protected against damages caused by rain water, dust, oil, corrosive gases, external mechanical stress, and so on.

**Thermal Management**

Optical, electrical and reliability characteristics of LED are affected by temperature. The junction temperature ( $T_J$ ) of the LED must be kept below allowable limit at all times.  $T_J$  can be calculated as below:

$$T_J = T_A + R_{\theta J-A} \times I_F \times V_{Fmax}$$

where;

$T_A$  = Ambient temperature (°C)

$R_{\theta J-A}$  = Thermal resistance from LED junction to ambient (°C/W)

$I_F$  = Forward current (A)

$V_{Fmax}$  = Maximum forward voltage (V)

The complication of using this formula lies in  $T_A$  and  $R_{\theta J-A}$ . Actual  $T_A$  is sometimes subjective and hard to determine.  $R_{\theta J-A}$  varies from system to system depending on design and is usually not known.

Another way of calculating  $T_J$  is by using solder point temperature  $T_S$  as follows:

$$T_J = T_S + R_{\theta J-S} \times I_F \times V_{Fmax}$$

where;

$T_S$  = LED solder point temperature as shown in the following figure (°C)

$R_{\theta J-S}$  = Thermal resistance from junction to solder point (°C/W)

Source 1

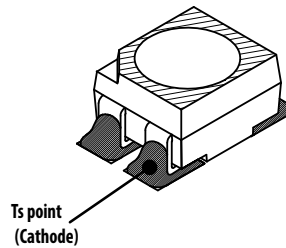

Source 2

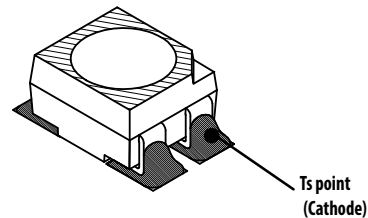

$T_S$  can be measured easily by mounting a thermocouple on the soldering joint as shown in the preceding figure, while  $R_{\theta J-S}$  is provided in the data sheet. User is advised to verify the TS of the LED in the final product to ensure that the LEDs are operated within all maximum ratings stated in the data sheet.

## Eye Safety Precautions

LEDs may pose optical hazards when in operation. Do not look directly at operating LEDs because it may be harmful to the eyes. For safety reasons, use appropriate shielding or personal protective equipment.

## Disclaimer

Broadcom's products and software are not specifically designed, manufactured, or authorized for sale as parts, components, or assemblies for the planning, construction, maintenance, or direct operation of a nuclear facility or for use in medical devices or applications. The customer is solely responsible, and waives all rights to make claims against Broadcom or its suppliers, for all loss, damage, expense, or liability in connection with such use.

Broadcom, the pulse logo, Connecting everything, Avago Technologies, Avago, and the A logo are among the trademarks of Broadcom and/or its affiliates in the United States, certain other countries, and/or the EU.

Copyright © 2013–2018 Broadcom. All Rights Reserved.

The term “Broadcom” refers to Broadcom Inc. and/or its subsidiaries. For more information, please visit [www.broadcom.com](http://www.broadcom.com).

Broadcom reserves the right to make changes without further notice to any products or data herein to improve reliability, function, or design. Information furnished by Broadcom is believed to be accurate and reliable. However, Broadcom does not assume any liability arising out of the application or use of this information, nor the application or use of any product or circuit described herein, neither does it convey any license under its patent rights nor the rights of others.



Компания «Океан Электроники» предлагает заключение долгосрочных отношений при поставках импортных электронных компонентов на взаимовыгодных условиях!

Наши преимущества:

- Поставка оригинальных импортных электронных компонентов напрямую с производств Америки, Европы и Азии, а так же с крупнейших складов мира;
- Широкая линейка поставок активных и пассивных импортных электронных компонентов (более 30 млн. наименований);
- Поставка сложных, дефицитных, либо снятых с производства позиций;
- Оперативные сроки поставки под заказ (от 5 рабочих дней);
- Экспресс доставка в любую точку России;
- Помощь Конструкторского Отдела и консультации квалифицированных инженеров;
- Техническая поддержка проекта, помощь в подборе аналогов, поставка прототипов;
- Поставка электронных компонентов под контролем ВП;
- Система менеджмента качества сертифицирована по Международному стандарту ISO 9001;
- При необходимости вся продукция военного и аэрокосмического назначения проходит испытания и сертификацию в лаборатории (по согласованию с заказчиком);
- Поставка специализированных компонентов военного и аэрокосмического уровня качества (Xilinx, Altera, Analog Devices, Intersil, Interpoint, Microsemi, Actel, Aeroflex, Peregrine, VPT, Syfer, Eurofarad, Texas Instruments, MS Kennedy, Miteq, Cobham, E2V, MA-COM, Hittite, Mini-Circuits, General Dynamics и др.);

Компания «Океан Электроники» является официальным дистрибьютором и эксклюзивным представителем в России одного из крупнейших производителей разъемов военного и аэрокосмического назначения «JONHON», а так же официальным дистрибьютором и эксклюзивным представителем в России производителя высокотехнологичных и надежных решений для передачи СВЧ сигналов «FORSTAR».



## JONHON

«JONHON» (основан в 1970 г.)

Разъемы специального, военного и аэрокосмического назначения:

(Применяются в военной, авиационной, аэрокосмической, морской, железнодорожной, горно- и нефтедобывающей отраслях промышленности)

«FORSTAR» (основан в 1998 г.)

ВЧ соединители, коаксиальные кабели,  
кабельные сборки и микроволновые компоненты:

(Применяются в телекоммуникациях гражданского и специального назначения, в средствах связи, РЛС, а так же военной, авиационной и аэрокосмической отраслях промышленности).



Телефон: 8 (812) 309-75-97 (многоканальный)

Факс: 8 (812) 320-03-32

Электронная почта: [ocean@oceanchips.ru](mailto:ocean@oceanchips.ru)

Web: <http://oceanchips.ru/>

Адрес: 198099, г. Санкт-Петербург, ул. Калинина, д. 2, корп. 4, лит. А