

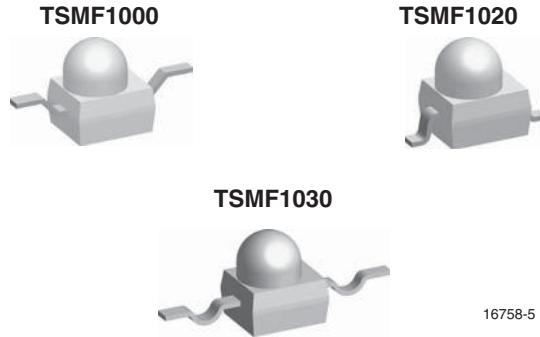

High Speed Infrared Emitting Diode, RoHS Compliant, 890 nm, GaAlAs Double Hetero



FEATURES

- Package type: surface mount
- Package form: GW, RGW, yoke, axial
- Dimensions (L x W x H in mm): 2.5 x 2 x 2.7
- Peak wavelength: $\lambda_p = 890 \text{ nm}$
- High radiant power
- Angle of half intensity: $\phi = \pm 17^\circ$
- Low forward voltage
- Suitable for high pulse current operation
- Versatile terminal configurations
- Package matches with detector TEMD1000
- Floor life: 168 h, MSL 3, acc. J-STD-020
- Compliant to RoHS Directive 2002/95/EC and in accordance with WEEE 2002/96/EC



RoHS COMPLIANT

DESCRIPTION

TSMF1000 series are infrared, 890 nm emitting diodes in GaAlAs double hetero (DH) technology with high radiant power and high speed, molded in clear, untinted plastic packages (with lens) for surface mounting (SMD).

APPLICATIONS

- IrDA compatible data transmission
- Miniature light barrier
- Photointerrupters
- Optical switch
- Control and drive circuits
- Shaft encoders

PRODUCT SUMMARY				
COMPONENT	I_e (mW/sr)	ϕ (deg)	λ_p (nm)	t_r (ns)
TSMF1000	5	± 17	890	30
TSMF1020	5	± 17	890	30
TSMF1030	5	± 17	890	30

Note

- Test conditions see table "Basic Characteristics"

ORDERING INFORMATION			
ORDERING CODE	PACKAGING	REMARKS	PACKAGE FORM
TSMF1000	Tape and reel	MOQ: 1000 pcs, 1000 pcs/reel	Reverse gullwing
TSMF1020	Tape and reel	MOQ: 1000 pcs, 1000 pcs/reel	Gullwing
TSMF1030	Tape and reel	MOQ: 1000 pcs, 1000 pcs/reel	Yoke

Note

- MOQ: minimum order quantity



ABSOLUTE MAXIMUM RATINGS (T _{amb} = 25 °C, unless otherwise specified)				
PARAMETER	TEST CONDITION	SYMBOL	VALUE	UNIT
Reverse voltage		V _R	5	V
Forward current		I _F	100	mA
Peak forward current	t _p /T = 0.5, t _p = 100 μs	I _{FM}	200	mA
Surge forward current	t _p = 100 μs	I _{FSM}	0.8	A
Power dissipation		P _V	180	mW
Junction temperature		T _j	100	°C
Operating temperature range		T _{amb}	- 40 to + 85	°C
Storage temperature range		T _{stg}	- 40 to + 100	°C
Soldering temperature	t ≤ 5 s	T _{sd}	260	°C
Thermal resistance junction/ambient	Soldered on PCB, pad dimensions: 4 mm x 4 mm	R _{thJA}	400	K/W

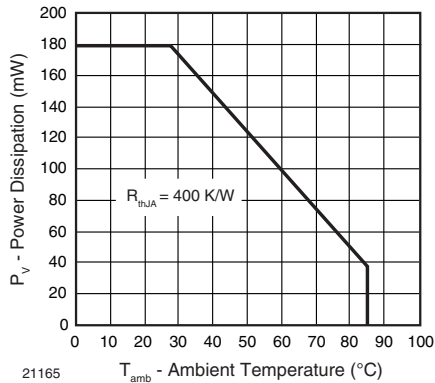

Fig. 1 - Power Dissipation Limit vs. Ambient Temperature

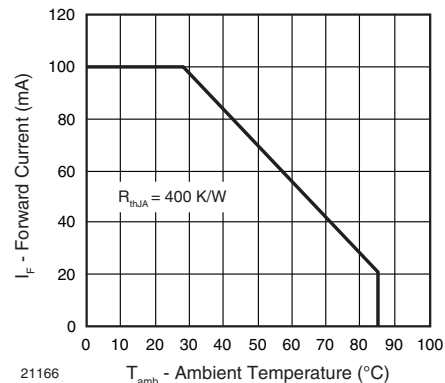

Fig. 2 - Forward Current Limit vs. Ambient Temperature

BASIC CHARACTERISTICS (T _{amb} = 25 °C, unless otherwise specified)						
PARAMETER	TEST CONDITION	SYMBOL	MIN.	TYP.	MAX.	UNIT
Forward voltage	I _F = 20 mA	V _F		1.3	1.5	V
	I _F = 1 A, t _p = 100 μs	V _F		2.4		V
Temperature coefficient of V _F	I _F = 1 mA	TK _{V_F}		- 1.8		mV/K
Reverse current	V _R = 5 V	I _R			10	μA
Junction capacitance	V _R = 0 V, f = 1 MHz, E = 0	C _j		160		pF
Radiant intensity	I _F = 20 mA	I _e	2.5	5	13	mW/sr
	I _F = 100 mA, t _p = 100 μs	I _e		25		mW/sr
Radiant power	I _F = 100 mA, t _p = 20 ms	φ _e		35		mW
Temperature coefficient of φ _e	I _F = 20 mA	TKφ _e		- 0.6		%/K
Angle of half intensity		φ		± 17		deg
Peak wavelength	I _F = 20 mA	λ _p		890		nm
Spectral bandwidth	I _F = 20 mA	Δλ		40		nm
Temperature coefficient of λ _p	I _F = 20 mA	TKλ _p		0.2		nm/K
Rise time	I _F = 20 mA	t _r		30		ns
Fall time	I _F = 20 mA	t _f		30		ns
Cut-off frequency	I _{DC} = 70 mA, I _{AC} = 30 mA pp	f _c		12		MHz
Virtual source diameter		d		1.2		mm

BASIC CHARACTERISTICS ($T_{amb} = 25\text{ }^{\circ}\text{C}$, unless otherwise specified)

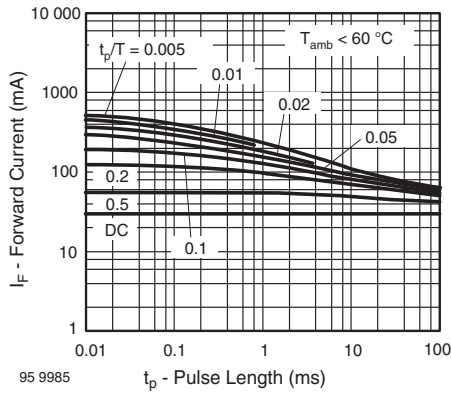

Fig. 3 - Pulse Forward Current vs. Pulse Duration

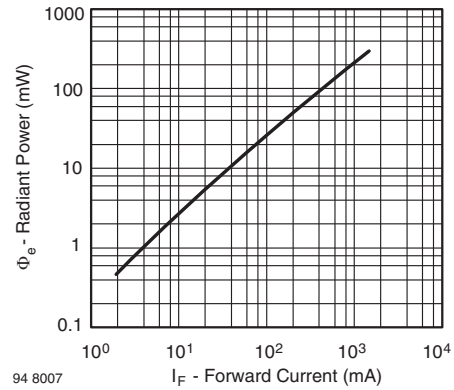

Fig. 6 - Radiant Power vs. Forward Current

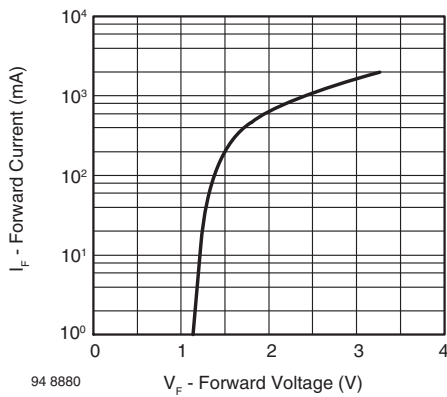

Fig. 4 - Forward Current vs. Forward Voltage

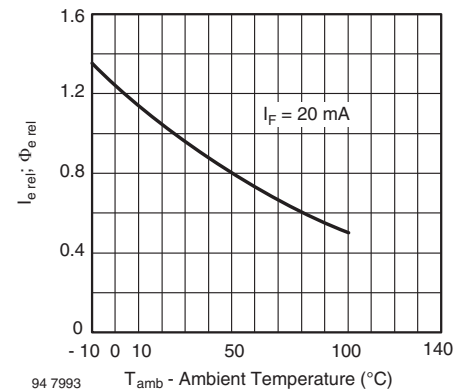

Fig. 7 - Rel. Radiant Intensity/Power vs. Ambient Temperature

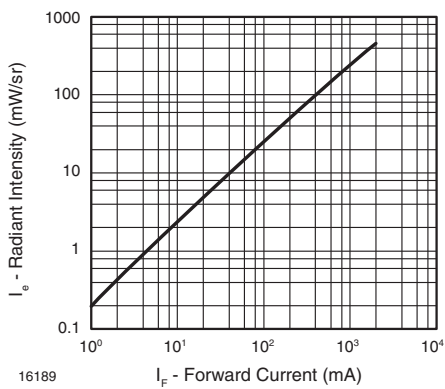

Fig. 5 - Radiant Intensity vs. Forward Current

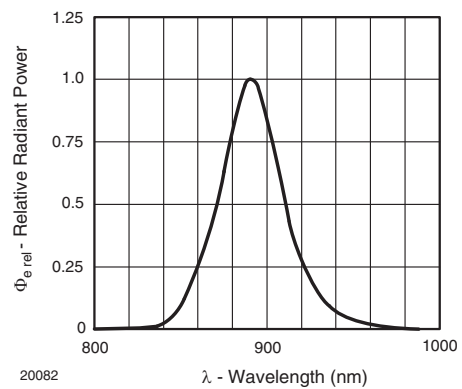

Fig. 8 - Relative Radiant Power vs. Wavelength

REFLOW SOLDER PROFILE

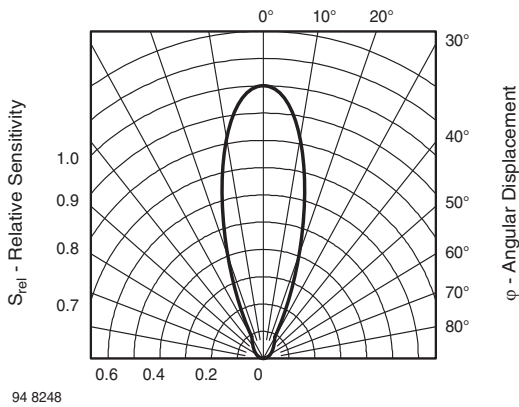

Fig. 9 - Relative Radiant Intensity vs. Angular Displacement

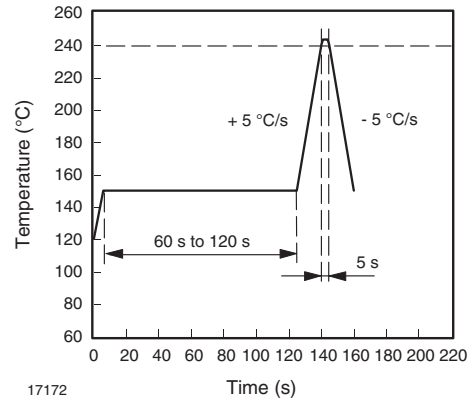

Fig. 10 - Lead Tin (SnPb) Reflow Solder Profile

PRECAUTIONS FOR USE

1. Over-current-proof

Customer must apply resistors for protection, otherwise slight voltage shift will cause big current change (burn out will happen).

2. Storage

- Storage temperature and rel. humidity conditions are: 5 °C to 35 °C, R.H. 60 %.
- Floor life must not exceed 168 h, acc. to JEDEC level 3, J-STD-020.
Once the package is opened, the products should be used within a week. Otherwise, they should be kept in a damp proof box with desiccant. Considering tape life, we suggest to use products within one year from production date.
- If opened more than one week in an atmosphere 5 °C to 35 °C, R.H. 60 %, devices should be treated at 60 °C ± 5 °C for 15 h.
- If humidity indicator in the package shows pink color (normal blue), then devices should be treated with the same conditions as 2.3.

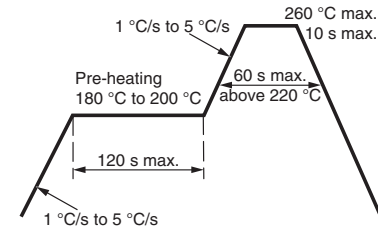

22566

Fig. 11 - Lead (Pb)-Free Reflow Solder Profile acc. J-STD-020



PACKAGE DIMENSIONS in millimeters: TSMF1000

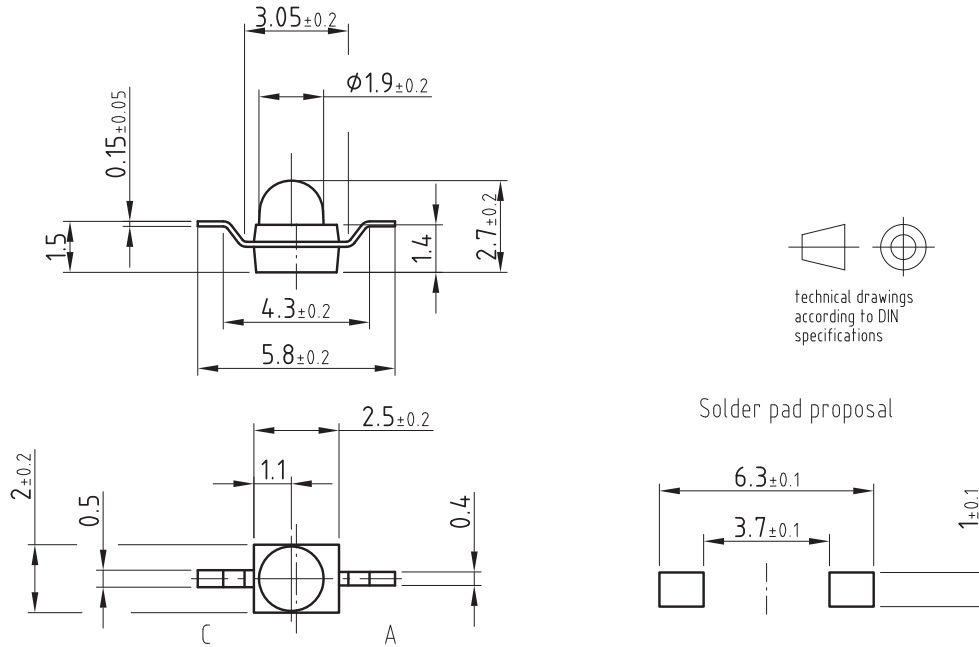

Drawing-No.: 6.544-5326.02-4

Issue: 3; 02.04.03

16159

PACKAGE DIMENSIONS in millimeters: TSMF1020

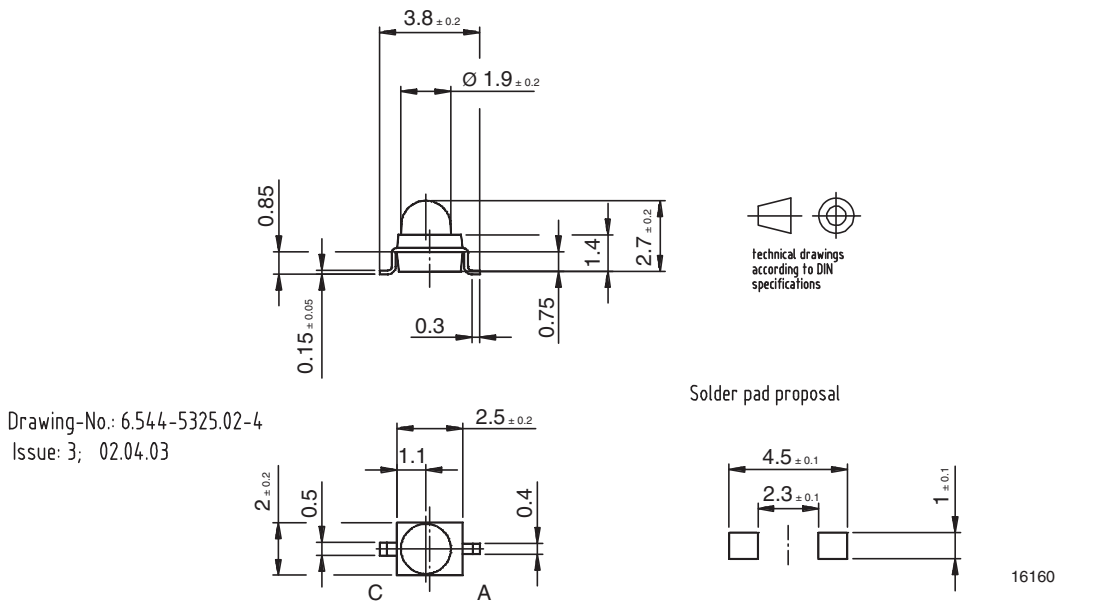

Drawing-No.: 6.544-5325.02-4

Issue: 3; 02.04.03

16160



PACKAGE DIMENSIONS in millimeters: TSMF1030

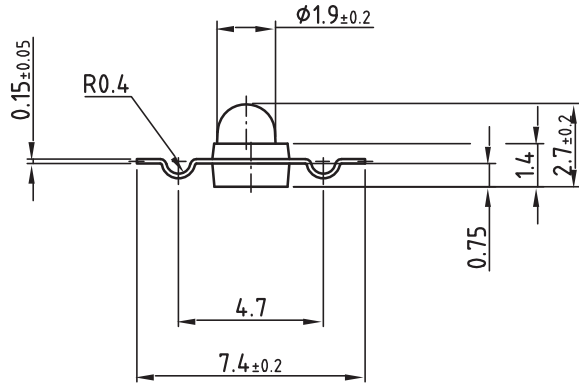

Drawing-No.: 6.544-5329.01-4

Issue: 4; 08.05.03

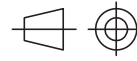

technical drawings according to DIN specifications

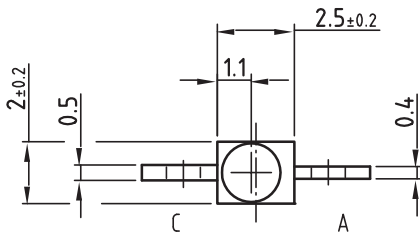

Solder pad proposal

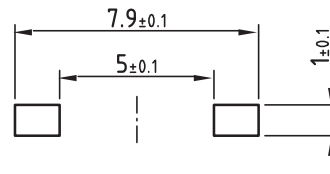

16228

REEL DIMENSIONS in millimeters

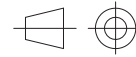
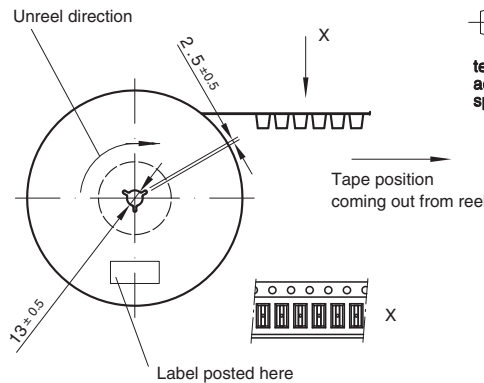
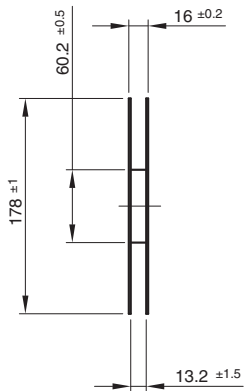

technical drawings according to DIN specifications

Leader and trailer tape:

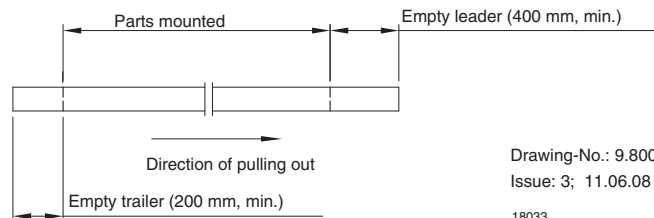

Drawing-No.: 9.800-5080.01-4

Issue: 3; 11.06.08

18033



TAPING DIMENSIONS in millimeters: TSMF1000

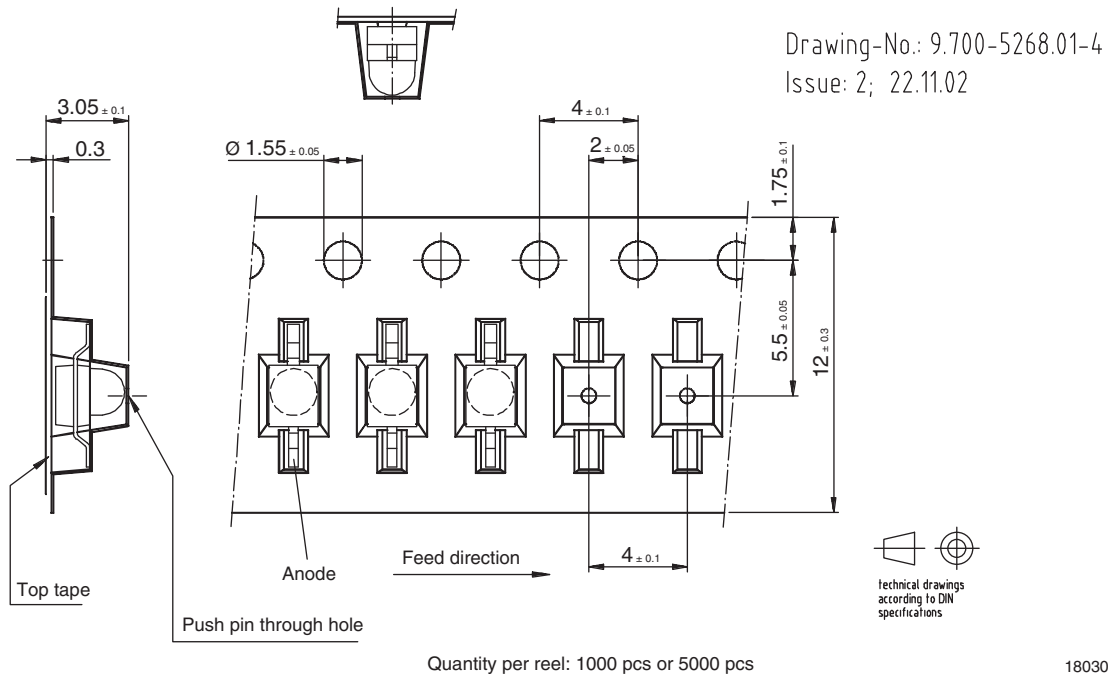

TAPING DIMENSIONS in millimeters: TSMF1020

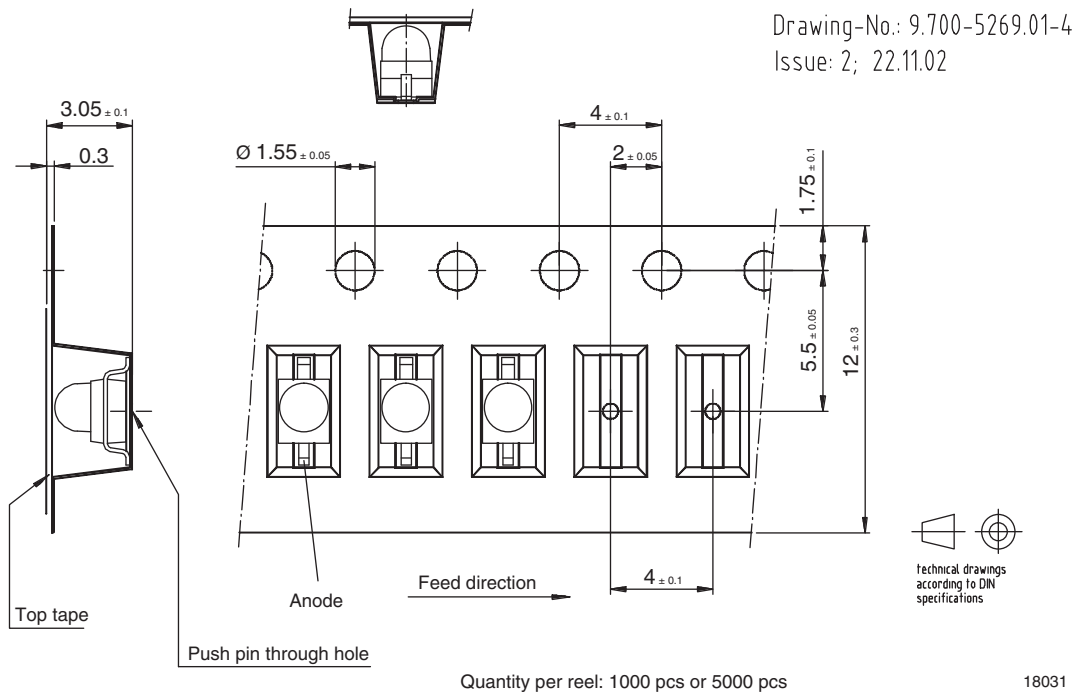



TAPING DIMENSIONS in millimeters: TSMF1030

Drawing-No.: 9.700-5270.01-4

Issue: 2; 22.11.02

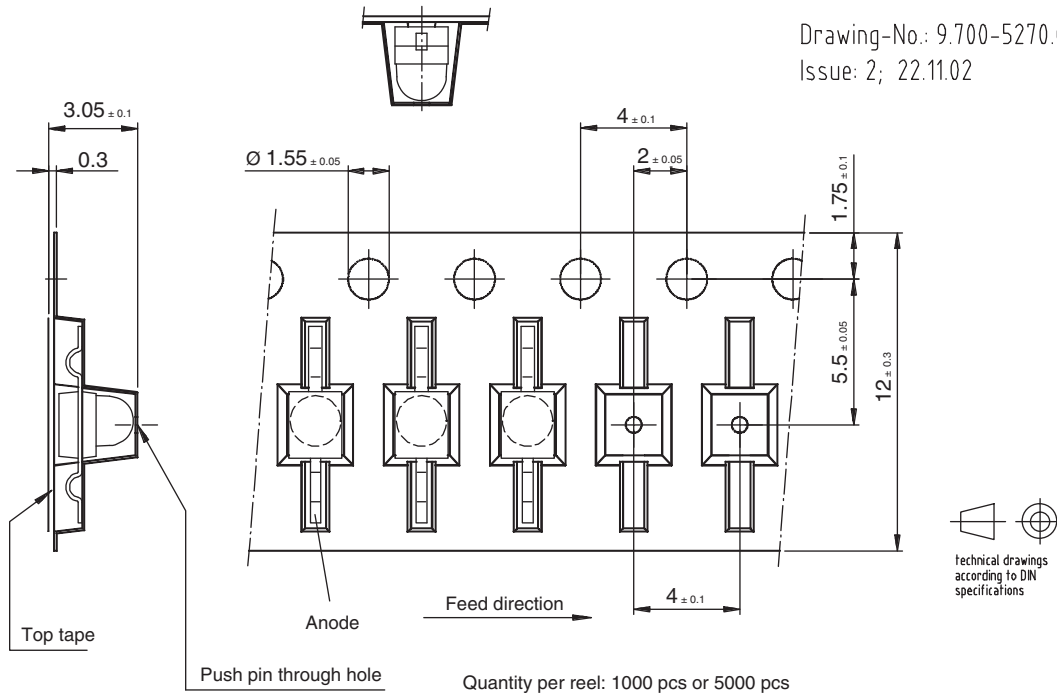

18032



Disclaimer

ALL PRODUCT, PRODUCT SPECIFICATIONS AND DATA ARE SUBJECT TO CHANGE WITHOUT NOTICE TO IMPROVE RELIABILITY, FUNCTION OR DESIGN OR OTHERWISE.

Vishay Intertechnology, Inc., its affiliates, agents, and employees, and all persons acting on its or their behalf (collectively, "Vishay"), disclaim any and all liability for any errors, inaccuracies or incompleteness contained in any datasheet or in any other disclosure relating to any product.

Vishay makes no warranty, representation or guarantee regarding the suitability of the products for any particular purpose or the continuing production of any product. To the maximum extent permitted by applicable law, Vishay disclaims (i) any and all liability arising out of the application or use of any product, (ii) any and all liability, including without limitation special, consequential or incidental damages, and (iii) any and all implied warranties, including warranties of fitness for particular purpose, non-infringement and merchantability.

Statements regarding the suitability of products for certain types of applications are based on Vishay's knowledge of typical requirements that are often placed on Vishay products in generic applications. Such statements are not binding statements about the suitability of products for a particular application. It is the customer's responsibility to validate that a particular product with the properties described in the product specification is suitable for use in a particular application. Parameters provided in datasheets and/or specifications may vary in different applications and performance may vary over time. All operating parameters, including typical parameters, must be validated for each customer application by the customer's technical experts. Product specifications do not expand or otherwise modify Vishay's terms and conditions of purchase, including but not limited to the warranty expressed therein.

Except as expressly indicated in writing, Vishay products are not designed for use in medical, life-saving, or life-sustaining applications or for any other application in which the failure of the Vishay product could result in personal injury or death. Customers using or selling Vishay products not expressly indicated for use in such applications do so at their own risk. Please contact authorized Vishay personnel to obtain written terms and conditions regarding products designed for such applications.

No license, express or implied, by estoppel or otherwise, to any intellectual property rights is granted by this document or by any conduct of Vishay. Product names and markings noted herein may be trademarks of their respective owners.

Material Category Policy

Vishay Intertechnology, Inc. hereby certifies that all its products that are identified as RoHS-Compliant fulfill the definitions and restrictions defined under Directive 2011/65/EU of The European Parliament and of the Council of June 8, 2011 on the restriction of the use of certain hazardous substances in electrical and electronic equipment (EEE) - recast, unless otherwise specified as non-compliant.

Please note that some Vishay documentation may still make reference to RoHS Directive 2002/95/EC. We confirm that all the products identified as being compliant to Directive 2002/95/EC conform to Directive 2011/65/EU.

Vishay Intertechnology, Inc. hereby certifies that all its products that are identified as Halogen-Free follow Halogen-Free requirements as per JEDEC JS709A standards. Please note that some Vishay documentation may still make reference to the IEC 61249-2-21 definition. We confirm that all the products identified as being compliant to IEC 61249-2-21 conform to JEDEC JS709A standards.

Компания «Океан Электроники» предлагает заключение долгосрочных отношений при поставках импортных электронных компонентов на взаимовыгодных условиях!

Наши преимущества:

- Поставка оригинальных импортных электронных компонентов напрямую с производств Америки, Европы и Азии, а так же с крупнейших складов мира;
- Широкая линейка поставок активных и пассивных импортных электронных компонентов (более 30 млн. наименований);
- Поставка сложных, дефицитных, либо снятых с производства позиций;
- Оперативные сроки поставки под заказ (от 5 рабочих дней);
- Экспресс доставка в любую точку России;
- Помощь Конструкторского Отдела и консультации квалифицированных инженеров;
- Техническая поддержка проекта, помощь в подборе аналогов, поставка прототипов;
- Поставка электронных компонентов под контролем ВП;
- Система менеджмента качества сертифицирована по Международному стандарту ISO 9001;
- При необходимости вся продукция военного и аэрокосмического назначения проходит испытания и сертификацию в лаборатории (по согласованию с заказчиком);
- Поставка специализированных компонентов военного и аэрокосмического уровня качества (Xilinx, Altera, Analog Devices, Intersil, Interpoint, Microsemi, Actel, Aeroflex, Peregrine, VPT, Syfer, Eurofarad, Texas Instruments, MS Kennedy, Miteq, Cobham, E2V, MA-COM, Hittite, Mini-Circuits, General Dynamics и др.);

Компания «Океан Электроники» является официальным дистрибьютором и эксклюзивным представителем в России одного из крупнейших производителей разъемов военного и аэрокосмического назначения «JONHON», а так же официальным дистрибьютором и эксклюзивным представителем в России производителя высокотехнологичных и надежных решений для передачи СВЧ сигналов «FORSTAR».



JONHON

«JONHON» (основан в 1970 г.)

Разъемы специального, военного и аэрокосмического назначения:

(Применяются в военной, авиационной, аэрокосмической, морской, железнодорожной, горно- и нефтедобывающей отраслях промышленности)

«FORSTAR» (основан в 1998 г.)

ВЧ соединители, коаксиальные кабели, кабельные сборки и микроволновые компоненты:

(Применяются в телекоммуникациях гражданского и специального назначения, в средствах связи, РЛС, а так же военной, авиационной и аэрокосмической отраслях промышленности).



Телефон: 8 (812) 309-75-97 (многоканальный)

Факс: 8 (812) 320-03-32

Электронная почта: ocean@oceanchips.ru

Web: <http://oceanchips.ru/>

Адрес: 198099, г. Санкт-Петербург, ул. Калинина, д. 2, корп. 4, лит. А