

CBTD3306

Dual bus switch with level shifting

Rev. 9 — 15 November 2018

Product data sheet

1. General description

The CBTD3306 dual FET bus switch features independent line switches. Each switch is disabled when the associated output enable (\overline{nOE}) input is HIGH.

The CBTD3306 is characterized for operation from $-40\text{ }^{\circ}\text{C}$ to $+85\text{ }^{\circ}\text{C}$.

2. Features and benefits

- Designed to be used in 5 V to 3.3 V level shifting applications with internal diode
- $5\ \Omega$ switch connection between two ports
- TTL-compatible input levels
- Multiple package options
- Latch-up protection exceeds 100 mA per JESD78B
- ESD protection:
 - HBM JESD22-A114F exceeds 2000 V
 - CDM JESD22-C101E exceeds 1000 V

3. Ordering information

Table 1. Ordering information

Type number	Package		Version
	Name	Description	
CBTD3306PW	TSSOP8	plastic thin shrink small outline package; 8 leads; body width 4.4 mm	SOT530-1
CBTD3306GT	XSON8	plastic extremely thin small outline package; no leads; 8 terminals; body 1 x 1.95 x 0.5 mm	SOT833-1
CBTD3306GM	XQFN8	plastic, extremely thin quad flat package; no leads; 8 terminals; body 1.6 x 1.6 x 0.5 mm	SOT902-2

4. Marking

Table 2. Marking codes

Type number	Marking code
CBTD3306PW	D306
CBTD3306GT	W06
CBTD3306GM	W06

5. Functional diagram

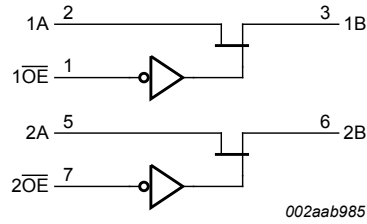

Fig. 1. Logic diagram

6. Pinning information

6.1. Pinning

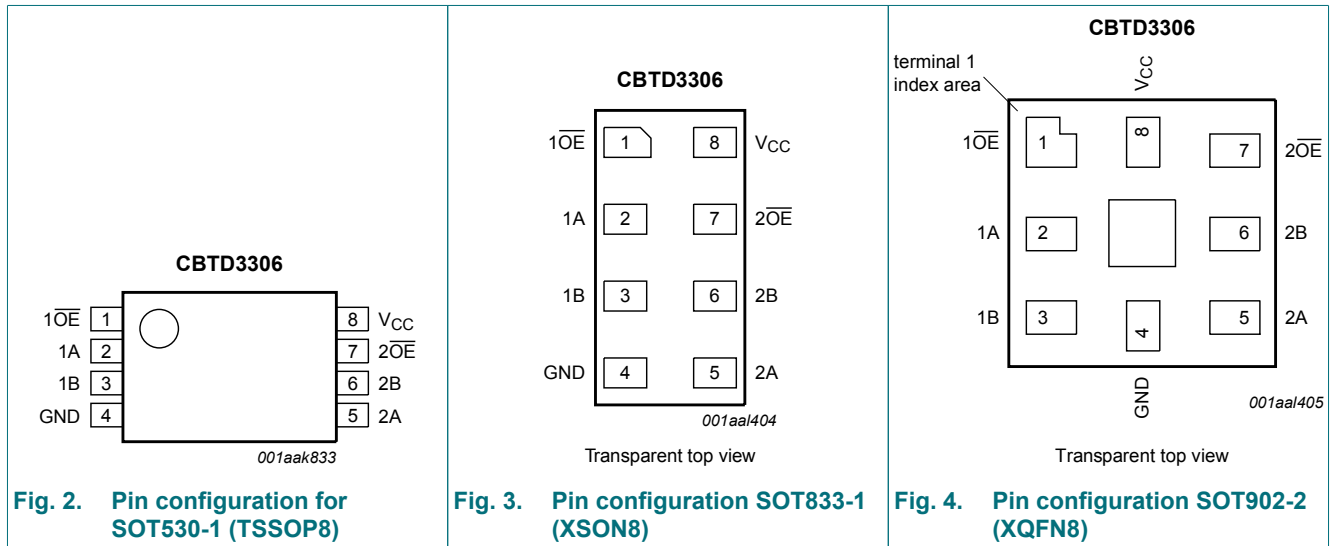

Fig. 2. Pin configuration for SOT530-1 (TSSOP8)

Fig. 3. Pin configuration SOT833-1 (XSON8)

Fig. 4. Pin configuration SOT902-2 (XQFN8)

6.2. Pin description

Table 3. Pin description

Symbol	Pin	Description
1OE, 2OE	1, 7	output enable input
1A, 2A	2, 5	data input/output (A port)
1B, 2B	3, 6	data input/output (B port)
GND	4	ground (0 V)
VCC	8	positive supply voltage

7. Functional description

Table 4. Function selection

H = HIGH voltage level; L = LOW voltage level; Z = high-impedance OFF-state.

Input	Input/output
nOE	nA, nB
L	nA = nB
H	Z

8. Limiting values

Table 5. Limiting values

In accordance with the Absolute Maximum Rating System (IEC 60134). [1]

T_{amb} = -40 °C to +85 °C, unless otherwise specified.

Symbol	Parameter	Conditions	Min	Max	Unit
V _{CC}	supply voltage		-0.5	+7.0	V
V _I	input voltage	[2]	-0.5	+7.0	V
I _{SW}	switch current		-	128	mA
I _{IK}	input clamping current	V _{I/O} = 0 V	-50	-	mA
T _{stg}	storage temperature		-65	+150	°C

- [1] Stresses beyond those listed may cause permanent damage to the device. These are stress ratings only and functional operation of the device at these or any other conditions beyond those indicated under Section 9. is not implied. Exposure to absolute-maximum-rated conditions for extended periods may affect device reliability.
- [2] The input and output negative-voltage ratings may be exceeded if the input and output clamp-current ratings are observed.

9. Recommended operating conditions

Table 6. Operating conditions

All unused control inputs of the device must be held at V_{CC} or GND to ensure proper device operation.

Symbol	Parameter	Conditions	Min	Typ	Max	Unit
V _{CC}	supply voltage		4.5	-	5.5	V
V _{IH}	HIGH-level input voltage		2.0	-	-	V
V _{IL}	LOW-level input voltage		-	-	0.8	V
T _{amb}	ambient temperature	operating in free air	-40	-	+85	°C

10. Static characteristics

Table 7. Static characteristics

Voltages are referenced to GND (ground = 0 V).

Symbol	Parameter	Conditions	T _{amb} = -40 °C to +85 °C			Unit
			Min	Typ [1]	Max	
V _{IK}	input clamping voltage	V _{CC} = 4.5 V; I _I = -18 mA	-	-	-1.2	V
I _I	input leakage current	V _{CC} = 5.5 V; V _I = GND or 5.5 V	-	-	±1	µA
I _{CC}	supply current	V _{CC} = 5.5 V; I _{SW} = 0 mA; V _I = V _{CC} or GND	-	-	1.5	mA
V _{pass}	pass voltage	see Fig. 5 to Fig. 9	-	-	-	V
ΔI _{CC}	additional supply current	per input pin; V _{CC} = 5.5 V; one input at 3.4 V, other inputs at V _{CC} or GND [2]	-	-	2.5	mA
C _I	input capacitance	control pin; V _I = 3 V or 0 V	-	3.2	-	pF
C _{io(off)}	off-state input/output capacitance	port off; V _I = 3 V or 0 V; nOE = V _{CC}	-	6.5	-	pF
R _{ON}	ON resistance	V _{CC} = 4.5 V; V _I = 0 V; I _I = 64 mA [3]	-	3.6	5	Ω
		V _{CC} = 4.5 V; V _I = 0 V; I _I = 30 mA [3]	-	3.6	5	Ω
		V _{CC} = 4.5 V; V _I = 2.4 V; I _I = 15 mA [3]	-	17	35	Ω

[1] All typical values are at V_{CC} = 5 V, T_{amb} = 25 °C.

[2] This is the increase in supply current for each input that is at the specified TTL voltage level rather than V_{CC} or GND.

[3] Measured by the voltage drop between the nA and the nB terminals at the indicated current through the switch. ON resistance is determined by the lowest voltage of the two (nA or nB) terminals.

10.1. Typical pass voltage graphs

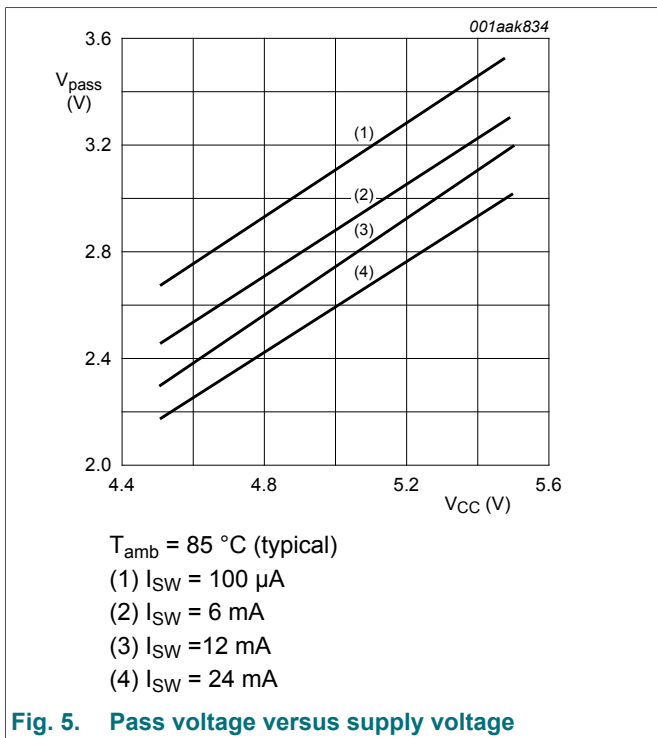

Fig. 5. Pass voltage versus supply voltage

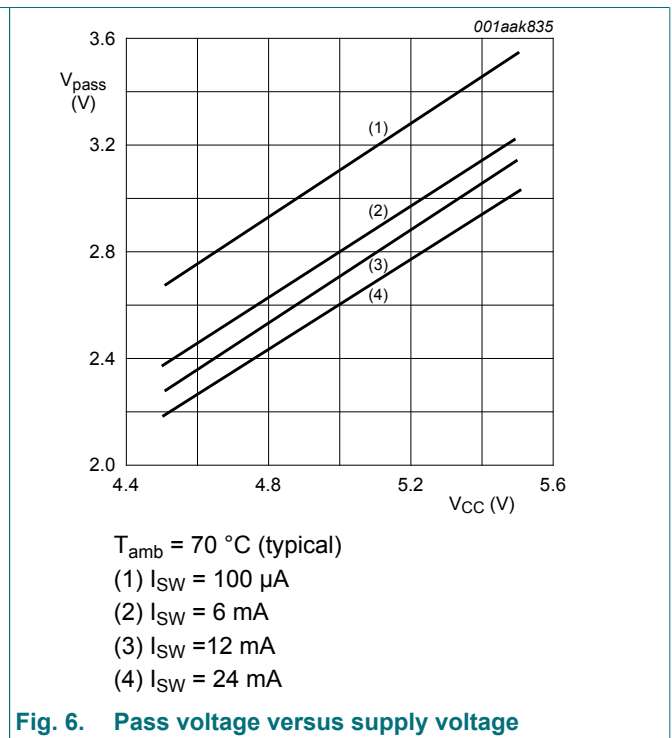

Fig. 6. Pass voltage versus supply voltage

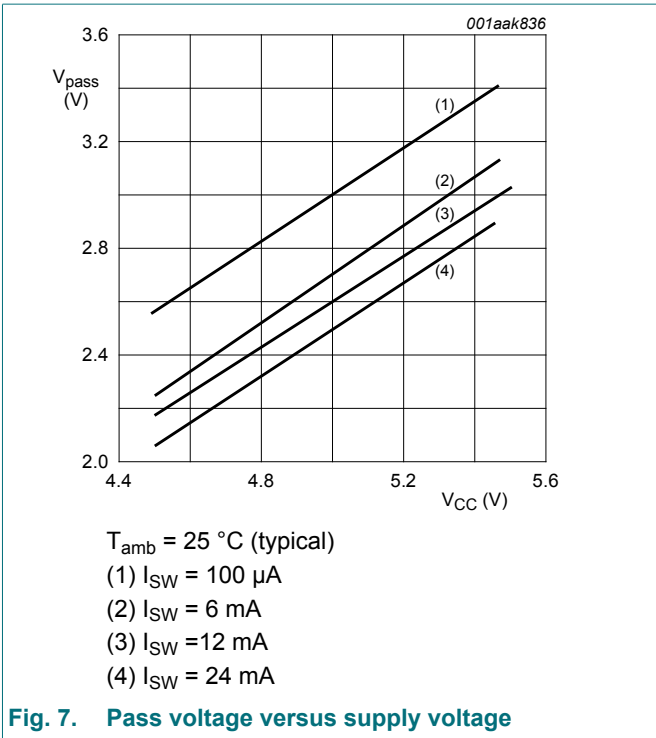

Fig. 7. Pass voltage versus supply voltage

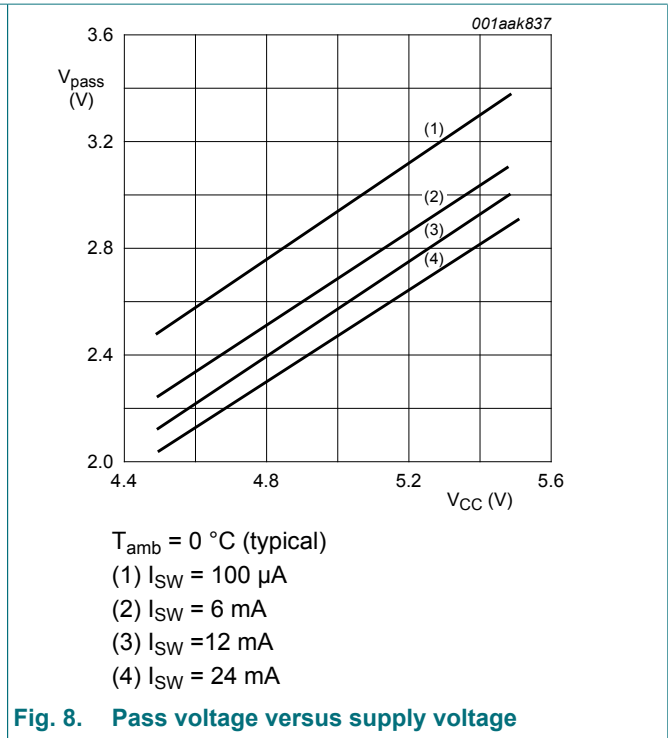

Fig. 8. Pass voltage versus supply voltage

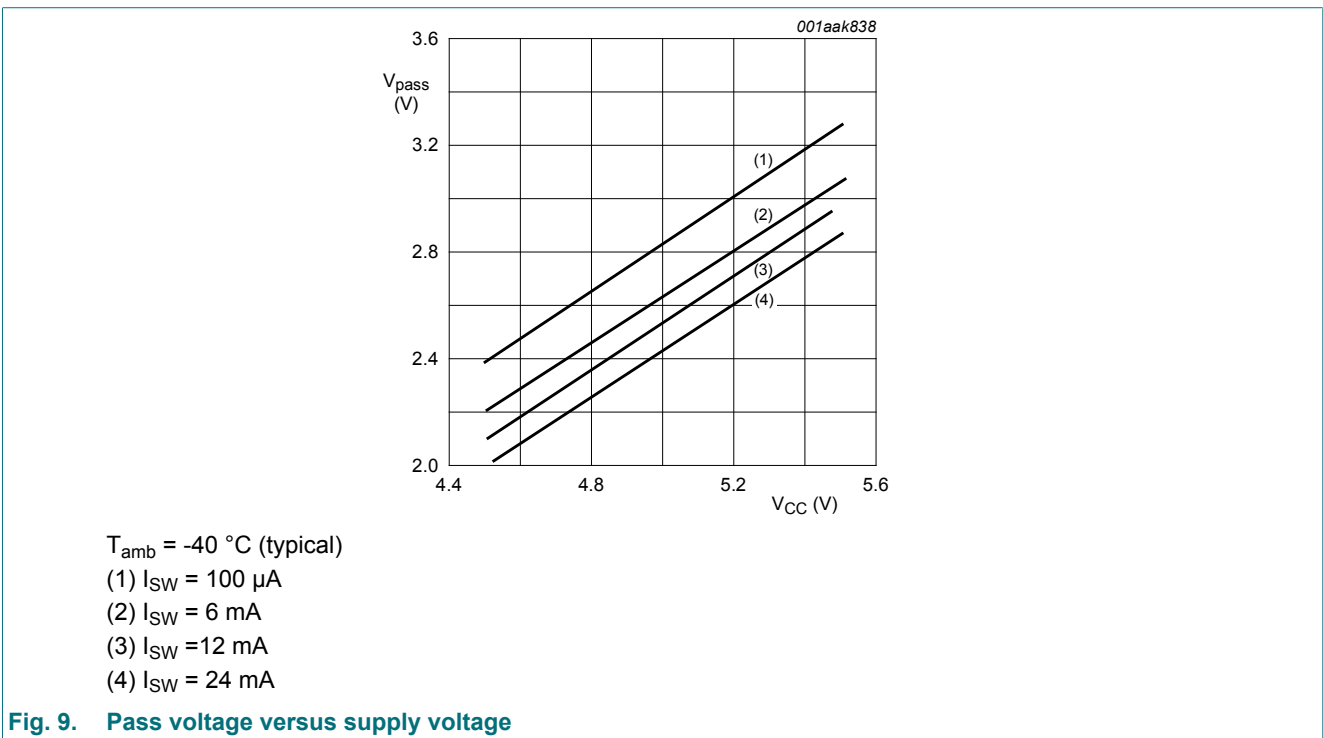

Fig. 9. Pass voltage versus supply voltage

11. Dynamic characteristics

Table 8. Dynamic characteristics

Voltages are referenced to GND (ground = 0 V). For test circuit see Fig. 12.

Symbol	Parameter	Conditions	T _{amb} = -40 °C to +85 °C			Unit
			Min	Typ	Max	
t _{pd}	propagation delay	nA, nB to nB, nA; see Fig. 10 [1][2] V _{CC} = 5.0 V ± 0.5 V	-	-	0.25	ns
t _{en}	enable time	n \overline{OE} to nA or nB; see Fig. 11 [2] V _{CC} = 5.0 V ± 0.5 V	1.0	-	5.4	ns
t _{dis}	disable time	n \overline{OE} to nA or nB; see Fig. 11 [2] V _{CC} = 5.0 V ± 0.5 V	1.0	-	4.9	ns

- [1] The propagation delay is the calculated RC time constant of the typical ON resistance of the switch and the specified load capacitance, when driven by an ideal voltage source (zero output impedance).
- [2] t_{pd} is the same as t_{PLH} and t_{PHL}; t_{en} is the same as t_{PZL} and t_{PZH}; t_{dis} is the same as t_{PLZ} and t_{PHZ}.

11.1. Waveforms and test circuit

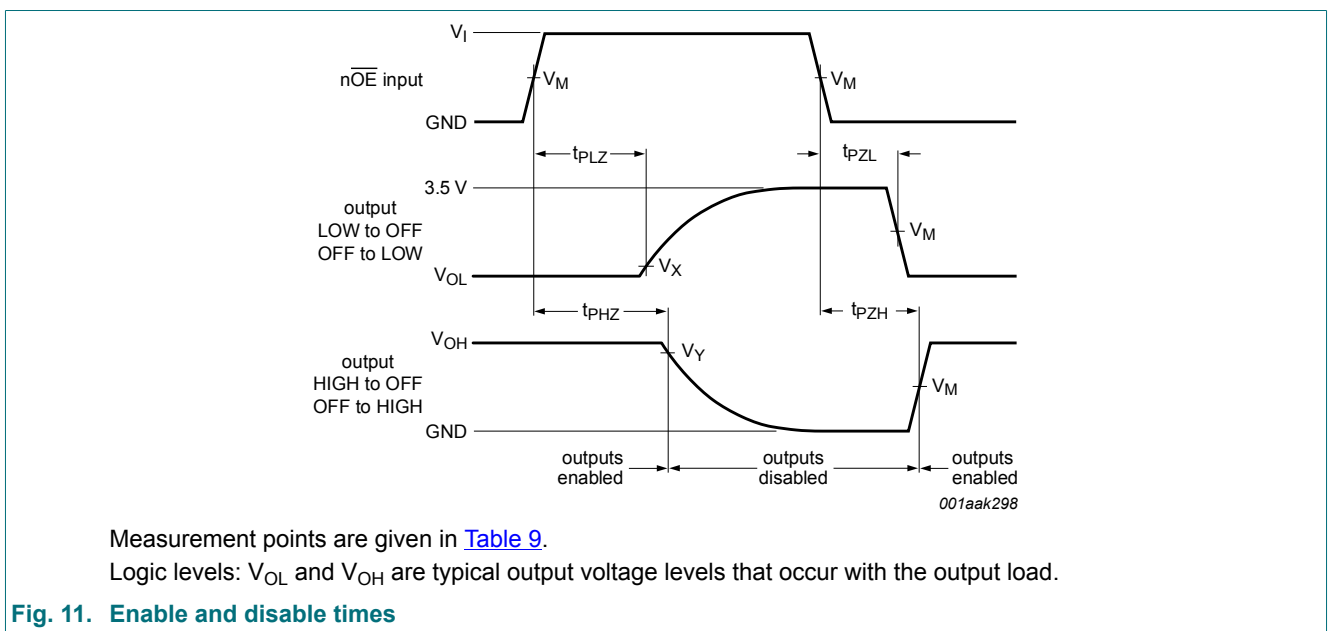
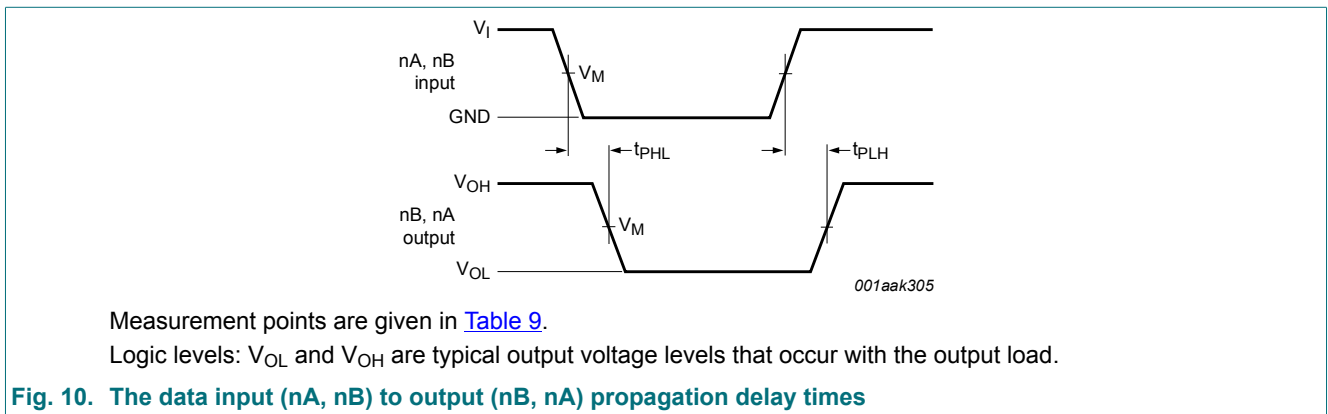
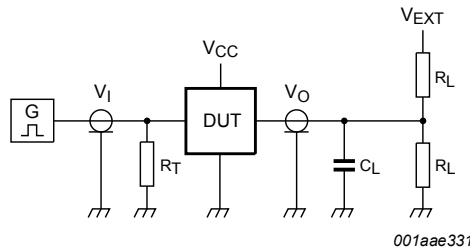
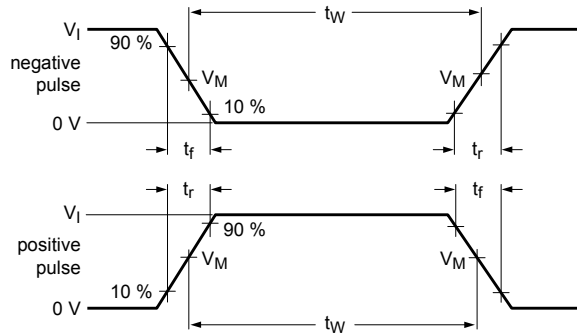

Table 9. Measurement points

Supply voltage	Input		Output		
V_{CC}	V_I	V_M	V_M	V_X	V_Y
$V_{CC} = 5.0\text{ V} \pm 0.5\text{ V}$	GND to 3.0 V	1.5 V	1.5 V	$V_{OL} + 0.3\text{ V}$	$V_{OH} - 0.3\text{ V}$



Test data is given in [Table 10](#).

All input pulses are supplied by generators having the following characteristics: PRR \leq 10 MHz; $Z_o = 50\ \Omega$.

The outputs are measured one at a time with one transition per measurement.

Definitions for test circuit:

R_L = Load resistance.

C_L = Load capacitance including jig and probe capacitance.

R_T = Termination resistance should be equal to output impedance Z_o of the pulse generator.

V_{EXT} = External voltage for measuring switching times.

Fig. 12. Test circuit for measuring switching times

Table 10. Test data

Supply voltage	Input		Load		V_{EXT}		
	V_I	t_r, t_f	C_L	R_L	t_{PLH}, t_{PHL}	t_{PLZ}, t_{PZL}	t_{PHZ}, t_{PZH}
$V_{CC} = 5.0\text{ V} \pm 0.5\text{ V}$	GND to 3.0 V	$\leq 2.5\text{ ns}$	50 pF	500 Ω	open	7.0 V	open

12. Package outline

TSSOP8: plastic thin shrink small outline package; 8 leads; body width 4.4 mm

SOT530-1

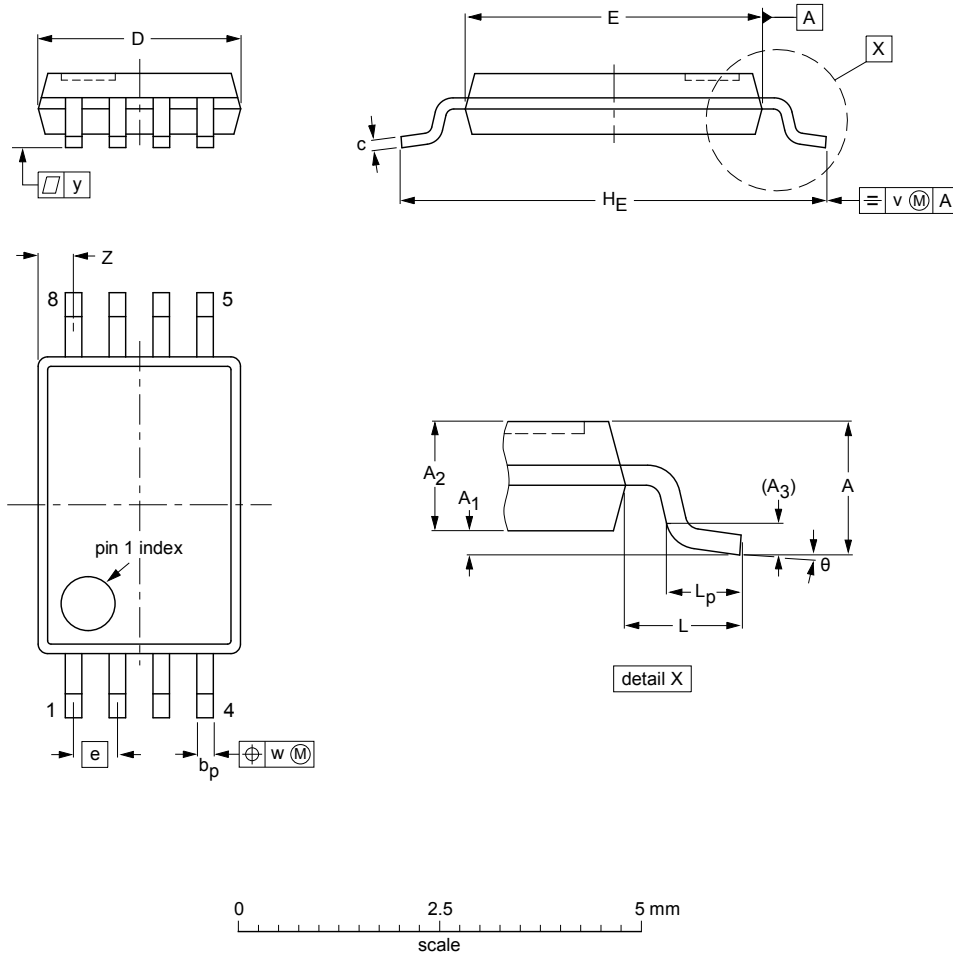

DIMENSIONS (mm are the original dimensions)

UNIT	A max.	A ₁	A ₂	A ₃	b _p	c	D ⁽¹⁾	E ⁽²⁾	e	H _E	L	L _p	v	w	y	Z ⁽¹⁾	θ
mm	1.1	0.15 0.05	0.95 0.85	0.25	0.30 0.19	0.20 0.13	3.1 2.9	4.5 4.3	0.65	6.5 6.3	0.94	0.7 0.5	0.1	0.1	0.1	0.70 0.35	8° 0°

Notes

1. Plastic or metal protrusions of 0.15 mm maximum per side are not included.
2. Plastic or metal protrusions of 0.25 mm maximum per side are not included.

OUTLINE VERSION	REFERENCES				EUROPEAN PROJECTION	ISSUE DATE
	IEC	JEDEC	JEITA			
SOT530-1		MO-153				00-02-24 03-02-18

Fig. 13. Package outline SOT530-1 (TSSOP8)

XSON8: plastic extremely thin small outline package; no leads; 8 terminals; body 1 x 1.95 x 0.5 mm

SOT833-1

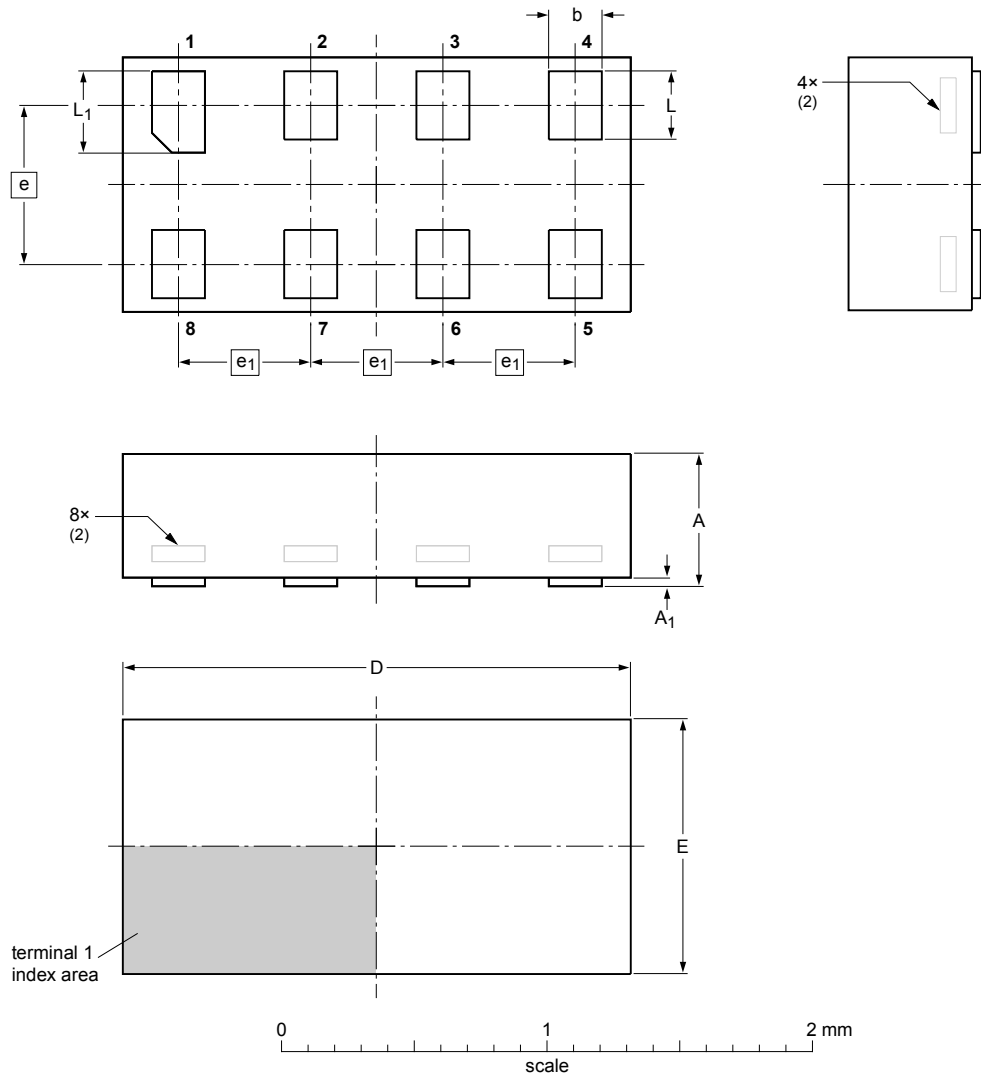

DIMENSIONS (mm are the original dimensions)

UNIT	A ⁽¹⁾ max	A ₁ max	b	D	E	e	e ₁	L	L ₁
mm	0.5	0.04	0.25 0.17	2.0 1.9	1.05 0.95	0.6	0.5	0.35 0.27	0.40 0.32

Notes

- Including plating thickness.
- Can be visible in some manufacturing processes.

OUTLINE VERSION	REFERENCES				EUROPEAN PROJECTION	ISSUE DATE
	IEC	JEDEC	JEITA			
SOT833-1	---	MO-252	---			-07-11-14- 07-12-07

Fig. 14. Package outline SOT833-1 (XSON8)

XQFN8: plastic, extremely thin quad flat package; no leads;
8 terminals; body 1.6 x 1.6 x 0.5 mm

SOT902-2

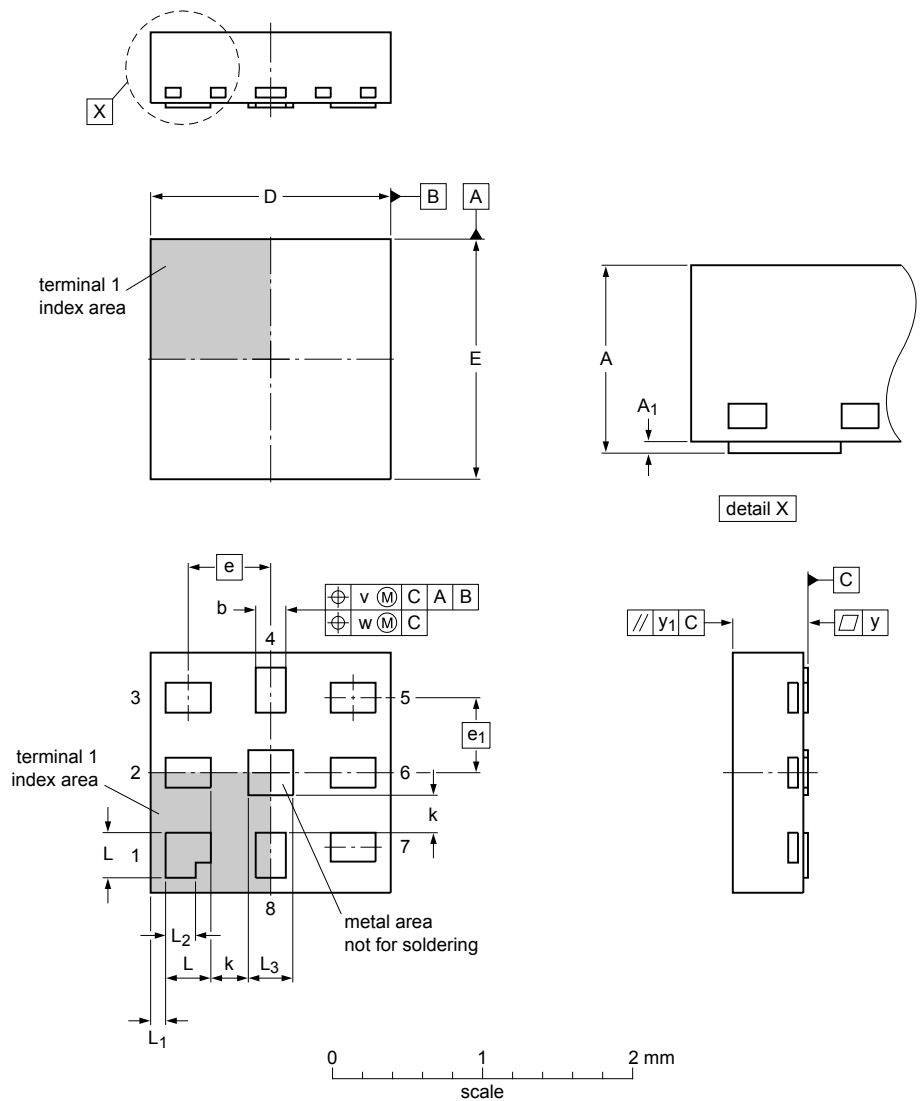

Dimensions

Unit ⁽¹⁾	A	A ₁	b	D	E	e	e ₁	k	L	L ₁	L ₂	L ₃	v	w	y	y ₁
max	0.5	0.05	0.25	1.65	1.65				0.35	0.15	0.25	0.35				
mm	nom		0.20	1.60	1.60	0.55	0.5		0.30	0.10	0.20	0.30	0.1	0.05	0.05	0.05
min		0.00	0.15	1.55	1.55			0.2	0.25	0.05	0.15	0.25				

Note

1. Plastic or metal protrusions of 0.075 mm maximum per side are not included.

sot902-2_po

Outline version	References			European projection	Issue date
	IEC	JEDEC	JEITA		
SOT902-2	---	MO-255	---		16-07-14 16-11-08

Fig. 15. Package outline SOT902-2 (XQFN8)

13. Abbreviations

Table 11. Abbreviations

Acronym	Description
CDM	Charged Device Model
ESD	ElectroStatic Discharge
FET	Field Effect Transistor
HBM	Human Body Model
PRR	Pulse Rate Repetition
TTL	Transistor-Transistor Logic

14. Revision history

Table 12. Revision history

Document ID	Release date	Data sheet status	Change notice	Supersedes
CBTD3306 v.9	20181115	Product data sheet	-	CBTD3306 v.8
Modifications:	<ul style="list-style-type: none"> The format of this data sheet has been redesigned to comply with the identity guidelines of Nexperia. Legal texts have been adapted to the new company name where appropriate. Type number CBTD3306D (SOT96-1/SO8) removed. 			
CBTD3306 v.8	20120501	Product data sheet	-	CBTD3306 v.7
Modifications:	<ul style="list-style-type: none"> For type number CBTD3306GM the SOT code has changed to SOT902-2. 			
CBTD3306 v.7	20120103	Product data sheet	-	CBTD3306 v.6
Modifications:	<ul style="list-style-type: none"> Marking code for type number CBTD3306D changed. 			
CBTD3306 v.6	20111121	Product data sheet	-	CBTD3306 v.5
Modifications:	<ul style="list-style-type: none"> Legal pages updated. 			
CBTD3306 v.5	20110428	Product data sheet	-	CBTD3306 v.4
CBTD3306 v.4	20100325	Product data sheet	-	CBTD3306 v.3
CBTD3306 v.3	20100223	Product data sheet	-	CBTD3306 v.2
CBTD3306 v.2	20091015	Product data sheet	-	CBTD3306 v.1
CBTD3306 v.1	20011108	Product data	-	-

15. Legal information

Data sheet status

Document status [1][2]	Product status [3]	Definition
Objective [short] data sheet	Development	This document contains data from the objective specification for product development.
Preliminary [short] data sheet	Qualification	This document contains data from the preliminary specification.
Product [short] data sheet	Production	This document contains the product specification.

- [1] Please consult the most recently issued document before initiating or completing a design.
- [2] The term 'short data sheet' is explained in section "Definitions".
- [3] The product status of device(s) described in this document may have changed since this document was published and may differ in case of multiple devices. The latest product status information is available on the internet at <https://www.nexperia.com>.

Definitions

Draft — The document is a draft version only. The content is still under internal review and subject to formal approval, which may result in modifications or additions. Nexperia does not give any representations or warranties as to the accuracy or completeness of information included herein and shall have no liability for the consequences of use of such information.

Short data sheet — A short data sheet is an extract from a full data sheet with the same product type number(s) and title. A short data sheet is intended for quick reference only and should not be relied upon to contain detailed and full information. For detailed and full information see the relevant full data sheet, which is available on request via the local Nexperia sales office. In case of any inconsistency or conflict with the short data sheet, the full data sheet shall prevail.

Product specification — The information and data provided in a Product data sheet shall define the specification of the product as agreed between Nexperia and its customer, unless Nexperia and customer have explicitly agreed otherwise in writing. In no event however, shall an agreement be valid in which the Nexperia product is deemed to offer functions and qualities beyond those described in the Product data sheet.

Disclaimers

Limited warranty and liability — Information in this document is believed to be accurate and reliable. However, Nexperia does not give any representations or warranties, expressed or implied, as to the accuracy or completeness of such information and shall have no liability for the consequences of use of such information. Nexperia takes no responsibility for the content in this document if provided by an information source outside of Nexperia.

In no event shall Nexperia be liable for any indirect, incidental, punitive, special or consequential damages (including - without limitation - lost profits, lost savings, business interruption, costs related to the removal or replacement of any products or rework charges) whether or not such damages are based on tort (including negligence), warranty, breach of contract or any other legal theory.

Notwithstanding any damages that customer might incur for any reason whatsoever, Nexperia's aggregate and cumulative liability towards customer for the products described herein shall be limited in accordance with the Terms and conditions of commercial sale of Nexperia.

Right to make changes — Nexperia reserves the right to make changes to information published in this document, including without limitation specifications and product descriptions, at any time and without notice. This document supersedes and replaces all information supplied prior to the publication hereof.

Suitability for use — Nexperia products are not designed, authorized or warranted to be suitable for use in life support, life-critical or safety-critical systems or equipment, nor in applications where failure or malfunction of an Nexperia product can reasonably be expected to result in personal

injury, death or severe property or environmental damage. Nexperia and its suppliers accept no liability for inclusion and/or use of Nexperia products in such equipment or applications and therefore such inclusion and/or use is at the customer's own risk.

Quick reference data — The Quick reference data is an extract of the product data given in the Limiting values and Characteristics sections of this document, and as such is not complete, exhaustive or legally binding.

Applications — Applications that are described herein for any of these products are for illustrative purposes only. Nexperia makes no representation or warranty that such applications will be suitable for the specified use without further testing or modification.

Customers are responsible for the design and operation of their applications and products using Nexperia products, and Nexperia accepts no liability for any assistance with applications or customer product design. It is customer's sole responsibility to determine whether the Nexperia product is suitable and fit for the customer's applications and products planned, as well as for the planned application and use of customer's third party customer(s). Customers should provide appropriate design and operating safeguards to minimize the risks associated with their applications and products.

Nexperia does not accept any liability related to any default, damage, costs or problem which is based on any weakness or default in the customer's applications or products, or the application or use by customer's third party customer(s). Customer is responsible for doing all necessary testing for the customer's applications and products using Nexperia products in order to avoid a default of the applications and the products or of the application or use by customer's third party customer(s). Nexperia does not accept any liability in this respect.

Limiting values — Stress above one or more limiting values (as defined in the Absolute Maximum Ratings System of IEC 60134) will cause permanent damage to the device. Limiting values are stress ratings only and (proper) operation of the device at these or any other conditions above those given in the Recommended operating conditions section (if present) or the Characteristics sections of this document is not warranted. Constant or repeated exposure to limiting values will permanently and irreversibly affect the quality and reliability of the device.

Terms and conditions of commercial sale — Nexperia products are sold subject to the general terms and conditions of commercial sale, as published at <http://www.nexperia.com/profile/terms>, unless otherwise agreed in a valid written individual agreement. In case an individual agreement is concluded only the terms and conditions of the respective agreement shall apply. Nexperia hereby expressly objects to applying the customer's general terms and conditions with regard to the purchase of Nexperia products by customer.

No offer to sell or license — Nothing in this document may be interpreted or construed as an offer to sell products that is open for acceptance or the grant, conveyance or implication of any license under any copyrights, patents or other industrial or intellectual property rights.

Export control — This document as well as the item(s) described herein may be subject to export control regulations. Export might require a prior authorization from competent authorities.

Non-automotive qualified products — Unless this data sheet expressly states that this specific Nexperia product is automotive qualified, the product is not suitable for automotive use. It is neither qualified nor tested in accordance with automotive testing or application requirements. Nexperia accepts no liability for inclusion and/or use of non-automotive qualified products in automotive equipment or applications.

In the event that customer uses the product for design-in and use in automotive applications to automotive specifications and standards, customer (a) shall use the product without Nexperia's warranty of the product for such automotive applications, use and specifications, and (b) whenever customer uses the product for automotive applications beyond Nexperia's specifications such use shall be solely at customer's own risk, and (c) customer fully indemnifies Nexperia for any liability, damages or failed product claims resulting from customer design and use of the product for automotive applications beyond Nexperia's standard warranty and Nexperia's product specifications.

Translations — A non-English (translated) version of a document is for reference only. The English version shall prevail in case of any discrepancy between the translated and English versions.

Trademarks

Notice: All referenced brands, product names, service names and trademarks are the property of their respective owners.

Contents

1. General description	1
2. Features and benefits	1
3. Ordering information	1
4. Marking	1
5. Functional diagram	2
6. Pinning information	2
6.1. Pinning.....	2
6.2. Pin description.....	2
7. Functional description	3
8. Limiting values	3
9. Recommended operating conditions	3
10. Static characteristics	4
10.1. Typical pass voltage graphs.....	4
11. Dynamic characteristics	6
11.1. Waveforms and test circuit.....	6
12. Package outline	8
13. Abbreviations	11
14. Revision history	11
15. Legal information	12

© Nexperia B.V. 2018. All rights reserved

For more information, please visit: <http://www.nexperia.com>
For sales office addresses, please send an email to: salesaddresses@nexperia.com
Date of release: 15 November 2018

Компания «Океан Электроники» предлагает заключение долгосрочных отношений при поставках импортных электронных компонентов на взаимовыгодных условиях!

Наши преимущества:

- Поставка оригинальных импортных электронных компонентов напрямую с производств Америки, Европы и Азии, а так же с крупнейших складов мира;
- Широкая линейка поставок активных и пассивных импортных электронных компонентов (более 30 млн. наименований);
- Поставка сложных, дефицитных, либо снятых с производства позиций;
- Оперативные сроки поставки под заказ (от 5 рабочих дней);
- Экспресс доставка в любую точку России;
- Помощь Конструкторского Отдела и консультации квалифицированных инженеров;
- Техническая поддержка проекта, помощь в подборе аналогов, поставка прототипов;
- Поставка электронных компонентов под контролем ВП;
- Система менеджмента качества сертифицирована по Международному стандарту ISO 9001;
- При необходимости вся продукция военного и аэрокосмического назначения проходит испытания и сертификацию в лаборатории (по согласованию с заказчиком);
- Поставка специализированных компонентов военного и аэрокосмического уровня качества (Xilinx, Altera, Analog Devices, Intersil, Interpoint, Microsemi, Actel, Aeroflex, Peregrine, VPT, Syfer, Eurofarad, Texas Instruments, MS Kennedy, Miteq, Cobham, E2V, MA-COM, Hittite, Mini-Circuits, General Dynamics и др.);

Компания «Океан Электроники» является официальным дистрибьютором и эксклюзивным представителем в России одного из крупнейших производителей разъемов военного и аэрокосмического назначения «**JONHON**», а так же официальным дистрибьютором и эксклюзивным представителем в России производителя высокотехнологичных и надежных решений для передачи СВЧ сигналов «**FORSTAR**».



JONHON

«**JONHON**» (основан в 1970 г.)

Разъемы специального, военного и аэрокосмического назначения:

(Применяются в военной, авиационной, аэрокосмической, морской, железнодорожной, горно- и нефтедобывающей отраслях промышленности)

«**FORSTAR**» (основан в 1998 г.)

ВЧ соединители, коаксиальные кабели,
кабельные сборки и микроволновые компоненты:

(Применяются в телекоммуникациях гражданского и специального назначения, в средствах связи, РЛС, а так же военной, авиационной и аэрокосмической отраслях промышленности).



Телефон: 8 (812) 309-75-97 (многоканальный)

Факс: 8 (812) 320-03-32

Электронная почта: ocean@oceanchips.ru

Web: <http://oceanchips.ru/>

Адрес: 198099, г. Санкт-Петербург, ул. Калинина, д. 2, корп. 4, лит. А