

# Snap Action Switch

# V

## General Purpose Snap Action Switch

- Industry standard design with switching currents of 10A to 21A
- Widely used for applications where long life expectancy and high reliability is required.
- Choose from a variety of levers, terminals and operating forces.
- Right and Left Barrier options are available for the V-21 and V-16 models
- Heat resistant versions of the V-15 and V-10 are available.
- RoHS Compliant



## Ordering Information

### Model Number Legend

V -          -             -    -   

1    2    3    4    5    6    7    8    9

#### 1. Ratings

21: 21 A at 250 VAC  
 16: 16 A at 250 VAC  
 15: 15 A at 250 VAC  
 11: 11 A at 250 VAC  
 10: 10 A at 250 VAC

#### 2. Contact Gap

None: 1 mm (F gap)  
 G: 0.5 mm (G gap)

#### 3. Actuator

None: Pin plunger  
 1: Short hinge lever  
 2: Hinge lever  
 3: Long hinge lever  
 4: Simulated roller lever  
 5: Short hinge roller lever  
 6: Hinge roller lever

#### 4. Contact Form

COM Terminal, Bottom position:

1: SPDT  
 2: SPST-NC  
 3: SPST-NO

COM Terminal, Side position:

4: SPDT  
 5: SPST-NC  
 6: SPST-NO

#### 5. Terminals

A: Solder terminals  
 C2: Quick-connect terminal (#187)  
 C: Quick-connect terminal (#250)

#### 6. Insulation Barrier

None: Without Barrier  
 R: Right-hand barrier  
 L: Left-hand barrier  
 (Barriers available for V-21 and V-16, only)

#### 7. Maximum Operating Force

6: 400 gf  
 5: 200 gf  
 4: 100 gf

**Note:** These OF values are for the pin plunger models.

#### 8. Special Purpose

None: Standard  
 T: Heat resistive  
 (V-15 and V-10, only)

#### 9. Mounting Hole Size

None: 3.1 mm  
 K: 2.9 mm

**Note:** Consult Omron regarding nomenclature combinations and part numbers not found in this datasheet.

## Available Combinations

COM terminal position	Insulation Barrier	Heat Resistance	Model Rated Current OF Terminal Symbol	Thermoplastic case				Thermosetting case			
				V-21 21 A	V-16 16 A		V-11 11 A	V-15 15 A		V-10 10 A	
				400 gf	400 gf	200 gf	100 gf	400 gf	200 gf	200 gf	100 gf
Bottom	No	Standard (80°C)	Solder terminals (A)	---	○	○	○	○	○	○	○
			Quick-connect terminals (#187)(C2)	---	○	○	○	○	○	○	○
			Quick-connect terminals (#250)(C)	○	○	○	○	○	○	○	○
		Heat resistant (150°C)	Solder terminals (A)	---	---	---	---	○	○	○	○
			Quick-connect terminals (#187)(C2)	---	---	---	---	○	○	○	○
			Quick-connect terminals (#250)(C)	---	---	---	---	---	---	---	---
	Yes	Standard (80°C)	Solder terminals (A)	---	○	○	---	---	---	---	---
			Quick-connect terminals (#187)(C2)	---	○	○	---	---	---	---	---
			Quick-connect terminals (#250)(C)	○	○	○	---	---	---	---	---
Side	No	Standard (80°C)	Solder terminals (A)	---	---	---	---	○	○	○	○
			Quick-connect terminals (#187)(C2)	---	---	---	---	○	○	○	○
			Quick-connect terminals (#250)(C)	○	---	---	---	---	---	---	---

Note: 1. ○: Available model.

Consult OMRON for specific models with standard approval.

## List of Models

### Thermoplastic Case

#### 21 A (OF: 400 gf)

Common terminal position	Contact form	Terminal style	Actuator	Without barrier	Right-hand barrier	Left-hand barrier	
							
Bottom	SPDT	Quick-connect (#250) (C)	Pin plunger 	V-21-1C6	V-21-1CR6	V-21-1CL6	
	SPST-NC			V-21-2C6	V-21-2CR6	V-21-2CL6	
	SPST-NO			V-21-3C6	V-21-3CR6	V-21-3CL6	
	SPDT		Short hinge lever 	V-211-1C6	V-211-1CR6	V-211-1CL6	
				Hinge lever 	V-212-1C6	V-212-1CR6	V-212-1CL6
					Long hinge lever 	V-213-1C6	V-213-1CR6
				Simulated roller lever 	V-214-1C6	V-214-1CR6	V-214-1CL6
				Short hinge roller lever 	V-215-1C6	V-215-1CR6	V-215-1CL6
Hinge roller lever 	V-216-1C6	V-216-1CR6	V-216-1CL6				

Note: 1. Add "G" to the part number in the appropriate location to obtain a 0.5 mm contact gap. Add "K" to the part number in the appropriate location to obtain 2.9 mm mounting holes. Example: V-21 G2-1C6-K

2. Not all combinations are available. Consult Omron regarding nomenclature combinations and part numbers not found in this datasheet.

16 A (OF: 200 gf)

Common terminal position	Contact form	Terminal style	Actuator	Without barrier	Right-hand barrier	Left-hand barrier			
									
Bottom	SPDT	A	Pin plunger 	V-16-1A5	V-16-1AR5	V-16-1AL5			
				V-16-1C25	V-16-1C2R5	V-16-1C2L5			
				V-16-1C5	---	---			
		C2		A	V-16-2A5	V-16-2AR5	V-16-2AL5		
					V-16-2C25	V-16-2C2R5	V-16-2C2L5		
					V-16-2C5	---	---		
		C		A	V-16-3A5	V-16-3AR5	V-16-3AL5		
					V-16-3C25	V-16-3C2R5	V-16-3C2L5		
					V-16-3C5	---	---		
	SPDT	A	C2	Short hinge lever 	V-161-1A5	V-161-1AR5	V-161-1AL5		
					V-161-1C25	V-161-1C2R5	V-161-1C2L5		
					V-161-1C5	---	---		
			C		A	Hinge lever 	V-162-1A5	V-162-1AR5	V-162-1AL5
							V-162-1C25	V-162-1C2R5	V-162-1C2L5
							V-162-1C5	---	---
			A		C2	Long hinge lever 	V-163-1A5	V-163-1AR5	V-163-1AL5
							V-163-1C25	V-163-1C2R5	V-163-1C2L5
							V-163-1C5	---	---
		C	A	Simulated roller lever 	V-164-1A5	V-164-1AR5	V-164-1AL5		
					V-164-1C25	V-164-1C2R5	V-164-1C2L5		
					V-164-1C5	---	---		
		A	C2	Short hinge roller lever 	V-165-1A5	V-165-1AR5	V-165-1AL5		
					V-165-1C25	V-165-1C2R5	V-165-1C2L5		
					V-165-1C5	---	---		
C		A	Hinge roller lever 	V-166-1A5	V-166-1AR5	V-166-1AL5			
				V-166-1C25	V-166-1C2R5	V-166-1C2L5			
				V-166-1C5	---	---			







11 A (OF: 100 gf)

Common terminal position	Contact form	Terminal style	Actuator	Without barrier		
						
Bottom	SPDT	A	Pin plunger 	V-11-1A4		
				V-11-1C24		
				V-11-1C4		
		C2		A	Short hinge lever 	V-111-1A4
						V-111-1C24
						V-111-1C4
		C		A	Hinge lever 	V-112-1A4
						V-112-1C24
						V-112-1C4
		A		C2	Long hinge lever 	V-113-1A4
						V-113-1C24
						V-113-1C4
		C		A	Simulated roller lever 	V-114-1A4
						V-114-1C24
						V-114-1C4
		A		C2	Short hinge roller lever 	V-115-1A4
						V-115-1C24
						V-115-1C4
		C		A	Hinge roller lever 	V-116-1A4
						V-116-1C24
						V-116-1C4

- Note:** 1. Add "G" to the part number in the appropriate location to obtain a 0.5 mm contact gap. Add "-K" to the part number in the appropriate location to obtain 2.9 mm mounting holes. Examples: 1) V-16G3-1C25-K 2) V-11G-1A4-K  
 2. Not all combinations are available. Consult Omron regarding nomenclature combinations and part numbers not found in this datasheet.

## Thermosetting Case

### Standard models - 15 A / 10 A

Common terminal position	Contact form	Terminal style	Actuator	15 A	10 A	
				200 gf	200 gf	100 gf
Bottom	SPDT	A	Pin plunger 	V-15G-1A5-K	V-10G-1A5-K	V-10G-1A4-K
		C2		V-15G-1C25-K	V-10G-1C25-K	V-10G-1C24-K
		C		V-15G-1C5-K	—	—
	SPST-NC	A		V-15G-2A5-K	V-10G-2A5-K	V-10G-2A4-K
		C2		V-15G-2C25-K	V-10G-2C25-K	V-10G-2C24-K
		C		V-15G-3A5-K	V-10G-3A5-K	V-10G-3A4-K
	SPST-NO	A		V-15G-3C25-K	V-10G-3C25-K	V-10G-3C24-K
		C2		V-15G-3C5-K	—	—
		C		V-15G-4A5-K	V-10G-4A5-K	V-10G-4A4-K
Side	SPDT	A	V-15G-5A5-K	V-10G-5A5-K	V-10G-5A4-K	
	SPST-NC		V-15G-6A5-K	V-10G-6A5-K	V-10G-6A4-K	
	SPST-NO					
Bottom	SPDT	A	Short hinge lever 	V-15G1-1A5-K	V-10G1-1A5-K	V-10G1-1A4-K
		C2		V-15G1-1C25-K	V-10G1-1C25-K	V-10G1-1C24-K
		A	Hinge lever 	V-15G2-1A5-K	V-10G2-1A5-K	V-10G2-1A4-K
		C2		V-15G2-1C25-K	V-10G2-1C25-K	V-10G2-1C24-K
		A	Long hinge lever 	V-15G3-1A5-K	V-10G3-1A5-K	V-10G3-1A4-K
		C2		V-15G3-1C25-K	V-10G3-1C25-K	V-10G3-1C24-K
		A	Simulated roller lever 	V-15G4-1A5-K	V-10G4-1A5-K	V-10G4-1A4-K
		C2		V-15G4-1C25-K	V-10G4-1C25-K	V-10G4-1C24-K
		A	Short hinge roller lever 	V-15G5-1A5-K	V-10G5-1A5-K	V-10G5-1A4-K
		C2		V-15G5-1C25-K	V-10G5-1C25-K	V-10G5-1C24-K
		A	Hinge roller lever 	V-15G6-1A5-K	V-10G6-1A5-K	V-10G6-1A4-K
		C2		V-15G6-1C25-K	—	V-10G6-1C24-K

Note: 1. For SPST-NC and SPST-NO with levers consult Omron.

2. Not all combinations are available. Consult Omron regarding nomenclature combinations and part numbers not found in this datasheet.

### Heat Resistant Models (Up to 150°C) - 15 A / 10A

Common terminal position	Contact form	Terminal style	Actuator	15 A	10 A
				200 gf	100 gf
Bottom	SPDT	Solder Terminals (A)	Pin plunger 	V-15-1A5-T	V-10-1A4-T
			Short hinge lever 	V-151-1A5-T	V-101-1A4-T
			Hinge lever 	V-152-1A5-T	V-102-1A4-T
			Long hinge lever 	V-153-1A5-T	V-103-1A4-T
			Simulated roller lever 	V-154-1A5-T	V-104-1A4-T
			Short hinge roller lever 	V-155-1A5-T	V-105-1A4-T
			Hinge roller lever 	V-156-1A5-T	V-106-1A4-T

Note: 1. Add "G" to the part number in the appropriate location to obtain a 0.5 mm contact gap. Add "-K" to the part number in the appropriate location to obtain 2.9 mm mounting holes. Add "C2" to the part number in the appropriate location to obtain versions with #187 quick-connect terminals. Example: 1) V-15G1-1C25-T-K

2. Not all combinations are available. Consult Omron regarding nomenclature combinations and part numbers not found in this datasheet.

# Specifications

## ■ Ratings (reference values)

Type	Rated voltage	Non-inductive load				Inductive load			
		Resistive load		Lamp load		Inductive load		Motor load	
		NC	NO	NC	NO	NC	NO	NC	NO
V-21	250 VAC	21 A		3 A		12 A		4 A	
	8 VDC	21 A		5 A		12 A		7 A	
	30 VDC	14 A		5 A		12 A		5 A	
	125 VDC	0.6 A		0.1 A		0.6 A		0.1 A	
	250 VDC	0.3 A		0.05 A		0.3 A		0.05 A	
V-16	250 VAC	16 A		2 A		10 A		3 A	
	8 VDC	16 A		4 A		10 A		6 A	
	30 VDC	10 A		4 A		10 A		4 A	
	125 VDC	0.6 A		0.1 A		0.6 A		0.1 A	
	250 VDC	0.3 A		0.05 A		0.3 A		0.05 A	
V-15	250 VAC	15 A		2 A		10 A		3 A	
	8 VDC	15 A		4 A		10 A		6 A	
	30 VDC	10 A		4 A		10 A		4 A	
	125 VDC	0.6 A		0.1 A		0.6 A		0.1 A	
	250 VDC	0.3 A		0.05 A		0.3 A		0.05 A	
V-11	250 VAC	11 A		1.5 A		6 A		2 A	
	8 VDC	11 A		3 A		6 A		3 A	
	30 VDC	6 A		3 A		6 A		3 A	
	125 VDC	0.6 A		0.1 A		0.6 A		0.1 A	
	250 VDC	0.3 A		0.05 A		0.3 A		0.05 A	
V-10	250 VAC	10 A		1.5 A		6 A		2 A	
	8 VDC	10 A		3 A		6 A		3 A	
	30 VDC	6 A		3 A		6 A		3 A	
	125 VDC	0.6 A		0.1 A		0.6 A		0.1 A	
	250 VDC	0.3 A		0.05 A		0.3 A		0.05 A	

- Note:**
- The above current values are the normal current values of models with a contact gap of 1 mm (gap F), which vary with the normal current values of models with a contact gap of 0.5 mm (gap G).
  - Inductive load has a power factor of 0.4 min. (AC) and a time constant of 7 ms max. (DC).
  - Lamp load has an inrush current of 10 times the steady-state current.
  - Motor load has an inrush current of 6 times the steady-state current.
  - The ratings values apply under the following test conditions: Ambient temperature: 20±2°C, Ambient humidity: 65±5%, Operating frequency: 30 operations/min

## ■ Approved Standards

UL1054 (File No. E41515)

CSA C22.2 No.55 (File No. LR21642)

Rated voltage	V-21	V-16	V-15	V-11	V-10
125 VAC	21 A, 1/2 HP	16 A, 1/2 HP	15 A, 1/2 HP	11 A, 1/3 HP	10 A, 1/3 HP
250 VAC					
125 VDC	0.6 A				
250 VDC	0.3 A				

EN 61058-1 (File No. 129608, VDE approval)

Rated voltage	V-21	V-16	V-11
250 VAC	20 (4) A	16 (4) A	11 (3) A

Testing conditions: 5E4 (50,000 operations), T105 (0°C to 105°C)

EN 61058-1 (File No. T9451451, TÜV Rheinland approval)

Rated voltage	V-15	V-10
250 VAC	15 A	10 A
250 VDC	0.3 A	

Testing conditions: 5E4 (50,000 operations), T85 (0°C to 85°C)

## ■ Characteristics

Operating speed	0.1 mm to 1 m/s (plunger models)
Operating frequency	Mechanical: 600 operations/minute, max. Electrical: 30 operations/minute, max.
Insulation resistance	100 MΩ min. (at 500 VDC)
Contact resistance	15 mΩ max.
Dielectric strength (see note 2)	1,000 VAC, 50/60 Hz for 1 min between terminals of the same polarity
	V-21, V-16 and V-11: 2,000 VAC, 50/60 Hz for 1 min between current-carrying metal parts and ground, and between each terminal and non-current-carrying metal parts
	V-15 and V-10: 1,500 VAC, 50/60 Hz for 1 min between current-carrying metal parts and ground, and between each terminal and non-current-carrying metal parts
Vibration resistance (see note 3)	Malfunction: 10 to 55 Hz, 1.5-mm double amplitude
Shock resistance (see note 3)	Destruction: 1,000 m/s <sup>2</sup> (approx. 100G) max.
	Malfunction: V-21/V-16/V-15: 300 m/s <sup>2</sup> (approx. 30G) max. V-11/V10: 200 m/s <sup>2</sup> (approx. 20G) max.
Life expectancy	Mechanical: 50,000,000 operations min. (60 operations/minute)
	Electrical: V-21/V-16/V-15: 100,000 operations min. (30 operations/minute) (V-15 heat resistive: 20,000 operations min. (30 ops/minute)) V-11/V-10: 300,000 operations min. (30 operations/minute) (V-10 heat resistive: 50,000 operations min. (30 ops/minute))
Degree of protection	IEC IP40
Degree of protection against electric shock	Class I
Proof tracking index (PTI)	175
Ambient operating temperature	-25°C to 80°C (at 60% RH max.) with no icing
	-25°C to 150°C for heat resistive models (at 60% RH max.) with no icing.
Ambient operating humidity	85% max. (for 5°C to 35°C)
Weight	Approx. 6.2 g (plunger models)

**Note:** 1. Data shown are of initial value.

2. The dielectric strength shown is measured using a separator between the switch and metal mounting plate.

3. For pin plunger models, the above values apply for use at both the free position and total travel position. For lever models, they apply at the total travel position.

4. For testing conditions, contact your OMRON sales representative.

## ■ Contact Specifications

Item		V-21	V-16	V-15	V-11	V-10
Contact	Specification	Rivet				
	Material	Silver alloy				Silver
	Gap (standard value)	1 mm (F gap type) or 0.5 mm (G gap type)				
Inrush current	NC	50 A max.	40 A max.	36 A max.	24 A max.	
	NO					
Minimum applicable load		160 mA at 5 VDC				

**Note:** Minimum applicable loads are indicated by N standard reference values. This value represents the failure rate at a 60% ( $\lambda_{60}$ ) reliability level (JIS C5003). The equation  $\lambda_{60}=0.5 \times 10^{-6}$  / operations indicates that a failure rate of 1/2,000,000 operations can be expected at a reliability level of 60%

# Engineering Data

## ■ Mechanical service life

(Pin plunger models)

V-21/-16/-15/-10



## ■ Electrical service life

(Pin plunger models)

V-21/-16/-15



V-11/-10



## ■ Contact Form

Common terminal position	Contact form		
	SPDT	SPST-NC*	SPST-NO*
Bottom type			
Side type			

\* The SPST-NC and SPST-NO contact form types listed in the ordering information tables are for Pin Plunger models only. For information concerning lever models consult Omron.

## ■ Barrier direction (V-21 and V-16)

Right-hand Barrier

Left-hand Barrier



## ■ Mounting Holes

All switches may be panel mounted using M3 mounting screws with plane washers or spring washers to securely mount the switch. Tighten the screws to a torque of 0.39 to 0.59 N·m.



# Dimensions

## ■ Terminals

- Note:** 1. Unless otherwise specified, all units are in millimeters and a tolerance of  $\pm 0.4$  mm applies to all dimensions  
 2. The following table is for the SPDT contact specifications. Two terminals will be available for SPST-NO or SPST-NC contact specifications. For terminal positions, refer to the above *Contact Form*  
 3. Right-angle PCB terminal type is available with some models (not shown). Drawings will be provided if requested.  
 D5: Pins at right angles, to the right  
 D6: Pins at right angle, to the left

Terminal type	Solder Terminal (A)	Quick-connect Terminal (#187) (C2)	Quick-connect Terminal (#250) (C)
COM bottom position	<p>t = 0.5 Three, solder terminals</p>	<p>t = 0.5 Three, quick-connect terminals (#187)</p>	<p>t = 0.8 Three, quick-connect terminals (#250)</p>
COM side position			
Terminal dimensions	<p>Note: Indicates the length to the center of the 1.6-dia. holes</p>	<p>1.6-dia. terminal hole</p>	<p>1.65-dia. terminal hole</p>



# ■ Dimensions and Operating Characteristics

## Thermoplastic Case Models

- Note:**
1. Unless otherwise specified, all units are in millimeters and a tolerance of  $\pm 0.4$  mm applies to all dimensions
  2. The following illustrations and drawings are for quick-connect terminals (#250) (terminals C). V models also incorporate terminals A and C2, which are omitted from the following drawings. Refer to *Terminals* section for the dimensions of these terminals.
  3. The □ in the model number is for the terminal code.
  4. The illustrations for V-21, V-16 and V-11 show a hole size of 3.1 mm. V-21, V-16 and V-11 models with a suffix "K" have a hole size of 2.9 mm.
  5. The operating characteristics are for operation in the A direction ( ↓ ).

## Pin Plunger Models

(Without Barrier)

- V-21-1□6
- V-16-1□5
- V-11-1□4



Characteristics	V-21-1□6	V-16-1□5
OF max.	400 gf	200 gf
RF min.	80 gf	50 gf
PT max.	1.2 mm	
OT min.	1.0 mm	
MD max.	0.4 mm	
OP	14.7 ± 0.4 mm	

(With Right-hand Barrier)

- V-21-1□R6
- V-16-1□R5



Characteristics	V-11-1□4	V-11-1□5
OF max.	100 gf	200 gf
RF min.	20 gf	50 gf
PT max.	1.2 mm	
OT min.	1.0 mm	
MD max.	0.4 mm	
OP	14.7 ± 0.4 mm	

(With Left-hand Barrier)

- V-21-1□L6
- V-16-1□L5



- Note:** 1. Unless otherwise specified, all units are in millimeters and a tolerance of  $\pm 0.4$  mm applies to all dimensions  
 2. The following illustrations and drawings are for quick-connect terminals (#250) (terminals C). V models also incorporate terminals A and C2, which are omitted from the following drawings. Refer to *Terminals* section for the dimensions of these terminals.  
 3. The □ in the model number is for the terminal code.  
 4. The illustrations for V-21, V-16 and V-11 show a hole size of 3.1 mm. V-21, V-16 and V-11 models with a suffix "K" have a hole size of 2.9 mm.  
 5. The operating characteristics are for operation in the A direction ( ↓ ).

### Short Hinge Lever Models

- V-211-1□6  
 V-161-1□5  
 V-111-1□4

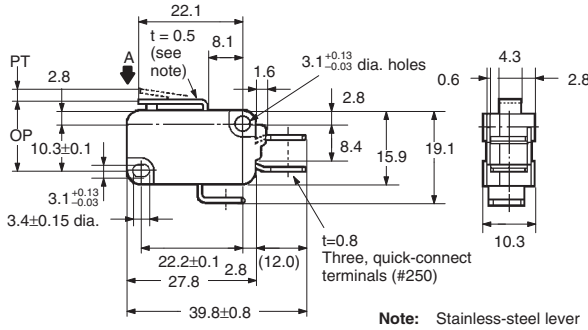

Characteristics	V-211-1□6	V-161-1□5	V-111-1□4
OF max.	400 gf	200 gf	100 gf
RF min.	50 gf	50 gf	15 gf
PT max.	1.6 mm		
OT min.	0.8 mm		
MD max.	0.6 mm		
OP	15.2 ± 0.5 mm		

### Hinge Lever Models

- V-212-1□6  
 V-162-1□5  
 V-112-1□4

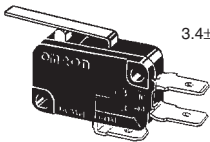

Characteristics	V-212-1□6	V-162-1□5	V-112-1□4
OF max.	250 gf	125 gf	60 gf
RF min.	25 gf	14 gf	6 gf
PT max.	4.0 mm		
OT min.	1.6 mm		
MD max.	1.5 mm		
OP	15.2 ± 1.2 mm		

### Long Hinge Lever Models

- V-213-1□6  
 V-163-1□5  
 V-113-1□4

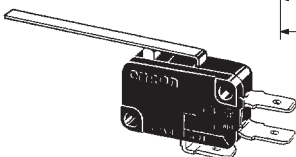

Characteristics	V-213-1□6	V-163-1□5	V-113-1□4
OF max.	130 gf	70 gf	35 gf
RF min.	12 gf	6 gf	---
PT max.	9.0 mm		
OT min.	2.0 mm		3.2 mm
MD max.	2.8 mm		
OP	15.2 <sup>+2.6</sup> / <sub>-3.2</sub> mm		15.2 ± 2.6 mm

- Note:** 1. Unless otherwise specified, all units are in millimeters and a tolerance of  $\pm 0.4$  mm applies to all dimensions  
 2. The following illustrations and drawings are for quick-connect terminals (#250) (terminals C). V models also incorporate terminals A and C2, which are omitted from the following drawings. Refer to *Terminals* section for the dimensions of these terminals.  
 3. The □ in the model number is for the terminal code.  
 4. The illustrations for V-21, V-16 and V-11 show a hole size of 3.1 mm. V-21, V-16 and V-11 models with a suffix "K" have a hole size of 2.9 mm.  
 5. The operating characteristics are for operation in the A direction ( ↓ ).

### Simulated Roller Lever Models

V-214-1□6  
 V-164-1□5  
 V-114-1□4



Characteristics	V-214-1□6	V-164-1□5	V-114-1□4
OF max.	250 gf	125 gf	60 gf
RF min.	25 gf	14 gf	6 gf
PT max.	4.0 mm		
OT min.	1.6 mm		
MD max.	1.5 mm		
OP	18.7 ± 1.2 mm		

### Short Hinge Roller Lever Models

V-215-1□6  
 V-165-1□5  
 V-115-1□4



Characteristics	V-215-1□6	V-165-1□5	V-115-1□4
OF max.	480 gf	240 gf	120 gf
RF min.	50 gf	50 gf	15 gf
PT max.	1.6 mm		
OT min.	0.8 mm		
MD max.	0.6 mm		
OP	20.7 ± 0.6 mm		

### Hinge Roller Lever Models

V-216-1□6  
 V-166-1□5  
 V-116-1□4



Characteristics	V-216-1□6	V-166-1□5	V-116-1□4
OF max.	250 gf	125 gf	60 gf
RF min.	25 gf	14 gf	6 gf
PT max.	4.0 mm		
OT min.	1.6 mm		
MD max.	1.5 mm		
OP	20.7 ± 1.2 mm		

## Thermosetting Case Models

- Note:** 1. Unless otherwise specified, all units are in millimeters and a tolerance of  $\pm 0.4$  mm applies to all dimensions  
 2. The following illustrations are for quick-connect terminals (#250) (terminals C). Refer to *Terminals* section for the dimensions of other terminals.  
 3. The □ in the model number is for the terminal code.  
 4. The illustrations show models with a suffix “K”, which have a hole size of 2.9 mm. Omit the “K” to obtain models with hole size = 3.1 mm.  
 5. The operating characteristics are for operation in the A direction ( ↓ ).

### Pin Plunger Models

V-15G-1□5-K  
 V-10G-1□5-K  
 V-10G-1□4-K



Characteristics	V-15G-1□5-K V-10G-1□5-K	V-10G-1□4-K
OF max.	200 gf	100 gf
RF min.	50 gf	20 gf
PT max.	1.2 mm	
OT min.	1.3 mm	
MD max.	0.3 mm	
OP	14.7 ± 0.4 mm	

### Short Hinge Lever Models

V-15G1-1□5-K  
 V-10G1-1□5-K  
 V-10G1-1□4-K



**Note:** Stainless-steel lever

Characteristics	V-15G1-1□5-K V-10G1-1□5-K	V-10G1-1□4-K
OF max.	200 gf	100 gf
RF min.	50 gf	15 gf
PT max.	1.5 mm	
OT min.	1.0 mm	
MD max.	0.5 mm	
OP	15.2 ± 0.5 mm	

### Hinge Lever Models

V-15G2-1□5-K  
 V-10G2-1□5-K  
 V-10G2-1□4-K



**Note:** Stainless-steel lever

Characteristics	V-15G2-1□5-K V-10G2-1□5-K	V-10G2-1□4-K
OF max.	125 gf	60 gf
RF min.	14 gf	6 gf
PT max.	3.3 mm	
OT min.	2.3 mm	
MD max.	0.8 mm	
OP	15.2 <sup>+2.6</sup> / <sub>-3.2</sub> mm	15.2 ± 1.2 mm

### Long Hinge Lever Models

V-15G3-1□5-K  
 V-10G3-1□5-K  
 V-10G3-1□4-K



**Note:** Stainless-steel lever

Characteristics	V-15G3-1□5-K V-10G3-1□5-K	V-10G3-1□4-K
OF max.	70 gf	35 gf
RF min.	6 gf	- - - gf
PT max.	9.0 mm	7.6 mm
OT min.	3.0 mm	3.2 mm
MD max.	2.0 mm	
OP	15.2 ± 2.6 mm	

- Note:** 1. Unless otherwise specified, all units are in millimeters and a tolerance of  $\pm 0.4$  mm applies to all dimensions  
 2. The following illustrations are for quick-connect terminals (#250) (terminals C). Refer to *Terminals* section for the dimensions of other terminals.  
 3. The □ in the model number is for the terminal code.  
 4. The illustrations show models with a suffix “K”, which have a hole size of 2.9 mm. Omit the “K” to obtain models with hole size = 3.1 mm.  
 5. The operating characteristics are for operation in the A direction ( ↓ ).

### Simulated Roller Lever Models

V-15G4-1□5-K  
 V-10G4-1□5-K  
 V-10G4-1□4-K



Characteristics	V-15G4-1□5-K V-10G4-1□5-K	V-10G4-1□4-K
OF max.	125 gf	60 gf
RF min.	14 gf	6 gf
PT max.	3.3 mm	
OT min.	2.3 mm	
MD max.	0.8 mm	
OP	18.7 ± 1.2 mm	

### Short Hinge Roller Lever Models

V-15G5-1□5-K  
 V-10G5-1□5-K  
 V-10G5-1□4-K



Characteristics	V-15G5-1□5-K V-10G5-1□5-K	V-10G5-1□4-K
OF max.	240 gf	120 gf
RF min.	50 gf	15 gf
PT max.	1.5 mm	
OT min.	1.0 mm	
MD max.	0.5 mm	
OP	20.7 ± 0.6 mm	

### Hinge Roller Lever Models

V-15G6-1□5-K  
 V-10G6-1□5-K  
 V-10G6-1□4-K



Characteristics	V-15G6-1□5-K V-10G6-1□5-K	V-10G6-1□4-K
OF max.	125 gf	60 gf
RF min.	14 gf	6 gf
PT max.	3.3 mm	
OT min.	2.3 mm	
MD max.	0.8 mm	
OP	20.7 ± 1.6 mm	

## Accessories

Refer to the “V/VX/D3C Common Accessories” datasheet for information regarding VAL, VAM and VAV external actuators (sold separately).

# Precautions

Be sure to read the precautions and information common to all Snap Action and Detection Switches, contained in the Technical User's Guide, "Snap Action Switches, Technical Information" for correct use.

## ■ Correct Use

### Terminal Connection

To solder the lead to the solder terminal, apply a soldering iron rated at 60 W max. quickly (within 5 seconds) with the actuator at the free position.

Note that applying a soldering iron for too long a time or using one that is rated at more than 60 W may degrade the switch characteristics.

Use an appropriate mating connector for #187 or #250 quick connect terminals.

### Specifications Approved by TÜV Rheinland According to EN61058-1

#### Appropriate Cable Size (mm<sup>2</sup>)

Model	Solder terminal
V-10	0.75, 1.25, 2.0
V-15	1.25, 2.0

## Operation

Make sure that the operating body pushes the switch actuator with an adequate force when the switch is to be operated, and that it does not touch the actuator when the switch is released.

Do not change the operating position by modifying the actuator.

Do not use the switch in a application where the operating speed is extremely slow or the actuator is set in the midpoint between the free position and operating position.

Install the pin plunger switch so that the operating force is applied in alignment with the stroke of the actuator. The switch should be set so that its stroke is in the range of 60 to 90% of the rated OT (minimum value) when the switch has been operated.

## ■ Cautions

### Insulation Distance

According to EN61058-1, the minimum insulation thickness for this switch should be 1.1 mm and minimum clearance distance between the terminal and mounting plate should be 1.0 mm. If the insulation distance cannot be provided in the product incorporating the switch, either use a switch with insulation barrier or use a separator to ensure sufficient insulation distance.



All sales are subject to Omron Electronic Components LLC standard terms and conditions of sale, which can be found at [http://www.components.omron.com/components/web/webfiles.nsf/sales\\_terms.html](http://www.components.omron.com/components/web/webfiles.nsf/sales_terms.html)

**ALL DIMENSIONS SHOWN ARE IN MILLIMETERS.**  
To convert millimeters into inches, multiply by 0.03937. To convert grams into ounces, multiply by 0.03527.

---

**OMRON**<sup>®</sup>

**OMRON ELECTRONIC  
COMPONENTS LLC**

55 E. Commerce Drive, Suite B  
Schaumburg, IL 60173

**847-882-2288**

**OMRON ON-LINE**

Global - <http://www.omron.com>

USA - <http://www.components.omron.com>



Компания «Океан Электроники» предлагает заключение долгосрочных отношений при поставках импортных электронных компонентов на взаимовыгодных условиях!

Наши преимущества:

- Поставка оригинальных импортных электронных компонентов напрямую с производств Америки, Европы и Азии, а так же с крупнейших складов мира;
- Широкая линейка поставок активных и пассивных импортных электронных компонентов (более 30 млн. наименований);
- Поставка сложных, дефицитных, либо снятых с производства позиций;
- Оперативные сроки поставки под заказ (от 5 рабочих дней);
- Экспресс доставка в любую точку России;
- Помощь Конструкторского Отдела и консультации квалифицированных инженеров;
- Техническая поддержка проекта, помощь в подборе аналогов, поставка прототипов;
- Поставка электронных компонентов под контролем ВП;
- Система менеджмента качества сертифицирована по Международному стандарту ISO 9001;
- При необходимости вся продукция военного и аэрокосмического назначения проходит испытания и сертификацию в лаборатории (по согласованию с заказчиком);
- Поставка специализированных компонентов военного и аэрокосмического уровня качества (Xilinx, Altera, Analog Devices, Intersil, Interpoint, Microsemi, Actel, Aeroflex, Peregrine, VPT, Syfer, Eurofarad, Texas Instruments, MS Kennedy, Miteq, Cobham, E2V, MA-COM, Hittite, Mini-Circuits, General Dynamics и др.);

Компания «Океан Электроники» является официальным дистрибьютором и эксклюзивным представителем в России одного из крупнейших производителей разъемов военного и аэрокосмического назначения «JONHON», а так же официальным дистрибьютором и эксклюзивным представителем в России производителя высокотехнологичных и надежных решений для передачи СВЧ сигналов «FORSTAR».



## JONHON

«JONHON» (основан в 1970 г.)

Разъемы специального, военного и аэрокосмического назначения:

(Применяются в военной, авиационной, аэрокосмической, морской, железнодорожной, горно- и нефтедобывающей отраслях промышленности)

«FORSTAR» (основан в 1998 г.)

ВЧ соединители, коаксиальные кабели,  
кабельные сборки и микроволновые компоненты:

(Применяются в телекоммуникациях гражданского и специального назначения, в средствах связи, РЛС, а так же военной, авиационной и аэрокосмической отраслях промышленности).



Телефон: 8 (812) 309-75-97 (многоканальный)

Факс: 8 (812) 320-03-32

Электронная почта: [ocean@oceanchips.ru](mailto:ocean@oceanchips.ru)

Web: <http://oceanchips.ru/>

Адрес: 198099, г. Санкт-Петербург, ул. Калинина, д. 2, корп. 4, лит. А