

**LADD**  
DISTRIBUTION  
a TE Connectivity Company





LADD specializes in the sales, marketing, distribution, and technical support of select TE Connectivity Industrial & Commercial Transportation electrical connectors and accessories. LADD is more than just a distributor. We haven't forgotten the importance of personal service. The Customer Service department can assist you with technical answers, pricing, orders, and more.

## TE Connectivity Industrial & Commercial Transportation Distribution

### LADD Distribution

**CANADA & UNITED STATES:**  
**LADD Distribution LLC**  
Tel: +1-800-223-1236  
Fax: +1-937-438-9755  
ladd.us@te.com  
ladd.canada@te.com

**CHINA:**  
**LADD Distribution**  
Deutsch Connectors Trading (Shanghai) Co., Ltd.  
Tel: +8621-33981423  
ladd.china@te.com

**EUROPE, MIDDLE EAST, & AFRICA:**  
**LADD Distribution**  
Tyco Electronics AMP GmbH  
Tel: +49-89-899157-0  
Fax: +49-89-8574684  
ladd.emea@te.com

**JAPAN:**  
**LADD Distribution Ltd.**  
Tel: +81-3-5922-1345  
ladd.japan@te.com

### Other TE Connectivity Locations

**ARGENTINA:**  
Tyco Electronics Argentina S.A.  
Tel: +5411-4733-2200  
Fax: +5411-4733-2213

**AUSTRALIA:**  
Tyco Electronics Pty Limited  
Tel: +1300-509-970  
DeutschANZ@te.com

**BRAZIL:**  
Tyco Electronics Brasil Ltda.  
Tel: +55-11-3404-6000  
Fax: +55-11-3404-6091

**INDIA:**  
Deutsch India Power Connectors Ltd.  
Tel: +91-120-6794425  
Fax: +91-120-6794413

**ISRAEL:**  
Deutsch Israel Ltd.  
Tel: +972-8-671-9020

**KOREA:**  
Tyco Electronics AMP Korea Limited  
Tel: +82-2-3415-4583  
Fax: +82-2-3486-3595

**SOUTH AFRICA:**  
Tyco Electronics South Africa (Proprietary) Ltd.  
Tel: +2711-707-6300  
Fax: +2711-466-3555

**UNITED KINGDOM:**  
Deutsch UK  
Tel: +01424-857148  
Fax: +01424-855979

# Table of Contents

## General Information

About TE Connectivity	2
Connector Series Overview	8
Introduction to Connectors	3
Technical Specifications	5

## Products

AEC Series	13
AMPSEAL Connectors	17
AMPSEAL16 Connectors	23
Contacts	115
DRB Series	29
DRC Series	37
DT Family	43
HD10 Series	61
HD30 & HDP20 Series	69

STRIKE Series	81
Tooling	129

## Specialty Products

Bussing Options	85
Controller Area Networks	91
Diodes & Resistors	97
Printed Circuit Board Connectors	101
Single Terminal	111

## Additional Resources

Modification List	142
Standards	149
Glossary	150
Index	157

## About TE Connectivity



TE Connectivity's Industrial & Commercial Transportation business unit – every connection counts

TE Connectivity's products are in nearly every high-tech product imaginable. From consumer electronics, health care, energy supply, and communication networks, to the automotive and aviation industries, TE's extensive portfolio of over 500,000 products keep the world connected. TE Connectivity's intelligent and robust solutions and technologies carry over to the industrial and heavy duty vehicle markets. TE Connectivity offers products that work just as hard as the vehicles in which they are installed.

Years ago, tractors, construction equipment, trucks, and boats had simple electrical systems that might have included electrical starting and a basic lighting package. Today, ECUs, joysticks, fuel-efficient engines, LED lights, and CAN systems are standard equipment. The need to protect sensitive electrical systems from vibration, moisture, dust, dirt, salt and airborne particles has never been greater. To support today's increasingly complex and sophisticated equipment and applications, TE Connectivity's Industrial & Commercial Transportation business unit was created.

TE Connectivity's Industrial & Commercial Transportation business unit was formed in 2012, when TE acquired the Deutsch group of companies. For decades, DEUTSCH industrial electrical connectors have been counted on by industry leading manufacturers to maintain electrical connections and to keep equipment running. TE Connectivity has been among the world leaders in interconnector solutions for OEMs for over 50 years. Now together, establishing an unparalleled product portfolio with global presence, TE Connectivity's Industrial & Commercial Transportation business unit provides cutting-edge solutions to face the complex challenges of today's marketplace.

From heavy duty trucks to construction equipment, mining vehicles to fire trucks, as well as boats, motorcycles, and tractors, leading manufacturers count on TE Connectivity's Industrial & Commercial Transportation business unit.



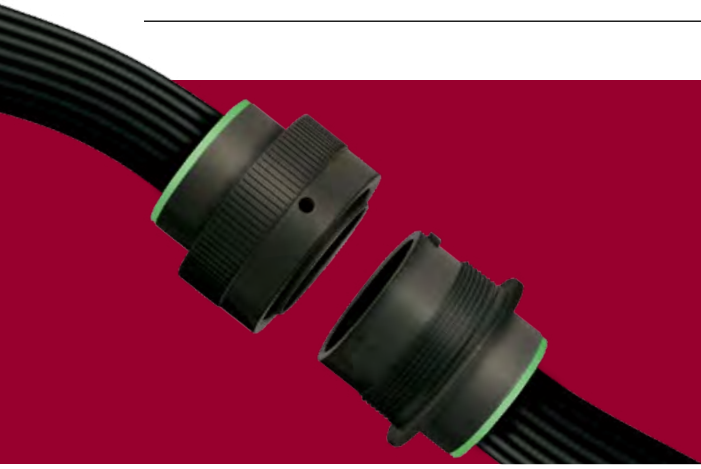

# Introduction to Connectors

In heavy industries, electrical systems must stand up to rigorous conditions and all weather environments. Failure in an electrical system can be expensive to diagnose and down equipment can stop entire operations. As equipment becomes increasingly sophisticated and reliant on electronic packaging and diagnostics, design engineers know the importance of choosing environmentally sealed electrical connectors capable of holding up to extreme conditions. Many manufacturers count on TE Connectivity's Industrial & Commercial Transportation electrical connectors to maintain their electrical connections.



### Benefits of industrial connectors

There are many different connectors for harsh environments and connector selection for each specific application is important. Once the questions of wire gauge and pin count have been addressed, the environmental challenges specific to each application must be identified, including if the electrical system will be exposed to heat, impact or vibration. Other elements that need to be addressed include if the connectors will be susceptible to moisture or chemicals and field serviceability. Developed with simplicity of design and ease of use in mind, TE Connectivity connectors offer a variety of innovative solutions to suit nearly any application and stand up to environmental challenges.

Whether for a new application or a retrofit, connectors provide simplified design and wiring, and easy field repairs. Industrial & Commercial Transportation connector applications include ECUs, joysticks, industrial and marine engines, control boxes, lights and CAN systems, just to mention a few. TE Industrial & Commercial Transportation's connector series offer several features designed to combat environmental challenges.

### Connector features help protect electrical connections

Connector bodies must be able to stand up to the environmental conditions. Rugged all-metal bodies and corrosion resistant thermoplastic shells are manufactured from high quality materials selected for their ability to withstand years of environmental exposure. Metal connectors are built to withstand the force and shock of hard impacts that connectors face in rough environments. High-grade thermoplastic connectors are lightweight and are engineered to be flame resistant and extremely chemical resistant. Different connector body materials are available

# Introduction to Connectors

---

to meet diverse application requirements.

Proper contact alignment is another important aspect of environmentally sealed electrical connectors. Secondary locks snap into or onto the mating face of a connector to help make sure that the contacts slide together properly when the connectors are mated. Many of TE Connectivity's Industrial & Commercial Transportation connectors feature secondary locks that are commonly referred to as wedgelocks or terminal position assurance (TPA). Wedgelocks and TPAs provide additional stability to both the contact barrel and the mated connectors.

A firm, secure locking mechanism that can withstand vibration and shock is critical to maintain a steadfast connector engagement in rugged applications. TE Connectivity's Industrial & Commercial Transportation connectors are held together by push-latches, threaded coupling rings, or tightened together by jackscrews. The locking mechanisms are easy to engage and disengage and give an audible or tactile signal when they are securely fastened. Once fastened, the locking mechanisms prevent disengagement due to vibration or impact.

Since even a small degradation in electrical connections can be critical to industrial vehicles, manufacturers are turning to TE Connectivity's Industrial & Commercial Transportation's environmentally sealed electrical connectors to keep their equipment running. Connectors are increasingly needed as industrial equipment becomes more complex and reliant on electronic control units, CAN systems, and on-board communications systems. With a wide variety of industrial electrical connectors, manufacturers can find a connector for nearly any application. No matter the environment, TE Connectivity's industrial connectors provide the innovative solutions demanded by harsh conditions. TE Connectivity's dedication to quality and innovation has created a unique system of easy-to-use connectors to simplify processes from start to finish.



## Technical Specifications

### ■ AMPSEAL Connector Performance Specifications

#### Current

Up to 17 amps gold, up to 8 amps tin

#### Temperature

Operating at temperatures  $-40^{\circ}\text{C}$  to  $+125^{\circ}\text{C}$  for gold plated,  $-40^{\circ}\text{C}$  to  $+105^{\circ}\text{C}$  for tin plated.

#### Durability

See *note*. Mate and unmate specimens for 10 cycles at maximum rate of 600 cycles per hour.

#### Physical Shock

No discontinuities of 1 microsecond or longer duration. TE Spec 109-26-1. Subject mated specimens to 50 G's half-sine shock pulses of 11 milliseconds duration. Three shocks in each direction applied along 3 mutually perpendicular planes, 18 total shocks. See Fig 5 in TE product document 108-1329.

#### Insulation Resistance

100 megohms minimum. TE Spec 109-28-4. Test between adjacent contacts of mated specimens.

#### Immersion

Leakage current not to exceed 50 micro-amperes at 48 volts DC. TE Spec 109-74-5. Immerse specimens to a depth of 100 mm in 5% salt water at a temperature of  $23 \pm 5^{\circ}\text{C}$  for 1 hour. Check between adjacent circuits and each surface to reference electrode.

#### Random Vibration

See *note*. TE Spec 109-21-7, Condition G, except 10-500 Hz frequency range. Subject mated specimens to 10 Gs for 8 hours each plane.

#### Voltage

250 volts AC

Note: Shall meet visual requirements, show no physical damage and shall meet requirements of additional tests as specified in Test Sequence in Figure 3 of TE product document 108-1329.

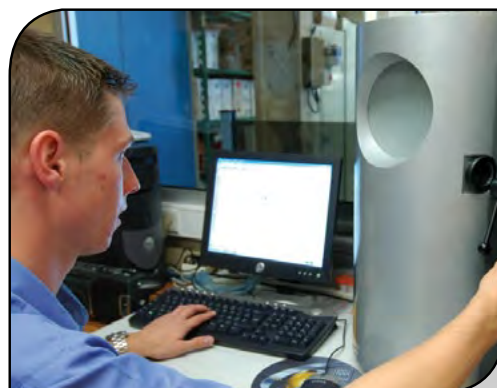

# Technical Specifications

---

## ■ AMPSEAL 16 Connector Performance Specifications

---

### Current

Up to 13 amps

### Temperature

Operating at temperatures -40° C to +125° C.

### Durability

See *note*. 50 cycles.

### Insulation Resistance

20 megohms minimum. SAE J2030 6.3. Insulation resistance at 1000 volts DC adjacent terminals measured after 60 seconds or until stabilization occurs.

### Immersion

IP67 rating

### Random Vibration

No discontinuities. See *note*. EIA-364-28 Subject mated specimens to 21 G's rms between 25 to 2000 Hz. Twenty hours in each of three mutually perpendicular planes.

### Voltage

250 volts DC

Note: Shall meet visual requirements, show no physical damage, and meet requirements of additional tests as specified in the Product Qualification and Requalification Test Sequence in Figure 3 of TE product document 108-2184.

## ■ DEUTSCH Connector Performance Specifications

---

### Temperature

Operating at temperatures from -55° C to +125° C continuous at rated current.

- DTMH Series: -55° C to +150° C

### Durability

No electrical or mechanical defects after 100 cycles of engagement and disengagement.

### Vibration

No unlocking or unmating and exhibits no mechanical or physical damage after sinusoidal vibration levels of 20 G's at 10 to 2000 Hz in each of the three mutually perpendicular planes. No electrical discontinuities longer than 1 microsecond.

### Physical Shock

No unlocking, unmating, or other unsatisfactory result during or after 50 G's in each of three mutually perpendicular planes. No electrical discontinuities longer than 1 microsecond. MIL-STD 202, Method 213, Condition "C".

### Fluid Resistance

Connectors show no damage when exposed to most fluids used in industrial applications.

### Insulation Resistance

1000 megohms minimum at 25° C.

### Moisture Resistance

Properly wired and mated connections will withstand immersion under three feet of water without loss of electronic qualities or leakage.

- Moisture resistance does not apply to DTMN Series

### Dielectric Withstanding Voltage

Current leakage less than 2 milliamps at 1500 VAC.

### Thermal Cycle

No cracking, chipping or leaking after 20 test cycles from -55° C to +125° C.

### Notice

Please consult drawings for full specifications.



## ■ Connector Material Specifications

### AEC Series

Grommet: Silicone rubber  
Jackscrew: Steel  
Plug Threaded Inserts: Steel  
Shell: Thermoplastic

### AMPSEAL

Wire Seal: Silicone rubber  
Mating Seal: Silicone rubber  
Cover: Glass filled PBT  
Locking Wedge: PBT

### AMPSEAL 16

Wire Seal: Silicone rubber  
Plug Peripheral Seal: Silicone rubber  
Housing: 15% Glass filled thermoplastic  
CPA: 15% Glass filled thermoplastic  
PLR: 15% Glass filled thermoplastic

### DRB Series

Flange Body: Thermoplastic  
Flange Clip: Steel  
Grommet: Silicone rubber  
Jackscrew: Steel  
Receptacle Threaded Inserts: Steel  
Shell: Thermoplastic  
Wedgelocks: Thermoplastic

### DRC Series

Grommet: Silicone rubber  
Insert Retainer: Thermoplastic  
Jackscrew: Steel  
Receptacle Threaded Inserts: Steel/Brass  
Shell: Thermoplastic

### DT Family (DT, DTM, DTMH, DTP, DTV)

Grommet: Silicone rubber  
Insert Retainer: Thermoplastic  
Receptacle Interfacial Seal: Silicone rubber  
Shell: Thermoplastic  
Wedgelocks: Thermoplastic

### DTHD Series

Grommet: Silicone rubber  
Shell: Thermoplastic

### HD10 Series

Grommet: Silicone rubber  
Insert Retainer: Thermoplastic  
Receptacle Interfacial Seal: Silicone rubber  
Shell: Thermoplastic

### HDP20 Series

Grommet: Silicone rubber  
Insert Retainer: Thermoplastic  
Plug Coupling Ring: Thermoplastic  
Shell: Thermoplastic

### HD30 Series

Grommet: Silicone rubber  
Insert Retainer: Thermoplastic  
Plug Coupling Ring: Aluminum  
Shell: Aluminum

### STRIKE Series

Flange Seal: Silicone rubber  
Plug Grommet: Silicone rubber  
Receptacle Threaded Inserts: Brass  
Shell: Thermoplastic  
TPA: Thermoplastic



## Connector Series Overview

Each connector series offers different design features to accommodate many design requirements. Below is an overview of each series that highlights the cavity count, wire gauge, material, and locking mechanism style. For complete series information, please see the series section of the catalog. TE Connectivity connectors offer different shapes, latching mechanisms, mounting styles, and materials to meet diverse application requirements and all DEUTSCH product lines offer accessories to further expand the series flexibility.

### ■ AEC Series

Key Features:

- Accepts contact size 16 (13 amps)
- 14-20 AWG
- 40 cavity arrangement
- In-line or PCB mount
- Square, thermoplastic housing
- Jackscrew for mating



### ■ AMPSEAL Connectors

Key Features:

- Accepts contact size 1.3 mm (up to 17 amps gold, up to 8 amps tin)
- 16-20 AWG
- 8, 14, 23, and 35 cavity arrangements
- PCB mount
- Rectangular, thermoplastic housing
- Integrated latch for mating
- Integrated wedgelock confirms contact alignment and retention
- Product specification documents: 108-1329 and 114-16016



### ■ AMPSEAL 16 Connectors

Key Features:

- Accepts contact size 16 (up to 13 amps)
- 14-20 AWG
- 2, 3, 4, 6, 8, and 12 cavity arrangements
- In-line mount
- Rectangular, thermoplastic housing
- Integrated latch for mating
- Integrated PLR confirms contact alignment and retention
- Product specification documents: 108-2184, 114-13045, and 114-13065



## ■ DRB Series

### Key Features:

- Accepts contact sizes 4 (100 amps), 8 (60 amps), 12 (25 amps), 16 (13 amps), and 20 (7.5 amps)
- 6-22 AWG
- 48, 60, 102, and 128 cavity arrangements
- Flange mount
- Rectangular, thermoplastic housing
- Jackscrew for mating
- Wedgelocks confirm contact alignment and retention



## ■ DRC Series

### Key Features:

- Accepts contact sizes 16 (13 amps) and 20 (7.5 amps)
- 14-22 AWG
- 24, 38, 40, 50, 60, 64, 70, and 76 cavity arrangements
- In-line, flange, or PCB mount
- Rectangular, thermoplastic housing
- Jackscrew for mating



## ■ DT Series

### Key Features:

- Accepts contact size 16 (13 amps)
- 14-20 AWG
- 2, 3, 4, 6, 8, and 12 cavity arrangements
- In-line, flange, or PCB mount
- Rectangular, thermoplastic housing
- Integrated latch for mating
- Wedgelocks confirm contact alignment and retention



## ■ DTHD Series

### Key Features:

- Accepts contact sizes 4 (100 amps), 8 (60 amps), and 12 (25 amps)
- 6-14 AWG
- 1 cavity arrangement
- In-line or flange mount
- Circular, thermoplastic housing
- Integrated latch for mating



# Connector Series Overview

---

## ■ DTM Series

---

### Key Features:

- Accepts contact size 20 (7.5 amps)
- 16-22 AWG
- 2, 3, 4, 6, 8, and 12 cavity arrangements
- In-line, flange, or PCB mount
- Rectangular, thermoplastic housing
- Integrated latch for mating
- Wedgelocks confirm contact alignment and retention

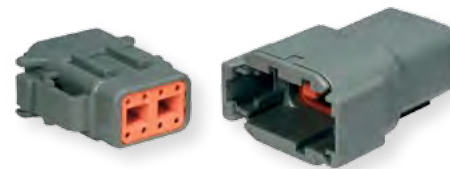

## ■ DTP Series

---

### Key Features:

- Accepts contact size 12 (25 amps)
- 10-14 AWG
- 2 and 4 cavity arrangements
- In-line, flange, or PCB mount
- Rectangular, thermoplastic housing
- Integrated latch for mating
- Wedgelocks confirm contact alignment and retention



## ■ DTV Series

---

### Key Features:

- Accepts contact size 16 (13 amps)
- 14-20 AWG
- 18 cavity arrangement
- Flange mount
- Rectangular, thermoplastic housing
- Integrated latch for mating
- Wedgelocks confirm contact alignment and retention



## ■ HD10 Series

---

### Key Features:

- Accepts contact sizes 4 (100 amps), 12 (25 amps), and 16 (13 amps)
- 6-20 AWG
- 3, 4, 5, 6, and 9 cavity arrangements
- In-line, flange, or PCB mount
- Circular, thermoplastic housing
- Coupling ring for mating



## ■ HD30 Series

### Key Features:

- Accepts contact sizes 4 (100 amps), 8 (60 amps), 12 (25 amps), 16 (13 amps), and 20 (7.5 amps)
- 6-22 AWG
- 2, 6, 7, 8, 9, 14, 16, 18, 19, 20, 21, 23, 29, 31, 33, 35, and 47 cavity arrangements
- In-line or flange mount
- Circular, aluminum housing
- Coupling ring for mating



## ■ HDP20 Series

### Key Features:

- Accepts contact sizes 4 (100 amps), 8 (60 amps), 12 (25 amps), 16 (13 amps), and 20 (7.5 amps)
- 4-22 AWG
- 2, 6, 7, 8, 9, 14, 16, 18, 19, 20, 21, 23, 29, 31, 33, 35, and 47 cavity arrangements
- In-line or flange mount
- Circular, thermoplastic housing
- Coupling ring for mating



## ■ STRIKE Series

### Key Features:

- Accepts contact sizes 16 (13 amps) and 20 (7.5 amps)
- 14-22 AWG
- 32 and 64 cavity arrangements
- In-line, flange, or PCB mount
- Square, thermoplastic housing
- Lever for mating
- TPA confirms contact alignment and retention





# AEC Series



## Contents

AEC Series Overview	14
Part Numbering System	14
Dimensions	14
Configuration	15
Accessories	15

## AEC Series Overview

The DEUTSCH AEC Series connectors are environmentally sealed, heavy duty electrical connectors that accept size 16 contacts. The AEC Series connectors are constructed of rugged thermoplastic and offer receptacles with either in-line or PCB mounting options.



### Part Numbering System

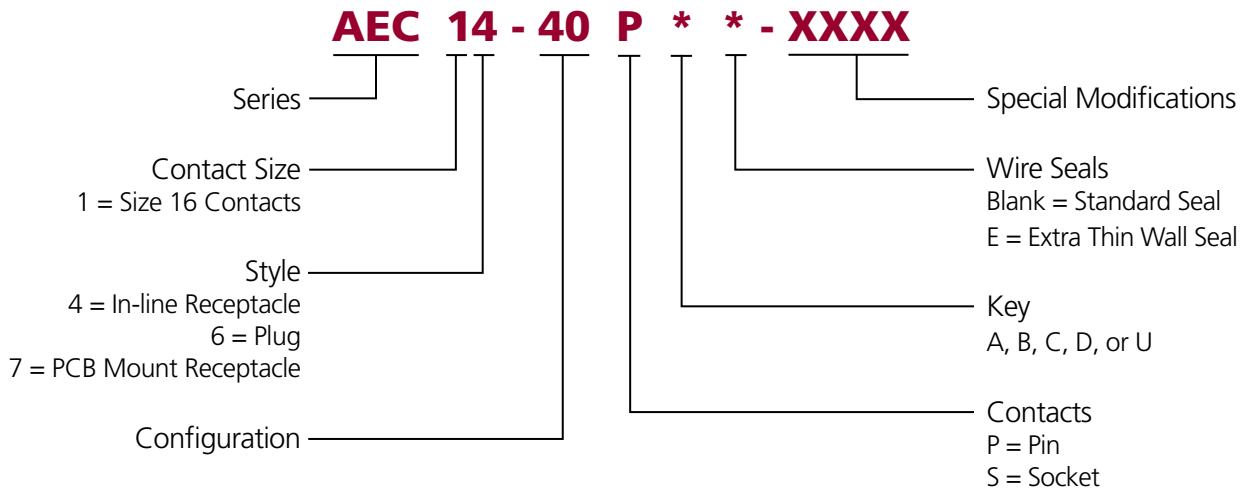

### Dimensions

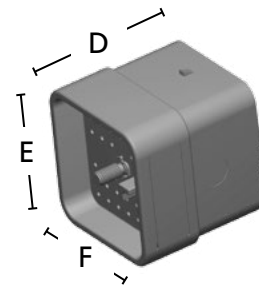
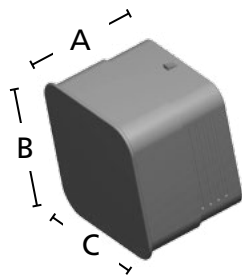

Cavity	AEC Plug			AEC Receptacle		
	Overall Length A	Overall Height B	Overall Width C	Overall Length D	Overall Height E	Overall Width F
40	1.440 (36.58)	1.778 (45.16)	1.894 (48.11)	1.642 (41.71)	1.944 (49.38)	1.828 (46.43)

Dimensions are for reference only.



## ■ Configuration

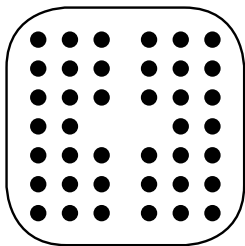
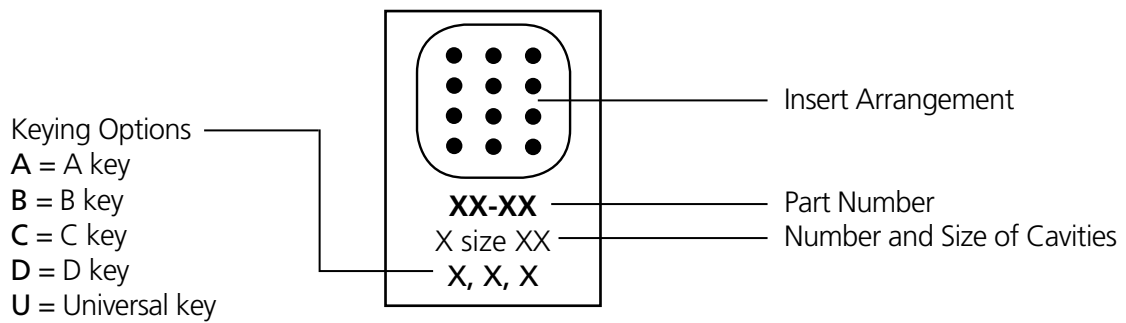

**AEC1\*-40\*\*\***  
 40 size 16  
 A, B, C, D, U

Notice

Do not over torque  
 jackscrew. The recommended  
 torque rating for the AEC  
 Series plug jackscrew when  
 tightening is 25-28 IN-LB  
 (2.86-3.16 N.M.).

## Accessories

Dust caps and boots are available for use with the AEC Series. The dust caps are designed to provide protection to the connector interface when the connector halves are not mated. The boots are aesthetically appealing and provide increased protection from dirt, paint overspray, and pressure washing.



### Dust Cap

Part Number	Description
0504-002-4001	Dust cap, 40 way receptacle, environmentally sealed
0515-009-4005	Dust cap, 40 way receptacle, non-environmentally sealed
0515-010-4005	Dust cap, 40 way plug, non-environmentally sealed



### Boot

Part Number	Description
AEC40-BT-STPDWN	Boot, 40 way plug or receptacle, black, step-down

\*Distorting the boots can lessen their longevity



# AMPSEAL Connectors

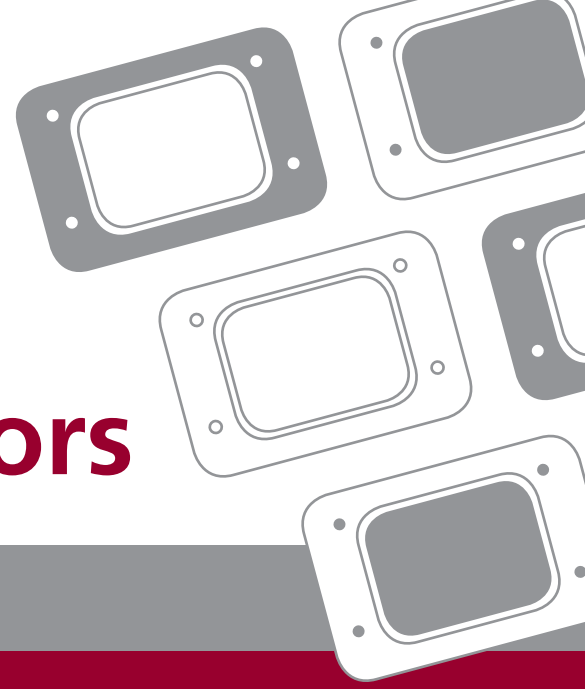

## Contents

AMPSEAL Connector Overview	18
Product Documentation	18
Dimensions	18
Configurations	19
Part Numbers	19
Accessories	20
How To Instructions	20-21

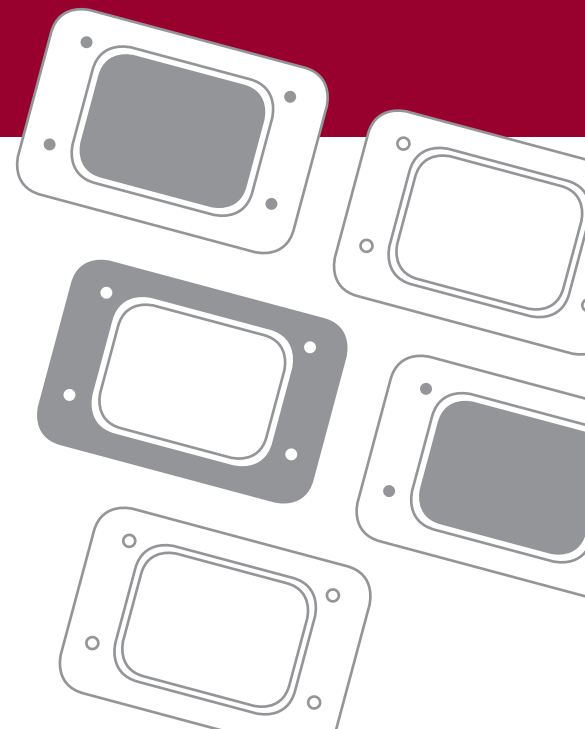

# AMPSEAL Connectors

## AMPSEAL Connector Overview

AMPSEAL connectors provide rugged reliability and environmental sealing. They are available in cable plugs and PCB mount headers that are designed to stand up to high-temperature underhood applications.

The pre-assembled receptacle housing connector features built-in contact sealing and an integral interfacial seal that protects mated connectors.



### ■ Applicable Product Documentation

Additional documentation is available for assistance with AMPSEAL products. The following TE Connectivity document numbers may be helpful:

1654285-2 (Catalog Section)  
 108-1329 (Product Specification)  
 114-16016 (Application Specification)

408-3229 (Instruction Sheet)  
 408-9592 (Instruction Sheet, Tooling)  
 408-9999 (Instruction Sheet, Tooling)

### ■ Dimensions

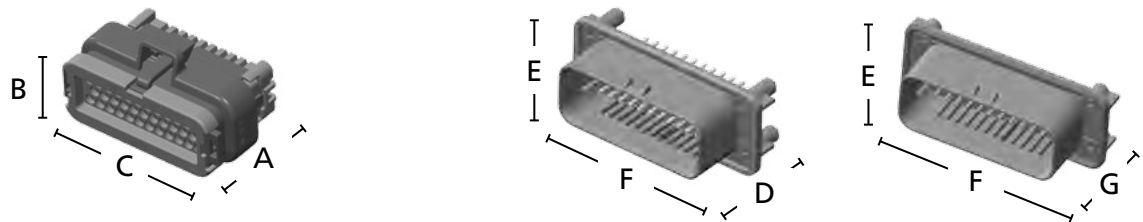

Cavity	AMPSEAL Plug			AMPSEAL Header			
	Overall Length A	Overall Height B	Overall Width C	Overall Length Straight D	Overall Height E	Overall Width F	Overall Length 90° G
8	1.32 (33.6)	1.36 (34.6)	1.08 (27.4)	1.35 (34.3)	1.26 (32.1)	1.61 (40.8)	1.49 (37.9)
14	1.32 (33.6)	1.36 (34.6)	1.39 (35.4)	1.35 (34.3)	1.26 (32.1)	1.92 (48.8)	1.49 (37.9)
23	1.32 (33.6)	1.36 (34.6)	1.87 (47.4)	1.35 (34.25)	1.26 (32.1)	2.39 (60.8)	1.49 (37.9)
35	1.32 (33.6)	1.36 (34.6)	2.50 (63.4)	1.35 (34.25)	1.26 (32.1)	3.03 (76.9)	1.49 (37.9)

Dimensions are for reference only.

## ■ Configurations

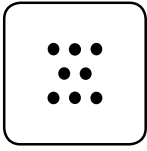

**8 Positions**  
8 size 1.3 mm

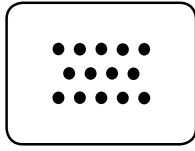

**14 Positions**  
14 size 1.3 mm

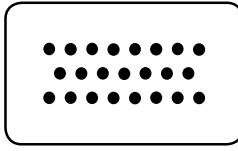

**23 Positions**  
23 size 1.3 mm

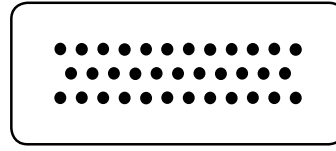

**35 Positions**  
35 size 1.3 mm

## ■ Part Numbers

Position	Keyed Housing Color	Contact Finish	Receptacle Housing (Plug)	Right-Angle PCB Header		Vertical PCB Header	
				Without Seal	With Seal	Without Seal	With Seal
8	Black	Tin plated	776286-1	776279-1	776280-1	776275-1	776276-1
		Gold plated		1-776279-1	1-776280-1	1-776275-1	1-776276-1
	Natural	Tin plated	776286-2	776279-2	776280-2	776275-2	776276-2
		Gold plated		1-776279-2	1-776280-2	1-776275-2	1-776276-2
14	Black	Tin plated	776273-1	776266-1	776267-1	776261-1	776262-1
		Gold plated		1-776266-1	1-776267-1	1-776261-1	1-776262-1
	Natural	Tin plated	776273-2	776266-2	776267-2	776261-2	776262-2
		Gold plated		1-776266-2	1-776267-2	1-776261-2	1-776262-2
	Gray	Tin plated	776273-4	776266-4	776267-4	776261-4	776262-4
		Gold plated		1-776266-4	1-776267-4	1-776261-4	1-776262-4
	Blue	Tin plated	776273-5	776266-5	776267-5	776261-5	776262-5
		Gold plated		1-776266-5	1-776267-5	1-776261-5	1-776262-5
23	Black	Tin plated	770680-1	770669-1	776087-1	776200-1	776228-1
		Gold plated		1-770669-1	1-776087-1	1-776200-1	1-776228-1
	Natural	Tin plated	770680-2	770669-2	776087-2	776200-2	776228-2
		Gold plated		1-770669-2	1-776087-2	1-776200-2	1-776228-2
	Gray	Tin plated	770680-4	770669-4	776087-4	776200-4	776228-4
		Gold plated		1-770669-4	1-776087-4	1-776200-4	1-776228-4
	Blue	Tin plated	770680-5	770669-5	776087-5	776200-5	776228-5
		Gold plated		1-770669-5	1-776087-5	1-776200-5	1-776228-5
35	Black	Tin plated	776164-1	776180-1	776163-1	776230-1	776231-1
		Gold plated		1-776180-1	1-776163-1	1-776230-1	1-776231-1
	Natural	Tin plated	776164-2	776180-2	776163-2	776230-2	776231-2
		Gold plated		1-776180-2	1-776163-2	1-776230-2	1-776231-2
	Gray	Tin plated	776164-4	776180-4	776163-4	776230-4	776231-4
		Gold plated		1-776180-4	1-776163-4	1-776230-4	1-776231-4
	Blue	Tin plated	776164-5	776180-5	776163-5	776230-5	776231-5
		Gold plated		1-776180-5	1-776163-5	1-776230-5	1-776231-5
	Orange	Gold plated	776164-6	1-776180-6	1-776163-6	-	1-776231-6

## Accessories

Wire relief is available as an accessory for the AMPSEAL 23 and 35 position connectors. The wire relief offers a high level of protection and helps reduce strain from the wires.

### ■ Wire Relief

Positions	Part Number	Description
23	776464-1 (one half, two halves required per receptacle housing)	Vertical, sealed receptacle housing wire relief (accepts no. 4 self-tapping screw)
35	776463-1 (one half, two halves required per receptacle housing)	Vertical, sealed receptacle housing wire relief (accepts no. 4 self-tapping screw)



## How To Instructions

### ■ Contact Insertion

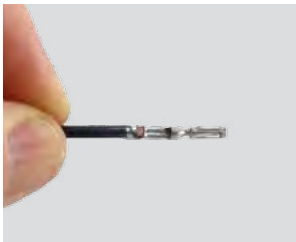

**Step 1:**  
Grasp crimped contact approximately one inch behind the contact barrel.



**Step 2:**  
Check that the wedgelock of the plug assembly is in open position. Align the contact with the applicable cavity.



**Step 3:**  
Insert the contact into the connector cavity until there is an audible or tactile click. A slight tug will verify the contact is locked in place.



**Step 4:**  
After all the contacts have been inserted, close the wedgelock by simultaneously squeezing locking latches inward and pushing the wedgelock into the housing.

## ■ Contact Removal

---



**Step 1:**  
Insert the tip of a screwdriver (2-5mm wide blade) between the edge of the plug assembly housing and one corner of the wedgelock.



**Step 2:**  
Gently pry the edge of the wedgelock until it is released from (but not completely removed) the housing. Repeat these steps for the opposite corner of the wedge.





# AMPSEAL 16 Connectors



## Contents

AMPSEAL 16 Connector Overview	24
Product Documentation	24
Dimensions	24
Configurations	24
Part Numbers	25
Accessories	26
How To Instructions	27

# AMPSEAL 16 Connectors

## AMPSEAL 16 Connector Overview

The AMPSEAL 16 connector system is targeted for off-road, heavy duty industrial, recreational and agricultural applications. This wire-to-wire and wire-to-device connector line was designed to meet the rigorous demands of an industry that requires the highest standards in performance.

The AMPSEAL 16 receptacle and pin housings offer a one-piece approach and come fully assembled.



### ■ Applicable Product Documentation

Additional documentation is available for assistance with AMPSEAL 16 products. The following TE Connectivity document numbers may be helpful:

1654281-2 (Catalog Section)  
 108-2184 (Product Specification)  
 114-13065 (Application Specification)

114-13045 (Application Specification, Contacts)  
 408-8623 (Instruction Sheet)

### ■ Dimensions

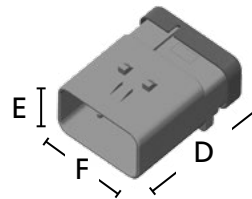
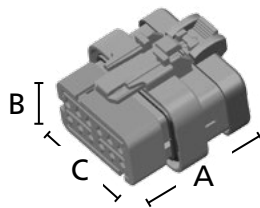

Cavity	AMPSEAL 16 Plug			AMPSEAL 16 Cap		
	Overall Length A	Overall Height B	Overall Width C	Overall Length D	Overall Height E	Overall Width F
2	1.45 (36.75)	.93 (23.5)	.80 (20.33)	1.87 (47.55)	.75 (18.93)	.77 (19.60)
3	1.45 (36.80)	.93 (23.5)	.98 (24.83)	1.87 (47.55)	.75 (19.15)	.95 (24.10)
4	1.44 (36.70)	1.06 (26.8)	1.00 (25.33)	1.87 (47.55)	.88 (22.45)	.97 (24.60)
6	1.44 (36.60)	1.22 (31.0)	1.00 (25.33)	1.87 (47.55)	1.05 (26.65)	.97 (24.60)
8	1.45 (36.80)	1.24 (31.5)	1.15 (29.33)	1.87 (47.55)	1.05 (26.65)	1.13 (28.60)
12	1.45 (36.80)	1.24 (31.5)	1.51 (38.33)	1.87 (47.55)	1.05 (26.65)	1.48 (37.60)

Dimensions are for reference only.

### ■ Configurations

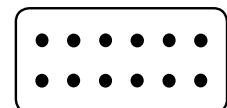
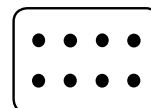
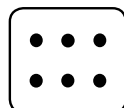
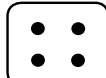
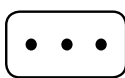

**2 Positions**

2 size 1.58 mm

**3 Positions**

3 size 1.58 mm

**4 Positions**

4 size 1.58 mm

**6 Positions**

6 size 1.58 mm

**8 Positions**

8 size 1.58 mm

**12 Positions**

12 size 1.58 mm

## Part Numbers

Position	PLR Color	Keying	Receptacle Housing (Plug) Standard Dia. Seal	Pin Housing (Cap) Standard Dia. Seal	Receptacle Housing (Plug) - Reduced Dia. Seal	Pin Housing (Cap) - Reduced Dia. Seal
2	Red	Key A	776427-1	776428-1	776522-1	776534-1
	Gray	Key B	776427-2	776428-2	776522-2	776534-2
	Yellow	Key C	776427-3	776428-3	776522-3	776534-3
	Green	Key D	776427-4	776428-4	776522-4	776534-4
3	Red	Key A	776429-1	776430-1	776523-1	776535-1
	Gray	Key B	776429-2	776430-2	776523-2	776535-2
	Yellow	Key C	776429-3	776430-3	776523-3	776535-3
	Green	Key D	776429-4	776430-4	776523-4	776535-4
4	Red	Key A	776487-1	776488-1	776524-1	776536-1
	Gray	Key B	776487-2	776488-2	776524-2	776536-2
	Yellow	Key C	776487-3	776488-3	776524-3	776536-3
	Green	Key D	776487-4	776488-4	776524-4	776536-4
6	Red	Key A	776433-1	776434-1	776531-1	776537-1
	Gray	Key B	776433-2	776434-2	776531-2	776537-2
	Yellow	Key C	776433-3	776434-3	776531-3	776537-3
8	Red	Key A	776494-1	776495-1	776532-1	776538-1
	Gray	Key B	776494-2	776495-2	776532-2	776538-2
	Yellow	Key C	776494-3	776495-3	776532-3	776538-3
	Green	Key D	776494-4	776495-4	776532-4	776538-4
12	Red	Key A	776437-1	776438-1	776533-1	776539-1
	Gray	Key B	776437-2	776438-2	776533-2	776539-2
	Yellow	Key C	776437-3	776438-3	776533-3	776539-3
	Green	Key D	776437-4	776438-4	776533-4	776539-4

Receptacle housing (plug) and pin housing (cap) PLR colors are mechanically keyed to mate only with identical colors.

Part Number Suffix:

- 1 = A key (**red PLR**)
- 2 = B key (**gray PLR**)
- 3 = C key (**yellow PLR**)
- 4 = D key (**green PLR**)

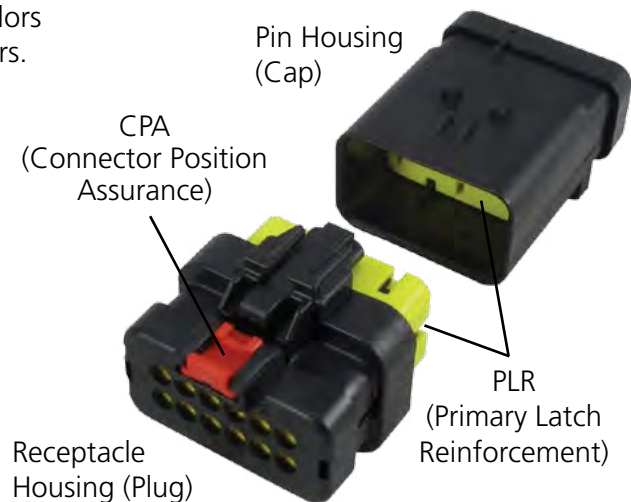



# AMPSEAL 16 Connectors

## Accessories

Mounting clips and backshells are accessory items available for use with AMPSEAL 16 connectors. These accessories cover design requirements by assisting with mounting, providing additional protection, and offering increased aesthetics.

### ■ Mounting Clips

Mounting Clip	Part Number	Description
	1924487-1	Mounting clip without anti-rotational feature
	1924487-2	Mounting clip with anti-rotational feature

### ■ Backshells



Number of Positions	Conduit Size	Part Numbers			
		Standard Straight	Standard 90°	Low Profile 90° Rec. Housing	Low Profile 90° Pin Housing
2	NC08/NW7.5	2035047-1 <sup>†</sup>	2035048-1 <sup>†</sup>	2035366-1	2098436-1
	NC12/NW10	-	2035048-5 <sup>†</sup>	2035366-3	2098436-3
3	NC08/NW7.5	2035047-2 <sup>†</sup>	2035048-2 <sup>†</sup>	2035366-2	2098436-2
	NC12/NW10	-	2035048-6 <sup>†</sup>	2035366-4	2098436-4
4	NC08/NW7.5	2035047-3 <sup>†</sup>	2035048-3 <sup>†</sup>	2035366-7	2098436-7
	NC12/NW10	2035047-5 <sup>†</sup>	2035048-7 <sup>†</sup>	2035366-9	2098436-9
	NC16/NW13	-	-	1-2035366-1	1-2098436-1
6	NC08/NW7.5	2035047-4 <sup>†</sup>	-	2035366-8	2098436-8
	NC12/NW10	2035047-6 <sup>†</sup>	-	1-2035366-0	1-2098436-0
	NC16/NW13	-	-	1-2035366-2	1-2098436-2
8	NC12/NW10	2035047-7 <sup>†</sup>	-	-	-
	NC16/NW13	2035047-9 <sup>†</sup>	2035047-9 <sup>†</sup>	-	-
12	NC12/NW10	2035047-8 <sup>†</sup>	-	-	-
	NC16/NW13	1-2035047-0 <sup>†</sup>	-	-	-
	NC20/NW17	1-2035047-1 <sup>†</sup>	-	-	-

<sup>†</sup> = Backshell available only with latch window. Can be used for cap assembly if desired.

## How To Instructions

### ■ Contact Insertion



**Step 1:**  
Grasp crimped contact approximately one inch behind the contact barrel.



**Step 2:**  
Verify the PLR is in the pre-staged position, unlocked.



**Step 3:**  
Align the contact with the desired circuit cavity at the rear of the housing assembly.



**Step 4:**  
Push the contact straight into the connector cavity until the contact retention finger returns to its normal position behind the retention shoulder on the contact. A slight tug will verify the contact is locked in place.

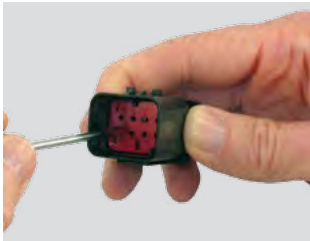

**Step 5:**  
When all of the required contacts have been inserted, push the PLR into the fully locked position.

### ■ Contact Removal



**Step 1:**  
Insert the removal tool into the PLR extraction slot and pull until the PLR is completely removed from the housing.



**Step 2:**  
Insert the tool into the contact cavity and deflect the contact retention finger.



**Step 3:**  
Gently pull the wire until the contact is free from the housing.



# DRB Series



## Contents

DRB Series Overview 30

---

Part Numbering System 30

---

Dimensions 30

---

Configurations 31

---

Required Components 32-33

---

Accessories 33

---

How To Instructions 34-35

---

## DRB Series Overview

The DRB Series connectors are heavy duty connectors suitable for bulkhead applications. They are designed to accommodate multiple wire gauges and feature high pin counts, including 48, 60, 102, and 128 cavities. To increase the design flexibility, the DRB Series offers several mounting flange options and wire arrangements. The DRB Series is suited for on- and off-highway applications, marine, industrial, and agriculture markets in harsh environments.



### Part Numbering System

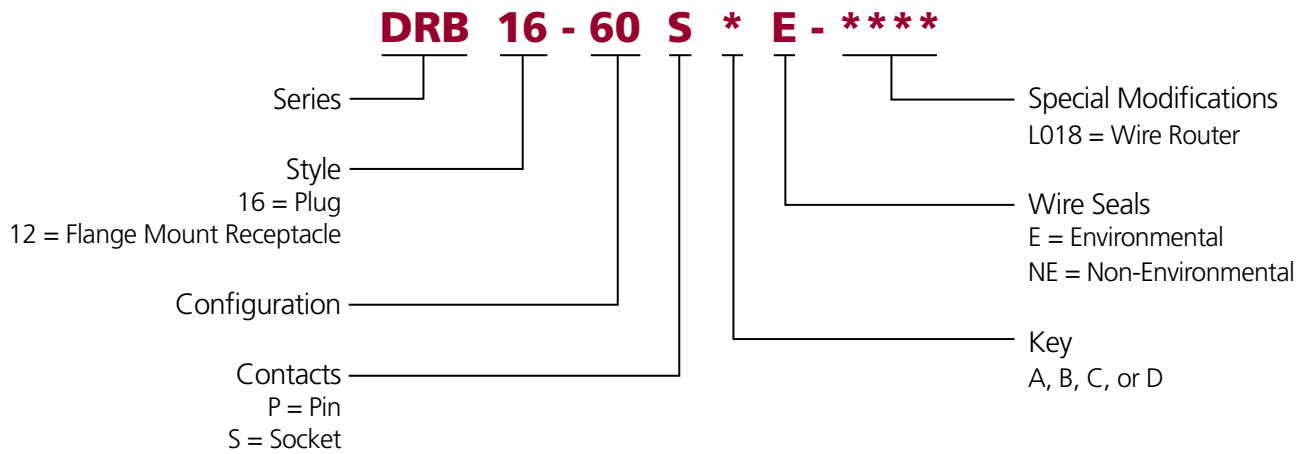

### Dimensions



Cavity	DRB Plug			DRB Receptacle		
	Overall Length A	Overall Height B	Overall Width C	Overall Length D	Overall Height E	Overall Width F
48 & 60	1.406 (35.71)	2.606 (66.19)	2.606 (66.19)	2.077 (52.76)	2.606 (66.19)	2.606 (66.19)
102	1.778 (45.16)	2.966 (75.34)	4.951 (125.76)	2.291 (58.19)	2.966 (75.34)	4.951 (125.76)
128	1.748 (44.40)	2.966 (75.34)	4.951 (125.76)	2.291 (58.19)	2.966 (75.34)	4.951 (125.76)

Dimensions are for reference only.



## ■ Configurations

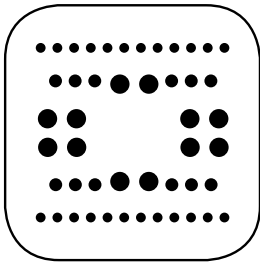
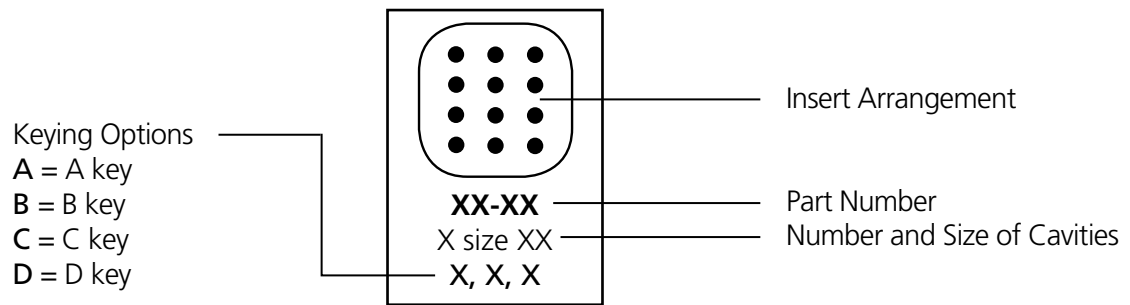

**DRB1\*-48\*\***  
 12 size 12  
 12 size 16  
 24 size 20  
 A, B, C, D

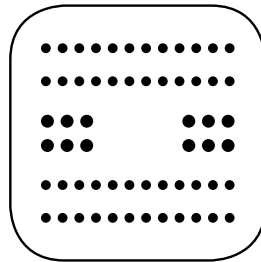

**DRB1\*-60\*\***  
 12 size 16  
 48 size 20  
 A, B, C, D

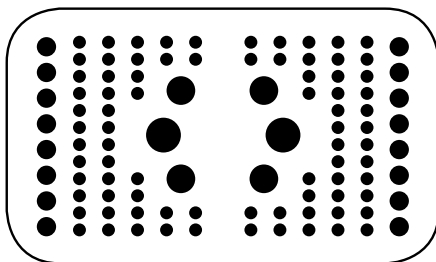

**DRB1\*-102\*\*\***  
 2 size 4  
 4 size 8  
 16 size 12  
 80 size 16  
 A, B, C, D

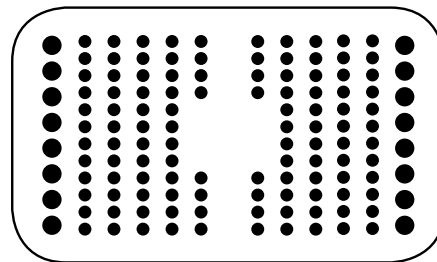

**DRB1\*-128\*\*\***  
 16 size 12  
 112 size 16  
 A, B, C, D





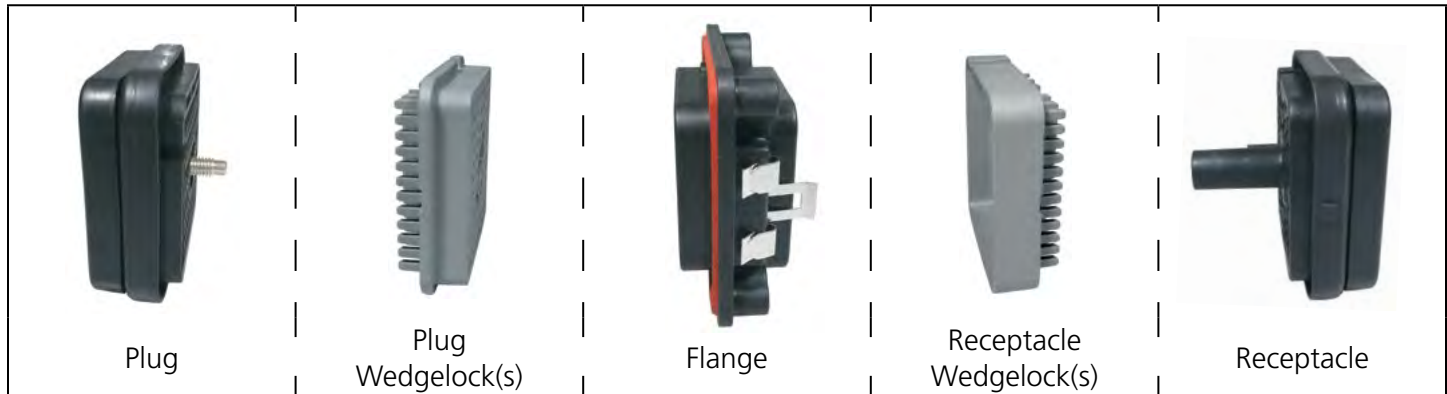

## Required Components

### Required Components

A complete DRB assembly requires a wedgelock for each plug and receptacle and a mounting flange. There are several flange options to accommodate design requirements. The wedgelocks are required to confirm proper contact placement.



### Flange Options

Flange	Part Number	Accept Connectors	Description
	DRBF-2*	(1) DRB 48 or 60 Way	Single mounting flange for one 48 or 60 way DRB plug and receptacle mated pair
	DRBF-3**	(2) DRB 48 or 60 Ways	Double mounting flange for any combination of two 48 or 60 way DRB plug and receptacle mated pairs
	DRBF-1*	(1) DRB 102 Way or (1) DRB 128 Way	Single mounting flange for the 102 or 128 way DRB plug and receptacle mated pair
	DRBM-3*	(1) DRB 102 Way or (1) DRB 128 Way	Single mounting flange for the 102 or 128 way DRB plug and receptacle mated pair, includes two 125 amp mounting posts

\*A, B, C, D keying available

## ■ Secondary Wedgelocks

DEUTSCH DRB electrical connectors require secondary wedgelocks which are sold separately. The wedgelocks confirm proper contact alignment and offer keying options within each connector. Secondary wedgelocks are assembled at the mating interfaces and click into place.

Receptacle	
WB-48P*	Wedgelock for 48 way receptacle
WB-60P*	Wedgelock for 60 way receptacle
WB-51P*L	Left wedgelock for 102 way receptacle
WB-51P*R	Right wedgelock for 102 way receptacle
WB-64P*	Wedgelock for 128 way receptacle (requires two)

Plug	
WB-48S*	Wedgelock for 48 way plug
WB-60S*	Wedgelock for 60 way plug
WB-51S*L	Left wedgelock for 102 way plug
WB-51S*R	Right wedgelock for 102 way plug
WB-64S*	Wedgelock for 128 way plug (requires two)

\*A, B, C, D keying available



## Accessories

### ■ Boots



Boots provide a professional looking finishing touch for DEUTSCH DRB Series connectors. Made of durable plastisol, these slip-on boots are not only aesthetically appealing, but also provide increased protection from dirt, paint overspray, and pressure washing. The plastisol boots are rated from -20° F to +212° F and offer a slip-on design making installation quick and easy.



#### Boot

Part Number	Description
DRB48-60-BT	48 way plug or receptacle boot, black
DRB48-60-BT	60 way plug or receptacle boot, black
DRB102-BT	102/128 way plug or receptacle boot, black
DRB102-BT-90DEG	102/128 way plug or receptacle boot, 90° bend, black

\*Distorting the boots can lessen their longevity

## How To Instructions

### ■ Assembly



**Step 1:**  
Wedgelocks should be pressed firmly in place, with only a slight gap showing between the wedgelock and connector.



**Step 2:**  
If the wedgelock will not go all the way in, check to make sure all of the contacts are properly seated.

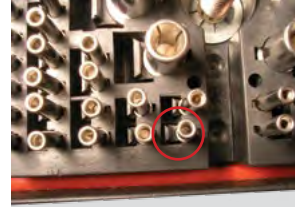

**Step 3:**  
Contacts should be fully inserted into the connector, with the locking fingers in place under the shoulder of the contact. If a contact is not fully inserted, the retention finger will prevent the wedgelock from pressing into place.

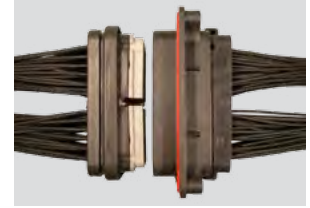

**Step 4:**  
When mating the plug with the receptacle, confirm that the plug is not being pulled into the receptacle at an angle by the jackscrew.

Improper assembly can cause the jackscrew to be stripped during assembly. To prevent damage, the jackscrew will strip out before the threads in the connector are damaged. If the jackscrew becomes stripped, please replace the jackscrew and the push nut.

### *Notice*

Do not over torque jackscrew. The recommended torque rating for the DRB Series plug jackscrew when tightening is 30-35 IN-LB (3.38-3.95 N.M.).

### ■ Contact Insertion



**Step 1:**  
Hold connector with rear grommet/wire router cap facing you.



**Step 2:**  
Push contact straight into contact cavity until a click is heard/felt. A slight tug will confirm the contact is inserted correctly.



**Step 3:**  
Once all contacts are in place, insert wedgelock by lining up the keyway. The wedgelock will press into place.

## ■ Contact Removal

---



**Step 1:**  
Remove wedgelock using a screwdriver. Pull wedgelock straight out.

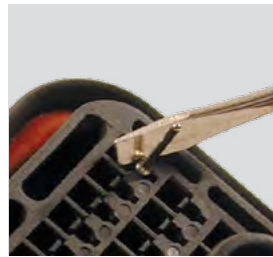

**Step 2:**  
To remove contacts, gently pull wire backwards, while at the same time releasing the locking finger by moving it away from the contact with a screwdriver.



# DRC Series



## Contents

DRC Series Overview	38
Part Numbering System	38
Connector Styles	38
Dimensions	39
Mating	39
Configurations	40
Accessories	41-42

## DRC Series Overview

The environmentally sealed DRC Series is a rectangular connector series that offers insert arrangements of 24, 40, 50, 60, 64, 70, and 76 cavities and accepts size 12, 16, and 20 contacts. Several mounting options are available including in-line, flange mount, and PCB mount.



### Part Numbering System

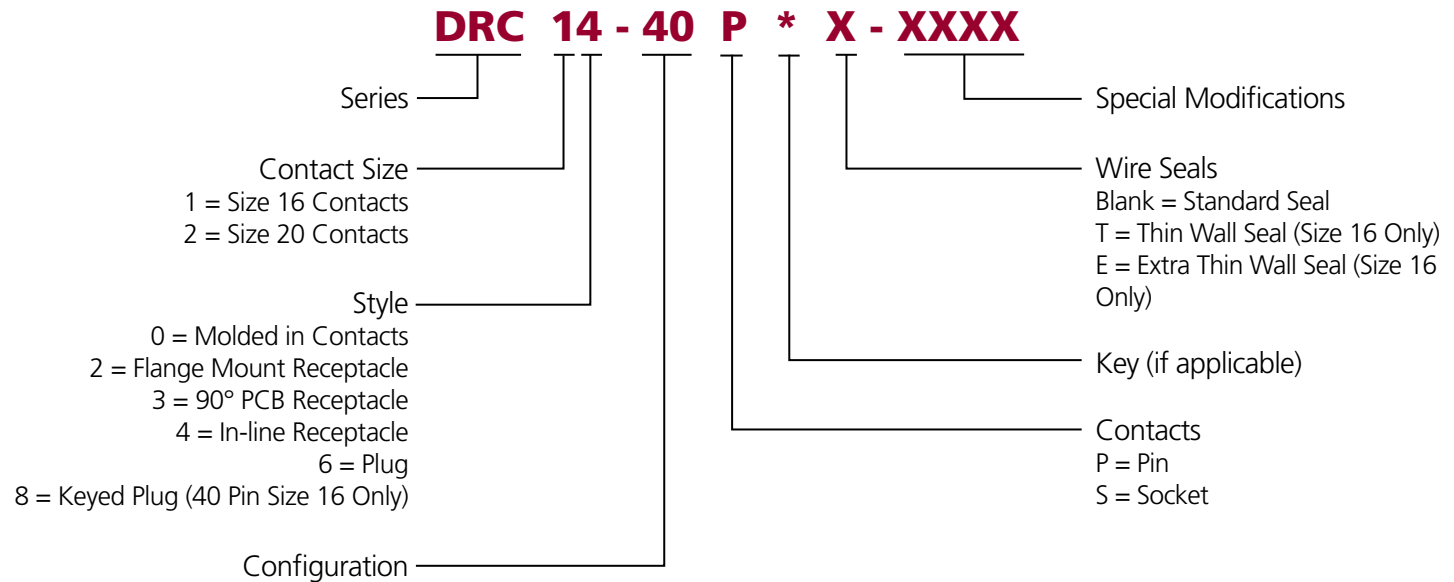

### Connector Styles

In-line Receptacle

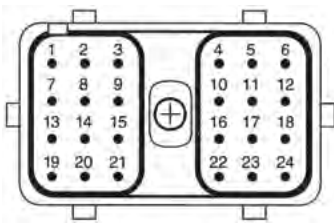

Flange Mount Receptacle

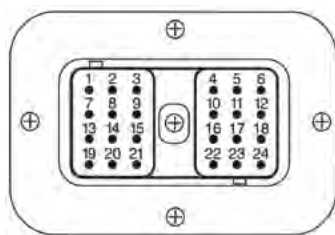

PCB Receptacle

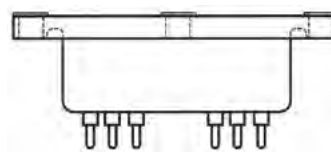

Standard Plug

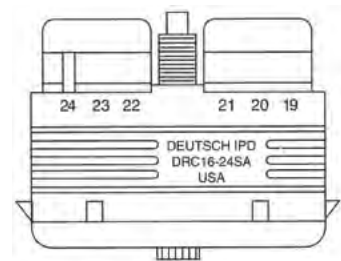



## ■ Dimensions



Cavity	DRC Plug			DRC Receptacle		
	Overall Length A	Overall Height B	Overall Width C	Overall Length D	Overall Height E	Overall Width F
24 (sz. 20)	1.435 (36.45)	1.244 (31.60)	2.004 (50.90)	1.785 (45.34)	1.500 (38.10)	3.104 (78.84)
24 (sz. 16)	1.600 (40.64)	1.148 (29.16)	2.100 (53.34)	1.742 (44.25)	1.202 (30.53)	2.154 (54.71)
38	1.435 (36.45)	1.274 (32.36)	2.700 (68.58)	--	--	--
40 (sz. 20)	1.380 (35.05)	1.244 (31.60)	2.700 (68.58)	1.785 (45.34)	1.500 (38.10)	3.800 (96.52)
40 (sz. 16)	1.597 (40.56)	1.202 (30.53)	2.868 (72.85)	1.699 (43.15)	1.202 (30.53)	2.908 (73.86)
50	1.435 (36.45)	1.408 (35.76)	2.700 (68.58)	--	1.987 (50.47)	3.094 (78.59)
60	1.435 (36.45)	1.448 (36.78)	2.700 (68.58)	--	2.161 (54.89)	3.094 (78.59)
64	--	--	--	1.785 (45.34)	1.500 (38.10)	5.866 (149.00)
70	1.643 (41.73)	1.421 (36.09)	4.094 (103.99)	1.757 (44.63)	1.421 (36.09)	4.094 (103.99)
76	--	--	--	1.115 (28.32)	1.827 (46.41)	5.686 (144.42)

Dimensions are for reference only.

## ■ Mating Criteria

The DEUTSCH DRC Series plugs are keyed to provide positive alignment and to prevent mis-mating.

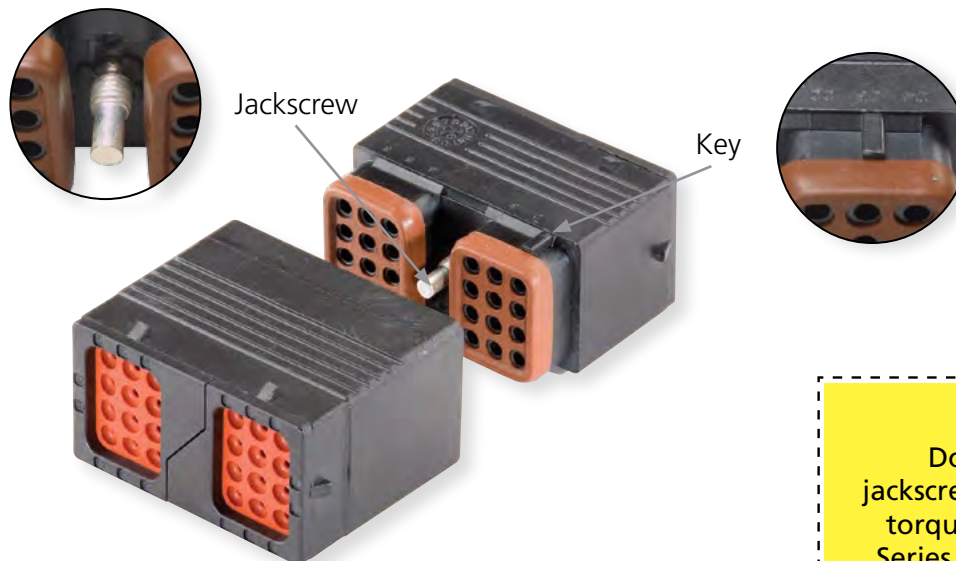

*Notice*

Do not over torque jackscrew. The recommended torque rating for the DRC Series plug jackscrew when tightening is 25-28 IN-LB (2.83-3.16 N.M.).

## ■ Configurations

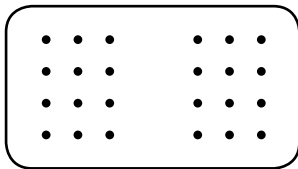
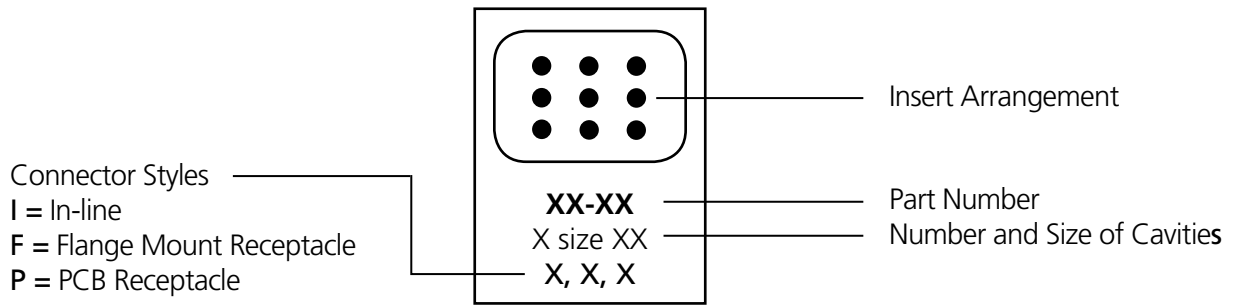

**DRC2\*-24\*\***  
 24 size 20  
 I, F, P

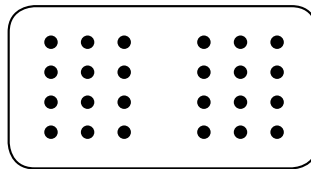

**DRC1\*-24\*\***  
 24 size 16  
 I, F, P

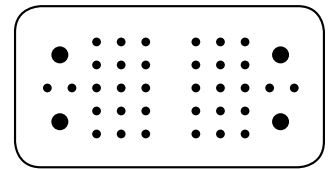

**DRC26-38\*\***  
 34 size 20, 4 size 12  
 (Plug for DRC20-76P\*\*\*\*)

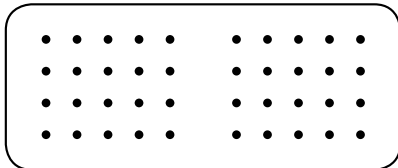

**DRC2\*-40\*\***  
 40 size 20  
 F, P

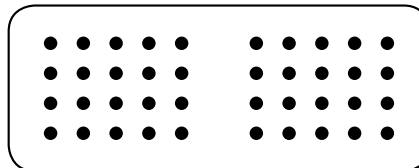

**DRC1\*-40\*\***  
 40 size 16  
 I, F, P

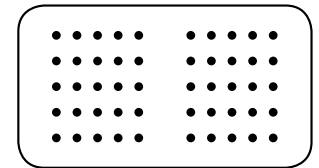

**DRC2\*-50\*\***  
 50 size 20  
 P

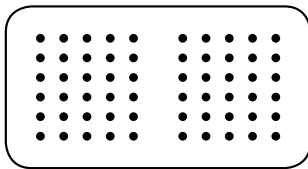

**DRC2\*-60\*\***  
 60 size 20  
 P

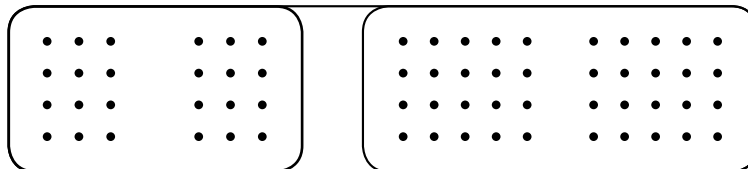

**DRC2\*-64\*\***  
 64 size 20  
 P

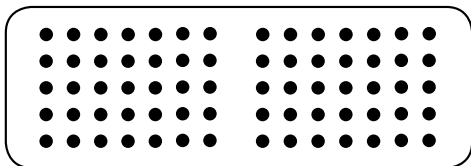

**DRC1\*-70\*\***  
 70 size 16  
 I, F, P

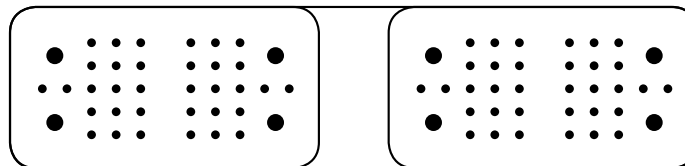

**DRC20-76P\*\*\*\***  
 68 size 20, 8 size 12  
 P

## Accessories

Several accessory items are available to complement the connectors including boots, gaskets, backshells, and wire routers. Accessories are designed to complete the application and meet a wide array of design requirements such as providing additional protection and offering increased aesthetics.

### ■ Backshells

The DEUTSCH DRC Series backshells are designed to snap onto the back of the connectors and accept convoluted tubing. The rigid, durable backshells offer a high level of protection, provide strain relief, and improve aesthetics.

#### Backshells and Wire Routers

Connector Cavities	Part Number	Description
38	0528-003-3805	90° backshell to the side, plug
38	0528-004-3805	90° backshell, plug
38	0528-005-3805	90° low profile backshell, plug
40	0515-015-4005	Wire router, plug
50	0528-001-5005	90° backshell, plug
60	0528-002-6005	90° backshell, plug
60	0528-007-6005	90° backshell to the side, plug
70	0515-029-7005	Straight wire router, plug
70	0515-031-7005	Straight wire router, plug or receptacle,
70	0528-006-7005	Straight backshell, plug or receptacle, requires two halves and wire router
70	0528-012-7005	90° backshell to the side, plug or receptacle, without tubing rib
70	0525-013-7005	90° backshell to the side, plug or receptacle, with tubing rib



### ■ Boots



Boots provide a professional looking finishing touch for DEUTSCH DRC Series connectors. Made of durable plastisol, these slip-on boots are not only aesthetically appealing, but also provide increased protection from dirt, paint overspray, and pressure washing. The plastisol boots are rated from -20° F to +212° F and offer a slip-on design making installation quick and easy.



#### Boot

Part Number	Description
DRC24-BT	24 way boot, size 16 contact arrangements, black
DRC26-24BT	24 way boot, size 20 contact arrangements, black
DRC40-BT	40 way boot, size 16 contact arrangements, black
DRC40-BT-90DEG	40 way boot, size 16 contact arrangements, 90° bend, black
DRC26-40BT	40 way boot, size 20 contact arrangements, black
DRC70-BT	70 way boot, size 16 contact arrangements, black

\*Distorting the boots can lessen their longevity

## ■ Gaskets

---



Moisture, dirt, salt, sand, and road debris can all work their way into electrical panels through unsealed mounting flanges. Rated to operate in environments from -70°F to +225°F, these rugged high quality neoprene gaskets form a tight seal between the panel face and connector flange to help keep out destructive elements. The gaskets have a thickness of .125" and meet the UL-94-HBF, Mil-R-6130C, and FMVSS-302 flammability specifications.



Gasket P/N	Connector P/N
DRC24-GKT	DRC12-24P**
DRC40-GKT	DRC12-40P**
DRC70-GKT	DRC12-70P**

# DT Family

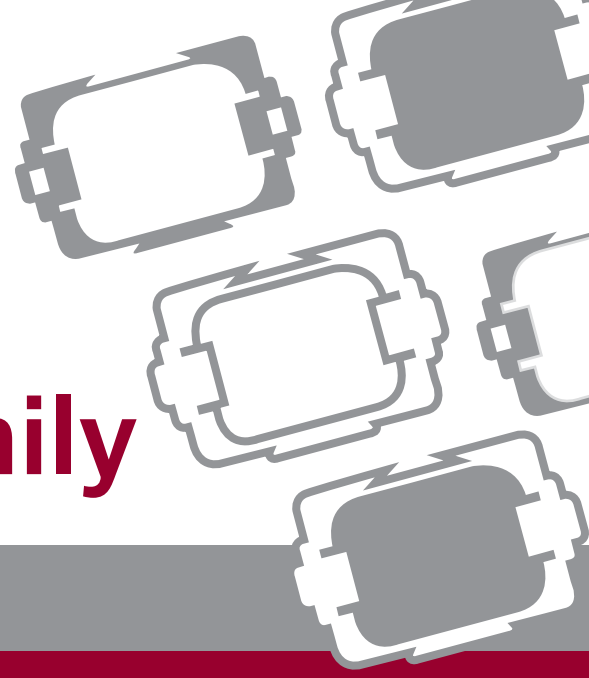

## Contents

DT Family Overview	44	Printed Circuit Board	55
Part Numbering System	44	DTV Series	56
Dimensions	45	DTMH Series & High Temperature Modification	57-58
Configurations	46	DTMN Series	59
Required Components	47-48	How To Instructions	60
Special Modifications	48-49		
Accessories	50-54		

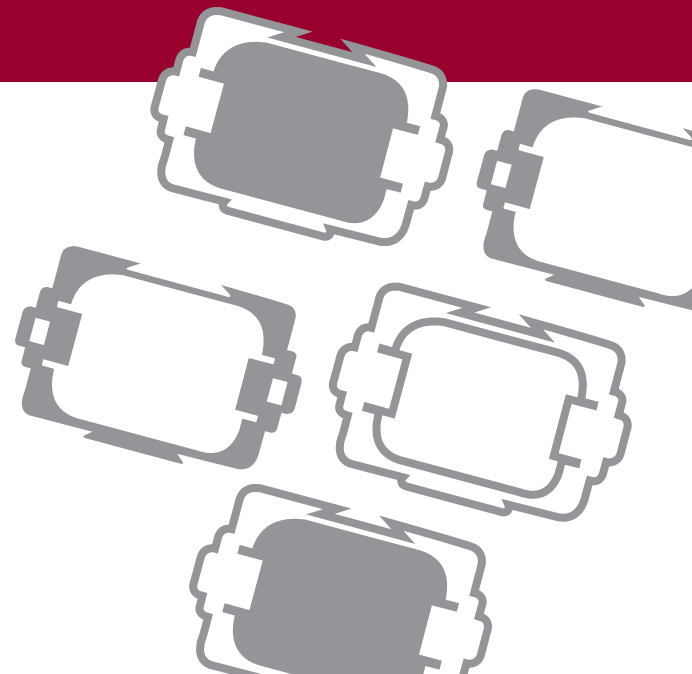

## DT Family Overview

DEUTSCH DT, DTM, and DTP Series environmentally sealed connectors are designed specifically for cable to cable applications. The DT connectors are used in harsh environment applications where even a small degradation in connection may be critical. Thermoplastic housings offer a wide operating temperature range and silicone rear wire and interface seals allow the connectors to withstand conditions of extreme temperature and moisture.

The connector may be populated with either solid or stamped & formed style contacts. Contact insertion and removal does not require any special tools. Contacts are retained in locked position by dielectric fingers which are molded as an integral part of the housing. Secondary wedgelocks are assembled at the mating interfaces to provide proper contact positioning.

The DEUTSCH DT Series general purpose connectors will provide reliability and performance on the engine or transmission, under the hood, on the chassis, or in the cab.

### DT Series Overview

DEUTSCH DT Series connectors offer field proven reliability and rugged quality. The DT design strengths include optional flange mounting, multi-pin arrangements, and design flexibility. The DT Series offers the designer the ability to use multiple size 16 contacts, each with 13 amp continuous capacity, within a single shell.

### DTP Series Overview

DEUTSCH DTP Series connectors provide solutions for your power application requirements. Building on both the DT and DTM design strengths, the DTP connector line was developed to fill the need for higher amperage, multi-pin, inexpensive connectors.

The DTP Series offers the designer the ability to use multiple size 12 contacts, each with 25 amp continuous capacity, within a single shell. The DTP connectors are currently available in two and four pin configurations.

### DTM Series Overview

DEUTSCH DTM Series connectors offer solutions to your smaller wire gauge applications. Building on the DT design strengths, the DTM connector line was developed to fill the need for lower amperage, multi-pin, inexpensive connectors. The DTM Series offers the designer the ability to use multiple size 20 contacts, each with 7.5 amp continuous capacity, within a single shell.



### DT Family Part Numbering System

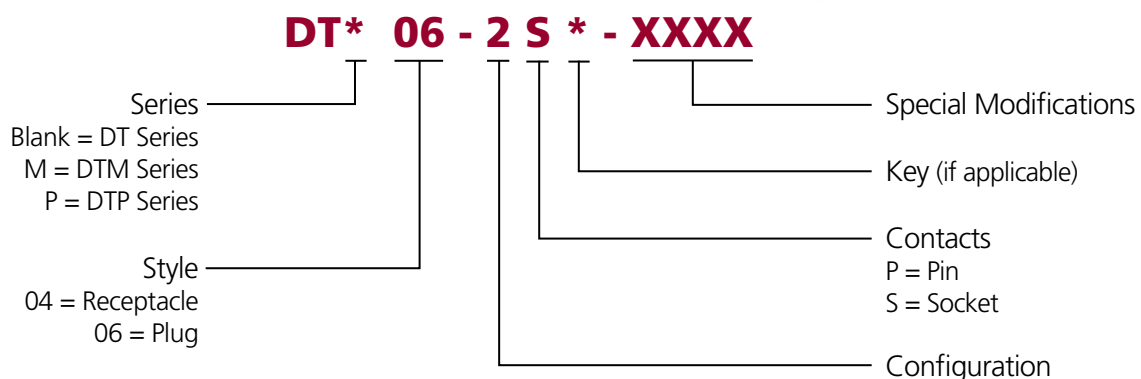

## DT Series Dimensions

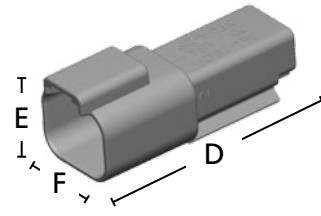
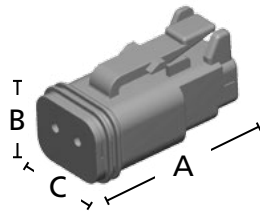

Cavity	DT Plug			DT Receptacle		
	Overall Length A	Overall Height B	Overall Width C	Overall Length D	Overall Height E	Overall Width F
2	1.118 (28.4)	.628 (15.95)	.591 (15.01)	1.708 (43.38)	.670 (17.02)	.675 (17.15)
3	1.118 (28.4)	.934 (23.72)	.718 (18.23)	1.698 (43.13)	.973 (24.71)	.832 (21.13)
4	1.218 (30.94)	.724 (18.39)	.716 (18.19)	1.808 (45.92)	.776 (19.71)	.820 (20.83)
6	1.218 (30.94)	.891 (22.63)	.716 (18.19)	1.808 (45.92)	.951 (24.16)	.820 (20.83)
8	1.217 (30.91)	.776 (19.71)	1.465 (37.21)	1.798 (45.67)	1.000 (25.40)	1.435 (36.45)
12	1.218 (30.94)	.716 (18.19)	1.597 (40.56)	1.808 (45.92)	.876 (22.25)	1.597 (40.56)

Dimensions are for reference only.

## DTM Series Dimensions

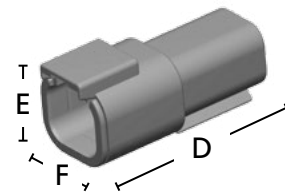
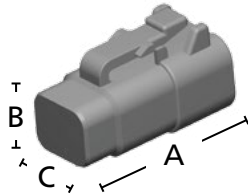

Cavity	DTM Plug			DTM Receptacle		
	Overall Length A	Overall Height B	Overall Width C	Overall Length D	Overall Height E	Overall Width F
2	1.085 (27.56)	.508 (12.90)	.475 (12.07)	1.620 (41.15)	.638 (16.21)	.651 (16.54)
3	1.085 (27.56)	.551 (14.00)	.640 (16.26)	1.620 (41.15)	.638 (16.21)	.861 (20.73)
4	1.185 (30.10)	.695 (17.65)	.600 (15.24)	1.720 (43.69)	.772 (19.61)	.756 (19.20)
6	1.185 (30.10)	.817 (20.75)	.600 (15.24)	1.720 (43.69)	.937 (23.80)	.756 (19.20)
8	1.185 (30.10)	.600 (15.24)	1.245 (31.62)	1.720 (43.69)	.796 (20.22)	1.245 (31.62)
12	1.185 (30.10)	.600 (15.24)	1.575 (40.01)	1.720 (43.69)	.796 (20.22)	1.575 (40.01)

Dimensions are for reference only.

## DTP Series Dimensions

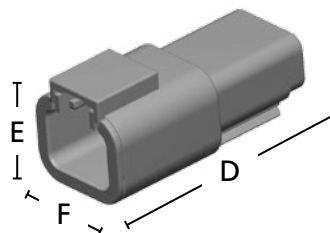
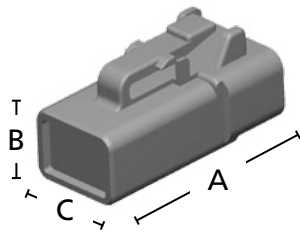

Cavity	DTP Plug			DTP Receptacle		
	Overall Length A	Overall Height B	Overall Width C	Overall Length D	Overall Height E	Overall Width F
2	1.364 (34.65)	.711 (18.06)	.732 (18.59)	1.861 (47.27)	.869 (22.07)	.972 (22.15)
4	1.364 (34.65)	.960 (24.38)	.868 (22.05)	1.861 (47.27)	1.069 (27.15)	1.060 (26.92)

Dimensions are for reference only.

# DT Family

## DT Family Connector Configurations

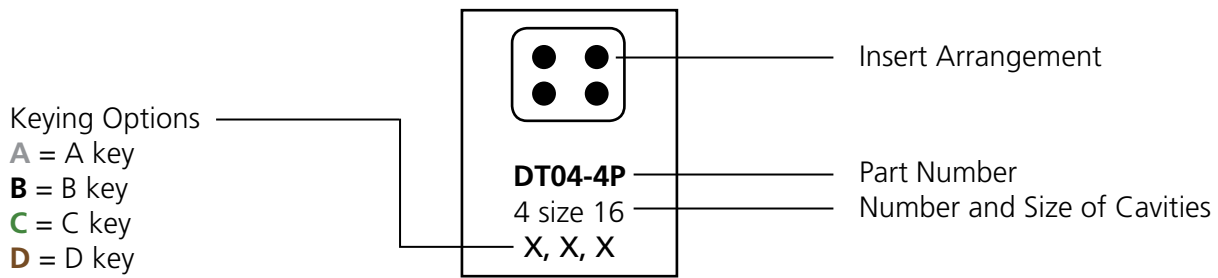

## DT Series Configurations

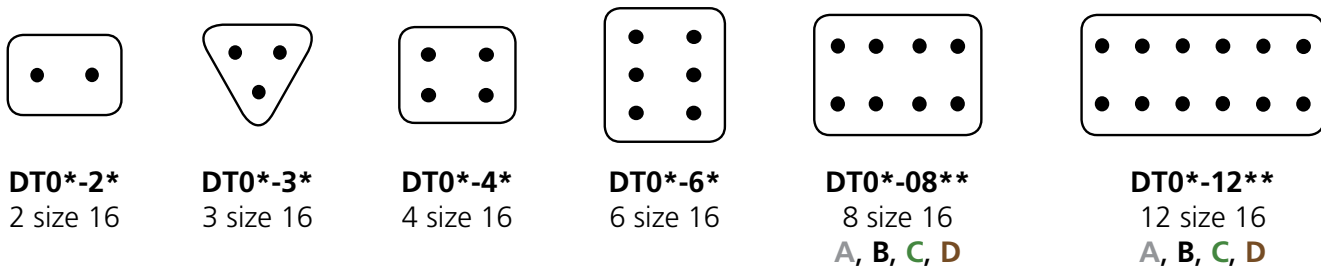

## DTM Series Configurations

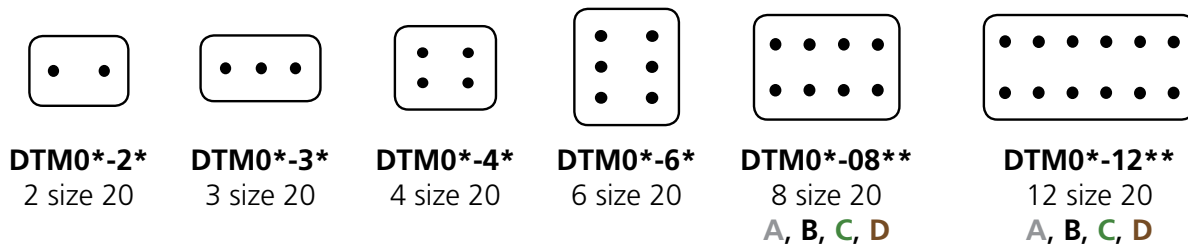

## DTP Series Configurations

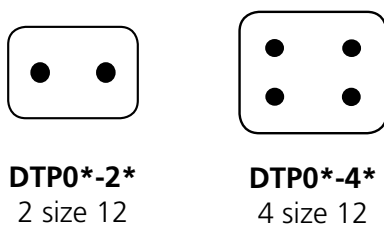



## Required Components





### ■ Secondary Wedgelocks

DEUTSCH DT style electrical connectors require secondary wedgelocks which are sold separately. The wedgelocks help ensure proper contact alignment within each connector. Secondary wedgelocks are assembled at the mating interface and click into place. If by chance the secondary wedgelocks are not properly seated during assembly, they will be pressed into locked position during the mating of the connector.

Adding to the design flexibility of the DT Series, several wedgelocks offer keying options. Wedgelocks for enhanced seal retention plugs (P012) are also available.



#### DT Series Wedgelocks



Receptacle		
	W2P*	Wedgelock for 2 way receptacle *A, B, C, D keying available
	W3P*	Wedgelock for 3 way receptacle *J1939 keying available
	W4P*	Wedgelock for 4 way receptacle *A, B, C, D keying available
	W6P	Wedgelock for 6 way receptacle
	W8P	Wedgelock for 8 way receptacle
	W12P	Wedgelock for 12 way receptacle

Plug		
	W2S*	Wedgelock for 2 way plug *A, B, C, D keying available
	W3S*	Wedgelock for 3 way plug *J1939 keying available
	W4S*	Wedgelock for 4 way plug *A, B, C, D keying available
	W6S	Wedgelock for 6 way plug
	W8S	Wedgelock for 8 way plug
	W12S	Wedgelock for 12 way plug

*Notice*  
Wedgelocks for enhanced plugs (P012) are available.





#### DTP Series Wedgelocks



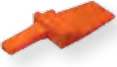
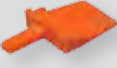

Receptacle		
	WP-2P	Wedgelock for 2 way receptacle
	WP-4P	Wedgelock for 4 way receptacle

Plug		
	WP-2S	Wedgelock for 2 way plug
	WP-4S	Wedgelock for 4 way plug

# DT Family

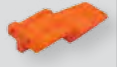
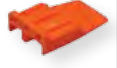
## DTM Series Wedgelocks

Receptacle		
	WM-2P*	Wedgelock for 2 way receptacle *A, B, C keying available
	WM-3P	Wedgelock for 3 way receptacle
	WM-4P	Wedgelock for 4 way receptacle
	WM-6P	Wedgelock for 6 way receptacle
	WM-8P	Wedgelock for 8 way receptacle
	WM-12P	Wedgelock for 12 way receptacle

Plug		
	WM-2S*	Wedgelock for 2 way plug *A, B, C keying available
	WM-3S	Wedgelock for 3 way plug
	WM-4S	Wedgelock for 4 way plug
	WM-6S	Wedgelock for 6 way plug
	WM-8S	Wedgelock for 8 way plug
	WM-12S	Wedgelock for 12 way plug

## Special Modifications

The DT Series connectors offer several modifications to enhance the design flexibility and meet application specific needs. Options include enhanced seal retention, flanges, and connector body color just to mention a few. By combining the DT Series connectors with the available modifications and accessories, the design possibilities are immense.

### ■ B016 Modification

The B016 receptacle modification helps prevent mis-mating. The B016 is available for the DT 12 way connectors, DT13/15, and DTF13/15 PCB Series connectors. In addition to the four keying positions (A, B, C, or D) and color coding, the B016 enhancement gives the user both visual and tactile proof of correct mating, thus eliminating mis-mating opportunities during assembly.

Please note the P012 plug is the required mate for the B016 receptacle to make the enhancement effective.

### ■ P012 Modification

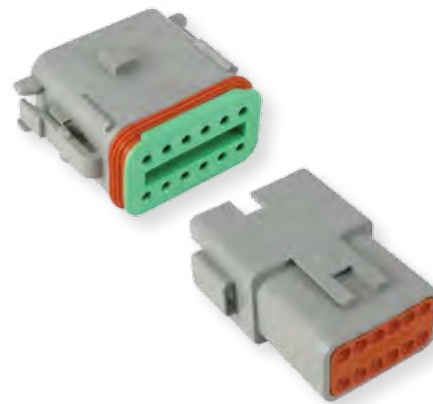

The DT P012 plugs provide enhanced front seal retention resulting in an ultra tight environmental seal. The enhanced seal retention keeps the seal in place during mating and unmating. The P012 modification requires an enhanced P012 wedgelock. The DEUTSCH P012 modification is available in 2, 3, 4, 6, 8, and 12 cavity arrangements. P012 plugs have a black connector body except for the 8 and 12 cavity arrangements, where the color is based on the key.

## ■ E007 & E008 Modification

To meet the application requirements where wires need added protection, the DT (E008) and DTM (E007) Series may be supplied with shrink boot adapters. These adapters accept shrink tubing.



## ■ C015 Modification

The C015 modification offers a reduced diameter insert cavity allowing for a proper seal with smaller wire insulation. The C015 modification is also referred to as an "E" seal.



## ■ E004 Modification

The E004 modification changes the connector body color to black.



## ■ Flange Modifications

Designed to simplify wire routing and assembly, DT Series receptacles are available in many mounting configurations and styles.

### Welded flange

- Welded flange - BL04, BL08, CL03, L012, LE14
- Welded flange, end cap - LE07, LE11
- Welded flange, shrink boot adapter - LE08, LE12

### Sealed flange

- Sealed flange, end cap - CL09, LE01, LE05, LE06, LE09, LE10, LE17, LE21
- Sealed flange, shrink boot adapter - BL10, CL07



## ■ E003 Modification

The E003 modification offers a protective end cap attached to the rear of the connector. There are holes in the cap to allow the contacts to be inserted.



## ■ E005 Modification

The E005 modification offers a protective end cap attached to the rear of the connector and has a black connector body.



### *Notice*

Additional modifications are available, please contact your representative.

## Accessories

Several accessory items are available to complement the connectors including boots, backshells, gaskets, dust caps, and mounting clips. Accessory items cover a wide array of design requirements such as assisting with mounting, providing additional protection, and offering enhanced aesthetics.

### Gaskets



Moisture, dirt, salt, sand, and road debris can all work their way into electrical panels through unsealed mounting flanges. Rated to operate in environments from -70°F to +225°F, these rugged high quality neoprene gaskets form a tight seal between the panel face and connector flange to help keep out destructive elements. The gaskets have a thickness of .125" and meet the UL-94-HBF, Mil-R-6130C, and FMVSS-302 flammability specifications.



Gasket P/N	Connector P/N
DT3P-L012-GKT	DT04-3P-L012
DT4P-L012-GKT	DT04-4P-L012
DTP4P-L012-GKT	DTP04-4P-L012
DT8P-L012-GKT	DT04-08P*-L012
DT12-L012-GKT	DT04-12P*-L012 DTM04-12P*-L012

### Dust Caps



The DT Series dust caps are made of either thermoplastic or durable plastisol and are designed to provide protection for the connector interface when the two halves are not mated. The plastisol caps, available for plugs and receptacles, are ideal for providing temporary protection from dirt, dust, and paint overspray. The thermoplastic caps provide an environmental seal for an unmated plug.



Thermoplastic Dust Cap P/N	Connector P/N
1011-344-0205	DT06-2S
1011-345-0305	DT06-3S
1011-346-0405	DT06-4S
1011-347-0605	DT06-6S
1011-348-0805	DT06-08S*
1011-349-1205	DT06-12S*, DT16-15S*, DT16-18S*



Plastisol Dust Cap P/N	Connector P/N
DTM3S-DC	DTM06-3S
DT3P-DC	DT04-3P
DT4P-DC	DT04-4P
DT6P-DC	DT04-6P
DTM12P-DC	DTM04-12P*
DT12P-DC, DT12P-DC-BK	DT04-12P*
DT12S-DC	DT06-12S*

## Boots



Boots provide a professional looking finishing touch for DEUTSCH DT family connectors. Made of durable plastisol, these slip-on boots are not only aesthetically appealing, but also provide increased protection from dirt, paint overspray, and pressure washing. The plastisol boots are rated from -20° F to +212° F and offer a slip-on design making installation quick and easy.



Receptacle Boot Description	Boot Part Number		
	DT Series	DTM Series	DTP Series
2 way receptacle boot, gray	DT2P-BT	DTM2P-BT	DTP2P-BT
2 way receptacle boot, black	DT2P-BT-BK	DTM2P-BT-BK	DTP2P-BT-BK
3 way receptacle boot, gray	DT3P-BT	DTM3P-BT	-
3 way receptacle boot, black	DT3P-BT-BK	DTM3P-BT-BK	-
4 way receptacle boot, gray	DT4P-BT	DTM4P-BT	DTP4P-BT
4 way receptacle boot, gray, enhanced length	-	-	DTP4P-BT-EN
6 way receptacle boot, gray	DT6P-BT	DTM6P-BT	-
6 way receptacle boot, black	DT6P-BT-BK	-	-
8 way receptacle boot, gray	DT8P-BT	DTM8P-BT	-
8 way receptacle boot, black	DT8P-BT-BK	DTM8P-BT-BK	-
12 way receptacle boot, gray	DT12P-BT	DTM12P-BT	-
12 way receptacle boot, black	DT12P-BT-BK	DTM12P-BT-BK	-
12 way receptacle boot, gray, enhanced length	DT12P-BT-EN	-	-

\*Distorting the boots can lessen their longevity



Plug Boot Description	Boot Part Number		
	DT Series	DTM Series	DTP Series
2 way plug boot, gray	DT2S-BT	DTM2S-BT	DTP2S-BT
2 way plug boot, black	DT2S-BT-BK	DTM2S-BT-BK	-
3 way plug boot, gray	DT3S-BT	DTM3S-BT	-
3 way plug boot, black	DT3S-BT-BK	DTM3S-BT-BK	-
4 way plug boot, gray	DT4S-BT	DTM4S-BT	DTP4S-BT
4 way plug boot, gray, enhanced length	-	-	DTP4S-BT-EN
6 way plug boot, gray	DT6S-BT	DTM6S-BT	-
6 way plug boot, black	DT6S-BT-BK	-	-
8 way plug boot, gray	DT8S-BT	DTM8S-BT	-
8 way plug boot, black	DT8S-BT-BK	DTM8S-BT-BK	-
12 way plug boot, gray	DT12S-BT	DTM12S-BT	-
12 way plug boot, black	DT12S-BT-BK	DTM12S-BT-BK	-
12 way plug boot, gray, enhanced length	DT12S-BT-EN	-	-
48 way plug boot, gray	DT48S-BT	-	-

\*Distorting the boots can lessen their longevity

## ■ Backshells

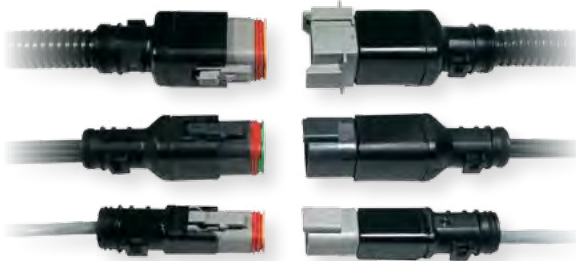

The DEUTSCH DT and DTM Series backshells are designed to snap onto and mate with all standard (basic plug and receptacles without modifications that affect the rear of the connector) DT and DTM Series connectors. The rigid, durable backshells offer a high level of protection and allow convoluted tubing to nest within the rear of the backshell. Straight (180°) and right angle (90°) versions and backshells with strain relief for jacketed cable are also available.

Since the backshells are designed to work with the standard DT and DTM connectors, tests should be conducted for fit and function of a backshell being used on any part with a modification.

### Receptacle Backshells

Connector	Style	Strain Relief	Tubing Size (mm)	P/N
DT04-2P	180°		6, 7.5, 8.5, and 10	1011-229-0205
	180°	X	6, 7.5, 8.5, and 10	1011-257-0205
	90°		6, 7.5, 8.5, and 10	1011-230-0205
	90°	X	6, 7.5, 8.5, and 10	1011-258-0205
DTM*04-2P	180°		7.5 and 8.5	1028-021-0205
DT04-3P	180°		6, 7.5, 8.5, and 10	1011-233-0305
	180°	X	6, 7.5, 8.5, and 10	1011-261-0305
	90°		6, 7.5, 8.5, and 10	1011-234-0305
	90°	X	6, 7.5, 8.5, and 10	1011-262-0305
DT04-4P	180°		6, 7.5, 8.5, and 10	1011-237-0405
	180°	X	6, 7.5, 8.5, and 10	1011-265-0405
	90°		6, 7.5, 8.5, and 10	1011-238-0405
	90°	X	6, 7.5, 8.5, and 10	1011-266-0405
DTM*04-4P	180°		8.5	1028-027-0405
DT04-6P	180°		8.5, 10, and 13	1011-241-0605
	180°	X	8.5, 10, and 13	1011-269-0605
	90°		8.5, 10, and 13	1011-242-0605
	90°	X	8.5, 10, and 13	1011-270-0605
DT04-08P*	180°		8.5, 10, and 13	1011-245-0805
	90°		8.5, 10, and 13	1011-246-0805
DT04-12P*	180°		10, 13, and 17	1011-249-1205
	90°		10, 13, and 17	1011-250-1205

## Plug Backshells

Connector	Style	Strain Relief	Tubing Size (mm)	P/N
DT06-2S	180°		6, 7.5, 8.5, and 10	1011-227-0205
	180°	X	6, 7.5, 8.5, and 10	1011-255-0205
	90°		6, 7.5, 8.5, and 10	1011-228-0205
	90°	X	6, 7.5, 8.5, and 10	1011-256-0205
DTM06-2S	180°		7.5 and 8.5	1011-273-0205
DTM*06-2S	180°		8.5	1028-041-0205
DT06-3S	180°		6, 7.5, 8.5, and 10	1011-231-0305
	180°	X	6, 7.5, 8.5, and 10	1011-259-0305
	90°		6, 7.5, 8.5, and 10	1011-232-0305
	90°	X	6, 7.5, 8.5, and 10	1011-260-0305
DT06-4S	180°		6, 7.5, 8.5, and 10	1011-235-0405
	180°	X	6, 7.5, 8.5, and 10	1011-263-0405
	90°		6, 7.5, 8.5, and 10	1011-236-0405
	90°	X	6, 7.5, 8.5, and 10	1011-264-0405
DTM*06-4S	180°		8.5	1028-008-0405
DT06-6S	180°		8.5, 10, and 13	1011-239-0605
	180°	X	8.5, 10, and 13	1011-267-0605
	90°		8.5, 10, and 13	1011-240-0605
	90°	X	8.5, 10, and 13	1011-268-0605
DT06-08S*	180°		8.5, 10, and 13	1011-243-0805
	90°		8.5, 10, and 13	1011-244-0805
DT06-12S*	180°		10, 13, and 17	1011-247-1205
	90°		10, 13, and 17	1011-248-1205
DT06-12S*-*-*-*	180°		13 and 17	1028-043-1205

## ■ Pull Off Strength



Connector	$F_P$ [N]	$F_T$ [N]
DT04-2P / DT06-2S	50 / 50	50 / 10
DT04-3P / DT06-3S	50 / 50	50 / 50
DT04-4P / DT06-4S	50 / 50	50 / 25
DT04-6P / DT06-6S	50 / 50	50 / 30
DT04-08P* / DT06-08S*	50 / 50	50 / 35
DT04-12P* / DT06-12S*	50 / 50	50 / 40

# DT Family

## ■ Mounting Clips

Mounting clips are used to mount DT Series connectors. To meet design needs, the clips are available for several configurations and in plastic, stainless steel, or steel with zinc plating.

Mounting Clip	Part Number	Used On (Receptacles)	Mounting Direction	Color/Material	Hole O.D. inches (mm)
	1027-003-1200	DT 2, 3, 4, 6, 12 DTM, DTP (all)	Straight	Stainless steel	.433 (11.0)
	1027-005-1200	DT 2, 3, 4, 6, 12 DTM, DTP (all)	Straight	Stainless steel	.512 (13.0)
	1027-004-1200	DT 2, 3, 4, 6, 12 DTM, DTP (all)	Straight	Steel w/ zinc plating	.512 (13.0)
	1027-008-1200	DT 2, 3, 4, 6, 12 DTM, DTP (all)	Side	Steel w/ zinc plating	.433 (11.0)
	1027-013-1200	DT 2, 3, 4, 6, 12 DTM, DTP (all)	Side	Steel w/ zinc plating	.323 (8.2)
	1027-001-0800	DT 8 cavity only	Straight	Stainless steel	.433 (11.0)
	1027-006-0800	DT 8 cavity only	Straight	Stainless steel	.512 (13.0)
	1027-002-0800	DT 8 cavity only	Straight	Steel w/ zinc plating	.512 (13.0)
	1027-014-0800	DT 8 cavity only	Straight	Steel w/ zinc plating	.323 (8.2)
	1011-026-0205	DT 2, 3, 4, 6, 12 DTM, DTP (all)	Straight	Gray plastic	.200 (5.08)
	1011-030-0205	DT 2, 3, 4, 6, 12 DTM, DTP (all)	Straight	Black plastic	---
	1011-310-0205* *Connector removeable with 50N of force	DT 2, 3, 4, 6, 12 DTM, DTP (all)	Straight	Black plastic	---
	1011-027-0805	DT 8 cavity only	Straight	Gray plastic	.200 (5.08)



## DT Family Printed Circuit Board Connectors

The DT Family offers printed circuit board (PCB) connectors that are heavy duty environmentally sealed connectors designed for wire-to-circuit board connections. Available in a variety of styles for the DT, DTM, and DTP connector series, DEUTSCH PCB connectors cover a range of pin counts from 2 to 48 and wire gauges from 10 to 22. Many of the connectors are available in straight or 90° pin options.

### PCB Part Numbering System

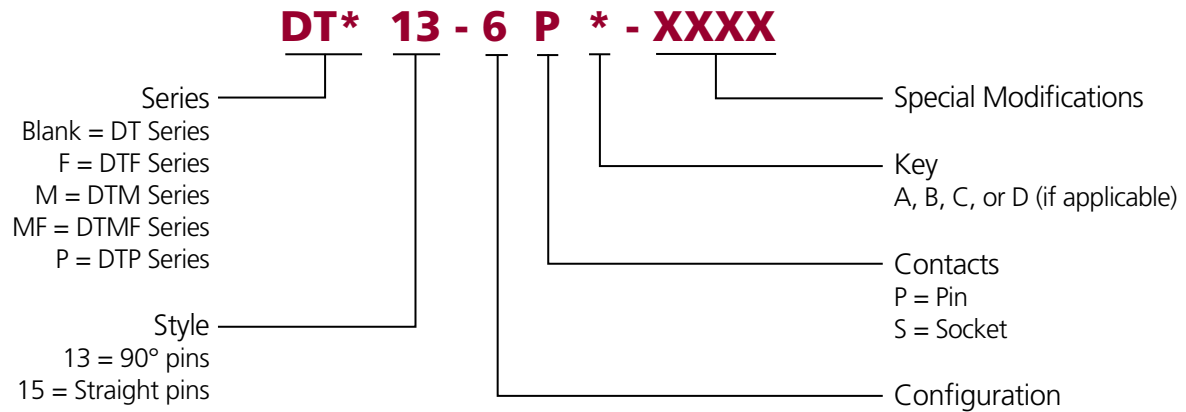

### DT Family PCB Configurations

Connector Description	Pin/Flange Style			
	90° Flange	Straight Flange	90° Flangeless	Straight Flangeless
2 way receptacle, DT Series	DT13-2P	DT15-2P	DTF13-2P	-
3 way receptacle, DT Series	-	-	DTF13-3P	-
4 way receptacle, DT Series	DT13-4P	DT15-4P	DTF13-4P	-
4 way receptacle, DTP Series	DTP13-4P	DTP15-4P	-	-
6 way receptacle, DT Series	DT13-6P	DT15-6P	DTF13-6P	-
8 way receptacle, DT Series	DT13-08P*	DT15-08P*	-	-
12 way receptacle, DT Series	DT13-12P*	DT15-12P*	DTF13-12P*	DTF15-12P*
12 way receptacle, DTM Series	DTM13-12P*	DTM15-12P*	-	-
48 way receptacle, DTM Series	-	-	-	DTMF15-48P

\* = Keying (A, B, C, or D)



*Notice*

For additional information, please see the PCB section.

## DTV Series Overview

The DEUTSCH DTV Series connectors offer the same time tested reliability and performance as the DT Series, with the added flexibility of an 18 cavity flanged design.



### DTV Series Part Numbering System

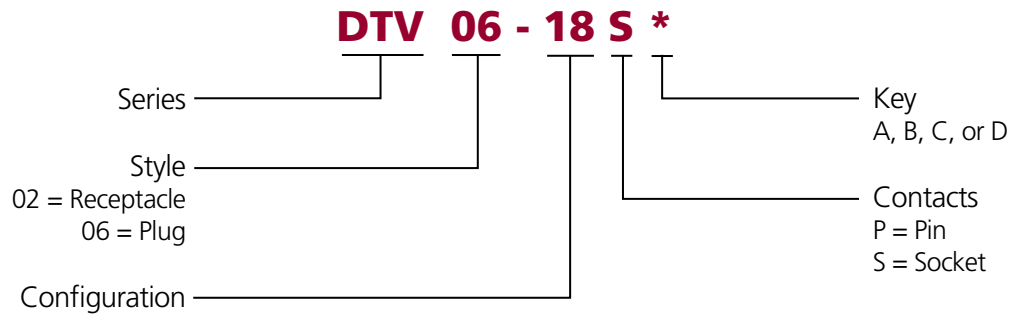

### DTV Series Dimensions

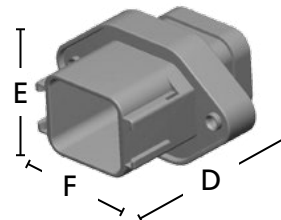
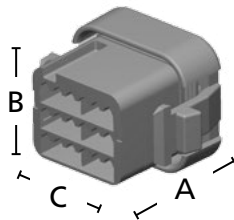

Cavity	DTV Plug			DTV Receptacle		
	Overall Length A	Overall Height B	Overall Width C	Overall Length D	Overall Height E	Overall Width F
18	1.405 (35.69)	1.059 (26.90)	1.450 (36.83)	2.495 (63.37)	1.786 (45.36)	3.194 (81.12)

Dimensions are for reference only.

### Secondary Wedgelocks

#### DTV Series Wedgelocks

Receptacle		
	WV-18P	Wedgelock for 18 way receptacle

Plug		
	WV-18S	Wedgelock for 18 way plug

## DTMH Series & High Temperature Modification Overview

The DTMH Series and DTM Series EE04 modification connectors are environmentally sealed, high temperature connectors capable of operating in temperatures -55° to +150°C. They accept size 20 contacts and carry 7.5 amps each. The DTMH connectors are available in 2-4 cavity arrangements and feature an integrated TPA for easy assembly. The EE04 connectors are available in 6, 8, and 12 cavity arrangements and require a secondary wedgelock.

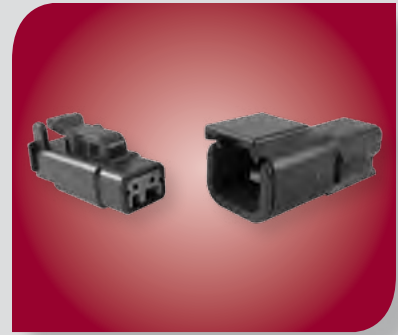

### DTMH Series Part Numbering System

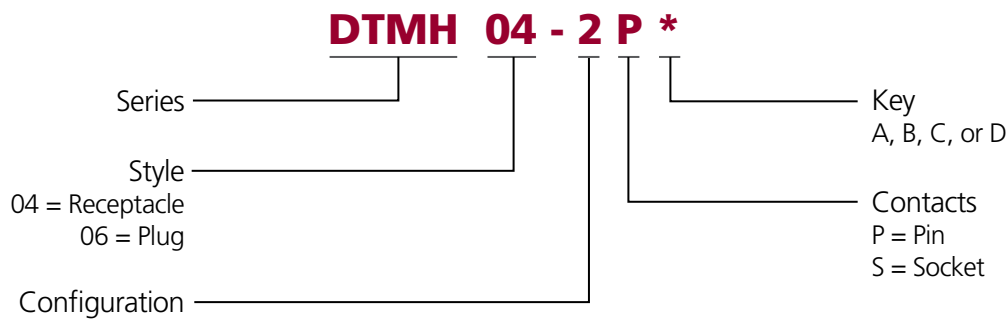

### DTMH Series Configurations

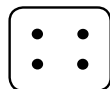
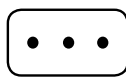
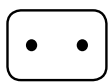

**DTMH0\*-2\*\***    **DTMH0\*-3\*\***    **DTMH0\*-4\*\***  
 2 size 20            3 size 20            4 size 20

### DTMH Series Dimensions

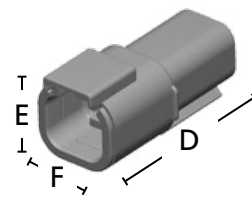
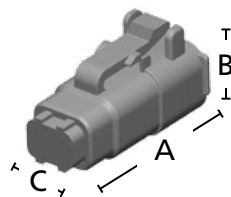

Cavity	DTMH Plug			DTMH Receptacle		
	Overall Length A	Overall Height B	Overall Width C	Overall Length D	Overall Height E	Overall Width F
2	1.085 (27.56)	.508 (12.90)	.555 (14.10)	1.620 (41.15)	.638 (16.21)	.729 (18.52)
3	1.085 (27.56)	.558 (14.17)	.640 (16.26)	1.620 (41.16)	.638 (16.21)	.894 (22.71)
4	1.185 (30.10)	.652 (16.56)	.680 (17.27)	1.720 (43.69)	.772 (19.61)	.834 (21.18)

Dimensions are for reference only.

# DT Family

## DTM Series (EE04 Mod) Part Numbering System

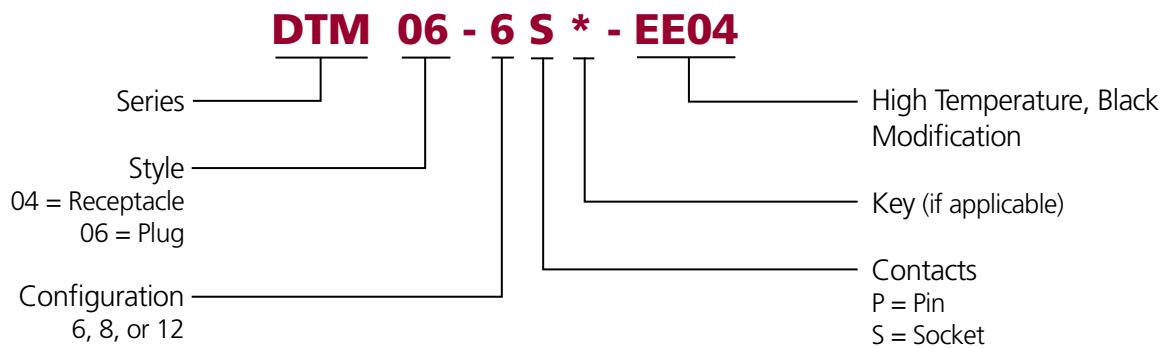

## DTM Series Configurations

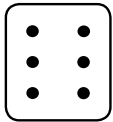

**DTM0\*-6\*-EE04**  
6 size 20

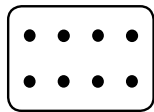

**DTM0\*-08\*\*-EE04**  
8 size 20  
A, B, C, D

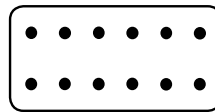

**DTM0\*-12\*\*-EE04**  
12 size 20  
A, B, C, D

## DTM Series Dimensions

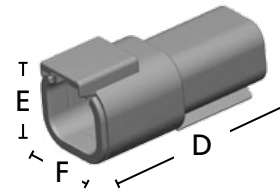
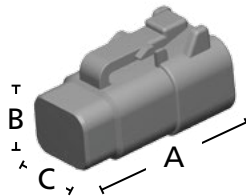

Cavity	DTM Plug			DTM Receptacle		
	Overall Length A	Overall Height B	Overall Width C	Overall Length D	Overall Height E	Overall Width F
6	1.185 (30.10)	.817 (20.75)	.600 (15.24)	1.720 (43.69)	.937 (23.80)	.756 (19.20)
8	1.185 (30.10)	.600 (15.24)	1.245 (31.62)	1.720 (43.69)	.792 (20.12)	1.245 (31.62)
12	1.185 (30.10)	.600 (15.24)	1.575 (40.01)	1.720 (43.69)	.796 (20.22)	1.575 (40.01)

Dimensions are for reference only.

### Notice

DTM EE04 modification connectors require a secondary wedgelock that is sold separately.

## DTMN Series Overview

The DTMN is a non-environmentally sealed connector. The DTMN is available in a 2 or 3 cavity connector and accepts size 20 contacts. The DTMN connector is designed to offer high quality and reliability when a sealed connector is not required.



### DTMN Series Part Numbering System

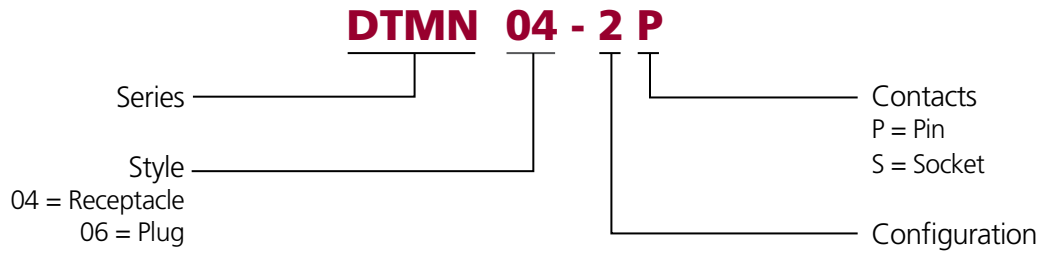

### DTMN Series Configurations



**DTMN0\*-2\*\***    **DTMN0\*-3\*\***  
2 size 20        3 size 20

### DTMN Series Dimensions

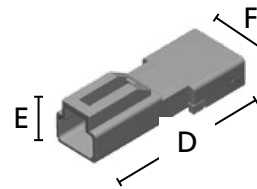
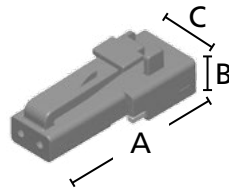

Cavity	DTMN Plug			DTMN Receptacle		
	Overall Length A	Overall Height B	Overall Width C	Overall Length D	Overall Height E	Overall Width F
2	.950 (24.13)	.346 (8.78)	.370 (9.40)	1.198 (30.43)	.334 (8.48)	.444 (11.28)
3	.945 (24.00)	.406 (10.31)	.785 (19.93)	1.188 (30.18)	.400 (10.16)	.810 (20.56)

Dimensions are for reference only.

## How To Instructions

### ■ Contact Insertion



**Step 1:**  
Grasp crimped contact approximately one inch behind the contact barrel.



**Step 2:**  
Hold connector with rear grommet facing you.



**Step 3:**  
Push contact straight into connector grommet until a click is felt. A slight tug will confirm that it is properly locked in place.



**Step 4:**  
Once all contacts are in place, insert green wedge. The green wedge will snap into place.

### ■ Contact Removal



**Step 1:**  
Remove green wedge using needle-nose pliers to pull wedge straight out.



**Step 2:**  
To remove the contacts, gently pull wire backwards, while at the same time releasing the locking finger by moving it away from the contact with a screwdriver.



**Step 3:**  
Hold the rear seal in place, as removing the contact will displace the seal.

### *Notice*

The receptacle is shown, use the same procedure for the plug.

# HD10 Series



## Contents

HD10 Series Overview	62
Part Numbering System	62
Dimensions	62
Connector Styles	63
Configurations	63
Special Modifications	63-64
Accessories	64-67



## HD10 Series Overview

The HD10 Series is an environmentally sealed, thermoplastic cylindrical connector series and offers arrangements from 3 to 9 cavities. All HD10 connectors are available either in-line or flanged and accept size 12 or 16 contacts, or a combination of size 16 and size 4 contacts. The HD10 Series is heavily used for diagnostic connectors, helps reduce assembly issues and maintenance time, and is designed for long service life.



### Part Numbering System

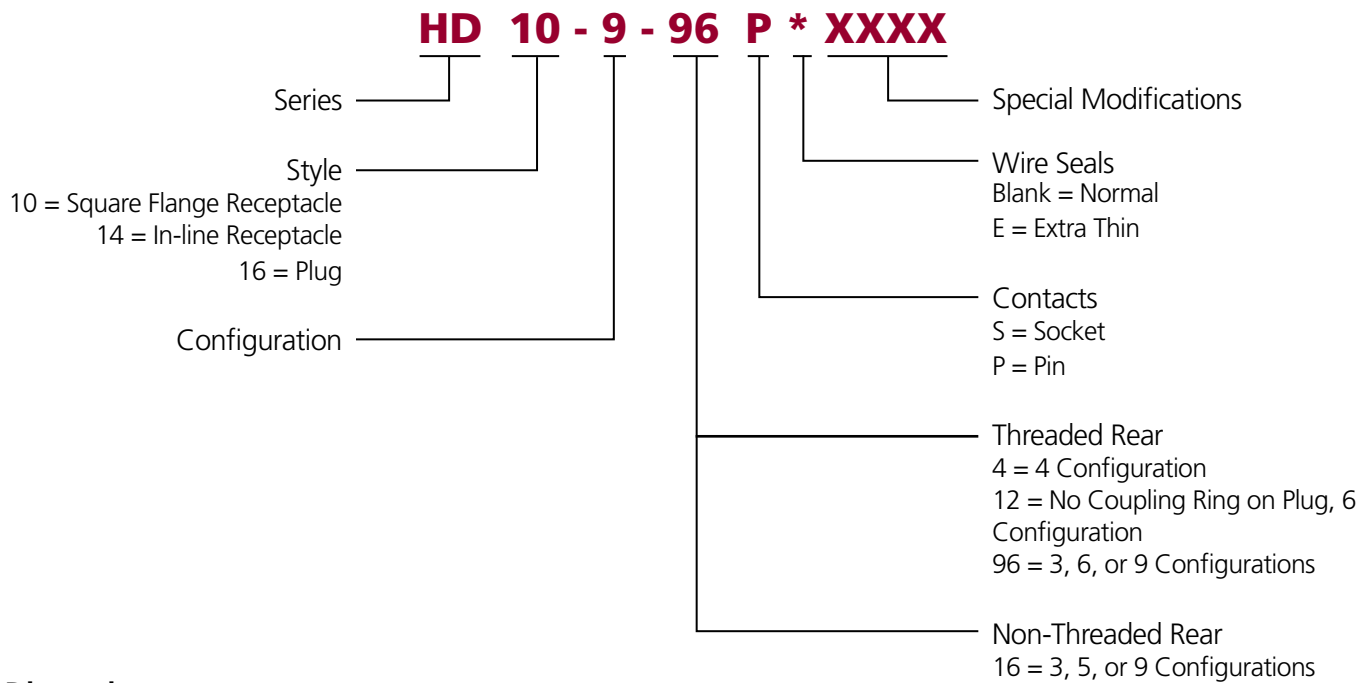

### Dimensions

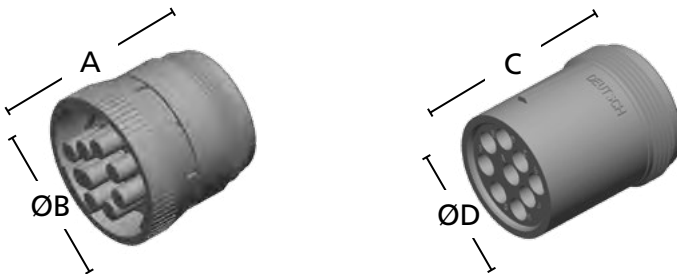

Cavity	HD10 Plug		HD10 Receptacle	
	Overall Length A	Overall Height ØB	Overall Length C	Overall Height ØD
3	1.609 (40.87)	1.069 (27.15)	1.639 (41.63)	.851 (21.62)
4	1.639 (41.63)	1.595 (40.51)	1.639 (41.63)	1.281 (32.54)
5	1.609 (40.87)	1.218 (30.94)	1.639 (41.63)	1.001 (25.43)
6	1.619 (41.12)	1.453 (36.91)	1.639 (41.63)	1.141 (28.98)
9	1.609 (40.87)	1.593 (40.47)	1.639 (41.63)	1.281 (32.54)

Dimensions are for reference only.





## ■ Connector Styles

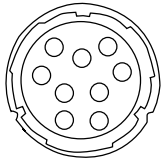

Plug HD16

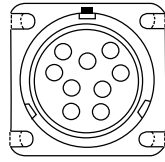

Square Flange Receptacle HD10

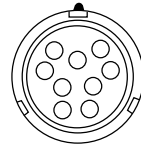

In-line Receptacle HD14

## ■ Configurations

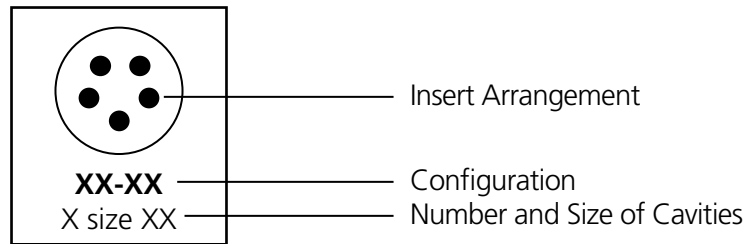

**3-16/3-96\***  
3 size 16

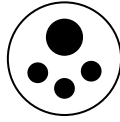

**4-4**  
1 size 4  
3 size 16

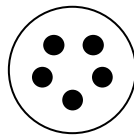

**5-16**  
5 size 16

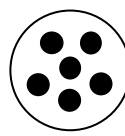

**6-12**  
6 size 12

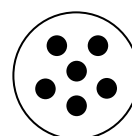

**6-96**  
6 size 16

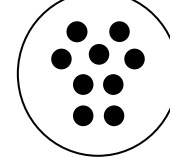

**9-16**  
9 size 16

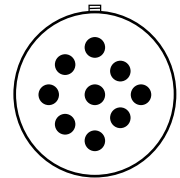

**9-96\***  
9 size 16

\*Also available in an "E" seal

## Special Modifications

The HD10 Series connectors offer several modifications to enhance the design flexibility and meet application specific needs. Options include the addition of a coupling ring and connector body color, just to mention a few. By combining the HD10 Series connectors with the available modifications and accessories, the design possibilities are increased.

### ■ B010 Modification

The B010 modification provides the addition of a coupling ring used for mating. The B010 modification is only available on the HD16-6-12S-B010 connector.



### ■ E004 Modification

The E004 modification changes the HD10 Series connector from the standard gray to a black connector body.



# HD10 Series

## ■ N005 Modification

The N005 modification is an HD10 Series receptacle with molded-in, straight PCB pins.



## ■ J1939 Modifications (BP03, P080)

The P080 modification changes the HD10 Series connector body color from the standard gray to green and meets the J1939 Type II requirements. The BP03 modification is similar to the P080 modification, but features a panel mount.



### Notice

Please see Contacts section for extended PCB pins.

## Accessories

Several accessory items are available to complement the HD10 Series connectors including boots, backshells, gaskets, and protective caps. Accessory items cover a wide array of design requirements such as assisting with mounting, providing additional protection, and offering enhanced aesthetics.

## ■ Backshells



The DEUTSCH HD10 Series backshells are designed to screw onto all threaded HD10 connectors. Rated for temperatures from -40°C to +134°C, the rigid, durable backshells offer a high level of protection, provide strain relief, and improve aesthetics.

### Backshell and Compression Nut Assembly



Connector Part Number	Cable Diameter	Backshell Part Number	Compression Nut Part Number
<b>DEUTSCH HD10 Series 3 Way</b> HD1*-3-96*	.187-.300	M902-2131	M902-2041
	.300-.430	M902-2132	M902-2042
<b>DEUTSCH HD10 Series 6 Way</b> HD1*-6-96* HD1*-6-12*	.187-.300	M902-2161	M902-2041
	.300-.430	M902-2162	M902-2042
	.430-.570	M902-2163	M902-2053
	.570-.710	M902-2164	M902-2054
<b>DEUTSCH HD10 Series 9 Way</b> HD1*-9-96* HD1*-9-1939**	.187-.300	M902-2191	M902-2041
	.300-.430	M902-2192	M902-2042
	.430-.570	M902-2193	M902-2053
	.570-.710	M902-2194	M902-2054

Backshell Technical Specifications:

Material - PC/PET Polyester Blend, UV-Stabilized, Flame Retardant, Black  
Flammability - UL94-VO, Weatherability - UL746C

## Strain Relief

DEUTSCH HD10 Series strain reliefs are designed to screw onto threaded 3, 4, 6, and 9 cavity HD10 connectors. The rigid, durable strain reliefs offer a high level of protection, provide tie wrap holders to reduce the strain from the wires, and improve aesthetics.



Part Number	Description
HD18-003	3 cavity strain relief
HD18-006	6 cavity strain relief
HD18-009	4 or 9 cavity strain relief



*Attaching the connector to a structure eliminates straining the electrical system in service.*



## Protective Dust Caps

The HD10 Series protective dust caps provide an environmental seal and are used to protect the connector interface when the connector is not mated.



### HDC14 Protective Cap for Plug

Part Number	Description
HDC14-3	3 cavity plug protective cap
HDC14-6	6 cavity plug protective cap
HDC14-9	9 cavity plug protective cap

### HDC16 Protective Cap for Receptacle

Part Number	Description
HDC16-3	3 cavity receptacle protective cap
HDC16-5	5 cavity receptacle protective cap
HDC16-6	6 cavity receptacle protective cap
HDC16-6-E004	6 cavity receptacle protective cap, black
HDC16-9	9 cavity receptacle protective cap
HDC16-9-E004	9 cavity receptacle protective cap, black

## Boots



Boots provide a professional looking finishing touch for DEUTSCH HD10 Series connectors. Made of durable plastisol, these slip-on boots are not only aesthetically appealing, but also provide increased protection from dirt, paint overspray, and pressure washing. The plastisol boots are rated from -20° F to +212° F and offer a slip-on design making installation quick and easy.



Part Number	Description
HD10-3BT	3 cavity boot, gray
HD10-5BT	5 cavity boot, gray
HD10-5BT-BK	5 cavity boot, black
HD10-6BT	6 cavity boot, gray
HD10-6BT-BK	6 cavity boot, black
HD10-9BT	9 cavity boot, gray
HD10-9BT-BK	9 cavity boot, black

\*Distorting the boots can lessen their longevity

## Gaskets



Moisture, dirt, salt, sand, and road debris can work their way into electrical panels through unsealed mounting flanges. Rated to operate in environments from -70°F to +225°F, these rugged high quality neoprene gaskets form a tight seal between the panel face and connector flange to help keep out destructive elements. The gaskets have a thickness of .125" and meet the UL-94-HBF, Mil-R-6130C, and FMVSS-302 flammability specifications.



Gasket P/N	Connector P/N
HD10-3-GKT	HD10-3-****
HD10-5-GKT	HD10-5-****
HD10-6-GKT	HD10-6-****
HD10-9-GKT	HD10-9-****

## Lanyards





Lanyards are available in nitrile or nylon coated steel and designed for use with protective dust caps.



HDC9-JDL082397  
(DEUTSCH HDC16-9-E004 dust cap assembled with JDL082397)



HDC16-9-L47N  
(DEUTSCH HDC16-9 dust cap assembled with L47N-600-1)

Lanyard	Material	Material Diameter	Length	Minimum Breaking Strength
 JDL082397	Nitrile o-ring, 3M heat shrink with thermoplastic adhesive	.07 inches	5.31 inches	---
 L47N-600-1	7 x 7 galvanized steel cable coated with clear nylon	.047 inches	6 inches	270 lbs.

Dimensions are for reference only.

## Dust Cap/Lanyard Assemblies

Part Number*	Used On	Connector Cavities	Lanyard Material	Dust Cap Color
HDC14-3-JDL	Plug	3	Nitrile	Gray
HDC14-6-JDL	Plug	6	Nitrile	Gray
HDC14-6-LA	Plug	6	Steel	Gray
HDC14-9-JDL	Plug	9	Nitrile	Gray
HDC16-3-JDL	Receptacle	3	Nitrile	Gray
HDC16-3-LA	Receptacle	3	Steel	Gray
HDC16-5-LA	Receptacle	5	Steel	Gray
HDC16-6-JDL	Receptacle	6	Nitrile	Gray
HDC16-6-LA	Receptacle	6	Steel	Gray
HDC16-9-JDL	Receptacle	9	Nitrile	Gray
HDC9-JDL082397	Receptacle	9	Nitrile	Black
HDC16-9-L47N	Receptacle	9	Steel	Gray
HDC16-9-E004-L47N	Receptacle	9	Steel	Black

\*Other dust cap/lanyard assemblies may be available



# HD30 & HDP20 Series

## Contents

HD30 & HDP20 Series Overview	70
Dimensions	70
Part Numbering System	71
Configurations	72-73
Wire Insulation	73
Special Modifications	73-74
Accessories	75-78

Mounting	78-79
How To Instructions	79-80

# HD30 & HDP20 Series

## HD30 & HDP20 Series Overview

Designed specifically for the truck, bus, and off-highway industry, the HD30 & HDP20 Series are heavy duty, environmentally sealed, multi-pin circular connectors. Available in metal or thermoplastic housings, these connectors offer multiple pin configurations that accept contact sizes 4 through 20.

The HD30 is a metal shell while the HDP20 Series shells are thermoplastic. Both feature quick connect-disconnect bayonet coupling, single hole bulkhead mounting, silicone seals, and a rear insertion/rear removal contact system.

### HD30 Series Overview



The DEUTSCH HD30 Series connectors are constructed from a metal shell developed to meet the needs of the heavy duty equipment and transportation industries. The HD30 features include quick connect-disconnect bayonet coupling, single hole bulkhead mounting, silicone seals, and a rear insertion/rear removal contact system.

### HDP20 Series Overview

The HDP20 Series is a heavy duty rated, environmentally sealed, composite shell, multi-pin connector. The composite thermoplastic shell is ideal in applications where chemicals can damage a connector housing. HDP20 features quick connect-disconnect bayonet coupling, single hole bulkhead mounting, silicone seals, and a rear insertion/rear removal contact system.



### HD30 & HDP20 Series Dimensions

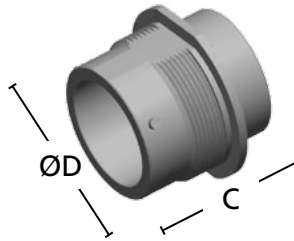
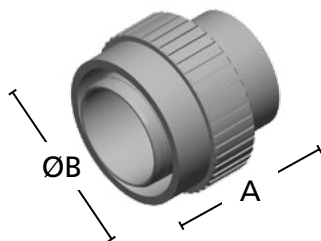

Shell Size	HD/HDP Plug		HD/HDP Receptacle	
	Overall Length A	Overall Height ØB	Overall Length C	Overall Height ØD
18	1.521 (38.63)	1.700 (43.17)	1.648 (41.86)	1.750 (44.45)
24	1.521 (38.63)	1.950 (49.53)	1.648 (41.86)	2.000 (50.80)

Dimensions are for reference only.



## HD30 Series Part Numbering System

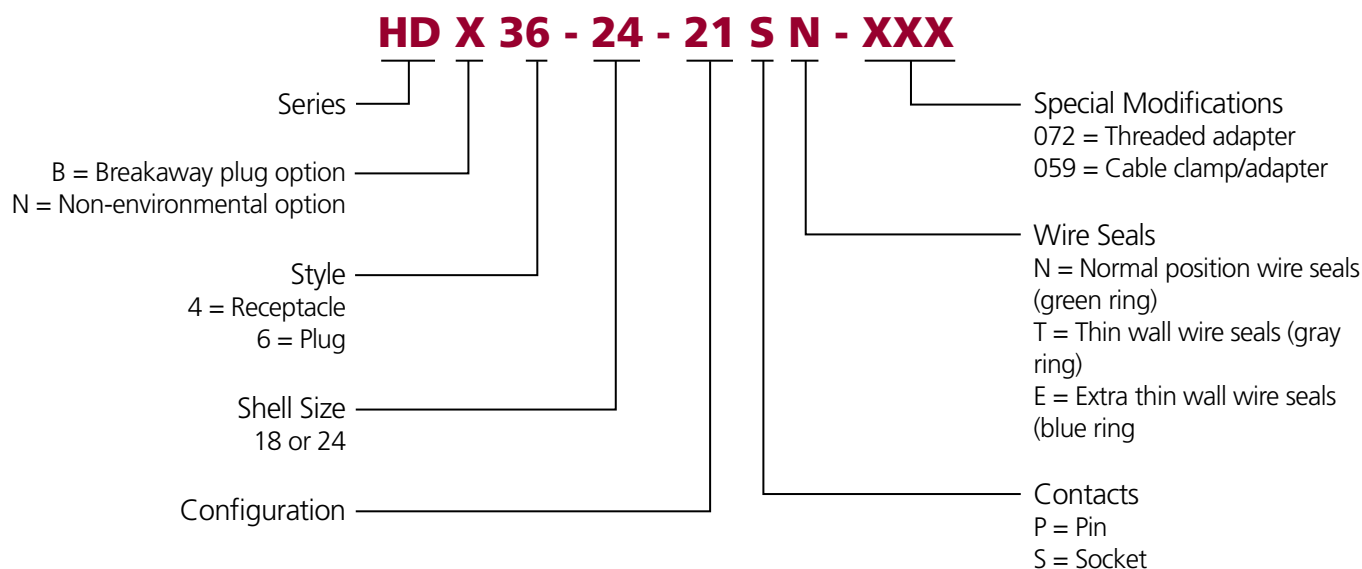

**Notice**

Reverse arrangements are available as a keying option for the HD30 & HDP20 Series.

## HDP20 Series Part Numbering System

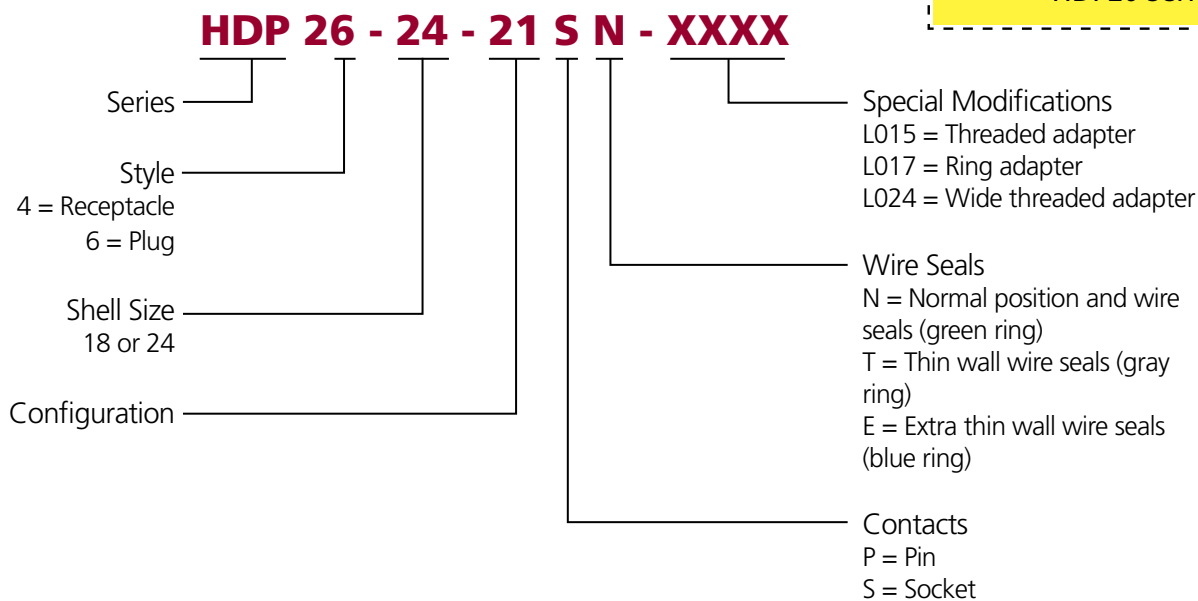

Making the socket contact side the "hot side" can reduce the danger of electric shock.

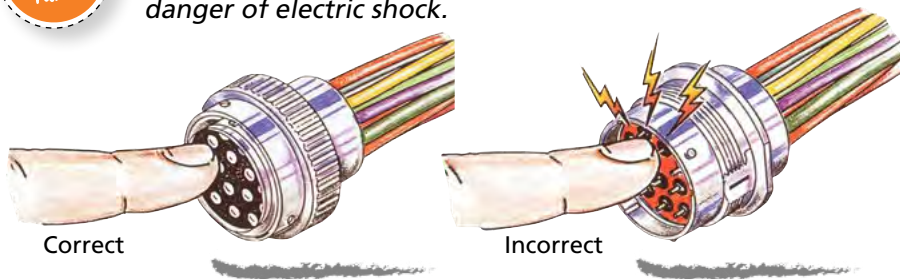

# HD30 & HDP20 Series

## HD30 & HDP20 Series Configurations

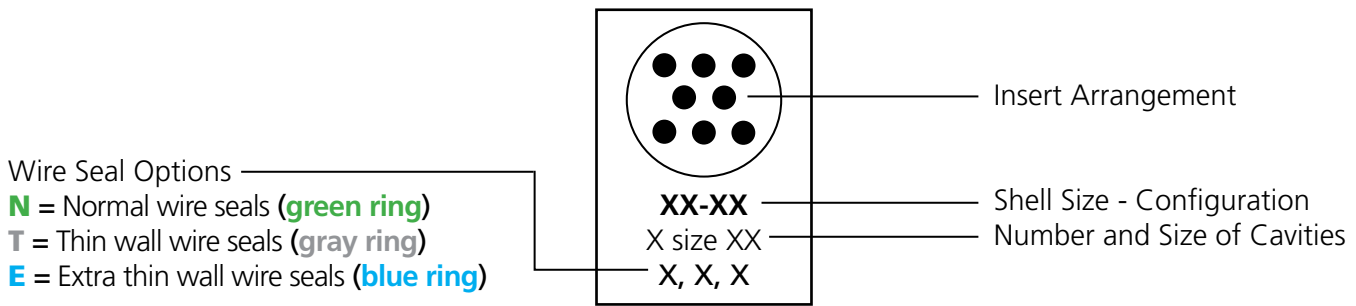

### 18 Shell Size Configurations

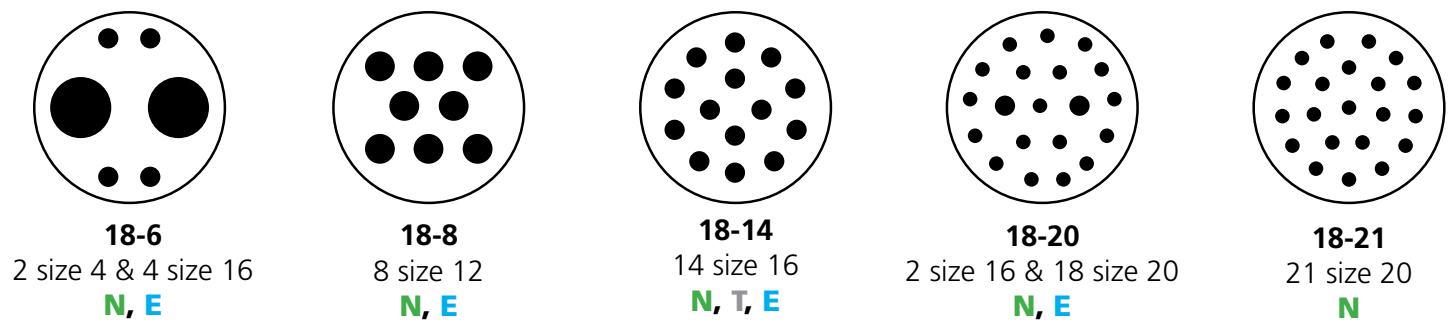

### 24 Shell Size Configurations

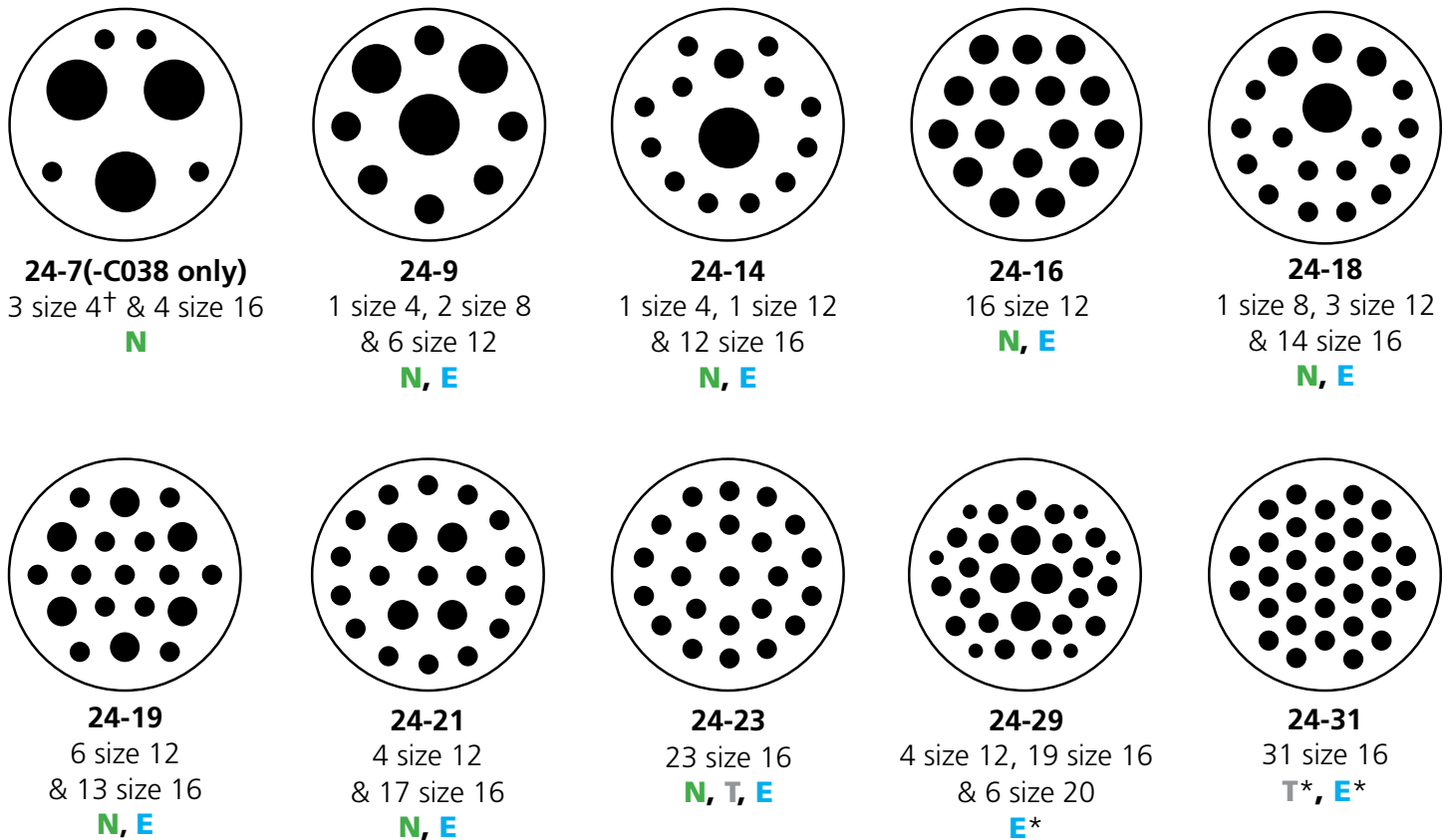

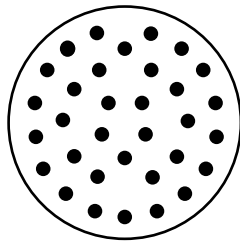

**24-33**  
33 size 20  
**N**

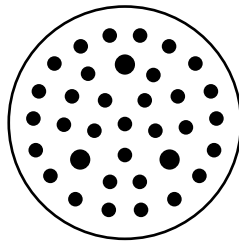

**24-35**  
3 size 16 & 32 size 20  
**N, E**

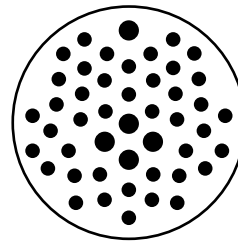

**24-47**  
5 size 16 & 42 size 20  
**E\***

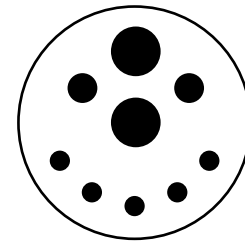

**24-91-P064‡**  
2 size 8, 2 size 12  
& 5 size 16  
**N, E**

\*Modified seal, see drawing

‡Without P064 modification, plug cavities 4 and 5 are internally connected

## ■ Wire Insulation

Contact Size	Recommended Wire Insulation O.D.		
	N Seal Green Ring	T Seal Gray Ring	E Seal Blue Ring
20	.040-.095 (1.02-2.41)	.040-.095 (1.02-2.41)	.040-.095 (1.02-2.41)
16	.100-.134 (2.54-3.40)	.088-.134 (2.23-3.40)	.053-.120 (1.35-3.05)
12	.134-.170 (3.40-4.32)	.113-.170 (2.87-4.32)	.097-.158 (2.46-4.01)
8	.190-.240 (4.83-6.10)	.170-.240 (4.32-6.10)	.135-.220 (3.43-5.59)
4	.280-.292 (7.11-7.42)	.261-.292 (6.63-7.42)	.261-.292 (6.63-7.42)

*Notice*

Undersized wire insulation is a major cause for leakage.

Color code is visible from the rear of the receptacle or plug.

**Green:** Normal Seal  
**Gray:** Thin Wall Seal  
**Blue:** Extra Thin Seal



Color Coded Ring

## Special Modifications

The HD30 & HDP20 Series connectors offer several modifications to enhance design flexibility and meet application specific needs. Options include breakaway plugs, adapters, and high amperage options just to mention a few. By combining the HD30 & HDP20 Series connectors with the available modifications and accessories, the design possibilities are greatly expanded.

### ■ HDB - Breakaway Plug (HD30 Series Only)



The HDB is designed to provide an emergency disconnect between farm tractors and implements that require power connections. The HDB breakaway plug is designed to break the connection before damaging the wiring system. These plugs can be specified with pin or socket contacts and connect only with the HD30 Series receptacles. As an added design convenience, the HDB is also available with an optional cable clamp (059 mod). Breakaway function occurs at an axial load of 50-100 lbs.

# HD30 & HDP20 Series

## L015/L017/L024 Modifications

The L015/L024 threaded adapters and L017 ring adapter modifications are available for the DEUTSCH HDP20 Series. These adapter modifications provide simple, low cost assembly solutions for applications that require a backshell or conduit. The modifications must be ordered with the initial connector, as it is factory assembled. The adapters are designed to be used with the backshell of your choice.

- The L015 threaded adapter is available on size 24 shells in the HDP20 Series.
- The L017 ring adapter is available on size 24 or size 18 shells in the HDP20 Series.
- The L024 wide threaded adapter is available on size 24 or size 18 shells in the HDP20 Series.



L015  
Threaded Adapter

L017  
Ring Adapter



L024  
Wide Threaded Adapter

## C030 Modification



Originally designed for multiplexing and battery cable applications, the DEUTSCH C030 modification is an environmentally sealed, heavy duty two cavity connector that accepts size 4 solid contacts rated up to 100 amps for each cavity.

The C030 modification is available in size 18 shell in both metal (HD30 Series) and thermoplastic (HDP20 Series) to meet your heavy wire gauge application needs.

## Cable Clamp/Backshell Modifications

DEUTSCH cable clamps provide positive support to the wire bundle while reducing strain on the connector. The backshell is available with or without drain holes.



Part Number Suffix	Description
-072	Adapter only
-059	Adapter and cable clamp assembly with drain holes
-L006	Adapter and cable clamp assembly without drain holes

## Accessories

Several accessory items can be used to complement the connectors. The HD30 & HDP20 family accessories include items such as boots, backshells, gaskets, and protective caps. Accessories are designed to complete the application and meet a wide array of design requirements such as solutions for mounting, providing additional protection, and offering increased aesthetics.

### Boots



Boots provide a professional looking finishing touch for the DEUTSCH HD30 & HDP20 family of connectors. Made of durable plastisol, these slip-on boots are not only aesthetically appealing, but also provide increased protection from dirt, paint overspray, and pressure washing. The plastisol boots are rated from -20° F to +212° F and offer a slip-on design making installation quick and easy.



Part Number	Description
HD30-18BT	18 shell size boot, gray
HD30-18BT-BK	18 shell size boot, black
HD30-18BT-90-BK	18 shell size boot, 90° bend, black
LC-90BT-HT	18 shell size boot, 90° bend, high temperature material, yellow
HD30-24BT	24 shell size boot, gray
HD30-24BT-BK	24 shell size boot, black
HD30-24BT-90-BK	24 shell size boot, 90° bend, black
MT-90BT-HT-24	24 shell size boot, 90° bend, high temperature material, yellow

\*Distorting the boots can lessen their longevity

### Protective Dust Caps

Protective caps are available for both plug and receptacle halves of the connectors. The metal caps, for use with the HD30 Series, come with a mounting chain and are used to protect the connector while not mated. The thermoplastic caps, for use with the HDP20 Series, are available with or without a lanyard.



#### HDP20 Series Dust Caps

Shell Size	Part Number	Description
18	HDC26-18	Plug cap for receptacle protection, environmentally sealed
24	HDC26-24	

#### HD30 Series Dust Caps

Shell Size	Part Number*	Description
18	HDC36-18	Plug cap for receptacle protection
24	HDC36-24	
18	HDC34-18	Receptacle cap for plug protection
24	HDC34-24	

\*To order HD30(HD3\*-\*\*) protective caps without the mounting chain, add -1E to the end of the part number

# HD30 & HDP20 Series

## Strain Relief

The DEUTSCH HD30 & HDP20 Series offers several backshell options to meet your design needs. Backshell options include straight or 90° and plastic or metal. The metal backshells work best with the HD30 Series. It is attached to the rear of the connector using an adjustable screw and is secured to the wire bundle with the use of a tie wrap. The plastic backshells work best with the HDP20 Series and attach to the rear of the connector with either a clamshell snap closure or by screwing them on to a threaded adapter. The rigid, durable backshells offer a high level of protection, provide strain relief, and improve aesthetics.



### HD30 Series Backshell

Shell Size	Orientation	Part Number
18	Straight	WHDS-18-1
24		WHDS-24-1
18	90°	WHDS-18-2
24		WHDS-24-2



### HDP20 Series L017 Backshell

Shell Size	Orientation	Part Number	Conduit Size
18	Straight	2428-016-1805	13, 17, 19 (mm) NW
	90°	2428-015-1805	13, 17, 19 (mm) NW
24	Straight	2428-008-2405	1"
	90°	2428-004-2405	1"
24	Straight	2428-010-2405	17, 19, 23, 26 (mm) NW
	90°	2428-011-2405	17, 19, 23, 26 (mm) NW

NW = Nominal Width of the conduit's inside diameter. See drawings for full specifications.



Seal Ring

Cap Nut

### HDP20 Series L015 Conduit Adapter

Shell Size	L015 Conduit Adapter Part Numbers		Conduit Size
24	Seal Ring: SRN21	Cap Nut: CN21	22 (mm) NW

## Backshells for L015 Modification



The DEUTSCH HDP20 Series backshells are designed to screw onto connectors with the L015 modification, which adds a threaded adapter. Rated for temperatures from -40°C to +134°C, the rigid, durable backshells offer a high level of protection, provide strain relief, and improve aesthetics.

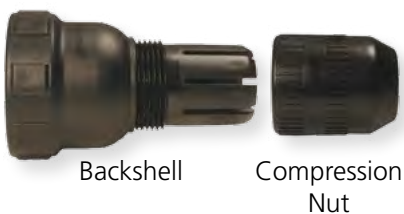

Backshell

Compression Nut

### HDP20 Series L015 Backshell

Shell Size	Cable Diameter	Backshell	Compression Nut
24	.430-.570	M902-2243	M902-2053
	.570-.710	M902-2244	M902-2054

Backshell Technical Specifications:

Material - PC/PET Polyester Blend, UV-Stabilized, Flame Retardant, Black  
 Flammability - UL94-VO, Weatherability - UL746C

## Backshells for L024 Modification

The DEUTSCH HDP20 Series backshells are designed to screw onto connectors with the L024 modification, which adds a wide threaded adapter. The rigid, durable backshells offer a high level of protection, provide strain relief, and improve aesthetics.



### HDP20 Series L024 Backshell



Shell Size	Orientation	Part Number
18	Straight	2428-025-1805
24	Straight	2428-024-2405

## Gaskets



Moisture, dirt, salt, sand, and road debris can all work their way into electrical panels through unsealed mounting flanges. Rated to operate in environments from -70°F to +225°F, these rugged high quality neoprene gaskets form a tight seal between the panel face and connector flange to help keep out destructive elements. The gaskets have a thickness of .125" and meet the UL-94-HBF, Mil-R-6130C, and FMVSS-302 flammability specifications.



	
16-04978 (18 Shell Size Receptacle)	16-04477 (24 Shell Size Receptacle)

## Mounting Hardware

DEUTSCH lockwashers and panel nuts are available to aid in mounting the HD30 and HDP20 Series connectors. The lockwashers are used to add tension between the threads and the nut to provide a secure mount. The lockwasher and the panel nut should be used together.

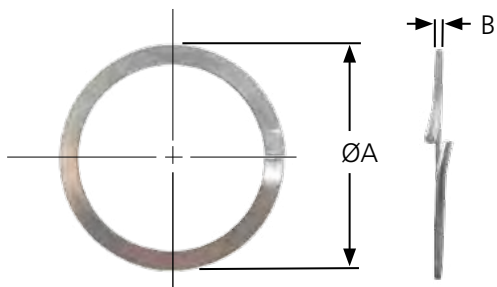

### Panel Lockwasher

Shell Size	Series	Part Number	ØA	B
18	HDP20	2414-002-1886	1.892 (48.06)	-
	HD30	114021	1.699 (43.15)	.062 (1.57)
24	HDP20	2414-001-2486	2.080 (52.83)	-
	HD30	112264	1.887 (47.93)	.062 (1.57)

Dimensions are for reference only.

# HD30 & HDP20 Series

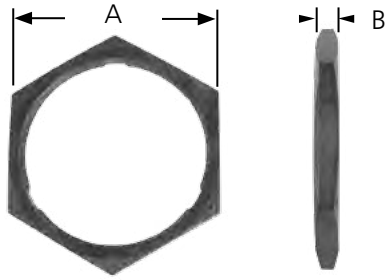

## Panel Nut Mounting Torque

HD30 18 Shell Size	260-280 IN. LB. (29.4-31.6 N.M.)
HDP20 18 Shell Size	45-55 IN. LB. (5.1-6.1 N.M.)
HD30 24 Shell Size	350-375 IN. LB. (39.5-42.6 N.M.)
HDP20 24 Shell Size	65-75 IN. LB. (7.4-8.4 N.M.)

## Panel Nut

Shell Size	Series	Part Number	Material	A	B
18	HDP20	2411-002-1805	Plastic	1.685 (42.80)	.250 (6.35)
	HD30	114020-90	Metal		.178 (4.52)
24	HDP20	2411-001-2405	Plastic	1.875 (47.63)	.250 (6.35)
	HD30	112263-90	Metal		.178 (4.52)

Dimensions are for reference only.

## Mounting

### Receptacle Mounting

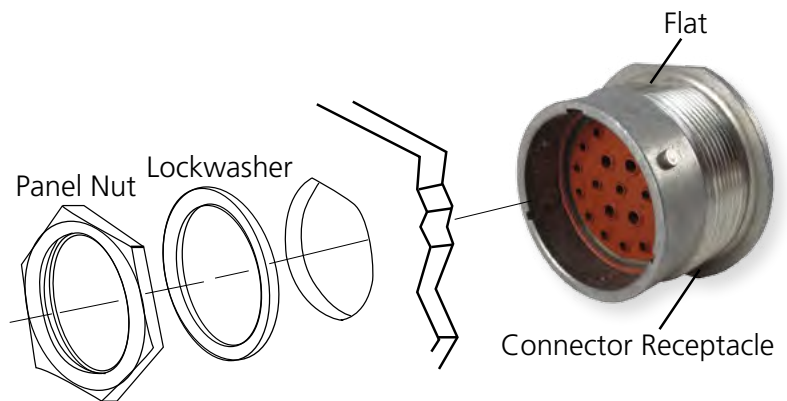
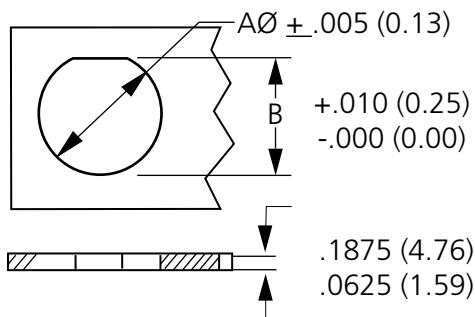

### Recommended Size of Mounting Hole

Shell Size	AØ	B
18	1.507 (38.28)	1.442 (36.63)
24	1.696 (43.08)	1.632 (41.45)



Mounting connectors horizontally allows proper water drainage.

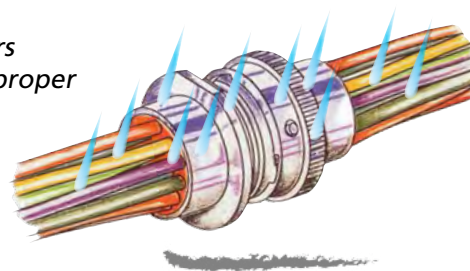



## D Hole Punch



The D hole punch is a hand tool used to cut a D shaped hole. The D shaped hole allows the connector to be securely mounted and prevents the connector from spinning.

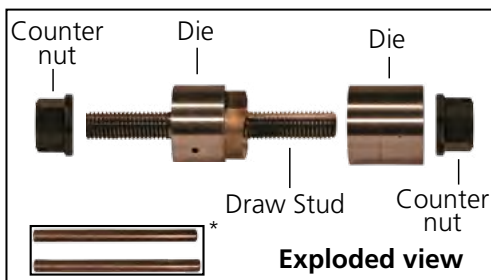

\*The rods included with the "D" hole punch are used to remove the cutout and are not used in the cutting process.

### Punchable Material:

Up to .078" mild steel or aluminum. Up to .1875" plastic, wood, paneling, or other soft material.

### Tool Material:

A2 material heat treated to a Rockwell hardness of 60 to 62.

### Tool Size: (rough dimensions)

5.5" L x 2" H x 2" D

### Sharpening:

The tool can be sharpened as needed.

### Usability:

A .625" minimum pilot hole is required to accommodate the draw stud. Air tools can be used.

Shell Size	Part Number
18	18-D-PUNCH
24	24-D-PUNCH

## How To Instructions

### Mating Instructions

To mate the plug and the receptacle, line up the index groove on the plug with the flat surface on the receptacle, turn 1/4 turn clockwise. You will feel and hear the pieces snap into the locked position. To unmate the plug and receptacle, release the coupling ring by turning it counter-clockwise.

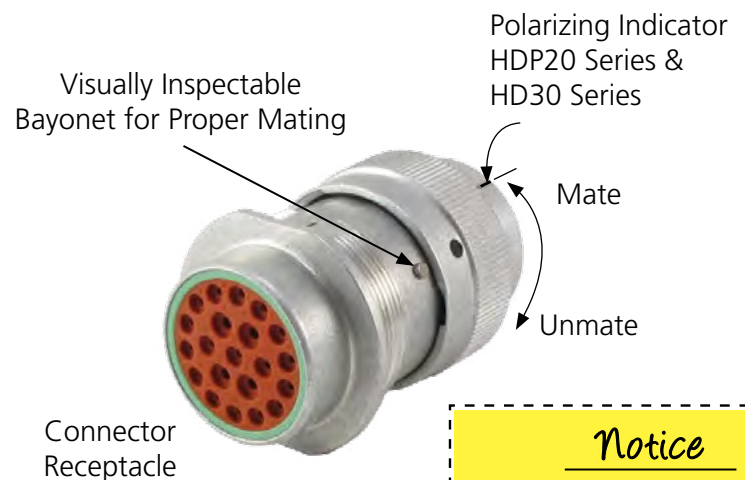

**Notice**  
When mating or unmating connectors, disassemble by hand. Do not use pliers or any other tool.

## ■ Contact Insertion

---



**Step 1:**  
Grasp contact approximately one inch behind the contact crimp barrel.

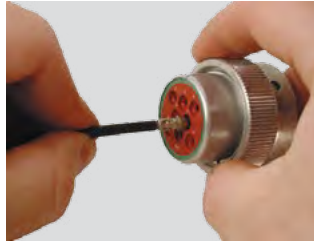

**Step 2:**  
Hold connector with rear grommet facing you.

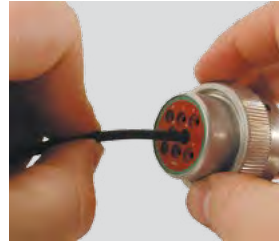

**Step 3:**  
Push contact straight into connector grommet until a positive stop is felt. A slight tug will confirm that it is properly locked in place.

## ■ Contact Removal

---

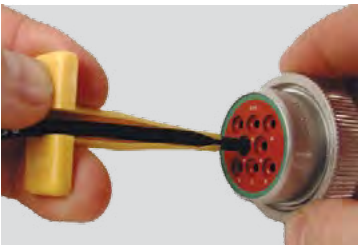

**Step 1:**  
With rear insert toward you, snap appropriate size removal tool over the wire of contact to be removed.

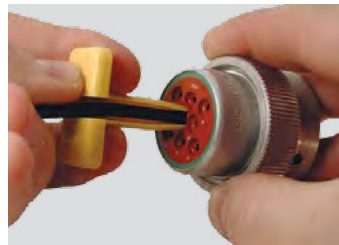

**Step 2:**  
Slide tool along the wire into the insert cavity until it engages contact and resistance is felt.

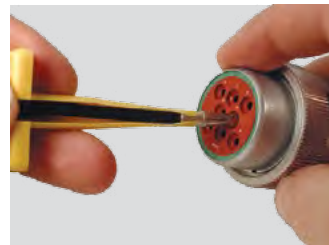

**Step 3:**  
Pull contact wire assembly out of connector.

### *Notice*

Do not twist or insert tool at an angle.

# STRIKE Series



## Contents

STRIKE Series Connector Overview	82
Part Numbering System	82
Dimensions	82
Configurations	83
Accessories	83
How To Instructions	84

## STRIKE Series Connector Overview

The STRIKE connector series features a lever lock system and is designed for heavy duty equipment applications. The environmentally sealed series offers two different size rugged housings that accept contacts from size 20 to 16 with arrangements of 32 and 64 cavities. The lever lock combined with varying cavity arrangements allows the STRIKE Series connectors to offer flexible options for electrical designs.



### Part Numbering System

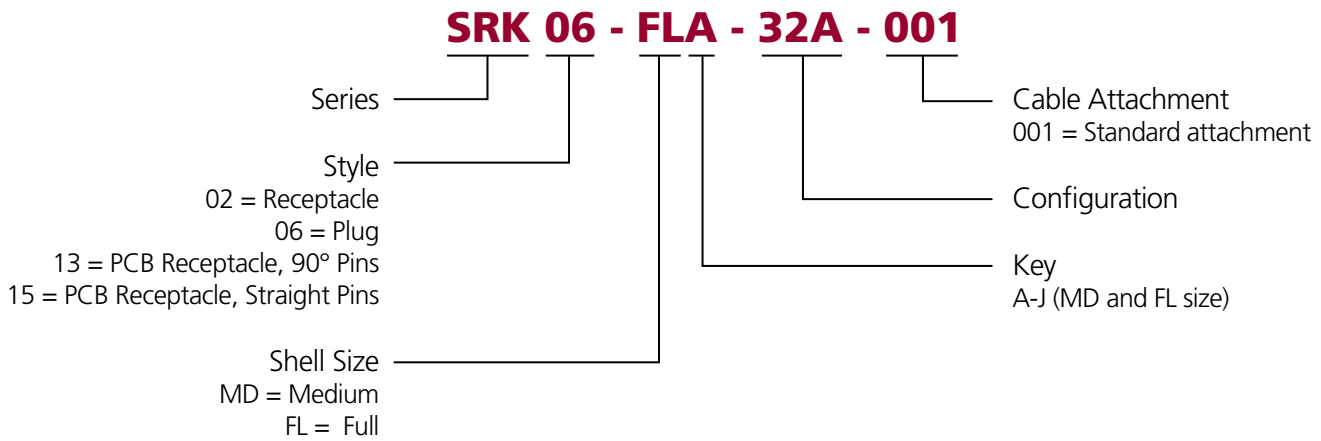

### Dimensions

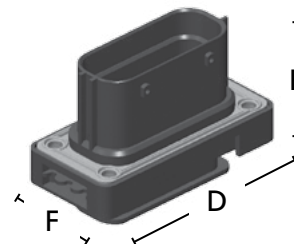
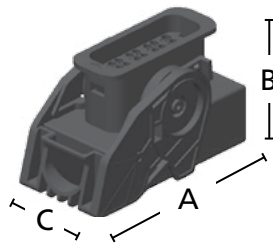

Shell Size	STRIKE Plug			STRIKE Receptacle		
	Overall Length A	Overall Height B	Overall Width C	Overall Length D	Overall Height E	Overall Width F
MD	3.189 (81.00)	1.909 (48.50)	1.531 (38.90)	3.228 (82.00)	2.205 (56.00)	1.575 (40.00)
FL	3.358 (85.28)	1.913 (48.60)	2.780 (70.60)	3.228 (82.00)	2.205 (56.00)	2.953 (75.00)

Dimensions are for reference only.

■ Configuration

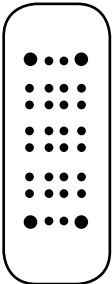
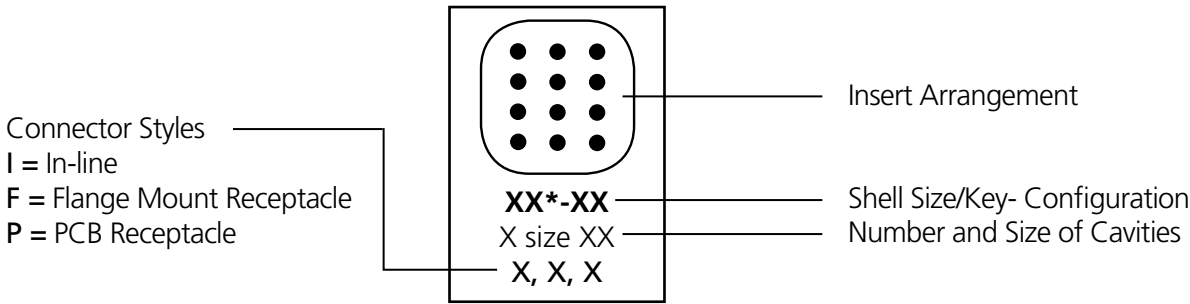

**MD\*-32A**  
 4 Size 16  
 28 Size 20  
 I, F, P

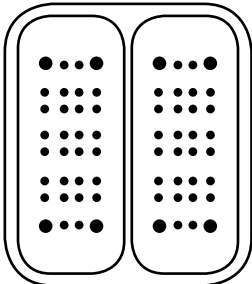

**FL\*-64A**  
 8 Size 16  
 56 Size 20  
 I, F

Accessories

Backshells can be used to complement the DEUTSCH STRIKE Series connectors. The backshells are designed to snap onto the connectors and accept convoluted tubing. The backshells assist with wire routing to ease engagement and disengagement of the lever lock.

■ Backshells

Backshell	Part Number	Size	Direction	Convoluted Tubing	Description
	SRK-BS-MD-90-001 SRK-BS-MD-90-002	Medium	90°	NW17 & 22(-001) NW22(-002)	90° plastic backshell for medium or full size plugs and receptacles
	SRK-BS-FL-90-001 SRK-BS-FL-90-002	Full		NW22 & 26(-001) NW26(-002)	
	SRK-BS-MD-ST-001 SRK-BS-MD-ST-002	Medium	Straight	NW17(-001) NW22(-002)	Straight plastic backshell for medium or full size plugs and receptacles
	SRK-BS-FL-ST-001 SRK-BS-FL-ST-002	Full		NW22(-001) NW26(-002)	

## How To Instructions

### ■ Contact Insertion

---



**Step 1:**  
Ensure TPA locking is open.



**Step 2:**  
Hold connector with rear seal retainer facing you.



**Step 3:**  
Push contact straight into the grommet until a positive stop is felt. A slight tug will confirm that it is properly locked in place.



**Step 4:**  
Push to close the TPA. TPA will not close unless all contacts are fully seated in connector.

### ■ Contact Removal

---



**Step 1:**  
Use DT-RT1 to open the TPA with light turn against the locking clip.



**Step 2:**  
Repeat step 1 on the other side of the TPA.



**Step 3:**  
Remove the TPA.



**Step 4:**  
Unlock the contacts and pull on the wire.

# Bussing Options



## Contents

DT Bussed Feedback Overview 86

---

DT Family Part Numbering System 86

---

DT Series Dimensions 86

---

DT Bussed Arrangements 87-88

---

HDFB Series Overview 88

---

HDFB Part Numbering System 88

---

HDFB Series Dimensions 89

---

HDFB Series Arrangements 89

---

HDFB Series Accessories 89

---

# Bussing Options

## Bussed Overview

DEUTSCH industrial bussed feedback receptacles are environmentally sealed connectors designed for use in heavy duty applications where multiple circuits require a common electrical pathway. Available in the DT and HDFB Series, DEUTSCH bussed connectors feature integrated bussbars with standard DEUTSCH contacts.

A bussbar, or buss, is a thin conductive strip connecting two or more contacts within the body of a connector. Bussbars allow power or data to be fed into a connector through one or more terminals and drawn out as needed through the other contacts on the same buss. Connectors can carry one or more bussbars, creating multiple independent electrical circuits within the same connector body and distributing power or data to many components. A single bussed connector can replace several standard connectors or splices, saving space, wiring, and weight.

### DT Series Bussed Feedback Receptacles

DT bussed feedback receptacles are a compact economical bussing option housed in rugged, field-proven DT receptacle bodies. The bussed DTs mate with standard DT plugs and meet all the performance specifications for the DT Series. The connectors are available in multiple buss configurations using standard size 16 contacts, with plating options in nickel or gold.

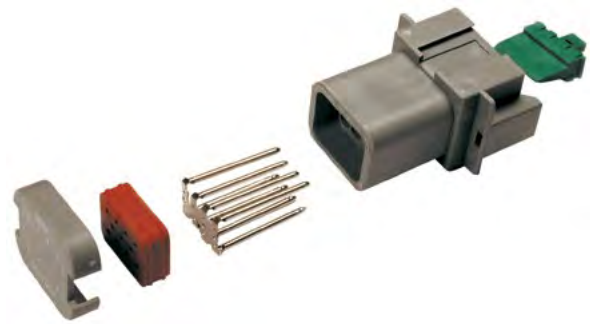

### DT Family Part Numbering System

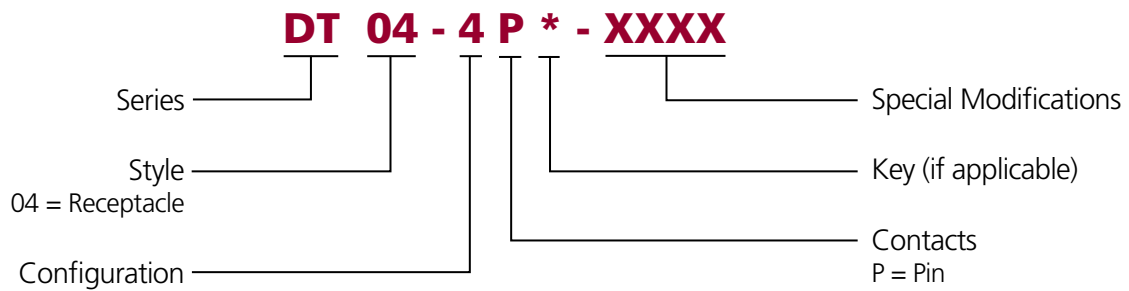

### DT Series Dimensions

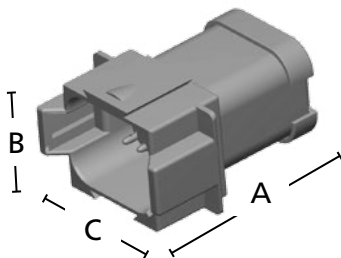

Cavity	DT Receptacle		
	Overall Length A	Overall Height B	Overall Width C
2	1.818 (46.18)	.670 (17.15)	.675 (17.15)
4	1.868 (47.45)	.797 (20.24)	.820 (20.83)
6	1.858 (47.19)	.972 (24.69)	.820 (20.83)
8	1.848 (46.94)	1.000 (25.40)	1.435 (36.45)
12	2.043 (51.89)	.876 (22.25)	1.597 (40.56)

Dimensions are for reference only.



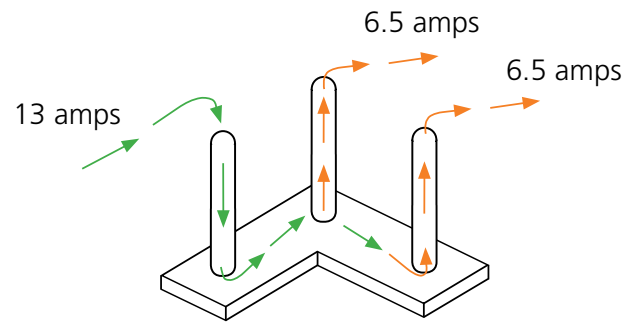
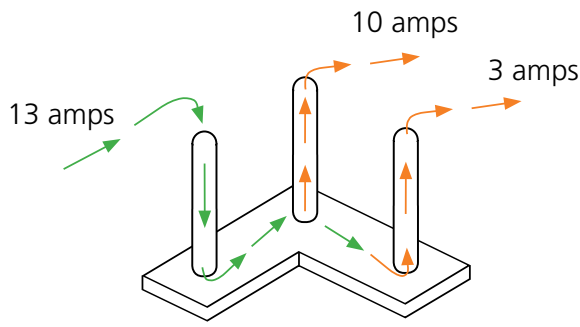

In the examples, there are three size 16 pins each rated for 13 amps mounted to the buss. A total of 13 amps can be pulled into one pin and going out the 13 amps are split between the remaining two pins. No more than 13 amps can go through any single pin.

### Notice

The maximum current rating is the total amount of current for the entire buss. Current can be distributed in many combinations, but cannot exceed 13 amps per contact.

### DT Series Bussed 2, 4, 6, & 8 Way Arrangements

Bussing Arrangements	Maximum Current Rating*	Bus Plating	Connector Color	Receptacle Part Number	Mating Plug Part Number
 (1) 2	(1) 2 Pin Buss=13 amps	Nickel	Black	DT04-2P-P060	DT06-2S-****
 (1) 4	(1) 4 Pin Buss=26 amps	Nickel Nickel	Black Gray	DT04-4P-EP13 DT04-4P-P021	DT06-4S-**** DT06-4S-****
 (1) 6	(1) 6 Pin Buss=39 amps	Nickel Nickel	Black Gray	DT04-6P-EP13 DT04-6P-P021	DT06-6S-**** DT06-6S-****
 (2) 3's	(2) 3 Pin Busses=13 amps each	Nickel	Black	DT04-6P-EP14	DT06-6S-****
 (1) 8	(1) 8 Pin Buss=52 amps	Nickel Nickel	Gray Black	DT04-08PA-P021 DT04-08PB-P021	DT06-08SA-**** DT06-08SB-****
 (1) 3, (1) 5	(1) 3 Pin Buss=13 amps (1) 5 Pin Buss=26 amps	Nickel Nickel	Gray Black	DT04-08PA-P028 DT04-08PB-P028	DT06-08SA-**** DT06-08SB-****
 (2) 4's	(2) 4 Pin Busses=26 amps each	Nickel Nickel	Gray Black	DT04-08PA-P026 DT04-08PB-P026	DT06-08SA-**** DT06-08SB-****

\*Maximum current rating is the total amperage for the buss

# Bussing Options

## DT Series Bussed 12 Way Arrangements

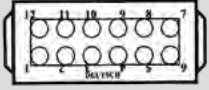
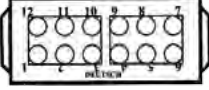
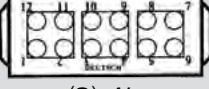
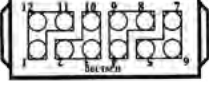
Bussing Arrangements	Maximum Current Rating*	Buss Plating	Connector Color	Receptacle Part Number	Mating Plug Part Number
 (1) 12	(1) 12 Pin Buss=78 amps	Gold Gold Nickel Nickel	Gray Black Gray Black	DT04-12PA-P016 DT04-12PB-P016 DT04-12PA-P021 DT04-12PB-P021	DT06-12SA-**** DT06-12SB-**** DT06-12SA-**** DT06-12SB-****
 (2) 6's	(2) 6 Pin Busses=39 amps each	Nickel Nickel Gold	Gray Black Black	DT04-12PA-P026 DT04-12PB-P026 DT04-12PB-P027	DT06-12SA-**** DT06-12SB-**** DT06-12SB-****
 (3) 4's	(3) 4 Pin Busses=26 amps each	Nickel	Gray	DT04-12PA-P075	DT06-12SA-****
 (4) 3's	(4) 3 Pin Busses=13 amps each	Nickel Nickel Gold Gold	Gray Black Gray Black	DT04-12PA-P030 DT04-12PB-P030 DT04-12PA-P031 DT04-12PB-P031	DT06-12SA-**** DT06-12SB-**** DT06-12SA-**** DT06-12SB-****

\*Maximum current rating is the total amperage for the buss

## HDFB Series Overview

DEUTSCH HDFB connectors are self-contained, environmentally sealed, bussed feedback modules designed for use in heavy duty applications. Available in five bussing arrangements with two contact sizes, each HDFB holds one or more integrated busses formed from standard DEUTSCH pin contacts and a thin conductive strip. HDFBs mount in place with lightweight aluminum brackets, and the pins inside mate with standard DEUTSCH sockets.



## HDFB Series Part Numbering System

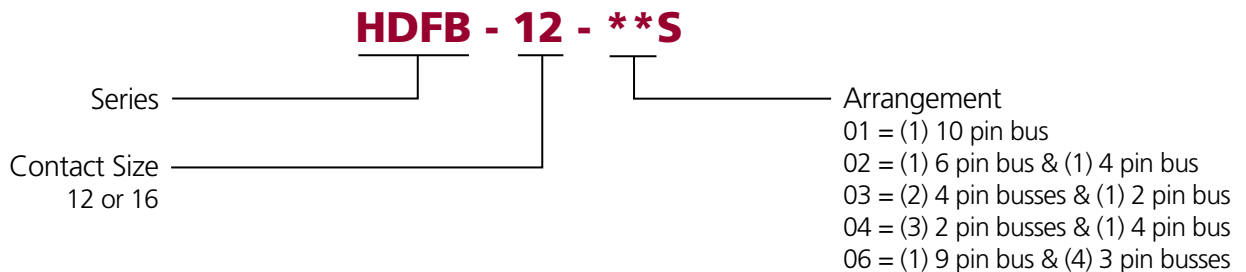

## HDFB Series Dimensions

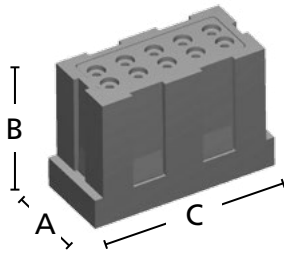

Bussing Arrangement	HDFB Receptacle		
	Overall Length A	Overall Height B	Overall Width C
01-04	1.197 (30.40)	1.589 (40.36)	2.310 (58.67)
06	1.197 (30.40)	1.619 (41.12)	2.326 (59.08)

Dimensions are for reference only.

## HDFB Series Arrangements

### Size 12 Contacts

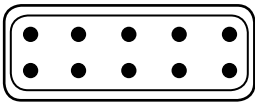

**HDFB-12-01S**  
01 Arrangement

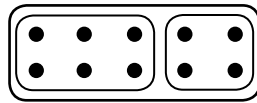

**HDFB-12-02S**  
02 Arrangement

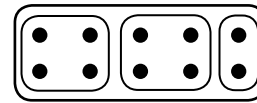

**HDFB-12-03S**  
03 Arrangement

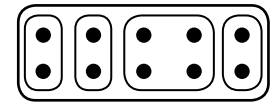

**HDFB-12-04S**  
04 Arrangement

### Size 16 Contacts

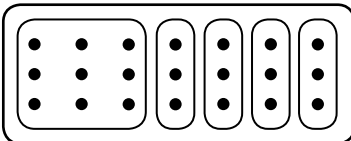

**HDFB-16-06S**  
06 Arrangement

## Accessories

Mounting brackets are available for use with the HDFB Series. The brackets are aluminum and accommodate two or three HDFB modules. Please request a drawing for mounting specifications.

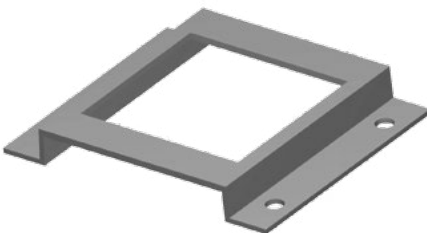

### Mounting Brackets

Part Number	Description
0427-202-0290	2 module capacity mounting bracket, outside dimensions 3.575 x 3.019 (90.81 x 76.68)
0427-201-0390	3 module capacity mounting bracket, outside dimensions 3.575 x 4.016 (90.81 x 102.01)



# Controller Area Networks



## Contents

CAN Overview	92
J1939/13 9-pin Diagnostic	93
J1939/11 Connector Options	94
J1939/15 Connector Options	95
ISO Box	95

## CAN Overview

Controller Area Networks, or CAN, are multiplex data systems. Multiplexing allows multiple data signals to travel on the same wires, integrating separate electronic systems and applications to a single point control and monitoring system. Using signals sent over a serial network, CAN systems provide instantaneous monitoring of diagnostic and control systems allowing early detection of potential problems. Early detection of problems leads to lower repair costs and reduced downtime. CAN systems allow an operator to use a single command station to control diagnostic systems and receive such varied information as brake and transmission temperature, tire pressure, fuel efficiency, and emissions levels. Anything that can be measured and controlled electronically can be monitored and directed by a CAN system.

Whether you're building a Controller Area Network for anything from on/off-highway, construction, material handling, agriculture machines, or your OEM fleet of fire engines, there is a DEUTSCH solution for your CAN needs. Options include several configurations: 2-wire, 3-wire, and 4-wire, with in-line and flange mount, along with splitters, heavy duty breakaway connectors, and an off-board 9-pin diagnostic connector.

SAE J1939 is a specific type of CAN that defines the communications pathways for vehicle networks. Improved electrical systems as defined under SAE J1939 allow electrical devices to communicate with each other. Communication occurs using a Controlled Area Network between intelligent sensors over a serial network. Through a series of microprocessors a CAN interconnects every device establishing a common link between each.

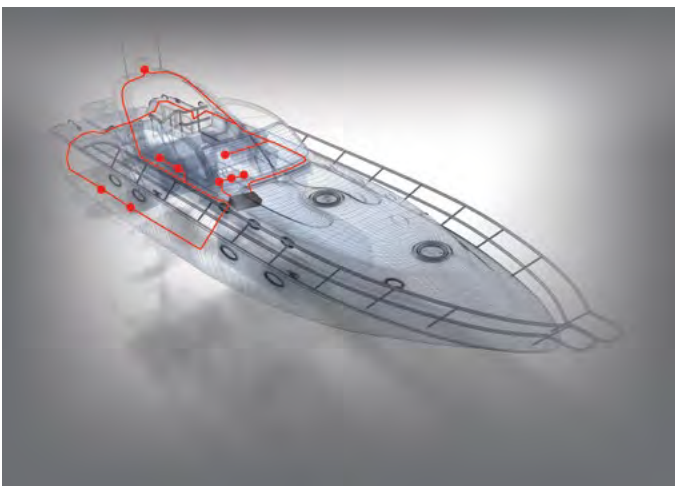

There are four main electrical interconnect subsets of J1939 including /11, /12, /13, and /15:

- J1939/11 is a 3-wire system that uses the DEUTSCH DT Series connectors primarily for truck and bus. The DT Series accepts size 16 contacts and 14-20 AWG. Connector options include in-line, bulkhead, "Y" splitter, and terminating resistors.
- J1939/12 is a system that requires the DEUTSCH DT Series, HD30 Series, and ISO Box (HDBox). This group of electrical interfaces terminates a CAN between the tractor and its implement. Its main feature is a breakaway function that prevents damage to the tractor or implement in case of an accidental drive-away disconnect.
- J1939/13 is a system that uses the DEUTSCH HD10 Series connectors for on-board diagnostics. The HD10 Series accepts size 16 contacts and 14-20 AWG.
- J1939/15 is a 2-wire system that uses the DEUTSCH DTM Series connectors. The DTM Series accepts size 20 contacts and 16-22 AWG. Connector options include in-line, "Y" splitter, and terminating resistors.

The continued sophistication in design of equipment is demanding increased response of electrical systems. The application of J1939 has allowed designers to improve both the quantity and the quality of the options offered along with the increased electrical system reliability.

## ■ J1939/13 Universal 9-pin Diagnostic

Part Number	Description
HD10-9-1939P	Receptacle
HD10-9-1939P-B022	Receptacle, Panel Nut Mount
HD10-9-1939PE-B022	Receptacle, Panel Nut Mount, Reduced Wire Seal
HD10-9-1939PE	Receptacle, Reduced Wire Seal
HD16-9-1939S	Plug, Coupling Ring
HD16-9-1939SE	Plug, Coupling Ring, Reduced Wire Seal
HD17-9-1939S	Plug, No Coupling Ring (Slip-on)
HD17-9-1939SE	Plug, No Coupling Ring (Slip-on), Reduced Wire Seal
0460-202-1631	Pin, Solid, Size 16, Gold
0460-247-1631	Pin, Solid, Size 16, Gold, Extended
0462-201-1631	Socket, Solid, Size 16, Gold
0462-221-1631	Socket, Solid, Size 16, Gold, Extended

DEUTSCH J1939/13, HD10 9 pin connector is a standard diagnostic tool interface for on- and off-highway OEMs. The HD10-9-1939P is a data port connector designed to allow an on-board CAN system to mate with a diagnostic computer. The connectors are for use with the 250 kbps network. The DEUTSCH HD10 J1939/13 connectors offer several mounting options for the receptacle, and a mating plug that is available with or without a coupling ring.



## ■ J1939/13 Type II Universal 9-pin Diagnostic

Part Number	Description
HD10-9-1939P-P080	Receptacle, Flange Mount, Type II
HD10-9-1939PE-P080	Receptacle, Flange Mount, Type II, Reduced Wire Seal
HD10-9-1939P-BP03	Receptacle, Panel Nut Mount, Type II
HD10-9-1939PE-BP03	Receptacle, Panel Nut Mount, Type II, Reduced Wire Seal
HD14-9-1939P-P080	Receptacle, Type II
HD14-9-1939PE-P080	Receptacle, Type II, Reduced Wire Seal
HD16-9-1939S-P080	Plug, Coupling Ring, Type II
HD16-9-1939SE-P080	Plug, Coupling Ring, Type II, Reduced Wire Seal
HD17-9-1939S-P080	Plug, No Coupling Ring (Slip-on), Type II
HD17-9-1939SE-P080	Plug, No Coupling Ring (Slip-on), Type II, Reduced Wire Seal
0460-202-1631	Pin, Solid, Size 16, Gold
0460-247-1631	Pin, Solid, Size 16, Gold, Extended
0462-201-1631	Socket, Solid, Size 16, Gold
0462-221-1631	Socket, Solid, Size 16, Gold, Extended

DEUTSCH J1939/13, HD10 9 pin connector is a standard diagnostic tool interface for on- and off-highway OEMs. The HD10-9-1939P\*-P080 is a data port connector designed to allow an on-board CAN system to mate with a diagnostic computer. The green, Type II connectors, HD10-9-1939P-P080, are for use with the 500 kbps network. The DEUTSCH HD10 J1939/13 connectors offer several mounting options for the receptacle, and a mating plug that is available with or without a coupling ring.



# Controller Area Networks

## ■ SAE J1939/11 DEUTSCH Connector Options

Part Number	Description
DT04-3P-P007	Receptacle, "Y" Connector
DT04-3P-E008	Receptacle, Gray, Shrink Boot Adapter
DT04-3P-P006	Receptacle, Gray, 120 Ohm Resistor
DT04-3P-EE01	Receptacle, Black, Shrink Boot Adapter
DT04-3P-EP10	Receptacle, Black, 120 Ohm Resistor
DT06-3S-E008	Plug, Gray, Shrink Boot Adapter
DT06-3S-P006	Plug, Gray, 120 Ohm Resistor
DT06-3S-EP11	Plug, Black, Shrink Boot Adapter
DT06-3S-PP01	Plug, Black, 120 Ohm Resistor
DT06-3S-PE01	Plug, Black, 120 Ohm Resistor, Latch Guard
DT06-3S-P032	Plug, Black, Single Piece Shrink Boot Adapter
W3P-1939	Wedgelock, Blue
W3S	Wedgelock, Orange
W3S-P012	Wedgelock, Green
W3S-1939	Wedgelock, Blue
W3S-1939-P012	Wedgelock, Blue
0460-202-1631	Pin, Solid, Size 16, Gold
1060-16-0144	Pin, Stamped & Formed, Size 16, Gold
0460-247-1631	Pin, Solid, Size 16, Gold, Extended
0462-201-1631	Socket, Solid, Size 16, Gold
1062-16-0144	Socket, Stamped & Formed, Size 16, Gold
0462-221-1631	Socket, Solid, Size 16, Gold, Extended

DEUTSCH J1939/11 connectors are rugged field proven DT 3 pin connectors designed to meet the SAE requirements for 3-wire CAN applications linking ECUs for serial data communications. The DT 3 way connectors accommodate the CAN\_HI, CAN\_LO and shield wires with a variety of options including "Y" receptacles, connectors with mounting flanges, keyed wedgelocks to prevent mis-mating, and network terminating connectors with molded-in 120Ω resistors.





## SAE J1939/15 DEUTSCH Connector Options

Part Number	Description
DTM04-2P-P007	Receptacle, "Y" Connector
DTM04-2P-E007	Receptacle, Gray, Shrink Boot Adapter
DTM04-2P-P006	Receptacle, Gray, 120 Ohm Resistor
DTM04-2P-EE03	Receptacle, Black, Shrink Boot Adapter
DTM06-2S-E007	Plug, Gray, Shrink Boot Adapter
DTM06-2S-P006	Plug, Gray, 120 Ohm Resistor
DTM06-2S-EE03	Plug, Black, Shrink Boot Adapter
DTM06-2S-EP10	Plug, Black, 120 Ohm Resistor
WM-2P	Wedglock, Orange
WM-2PA	Wedglock, Gray
WM-2PB	Wedglock, Black
WM-2S	Wedglock, Orange
WM-2SA	Wedglock, Gray
WM-2SB	Wedglock, Black
0460-202-2031	Pin, Solid, Size 20, Gold
1060-20-0144	Pin, Stamped & Formed, Size 20, Gold
0462-201-2031	Socket, Solid, Size 20, Gold
1062-20-0144	Socket, Stamped & Formed, Size 20, Gold

SAE J1939/15 defines the requirements for reduced physical layer 2-wire CAN systems consisting of an unshielded twisted pair of wires. DEUTSCH DTM 2 way connectors are offered in several modifications to meet the requirements of this standard. DTM connectors for serial data communications include "Y" receptacles, connectors with end caps and shrink boot adapters, and receptacles with molded-in 120Ω resistors for network terminations.



## ISO/CD 11783-2 & J1939/12 ISO Box and Associated Connectors

Part Number	Description
HDBOX-24-91PN	ISO Box Assembly
HDBOX-24-91PE	ISO Box Assembly, Reduced Wire Seal
HD36-24-91SN-059	Plug, Cable Clamp Assembly
HD36-24-91SE-059	Plug, Cable Clamp Assembly, Reduced Wire Seal
HDB36-24-91SN-059	Plug, Breakaway Coupling, Cable Clamp Assembly
HDB36-24-91SE-059	Plug, Breakaway Coupling, Cable Clamp Assembly, Reduced Wire Seal
DT06-4S-EP06*	Plug, Black, End Cap
DT06-2S-EP06*	Plug, Black, End Cap
W4S-P012	Wedglock, Green
W2S-P012	Wedglock, Green
0460-204-08141	Pin, Solid, Size 8
0460-204-12141	Pin, Solid, Size 12
0460-202-1631	Pin, Solid, Size 16, Gold
0462-203-08141	Socket, Solid, Size 8
0462-203-12141	Socket, Solid, Size 12
0462-201-1631	Socket, Solid, Size 16, Gold

Originally designed for agricultural applications, the DEUTSCH J1939/12 ISO Box creates a communication pathway between an on-board CAN system and the electronic components on an attached implement. The HDBox, which holds two DT13 connectors and an HD30 Series receptacle, mounts on the vehicle and mates with an HD30 plug connector that features a breakaway coupling ring. DEUTSCH breakaway couplings are designed to help prevent damage to the vehicle or the attached implement by fragmenting and separating from the vehicle in the event of a drive-away disconnect.



\*DT Series receptacles are molded in the HDBox



# Diodes & Resistors



## Contents

Diodes & Resistors Overview	98
Part Numbering System	98
Configurations	98
Diode & Resistor Characteristics	99

## Diodes & Resistors Overview

DEUTSCH DT connectors with diodes and resistors are useful anywhere you need to regulate power or protect a device against a potential power surge.

A diode allows current to flow in one direction only. By preventing current from traveling a circuit in the wrong direction, a diode can protect an electronic device from damage. Devices with batteries will often use diodes to prevent power from flowing in reverse if the battery is not installed correctly.

A resistor limits or blocks current flow in both directions. Resistors protect sensitive electronics by limiting the amount of electricity that can flow to the device through the resistor, and therefore preventing power spikes. For example, resistors are used to prevent power surges from burning out an LED by restricting current flow to the light.

DEUTSCH diode and resistor connectors are easily added to an application after the fact if unwanted power surges are discovered.

### Part Numbering System

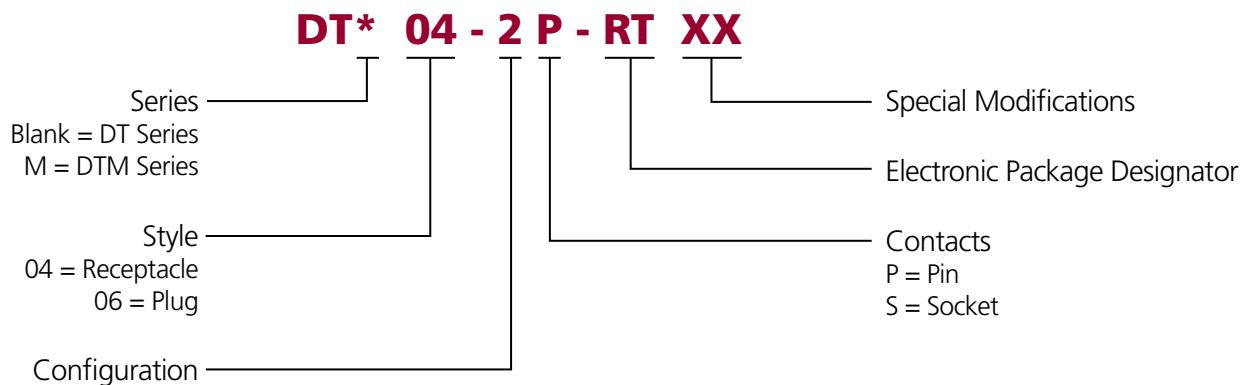

### Diode & Resistor Configurations

*Notice*  
Please see DT Family for connector dimensions.

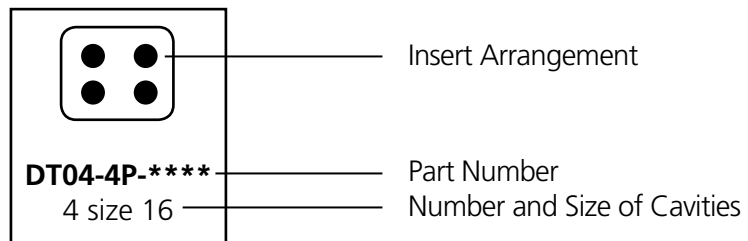

### DTM Series Configurations

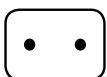

**DTM0\*-2\*-\*\*\*\***  
2 size 20

### DT Series Configurations

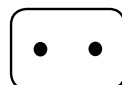

**DT0\*-2\*-\*\*\*\***  
2 size 16

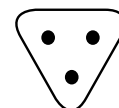



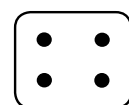

**DT0\*-3\*-\*\*\*\***  
3 size 16











**DT0\*-4\*-\*\*\*\***  
4 size 16

## ■ DEUTSCH Diode Characteristics

DT Series	Part Number	Plug or Receptacle	Diode Part Number	Peak Reverse Volts	Peak Forward Volts	Avg. Forward Current	Color
	DT04-2P-RT01	Receptacle	Motorola Diode: MUR460	600 V max.	1.28 V max.	4.0 A max.	Black
	DT04-2P-RT02	Receptacle	Toshiba Diode: 3GZXX	400 V max.	1.0 V max.	3.0 A max.	Black
	DT04-4P-RT01	Receptacle	Motorola Diode: MUR460 (3)	600 V max.	1.28 V max.	4.0 A max.	Black
	DT04-4P-RT03	Receptacle	Motorola Diode: MUR460 (2)	600 V max.	1.28 V max.	4.0 A max.	Gray

## ■ DEUTSCH Resistor Characteristics

DTM Series	Part Number	Plug or Receptacle	Resistor Ohms	Resistor Watts	Resistor Tolerance	Color
	DTM04-2P-EP10	Receptacle	120	0.4	5%	Black (B keyed wedgelock included)
	DTM04-2P-P006	Receptacle	120	0.4	5%	Gray (A keyed wedgelock included)
	DTM06-2S-EP10	Plug	120	0.4	5%	Black (B keyed wedgelock included)
	DTM06-2S-P006	Plug	120	0.4	5%	Gray (A keyed wedgelock included)
DT Series	Part Number	Plug or Receptacle	Resistor Ohms	Resistor Watts	Resistor Tolerance	Color
	DT04-2P-RT25	Receptacle	27k	0.5	1%	Black
	DT04-3P-EP10	Receptacle	120	0.4 min.	10%	Black (J1939 keyed wedgelock included)
	DT04-3P-P006	Receptacle	120	0.4 min.	10%	Gray (J1939 keyed wedgelock included)
	DT06-3S-EP10	Plug	120	0.4 min.	10%	Black (J1939 keyed wedgelock included)
	DT06-3S-P006	Plug	120	0.4 min.	10%	Gray (J1939 keyed wedgelock included)





# Printed Circuit Board



## Contents

Printed Circuit Board Overview	102
PCB Connector Options	102
AMPSEAL Connectors	103
DRC Series	103-105
DT Family	105-107
HD10 Series	107
STRIKE Series	108
PCB Enclosures and Headers	108-110

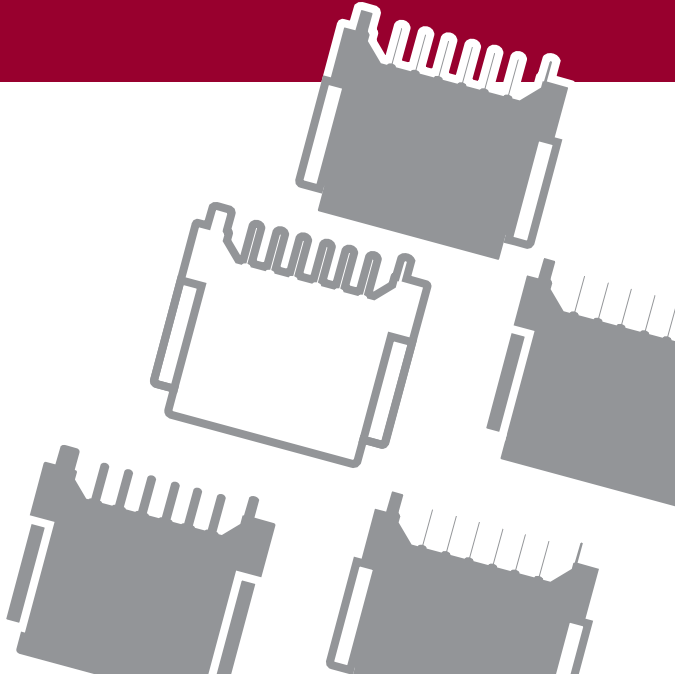

# Printed Circuit Board Connectors

## Printed Circuit Board Overview

Printed circuit board or PCB connectors are heavy duty environmentally sealed connectors designed for wire-to-circuit board connections. TE Connectivity's Industrial & Commercial Transportation connectors are built to maintain the integrity and continuity of data and power signals in harsh environments. Developed and designed for heavy duty electronically equipped vehicles, TE Connectivity's printed circuit board connector bodies will withstand dust, dirt, moisture, and vibration.

Available in a variety of styles from several different connector families, TE Connectivity's printed circuit board connectors cover a range of pin counts from 2 to 76 and wire gauges from 10 to 22. Many of the connectors are available in straight, 90°, or solder pot options.

### ■ Printed Circuit Board Connector Options

#### AMPSEAL Connectors

- 8, 14, 23, and 35 cavity arrangements
- Mating connectors accept 16-20 AWG

#### DRC Series

- 24, 40, 50, 60, 64, 70, and 76 cavity arrangements
- Mating connectors accept 14-22 AWG

#### DT Family

- DT Series 2, 3, 4, 6, 8, and 12 cavity arrangements
- DT Series mating connectors accept 14-20 AWG
- DT Series flangeless options available
- DTM Series 8, 12, and 48 cavity arrangements
- DTM Series mating connectors accept 16-22 AWG
- DTM Series flangeless 48 way option
- DTP Series 4 cavity arrangement
- DTP Series mating connectors accept 10-14 AWG
- Some arrangements of the DT and DTM Series are available with **A**, **B**, **C**, and **D** keying options

#### HD10 Series

- 6 and 9 cavity arrangements
- Mating connectors accept 14-20 AWG

#### STRIKE Series

- 32 cavity arrangement
- Mating connectors accept 14-22 AWG

#### EEC Enclosure and Flange Receptacle

- DT Series header 12, 24, 36, and 48 cavity arrangements
- DT Series mating connectors accept 14-20 AWG
- DTM Series header 12 and 24 cavity arrangements
- DTM Series mating connectors accept 16-22 AWG
- Some arrangements of the DT and DTM Series are available with **A**, **B**, **C**, and **D** keying options



### Notice

See individual series sections for part numbering system.



## AMPSEAL Connectors

### Materials

Cover: Glass filled PBT  
 Wire Seal: Silicone rubber  
 Contacts: Tin or gold plated brass

### Mating Plugs

8 Position: 776286-  
 14 Position: 776273-  
 23 Position: 770680-  
 35 Position: 776164-

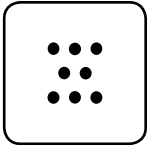

**8 Positions**  
 8 size 1.3 mm

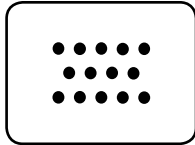

**14 Positions**  
 14 size 1.3 mm

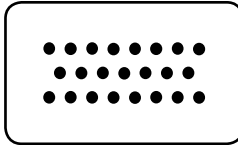

**23 Positions**  
 23 size 1.3 mm

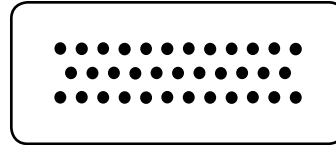

**35 Positions**  
 35 size 1.3 mm



*By fixing the connectors to the board prior to soldering, pressure can be greatly reduced at the solder joint.*

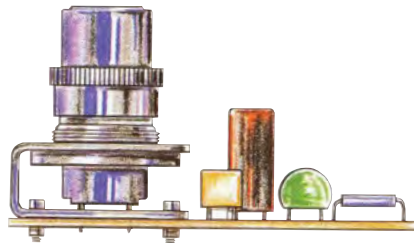

## DRC10 Series Straight

### Materials

Housing: Thermoplastic  
 Grommet: Silicone elastomer  
 Receptacle Threaded Insert: Steel  
 Contacts: Molded-in copper alloy, tin plated solder pot standard (gold optional - see modifications)

### Mating Plugs

24 Pin: DRC16-24S\*  
 40 Pin: DRC16-40S

### Modifications

A004: Tin plated PCB pins  
 AG02: Some terminals are gold plated

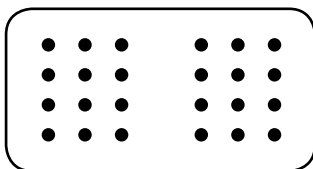

**DRC10-24P\***  
 24 size 16

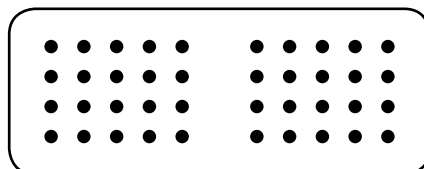

**DRC10-40P\***  
 40 size 16

# Printed Circuit Board Connectors

## ■ DRC13 Series 90°

### Materials

Housing: Thermoplastic

Receptacle Threaded Insert: Steel/  
Brass

Contacts: Molded-in copper alloy,  
tin plated PCB pins standard (gold  
optional - see modifications)

Mounting Seal: Silicone

### Mating Plugs

24 Pin: DRC16-24S\*

40 Pin: DRC18-40S\*

70 Pin: DRC16-70S\*

### Modifications

C023: 5mm<sup>2</sup> threaded insert  
mounting holes

G002: Only outside terminal rows  
are gold plated

N012: One piece connector  
design

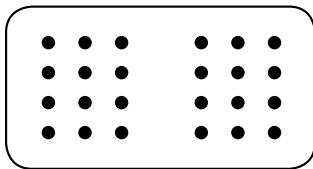

**DRC13-24P\***  
24 size 16

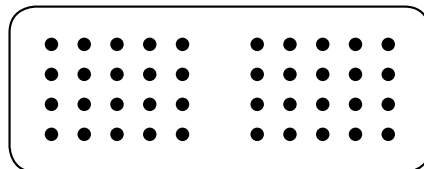

**DRC13-40P\***  
40 size 16

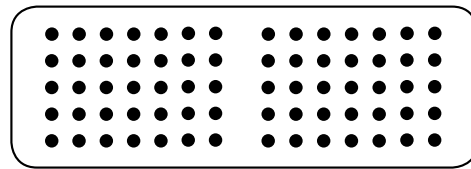

**DRC13-70P\***  
70 size 16

## ■ DRC20/22 Series Straight

### Materials

Housing: Thermoplastic

Grommet: Silicone elastomer

Receptacle Threaded Insert: Steel

Contacts: Molded-in copper alloy,  
gold plated mating side, tin plated  
PCB side (size 12 contacts are tin  
plated on mating and PCB sides)

Mounting Seal: Silicone rubber

### Mating Plugs

50 Pin: DRC26-50S\*\*

60 Pin: DRC26-60S\*\*

76 Pin: (2)DRC26-38S\*\*

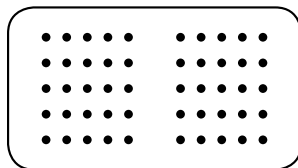

**DRC2\*-50P\***  
50 size 20

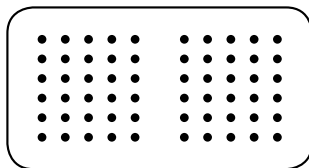

**DRC20-60P\***  
60 size 20

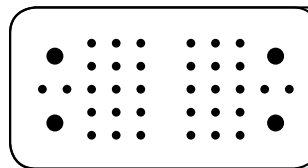

**DRC20-76P\*\*\*\***  
68 size 20, 8 size 12

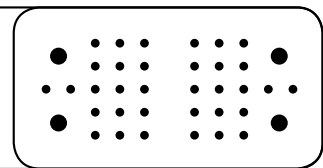

## ■ DRC23 Series 90°

### Materials

Housing: Thermoplastic  
 Grommet: Silicone elastomer  
 Receptacle Threaded Insert: Steel  
 Contacts: Molded-in copper alloy, gold plated PCB pins standard (tin optional)  
 Mounting Seal: Silicone rubber

### Mating Plugs

24 Pin: DRC26-24S\*  
 40 Pin: DRC26-40S\*  
 64 Pin: DRC26-24S\*, DRC26-40S\*

### Modifications

N010: Custom mount  
 N012: One piece connector design

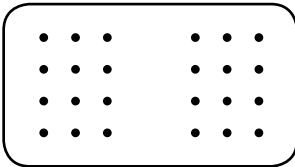

**DRC23-24\*\***

24 size 20

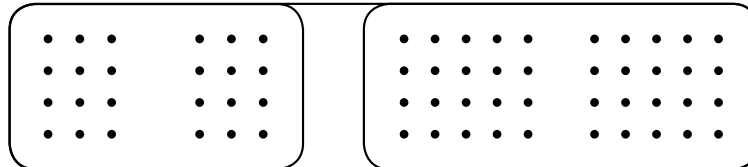

**DRC23-64\*\***

64 size 20

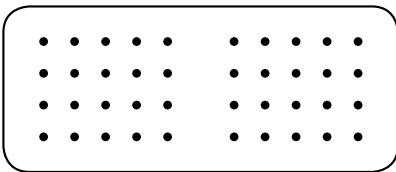

**DRC23-40\*\***

40 size 20

## ■ DT13/15 Series 90° or Straight

### Materials

Housing: Thermoplastic  
 Contacts: Molded-in copper alloy, nickel plated mating side, tin plated PCB side (gold optional - contact your representative)  
 Mounting Seal: Silicone rubber

### Mating Plugs

2 Pin: DT06-2S  
 4 Pin: DT06-4S  
 6 Pin: DT06-6S  
 8 Pin: DT06-8S\*  
 12 Pin: DT06-12S\*

### Modifications

B016: Extended shell and additional keys  
 G003: Gold plated pins

*Notice*  
 Camcar thread forming screws are recommended.  
 See drawing.

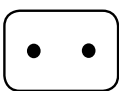

**DT1\*-2P**

2 size 16

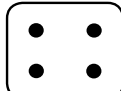

**DT1\*-4P**

4 size 16

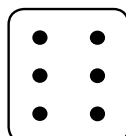

**DT1\*-6P**

6 size 16

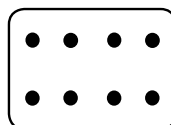

**DT1\*-08P\***

8 size 16  
 A, B, C, D

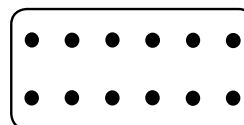

**DT1\*-12P\***

12 size 16  
 A, B, C, D



DT13

DT15

# Printed Circuit Board Connectors

## DTF13 Series Flangeless 90°

### Materials

Housing: Thermoplastic

Contacts: Molded-in copper alloy, tin plated (gold optional - contact your representative)

### Mating Plugs

2 Pin: DT06-2S

3 Pin: DT06-3S

4 Pin: DT06-4S

6 Pin: DT06-6S

12 Pin: DT06-12S\*

### Modifications

G003: Gold plated pins

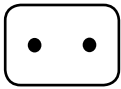

**DTF13-2P**  
2 size 16



**DTF13-3P**  
3 size 16

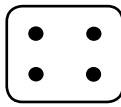

**DTF13-4P**  
4 size 16

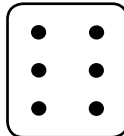

**DTF13-6P**  
6 size 16

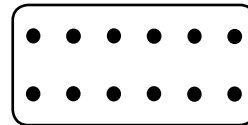

**DTF13-12P\***  
12 size 16  
A, B, C, D



## DTF15 Series Flangeless Straight

### Materials

Housing: Thermoplastic

Contacts: Molded-in copper alloy, tin plated (gold optional - contact your representative)

### Mating Plugs

12 Pin: DT06-12S\*

### Modifications

G003: Gold plated pins

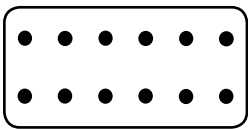

**DTF15-12P\***  
12 size 16  
A, B, C, D



## DTM13/15 Series 90° or Straight

### Materials

Housing: Thermoplastic

Contacts: Molded-in copper alloy, tin plated (gold optional - contact your representative)

Mounting Seal: Silicone rubber

### Mating Plugs

12 Pin: DTM06-12S\*

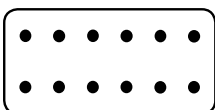

**DTM1\*-12P\***  
12 size 20  
A, B, C, D

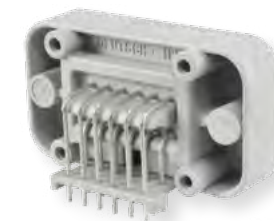

DTM13



DTM15

## DTMF15 Series Miniature Straight

### Materials

Housing: Thermoplastic

Contacts: Molded-in copper alloy, tin plated (gold optional - contact your representative)

### Mating Plugs

12 Pin: (4) DTM06-12S\*

### Modifications

B026: Alternate keying position

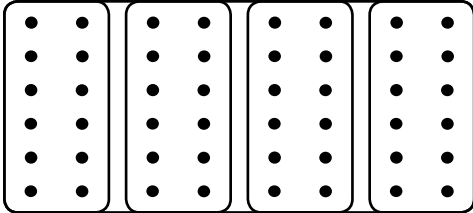

**DTMF15-48P**

(4)12 size 20



## DTP10/13/15 Series 90° or Straight

### Materials

Housing: Thermoplastic

Contacts: Molded-in copper alloy, tin plated

Mounting Seal: Silicone rubber

### Mating Plugs

4 Pin: DTP06-4S

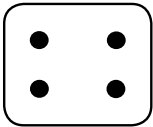

**DTP1\*-4P**

4 size 12



DTP10

DTP13

## HD10 Series Straight

### Materials

Housing: Thermoplastic

Contacts: Molded-in copper alloy, nickel plated

Mounting Seal: Standard O-rings may be used

### Mating Plugs

6 Pin: HD16-6-96S

9 Pin: HD16-9-96S

### Modifications

N005: Straight reduced diameter pins supplied as standard

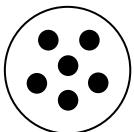

**HD10-6-96P-N005**

6 size 16

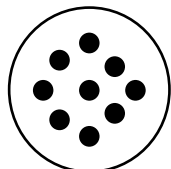

**HD10-9-96P-N005**

9 size 16



# Printed Circuit Board Connectors

## ■ STRIKE13/15 Series 90° or Straight

### Materials

Housing: Thermoplastic

Contacts: Molded-in copper alloy, tin plated (gold optional - contact your representative)

Mounting Seal: Silicone rubber

### Mating Plugs

32 Pin: SRK06-MD\*-32A-\*\*\*

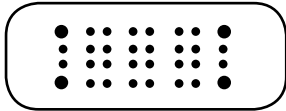

SRK1\*-MD\*-32A-001-\*\*\*\*

4 - Size 16

28 - Size 20



## Printed Circuit Board Enclosures and Headers

Compact circuit board enclosures that accept snap-in headers are available. The enclosure features a through hole mounting flange on each side, as well as optional venting. Designed with space to accommodate one or more DT or DTM Series interfaces, the headers feature 90° pins. A radial flange seal provides environmental sealing to the enclosure. The headers mate with the DT and DTM standard plugs.

## ■ DT Series Enclosure and Header Dimensions

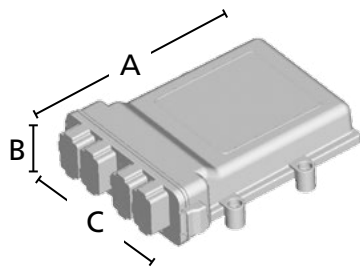

DT Series Enclosure with Header		
Overall Length	Overall Height	Overall Width
A	B	C
7.93 (201.30)	2.15 (54.63)	6.30 (160.00)

Dimensions are for reference only.

## ■ DT Header Connector

### Materials

Contacts: Molded-in tin (gold optional - contact your representative)

### Mating Plugs

12 Pin: DT06-12S\*

24 Pin: (2) DT06-12S\*

36 Pin: (3) DT06-12S\*

48 Pin: (4) DT06-12S\*

### Modifications

GR02: DT Series snap-in header with gold plated pins

R015: DT Series snap-in header

### Notice

Keying position of receptacle must match keying position of mating plug(s).



DT13-12PA-\*\*\*\*

12 size 16

A



DT13-24PAB-\*\*\*\*

(2) 12 size 16

A, B



DT13-36PABC-\*\*\*\*

(3) 12 size 16

A, B, C



DT13-48PABCD-\*\*\*\*

(4) 12 size 16

A, B, C, D

## DT PCB Enclosure

### Material

Housing: Thermoplastic

### Venting\*

A: With vent hole  
B: Without vent hole

### Board Size

5" X 6.50"



EEC-5X650\*

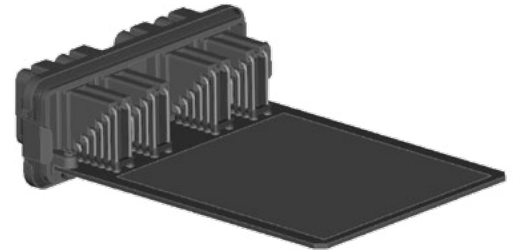
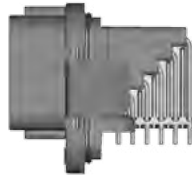

## DTM Series Enclosure and Header Dimensions

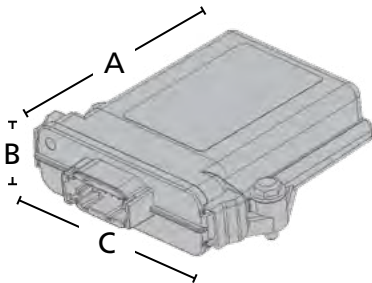

DTM Series Enclosure with Header		
Overall Length A	Overall Height B	Overall Width C
5.24 (133.03)	1.42 (36.00)	4.68 (118.80)

Dimensions are for reference only.

## DTM Header Connector

### Materials

Contacts: Molded-in nickel mating side, tin plated PCB side

### Mating Plugs

12 Pin: DTM06-12S\*  
24 Pin: (2) DTM06-12S\*

### Modifications

GR01: DTM Series snap-in header with gold plated pins  
R008: DTM Series snap-in header



DTM13-12P\*-\*\*\*\*

12 size 20  
A, B, C, D



DTM13-12PA-12PB-\*\*\*\*

(2) 12 size 20  
A, B



DTM13-12PC-12PD-\*\*\*\*

(2) 12 size 20  
C, D

# Printed Circuit Board Connectors

---

## ■ DTM PCB Enclosure

---

### Material

Housing: Thermoplastic

### Board Size

3.25" X 4"

### Venting\*

A: With vent hole

B: Without vent hole

### Modifications

E016: Molded in clear Ultem® material



EEC-325X4\*

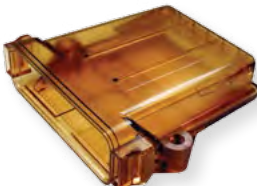

EEC-325X4\*-E016

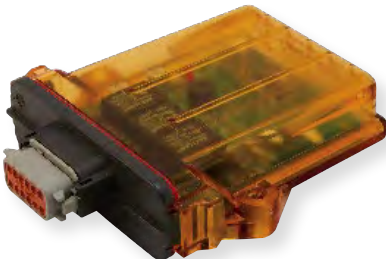



# Single Terminal



## Contents

DTHD Series Overview	112
DTHD Part Numbering System	112
DTHD Dimensions	112
DTHD Special Modifications	113
DTHD Accessories	113
Jiffy Splice Overview	114
Jiffy Splice Dimensions	114
Jiffy Splice How To Instructions	114

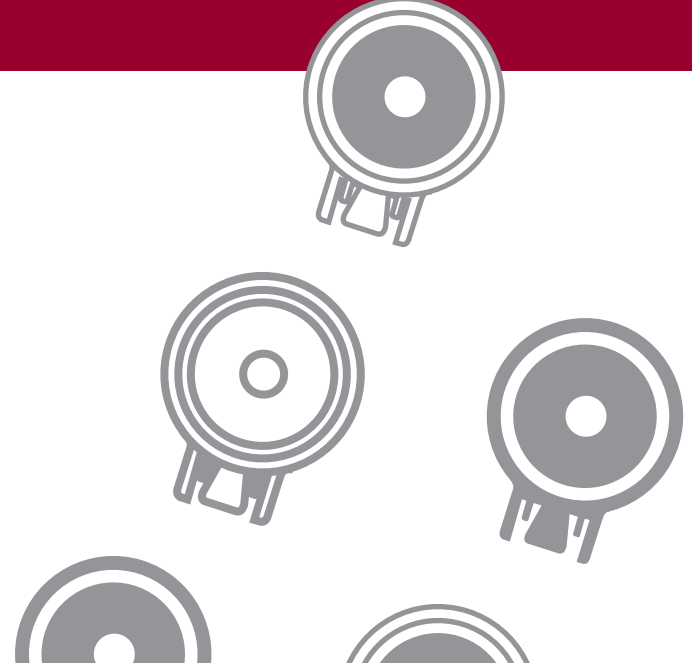

# Single Terminal Solutions

## Single Terminal Overview

Two different solutions are available for applications that require heavy duty single terminal connections. The DEUTSCH DTHD Series and Jiffy Splices provide environmentally sealed field-serviceable connections for the full range of wire gauges covered by the DEUTSCH contacts. The DTHD connectors are heavy duty power terminations for in-line and mounted applications. Jiffy Splices are lightweight in-line splices for quick connections. Both options provide easy installation and service with standard tools and contacts.

### ■ DTHD Series Overview

DTHD connectors are single terminal connectors for heavy duty applications. Easy to install, environmentally sealed and compact in size, they are a simple, field serviceable alternative to a splice. DTHD connectors are available in three sizes, carry 25 to 100 amps, and can be mounted or used in-line.



### ■ DTHD Series Part Numbering System

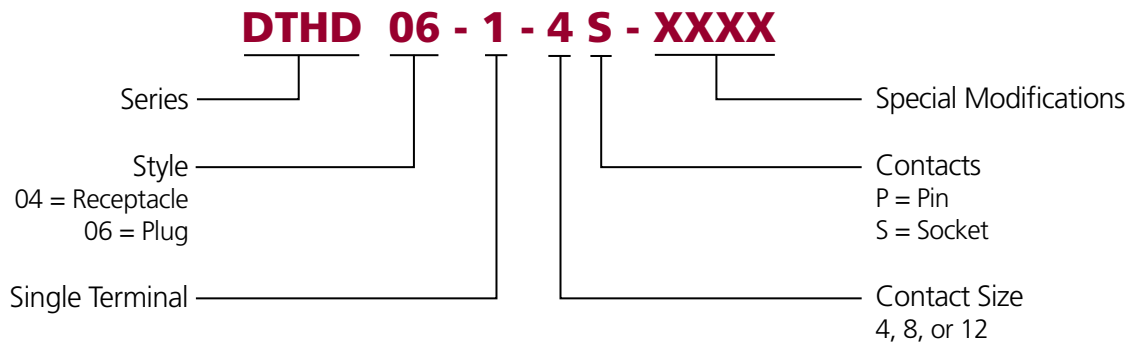

### ■ DTHD Series Dimensions



Contact Size	DTHD Plug			DTHD Receptacle		
	Overall Length A	Overall Height B	Overall Width C	Overall Length D	Overall Height E	Overall Width F
12	1.498 (38.05)	.771 (19.58)	.570 (14.48)	2.068 (52.53)	.850 (21.59)	.710 (18.08)
8	1.498 (38.05)	.861 (21.87)	.660 (16.76)	2.068 (52.53)	.940 (23.88)	.800 (20.32)
4	1.498 (38.05)	1.076 (27.33)	.875 (22.23)	2.068 (52.53)	1.170 (29.72)	1.045 (26.54)

Dimensions are for reference only.

## Special Modifications

The DTHD Series connectors offer modifications to enhance the design flexibility and meet application specific needs. Options include end caps and flanges.

### E003 Modification

The E003 is an end cap modification. The end cap is a protective cap that is sonically welded to the rear of the connector.



### L013 and L009 Modification

The L013 and L009 are sealed flange modifications. The L013 offers outside mounting and the L009 offers inside mounting.



L009



L013

## Accessories

There is a full line of mounting clips available for use with the DTHD Series. The mounting clips offer straight or side mounting and several material options. The mounting clips are designed to be used on all DTHD receptacles.

Mounting Clip	Part Number	Mounting Direction	Color/Material	Hole O.D. inches (mm)
	1027-003-1200	Straight	Stainless steel	.433 (11.0)
	1027-005-1200	Straight	Stainless steel	.512 (13.0)
	1027-004-1200	Straight	Steel w/ zinc plating	.512 (13.0)
	1027-008-1200	Side	Steel w/ zinc plating	.433 (11.0)
	1027-013-1200	Side	Steel w/ zinc plating	.323 (8.2)
	1011-026-0205	Straight	Gray plastic	.200 (5.08)
	1011-030-0205	Straight	Black plastic	---
	1011-310-0205* *Connector removable with 50N of force	Straight	Black plastic	---

# Single Terminal Solutions

## Jiffy Splice Overview



DEUTSCH Jiffy Splices are a unique, field-serviceable alternative to permanent splices. Made from the same high quality silicone elastomer as DEUTSCH connector seals and grommets, the Jiffy Splice body houses a contact retention system that secures a mated pair of contacts in a compact environmentally sealed unit. Jiffy Splices are easy to install and service.



Part Number	Size	A	B (min.)	Wire AWG	Insulation O.D.
JS-04-00	4	3.437 (87.30)	.765 (19.43)	6	.280-.292 (7.11-7.42)
JS-12-00	12	2.500 (63.50)	.500 (12.70)	12-14	.134-.170 (3.40-4.32)
JS-16-00	16	2.465 (62.61)	.385 (9.78)	14-20	.100-.134 (2.54-3.40)

Dimensions are for reference only.

### Notice

Jiffy Splices accept one pin and one socket.

## How To Instructions

### Contact Insertion

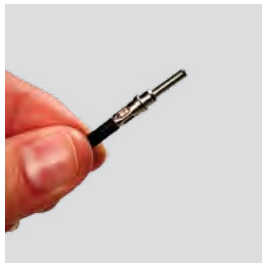

**Step 1:**  
Grasp contact approximately one inch behind the contact crimp barrel.



**Step 2:**  
Hold Jiffy Splice between thumb and forefinger approximately one half inch behind cavity.

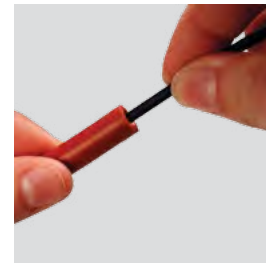

**Step 3:**  
Push contact straight into Jiffy Splice until a positive stop is felt. An audible "snap" will occur when correctly mated. A light tug will confirm it is properly seated.

### Contact Removal

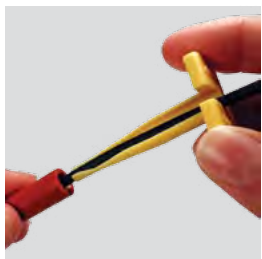

**Step 1:**  
Snap appropriate size removal tool over the wire.



**Step 2:**  
Hold Jiffy Splice between thumb and forefinger approximately one half inch behind cavity. Slide tool into cavity until resistance is felt and retaining fingers are engaged. Do not twist or insert tool at an angle.

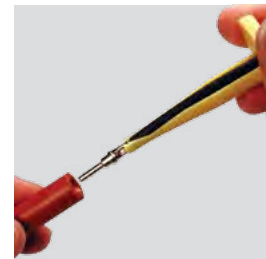

**Step 3:**  
Grip Jiffy Splice between thumb and forefinger and slowly pull contact wire assembly with removal tool out of cavity.

# Contacts



## Contents

Contacts Overview 116

---

Performance Specifications 117-118

---

Wire Sealing Ranges 119

---

Solid Contacts 120

---

Stamped & Formed Contacts 120-122

---

PCB Pins 123

---

Crimping 124

---

Crimp Inspection 125

---

Accessories 126-127

---

How To Instructions 128

---

## Contacts Overview

Several contacts are used interchangeably across most connector product lines. This commonality improves performance, reliability, and maintainability by reducing changes in the assembly of the wire harness. The use of the same contact systems helps eliminate many of the failures reported in harnesses where hundreds of different terminations are used.

### ■ Contact Styles

Two styles of contacts are available: solid and stamped & formed. Both contact types use a crimp style termination, eliminating the need for solder. The variations in the contact system are those dictated by wire gauge and contact style.

#### **Solid**

The solid contacts are designed for use with larger wire size and heavy duty applications. Solid contacts are manufactured using a cold heading process with solid copper alloy wire and are available with either a nickel or gold plating finish.

Solid contacts terminate wire from 4 AWG to 20 AWG (25 - 0.5mm<sup>2</sup>) and are available in 5 sizes each of the pin and socket. The applicable contact is determined by the size of the conductor only.

### ■ Design Materials and Selection

Engineers combined superior material selection with mechanical CAD/CAM designs to create stamped & formed contacts that exceed the demands of today's industrial electrical systems.

To provide exceptional durability, performance, corrosion, and oxidation resistance, contacts are made from copper alloys, finished with nickel, tin, or gold plating. To provide resistance to crimp relaxation and displacement of metal, the contacts are designed with the conductor wings formed in the direction of the crimp to achieve gas tight crimps that eliminate the need for solder.

#### **Stamped & Formed**

Stamped & formed contacts are designed for use where wire termination costs are of primary concern without sacrificing reliability of electrical circuits. The stamped & formed contacts are made on a precision stamping machine using flat strip stock, then a durable and corrosion proof nickel, tin, or optional gold plating is applied.

The stamped & formed style contacts terminate wire from 10 AWG to 22 AWG (6.0 - 0.35mm<sup>2</sup>) and are available in multiple sizes to accommodate a wide range of wire insulation. The specific contact is determined by the outside diameter of wire insulation and conductor size.



In keeping with the commitment to total quality, all stamped & formed contacts are manufactured using statistical process controls and are subjected to extensive rigorous testing programs, in the lab and in actual field performance.



## ■ 1.3 mm Contact (AMPSEAL) Performance Specifications

### Durability

TE Spec 109-27. Mate and unmate specimens for 10 cycles at maximum rate of 600 cycles per hour. See *note*.

### Current Rating

Up to 17 amps gold, up to 8 amps tin, consult TE product document 108-1329.

### Contact Retention

TE Spec 109-30. Apply an axial load of 115 N to contacts in the axial direction with wedge lock in locked position. Contacts shall not dislodge.

### Crimp Tensile Strength

Contact Size	Tensile Strength
Size 20	80 lbs
Size 18	90 lbs
Size 16	150 lbs

Note: Shall meet visual requirements, show no physical damage and shall meet requirements of additional tests as specified in Test Sequence in Figure 3 of TE product document 108-1329.

## ■ HDSF 1.58 mm Contact (AMPSEAL 16) Performance Specifications

### Durability

SAE J2030 6.11. 50 cycles. See *note*.

### Current Rating

Up to 13 amps, consult TE product document 108-2184.

### Crimp Tensile Strength

USCAR 21 @ 50mm/min

Wire Gauge	Tensile Strength
18 AWG	90 N Min
16 AWG	120 N Min
14 AWG	180 N Min

### Contact Retention

IEC 512-8, Test 51a. Apply axial load of 111 N to contacts at a maximum rate of 10 N per second (or 50mm per minute) and hold for 10 seconds. Contacts shall not dislodge.

### Voltage Drop

Contact Size	Test Current Amps	Voltage Drop (millivolts max)
18	8	100
16	10	100
14	13	100

Note: Shall meet visual requirements, show no physical damage, and meet requirements of additional tests as specified in the Product Qualification and Requalification Test Sequence in Figure 3 of TE product document 108-2184. USCAR is a trademark.

# Contacts

## ■ DEUTSCH Contact Performance Specifications

### Durability

No electrical or mechanical defects after 100 cycles of engagement and disengagement.

### Current Rating (Contact current rating @ 125° C continuous)

Contact Size	Max. Current
Size 20	7.5 amps
Size 16	13 amps
Size 12	25 amps
Size 8	60 amps
Size 4	100 amps

### Contact Retention (Solid and Stamped & Formed)

Contacts withstand a minimum load of:

20 lbs (89 N) for size 20
25 lbs (111 N) for size 16
30 lbs (133 N) for size 12
35 lbs (156 N) for size 8
35 lbs (156 N) for size 4

### Contact Millivolt Drop

Contact Size	Test Current Amps	Millivolt Drop* Solids	Millivolt Drop* S&F
20	7.5	60	100
16	13	60	100
12	25	60	100
8	60	60	N/A
4	100	60	N/A

\*Less drop through wire

### Crimp Tensile Strength (Solid)

Contact Size	Tensile Strength
Size 20	20 lbs
Size 16	25 lbs
Size 12	70 lbs
Size 8	90 lbs
Size 4	300 lbs

### Crimp Tensile Strength (Stamped & Formed)

Contact Size	Tensile Strength
Size 20	20 lbs
Size 16	25 lbs
Size 12	70 lbs



*A crimp tensile test easily and rapidly identifies a proper crimp.*



## ■ Typical Wire Insulation Ranges

(measured in diameter inches)

Wire Gauge	TXL	GXL	SXL
20	.065-.072	.080-.087	.092-.099
18	.073-.084	.089-.098	.103-.110
16	.082-.091	.097-.107	.116-.123
14	.098-.105	.114-.122	.138-.145
12	.120-.128	.137-.146	.159-.168
10	.146-.157	.170-.185	.190-.196
8	.178-.185	.209-.221	.222-.236
6	N/A	N/A	.287-.294

Dimensions are for reference only.



## ■ Wire Sealing Ranges

Dimensions are for reference only.

### AMPSEAL Rear Grommet Sealing Ranges

Contact Size	Standard Seal
1.3 mm 16-20 AWG (1.5-0.5mm <sup>2</sup> )	.067-.106 (1.7-2.7)

### AMPSEAL 16 Rear Grommet Sealing Ranges

Contact Size	Standard Seal	Reduced Diameter Seal
16 14-20 AWG (2.0-0.5mm <sup>2</sup> )	.086-.144 (2.18-3.67)	.051-.100 (1.30-2.54)

### AEC, DRB, DRC, HD30, HDP20 Series Rear Grommet Sealing Ranges

Contact Size	Standard/ Normal Seal N-Seal	Thin Seal T-Seal	T-Seal Modified*	Extra Thin Seal E-Seal	E-Seal Modified*
20 16-22 AWG (1.0-0.35mm <sup>2</sup> )	.040-.095 (1.02-2.41)	.040-.095 (1.02-2.41)	N/A	.040-.095 (1.02-2.41)	.040-.083 (1.01-2.10)
16 14-20 AWG (2.0-0.5mm <sup>2</sup> )	.100-.134 (2.54-3.40)	.088-.134 (2.23-3.40)	.088-.106 (2.24-2.69)	.053-.120 (1.35-3.05)	.053-.103 (1.35-2.62)
12 10-14 AWG (5.0-2.0mm <sup>2</sup> )	.134-.170 (3.40-4.32)	.113-.170 (2.87-4.32)	N/A	.097-.158 (2.46-4.01)	.097-.158 (2.46-4.01)
8 8-10 AWG (8.0-5.0mm <sup>2</sup> )	.190-.240 (4.83-6.10)	.170-.240 (4.32-6.10)	N/A	.135-.220 (3.43-5.59)	N/A
4 6 AWG (13.0mm <sup>2</sup> )	.280-.292 (7.11-7.42)	.261-.292 (6.63-7.42)	N/A	.261-.292 (6.63-7.42)	N/A
4 4 AWG (25.0-21.0mm <sup>2</sup> )	.311-.420 (7.90-10.67)	N/A	N/A	N/A	N/A

\*DEUTSCH cavity arrangements 24-29, 24-47, and 24-31 are only available with the modified seals. Arrangement 24-31 Modified E Seal = .053-.106. Please see drawings 0425-016-0000 and 0425-021-0000 for full specifications.

### DT, DTM, DTP Series Rear Grommet Sealing Ranges

Contact Size	Standard Seal	Extra Thin Seal E-Seal
20 16-22 AWG (1.0-0.35mm <sup>2</sup> )	.053-.120 (1.35-3.05)	N/A
16 14-20 AWG (2.0-0.5mm <sup>2</sup> )	.088-.145 (2.23-3.68)	.053-.120 (1.35-3.05)
12 10-14 AWG (5.0-2.0mm <sup>2</sup> )	.134-.170 (3.40-4.32)	.097-.158 (2.46-4.01)

### STRIKE Series Rear Grommet Sealing Ranges

Contact Size	Standard Seal
20 16-22 AWG (1.0-0.35mm <sup>2</sup> )	.061-.095 (1.55-2.41)
16 14-20 AWG (2.0-0.5mm <sup>2</sup> )	.061-.120 (1.55-3.05)

### HD10 Series Rear Grommet Sealing Ranges

Contact Size	Standard Seal	Extra Thin Seal E-Seal
16 14-20 AWG (2.0-0.5mm <sup>2</sup> )	.100-.150 (2.54-3.81)	.053-.120 (1.35-3.05)
12 10-14 AWG (5.0-2.0mm <sup>2</sup> )	.134-.170 (3.40-4.32)	N/A
4 6 AWG (13.0mm <sup>2</sup> )	.280-.292 (7.11-7.42)	N/A



Proper wire outside diameters help provide water tight seals.

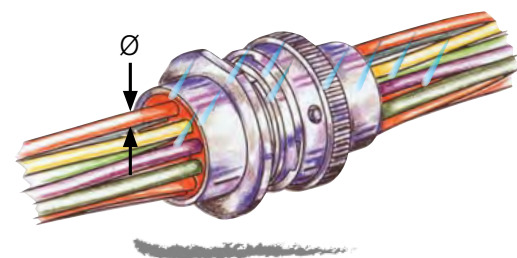

# Contacts

## ■ Solid Contacts

### Solid Contacts - DEUTSCH

Size	Solid Contact Part Numbers		Wire Size AWG (mm <sup>2</sup> )	Recom- mended Strip Length Inches (mm)	Min. Contact Reten- tion	Ref Crimp Tensile Lbs. (N)	Max Rated Amps at 125° Con- tinuous
	Pin	Socket					
20	0460-202-20**	0462-201-20**	20 (0.50)	.156-.218 (3.96-5.54)	20 (89)	20 (89)	7.5
20	0460-010-20**	0462-005-20**	16-18 (1.0-0.75)	.156-.218 (3.96-5.54)	20 (89)	20 (89)	7.5
16	0460-202-16**	0462-201-16**	16-20 (1.5-0.50)	.250-.312 (6.35-7.92)	25 (111)	35-20 (156-89)	13
16	0460-215-16**	0462-209-16**	14 (2.0)	.250-.312 (6.35-7.92)	25 (111)	70 (311)	13
12	0460-204-12**	0462-203-12**	12-14 (3.0-2.0)	.222-.284 (5.64-7.21)	30 (134)	75-70 (334-311)	25
8	0460-204-08**	0462-203-08**	8-10 (10.0-5.0)	.430-.492 (10.92-12.50)	35 (156)	125-90 (556-400)	60
4	0460-204-04**	0462-203-04**	6 (16.0-13.0)	.430-.492 (10.92-12.50)	35 (156)	300 (1334)	100

\*\* = Plating Codes. Contact your representative for custom finish needs.

### Solid Contacts - C038 Modification

Size	Solid Contact Part Numbers		Wire Size AWG (mm <sup>2</sup> )	Recom- mended Strip Length Inches (mm)	Min. Contact Reten- tion	Ref Crimp Tensile Lbs. (N)	Max Rated Amps at 125° Con- tinuous
	Pin	Socket					
4	5960-203-04141	5962-203-04141	4 (25.0-21.0)	.430-.492 (10.92-12.50)	35 (156)	300 (1334)	100

### Solid Contact Plating Codes

Part Number Suffix (**)	Material
31	Gold
90	Nickel (Size 4 pin only)
141	Nickel



### Notice

See information drawing 0425-015-0000. Contact your representative for alternate finishes.

## ■ Stamped & Formed Contacts

### Stamped & Formed Receptacles - 1.3 mm AMPSEAL

Size	Receptacles Part Numbers				Wire Size AWG (mm <sup>2</sup> )	Insulation Diameter (mm)	Finish
	Strip Form	Package Quantity	Loose Piece	Package Quantity			
1.3 mm	770520-1	5000	770854-1	1000	16-20 (1.5-0.5)	.067-.106 (1.7-2.7)	Pre-tin plated
	770520-3	5000	770854-3	1000			Selective gold plated

**Stamped & Formed Pins - HDSF 1.58 mm AMPSEAL 16**

Size	Part Numbers				Wire Size AWG (mm <sup>2</sup> )	Insulation Diameter (mm)	Wire Insulation Support	Finish
	Strip Form	Package Qty	Loose Piece	Package Qty				
HDSF 16 1.58 mm	1924463-1	4000	1924579-1	1000	18-20 (0.8-0.5)	.107-.05 (2.72-1.27)	yes	Gold
	1924463-3	4000	1924579-3	1000				Nickel
	776349-1	4000	-	-	18-20 (0.8-0.5)	.131-.089 (3.33-2.26)	yes	Gold
	776349-3	4000	-	-				Nickel
	638078-1	4000	776300-1	1000	14-18 (2.0-0.8)	.131-.089 (3.33-2.26)	yes	Gold
	638078-3	4000	776300-2	1000				Nickel
	638112-1	4000	776298-1	1000	14-18 (2.0-0.8)	.155-0.077 (3.94-1.96)	no	Gold
	638112-3	4000	776298-2	1000				Nickel
	2098250-1	4000	-	-	18 (1.5-0.8)	.118-.065 (3.00-1.65)	yes	Gold
	2098250-3	4000	-	-				Nickel
	2098252-1	4000	-	-	14 (2.0-1.5)	.128-.083 (3.25-2.10)	yes	Gold
	2098252-3	4000	-	-				Nickel

**Stamped & Formed Receptacles - HDSF 1.58 mm AMPSEAL 16**

Size	Part Numbers				Wire Size AWG (mm <sup>2</sup> )	Insulation Diameter (mm)	Wire Insulation Support	Finish
	Strip Form	Package Qty	Loose Piece	Package Qty				
HDSF 16 1.58 mm	1924464-1	4000	1924580-1	1000	18-20 (0.8-0.5)	.107-.05 (2.72-1.27)	yes	Gold
	1924464-2	4000	1924580-2	1000				Nickel
	776493-1	4000	-	-	18-20 (0.8-0.5)	.131-.089 (3.33-2.26)	yes	Gold
	776493-2	4000	-	-				Nickel
	776492-1	4000	776299-1	1000	14-18 (2.0-0.8)	.131-.089 (3.33-2.26)	yes	Gold
	776492-2	4000	776299-2	1000				Nickel
	776491-1	4000	776297-1	1000	14-18 (2.0-0.8)	.155-.077 (3.94-1.96)	no	Gold
	776491-2	4000	776297-2	1000				Nickel
	2098251-1	4000	-	-	18 (1.5-0.8)	.118-.065 (3.00-1.65)	yes	Gold
	2098251-2	4000	-	-				Nickel
	2098253-1	4000	-	-	14 (2.0-1.5)	.128-.083 (3.25-2.10)	yes	Gold
	2098253-2	4000	-	-				Nickel

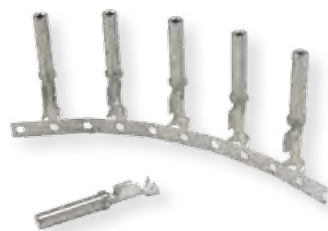

# Contacts

## Stamped & Formed Contacts- DEUTSCH

Size	Stamped & Formed Contact Part Numbers		Carrier Strip Identification	Wire Size AWG (mm <sup>2</sup> )	Wire Insulation O.D. Range	Recommended Strip Length Inches (mm)	Min. Contact Retention	Max Rated Amps at 125° Continuous
	Pin	Socket						
20	1060-20-01**	1062-20-01**	20-01	16-22 (1.5-0.35)	.075-.125 (1.91-3.18)	.150-.200 (3.81-5.08)	20 (89)	7.5
20	1060-20-02**	1062-20-02**	20-02	16-22 (1.5-0.35)	.051-.085 (1.30-2.16)	.150-.200 (3.81-5.08)	20 (89)	7.5
20	N/A	1062-20-03** sleeveless	20-03	16-22 (1.5-0.35)	.075-.125 (1.91-3.18)	.150-.200 (3.81-5.08)	20 (89)	7.5
20	1060-20-06**	1062-20-06**	20-06	14-16 (2.5-1.0)	.075-.125 (1.91-3.18)	.150-.200 (3.81-5.08)	20 (89)	7.5
16	1060-14-01**	1062-14-01**	14-16	14-18 (2.0-.75)	.095-.150 (2.41-3.81)	.150-.200 (3.81-5.08)	25 (111)	13
16	1060-14-10**	1062-14-10**	14-16	14-18 (2.0-.75)	.095-.150 (2.41-3.81)	.150-.200 (3.81-5.08)	25 (111)	13
16	1060-16-01**	1062-16-01**	16-18	14-18 (2.0-.75)	.075-.140 (1.90-3.55)	.150-.200 (3.81-5.08)	25 (111)	13
16	1060-16-06**	1062-16-06**	0.5-1.0	16-20 (1.0-.50)	.055-.100 (1.40-2.54)	.150-.200 (3.81-5.08)	25 (111)	13
16	1060-16-09**	1062-16-09**	16-18	14-18 (2.0-.75)	.075-.140 (1.90-3.55)	.150-.200 (3.81-5.08)	25 (111)	13
16	1060-16-12**	1062-16-12**	1.0-2.5	12-16 (2.5-1.0)	.075-.140 (1.90-3.55)	.175-.225 (4.45-5.72)	25 (111)	13
16	N/A	1062-16-14** sleeveless	14-16	12-16 (2.5-1.0)	.075-.140 (1.90-3.55)	.175-.225 (4.45-5.72)	25 (111)	13
12	1060-12-01**	1062-12-01**	12-14	12-14 (4.0-2.0)	.113-.176 (2.87-4.47)	.225-.275 (5.72-6.99)	30 (134)	25
12	1060-12-02**	1062-12-02**	10-12	10† (6.0-4.0)	.140-.204 (3.56-5.18)	.225-.275 (5.72-6.99)	30 (134)	25

\*\* = Plating Codes. Contact your representative for custom finish needs.

† = TXL wire insulation is preferred

### Notice

See information drawing 0425-015-0000. Contact your representative for alternate finishes.

### S&F Contact Plating Codes

Part Number Suffix (**)	Material
22	Nickel
44	Gold
66	Tin/Nickel
77	Tin
88	Selective Gold



## PCB Pins

Straight reduced diameter extended pins are available for installation in the DEUTSCH family of connectors. The use of removable contacts provides design flexibility and a low cost alternative to meet application needs. These solid copper alloy pins may be specified in various platings and assembled in HD30, HDP20, HD10, DRC, or DT receptacles.



### Material

Copper alloy

### Plating Codes

31: Gold

90: Tin

141: Nickel

### PCB Mounting

Consult factory for PCB mounting details and pin positions.

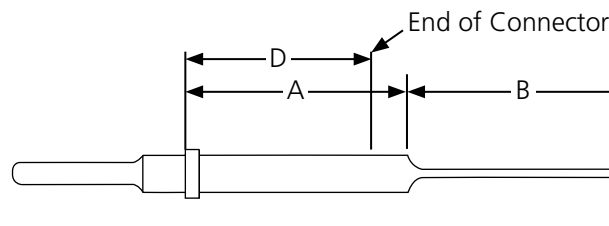

*Notice*

See information drawing 0425-202-0000 for full specifications.

Contact Size	Part Number	A	B	C
20	0460-208-2031	1.305 (33.15)	.248 (6.30)	.025 (.64)
	0460-208-2090	1.305 (33.15)	.248 (6.30)	.025 (.64)
16	0460-208-16141	1.300 (33.02)	.248 (6.30)	.025 (.64)
	0460-208-1631	1.300 (33.02)	.248 (6.30)	.025 (.64)
	0460-229-16141	.545 (13.84)	.248 (6.30)	.025 (.64)
	0460-241-16141	1.305 (33.15)	.160 (4.06)	.040 (1.02)
	0460-244-16141	.976 (24.79)	.400 (10.16)	.041 (1.04)
	0460-244-1631	.976 (24.79)	.400 (10.16)	.041 (1.04)
12	0460-208-12141	1.305 (33.15)	.248 (6.30)	.025 (.64)
	0460-245-1231	1.024 (26.01)	.500 (12.70)	.041 (1.04)
	0460-245-1290	1.024 (26.01)	.500 (12.70)	.041 (1.04)

Series	D*
HD30/HDP20	.939 (23.85)
HD10	.925 (23.50)
DT	.777 (19.74)
DT04-2P	.677 (17.20)
DT04-3P	.677 (17.20)
DRC	1.063 (27.00)

\*D is equal to the distance from the contact shoulder to the end of the connector.

Dimensions are for reference only.



**HD10 Series**



**HDP20 Series**



**HD30 Series**

## Crimping

Crimping is defined as the act of joining a conductor to a pin or socket contact using a mechanical tool to compress and displace metal. In a good crimp joint, there is a mutual flow of metal, causing a symmetrical distortion of wire strands and contact material. A proper crimp will establish mechanical strength and excellent electrical conductivity.

### ■ Crimping Configurations

Stamped & formed contacts use a folded type of crimp (Fig. 1) while solid contacts use a 1, 2, or 4 indent crimp (Fig. 2). In both styles of crimps, the wire strands and the contact material are formed together in a solid mass creating a reduction of the wire strands area. The reduced wire strand area creates a minimum of voids allowing for excellent conductivity. Crimping may be accomplished with hand tools or power tools.

#### Stamped & Formed Style



Cross-Section Across Axis

Figure 1

#### Solid Style



Indenter Crimp  
Cross-Section Across Axis

Figure 2

### ■ Benefits of Crimped Contacts

Mechanically crimping contacts is the dominant wire termination method, for some very good reasons:

1. With smaller wire, the crimp is as strong as the wire itself.
2. The joint can be visually inspected. Viewing the wire through an inspection hole in the contact makes inspection quick and easy, both by the operator and by the inspector.
3. Plating thickness is not restricted, as in solder joints, so better corrosion resistance and contact reliability are achieved.
4. Crimping can be done anywhere, without special preparation. Terminations are replaced or modified in the field exactly the same as in the shop, using the same tools and the same techniques, and with the same ease of operation and certainty of results.
5. Total installed and maintenance costs are lower.



*Solder should not be added to DEUTSCH terminals.*



#### Notice

The use of dielectric grease is not recommended.

## ■ Crimp Inspection

Crimping tools provide lower total installation and maintenance costs. However, controls are required to help ensure that the proper crimp tools designed for the type and size contact are used, the pin or socket is properly inserted into the tool, the wire insulation is stripped properly, and the wire fully inserts into the contact.

When a crimp is completed, correct termination can be visually inspected. The inspector should check for:

- The removed insulation should expose a conductor length that will pass beyond the inspection hole in the contact and still reveal the appropriate length of conductor between the contact and the insulation on the wire.
- Wire strands intact.
- All wire strands enter the contact barrel.
- Wire inserted to the proper depth in the contact.

When the correct crimp tool and process are used, a good termination results.

### *Notice*

For more detailed crimp dimensions please request a drawing.

## ■ Solid Contact Crimp

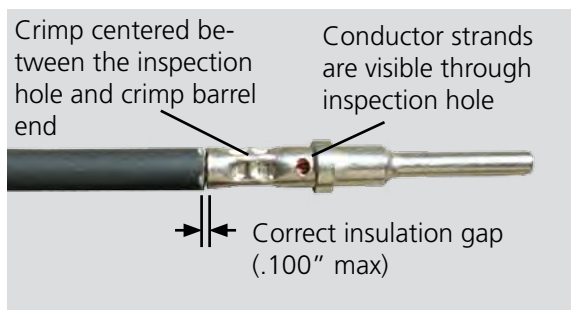

**Acceptable Crimp**

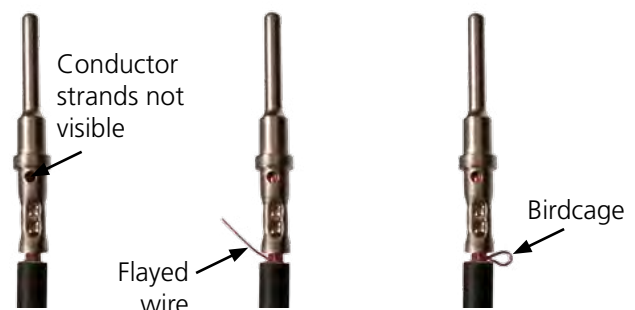

**Unacceptable Crimps**

## ■ Stamped & Formed Contact Crimp

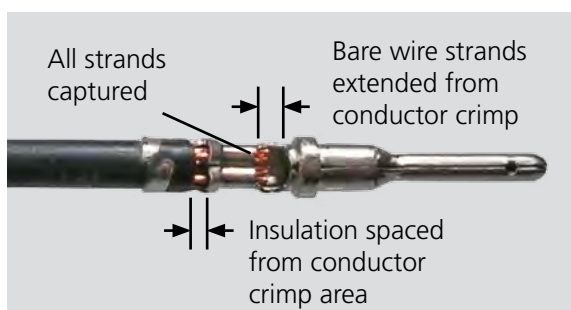

**Acceptable Crimp**

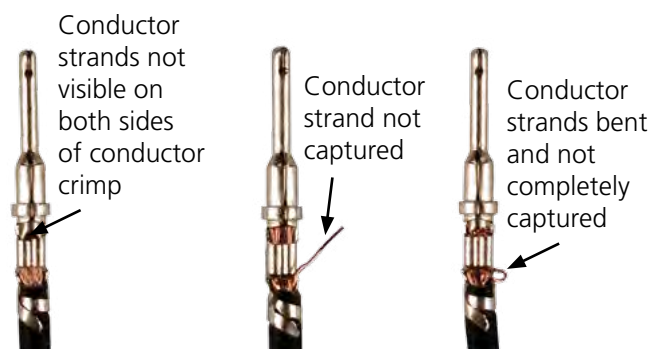

**Unacceptable Crimps**

## Accessories

Additional accessories are available to aid in the design flexibility and sealing requirements of applications. Accessory items such as keying pins and sealing plugs assist in maintaining an environmental seal and preventing mis-mating.

### ■ Keying Pins

Keying pins are solid plastic rods used to help prevent mis-mating of like connectors in close proximity. Applicable DEUTSCH product lines include HD10, HD30, HDP20, DT, and DTM Series.

Keying pins are inserted into the retention fingers of an empty socket cavity. Once installed, the keying pin blocks a mating contact pin from being inserted. The contact pin will be blocked before the coupling device mates the connectors, preventing the mis-mating of like connectors. Proper usage requires that the corresponding mating pin be omitted and a sealing plug is inserted in the rear cavity of the mating connector. Individual applications will vary, and testing should be done to determine the best pattern arrangement to prevent improper connector mating.



Part Number	Contact Size	Color
0413-216-2005	20	Red
0413-215-1605	16	White
0413-214-1205	12	Yellow

#### *Notice*

Multiple keying pins may be required to prevent unintentional forced mating.

### ■ Contact Crimp Sleeve Reducer

A crimp sleeve reducer is available to allow DEUTSCH size 4 solid contacts to accept 8-10 AWG wire. When populating a connector using a contact with a reducer sleeve, be sure the insert seal penetrates the rear grommet. The use of the crimp sleeve reducer requires no extra crimp tools and provides an easy transition and increased flexibility.



Insert Seal  
0410-241-0406



Crimp Sleeve  
0421-203-04141









#### *Notice*

TXL wire insulation with 10 AWG wire is not recommended because it may not provide an environmental seal against the insert seal.

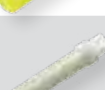

## ■ Sealing Plugs

Open cavities provide pathways for contaminants to enter the connectors. To maintain seal integrity, any unused cavity must be filled with the appropriate size sealing plug.

Sealing Plug	Part Number	Contact Size	Wire Gauge Range	Description
	114019	Size 4	4-6 AWG	silicone rubber, used with DEUTSCH contacts
	114018	Size 8	8-10 AWG	thermoplastic, used with DEUTSCH contacts
	114017	Size 12, 16	12-20 AWG	thermoplastic, used with DEUTSCH contacts
	0413-217-1605 (locking sealing plug)	Size 16	14-20 AWG	thermoplastic, used with DEUTSCH contacts, retained by locking fingers
	0413-003-1605	Size 16	14-20 AWG	thermoplastic, used with STRIKE Series
	770678-1	1.3 mm	16-20 AWG	nylon, used with AMPSEAL
	776363-1	1.58 mm	16-20 AWG	PBT, used with AMPSEAL 16 (standard diameter cavities)
	776364-1	Size 20	16-20 AWG	PBT, used with AMPSEAL 16 (reduced diameter cavities)
	0413-204-2005	Size 20	20 AWG	thermoplastic, used with DEUTSCH contacts



*Sealing plugs are used to seal the connector when all the cavities are not used by wires.*

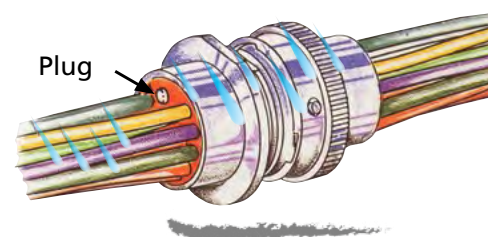

## How To Instructions

### ■ Sealing Plug Installation

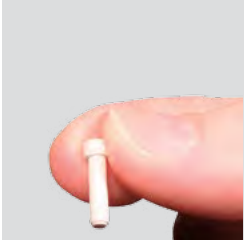

**Step 1:**  
Holding the sealing plug with large diameter end away from the connector, gently apply downward pressure to force the sealing plug into the cavity.



**Step 2:**  
With perpendicular motion, apply downward pressure to the large diameter end of the sealing plug.



**Step 3:**  
Apply pressure until sealing plug is forced to stop by contact with rear grommet. Visually inspect the sealing plug to confirm it is flush with cavity opening.

### ■ Locking Sealing Plug Installation

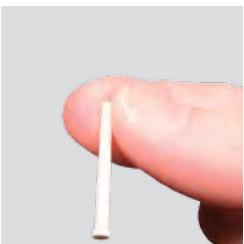

**Step 1:**  
Holding the sealing plug with large diameter end towards the connector, gently apply downward pressure to force the sealing plug into the cavity.



**Step 2:**  
With perpendicular motion, apply downward pressure to the small diameter end of the sealing plug.



**Step 3:**  
Apply pressure until sealing plug locks into place. A slight tug on the sealing plug will confirm it is locked into place.

### ■ Contact Crimp Sleeve Reducer Assembly



**Step 1:**  
Place crimp sleeve reducer into contact barrel.



**Step 2:**  
Slide insert seal onto 8-10 AWG wire stopping just at the edge of the stripped insulation.



**Step 3:**  
Insert wire into barrel of contact and crimp using designated tooling.



**Step 4:**  
Ensure seal is not distorted.



# Tooling

## Contents

Tooling Overview	130
Benefits of Crimping	130
Crimp Inspection	130
Automated Tooling	131-133
Hand Tools	134-135
Removal Tools	135-136
How To Instructions	137--139

## Tooling Overview

There are two types of contacts manufactured, solid and stamped & formed. Both styles of contacts are designed for crimp style terminations - no solder is required or recommended. A crimp style termination displaces the wire strands creating a superior bond between the wire and the contact.

Several types of tools are available to assist with hand and production wire crimping, wire insertion and removal and wedgelock/terminal position assurance removal. The tools are specific to the solid contacts or the stamped & formed contacts. To create a proper crimp and achieve the highest performance specifications, contacts must be crimped with the recommended tooling.

### ■ Benefits of Crimping

Mechanically crimping contacts is the dominant wire termination method, for some very good reasons:

1. Since no wet process is involved, corrosion is not a problem. No adhesive, flux, or additives are used.
2. Strength, accuracy and overall reliability of a crimped contact are controlled by the crimp tool, not the operator. The field tools (except size 4 solid style) release the contact only after the full crimping cycle is completed.
3. The crimp tool is universal, accepts both pins and sockets of many sizes.
4. Crimping can be done anywhere, without special preparation. Terminations are replaced or modified in the field exactly the same as in the shop, using the same tools and the same techniques, and with the same ease of operation and certainty of results.
5. Total installed and maintenance costs are lower.

### ■ Solid Contact Crimp Inspection

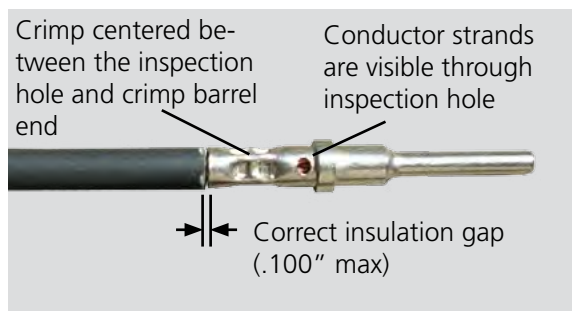

Acceptable Crimp

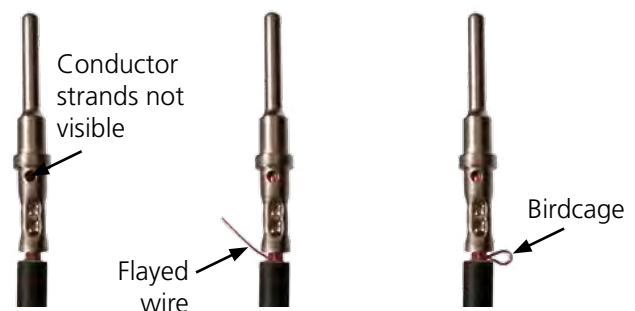

Unacceptable Crimps

### ■ Stamped & Formed Contact Crimp Inspection

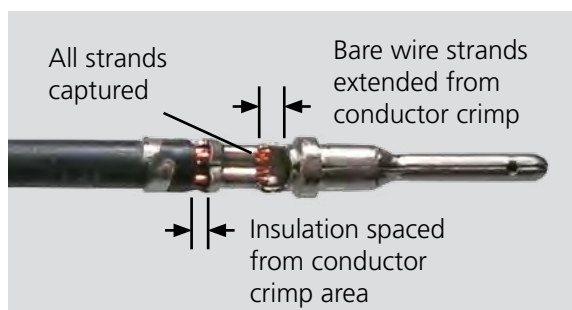

Acceptable Crimp

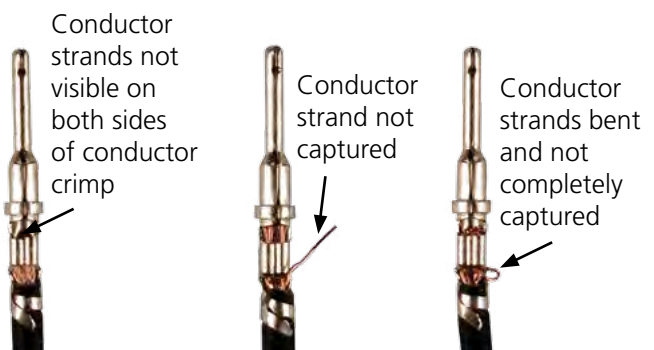

Unacceptable Crimps

## Automated Tooling Overview

For higher production volumes, a pneumatic power crimp tool is available for the solid contacts, and applicator dies for stamped & formed contacts. The HDP-400, the pneumatic solid crimp tool, is a fast, bench-top tool that crimps most DEUTSCH contacts. The HDP-400 has a foot control, and easy-to-change dies and locators for each contact size. TE Connectivity's stamped & formed OCEAN applicator dies are heavy duty mini-dies that work in many industry standard presses. The OCEAN applicator dies offer simple adjustments and the flexibility to accept different sized contacts and wire gauge.

### Automated Tooling for Solid Contacts



Tool P/N	Contact Size	Contact Part Number
HDP-400	4	0460-204-0490
		0462-203-04141
	8	0460-204-08141
		0462-203-08141
	12	0460-204-12**
		0462-203-12**
	16	0460-202-16**
		0462-201-16**
		0460-215-16**
		0462-209-16**
20	0460-202-20**	
	0462-201-20**	



### HDP-400 Dies and Locators

Crimp Tool Part Number	Drawing Number Reference
HDP-400	0425-205-0000

### HDP-400 Tooling Accessories



### Go-No-Go Gauges

Part Number	Go-No-Go Gauges
GA20N	HDP-400 Size 20
450GA-16N	HDP-400 Size 16
450GA-12N	HDP-400 Size 12
GA8-SPEC	HDP-400 Size 8
450GA-4-SPEC	HDP-400 Size 4

# Tooling

## ■ Automated Tooling for Stamped & Formed Contacts

### Applicator Tooling - 1.3 mm Contacts (AMPSEAL)

	Socket P/N	Insulation Range O.D. (mm)	Applicator P/N
1.3 mm	770520-1 770520-3	.067-.106 (1.70-2.70)	2151376-1

The -1 suffix on the applicator p/n represents a mechanical feed, for other feed options or additional information contact your representative.



### Applicator Tooling - HDSF 1.58 mm Contacts (AMPSEAL 16)

	Pin P/N	Receptacle P/N	Insulation Range O.D. (mm)	Applicator P/N
HDSF 1.58 mm	2098250-1 2098250-3	2098251-1	.065-.118 (1.65-3.0)	2151617-1
	-	2098251-2	.065-.118 (1.65-3.0)	2151617-2
	638112-1 638112-3	-	.077-.155 (1.96-3.94)	2151239-1
	-	776491-1 776491-2	.077-.155 (1.96-3.94)	2151239-2

The -1 suffix on the applicator p/n represents a mechanical feed and the -2 suffix represents a pneumatic feed, for other feed options or additional information contact your representative.

### Applicator Tooling - DEUTSCH Contacts

	Pin P/N	Socket P/N	Insulation Range O.D. (mm)	Applicator P/N Conversion Kit P/N
Size 12 - Group 1	1060-12-0144 1060-12-0166	1062-12-0144 1062-12-0166	.151-.176 (3.83-4.47)	2266124-1 7-2266124-8
			.130-.154 (3.30-3.91)	2266125-1 7-2266125-8
			.113-.135 (2.87-3.43)	2266126-1 7-2266126-8
Size 12 - Group 2	1060-12-0222 1060-12-0244	1062-12-0222 1062-12-0244	.185-.204 (4.70-5.18)	2266127-1 7-2266127-8
			.155-.190 (3.94-4.83)	2266128-1 7-2266128-8
			.140-.160 (3.56-4.06)	2266129-1 7-226129-8

The -1 suffix on the applicator p/n represents a mechanical feed, for other feed options contact your representative. The conversion kit is to convert applicators within the same group. For more information, please reference TE catalog 1-1773730-8 or contact your representative.

## Applicator Tooling - DEUTSCH Contacts (continued)

	Pin P/N	Socket P/N	Insulation Range O.D. (mm)	Applicator P/N Conversion Kit P/N
Size 16 - Group 1	1060-14-0122	1062-14-0122	.120-.150 (3.05-3.81)	2266100-1
	1060-14-0144	1062-14-0144		7-2266100-8
	1060-14-0177	1062-14-0177		
	1060-14-1077	1062-14-1077	.105-.125 (2.67-3.18)	2266101-1
	1060-14-1088	1062-14-1088		7-2266101-8
	1060-16-0122	1062-16-0122	.105-.125 (2.67-3.18)	2266101-1
	1060-16-0144	1062-16-0144		7-2266101-8
	1060-16-0177	1062-16-0177		
	1060-16-0722	1062-16-0722	.085-.111 (2.16-2.82)	2266102-1
	1060-16-0744	1062-16-0744		7-2266102-8
	1060-16-0777	1062-16-0777	.075-.105 (1.91-2.67)	2266103-1
	1060-16-0977	1062-16-0977		7-2266103-8
1060-16-0988	1062-16-0988			
Size 16 - Group 2	1060-16-0622	1062-16-0622	.063-.094 (1.60-2.39)	2266110-1
	1060-16-0644	1062-16-0644		7-2266110-8
	1060-16-0677	1062-16-0677	.050-.075 (1.27-1.91)	2266111-1
	1060-16-0688	1062-16-0688		7-2266111-8
Size 16 - Group 3	1060-16-1222	1062-16-1222	.120-.140 (3.05-3.56)	2266112-1
	1060-16-1244	1062-16-1244		7-2266112-8
	1060-16-1277	1062-16-1277	.105-.125 (2.67-3.18)	2266113-1
	-	1062-16-1422		7-2266113-8
	-	1062-16-1444		2266114-1
	-	1062-16-1477	7-2266114-8	
Size 20 - Group 1	1060-20-0122	1062-20-0122	.105-.125 (2.67-3.18)	2266116-1
	1060-20-0144	1062-20-0144		7-2266116-8
	1060-20-0177	1062-20-0177	.085-.111 (2.16-2.82)	2266117-1
	-	1062-20-0322		7-2266117-8
	-	1062-20-0344		2266118-1
	-	1062-20-0377	7-2266118-8	
	1060-20-0222	1062-20-0222	.063-.085 (1.62-2.16)	2266119-1
	1060-20-0244	1062-20-0244		7-2266119-8
	1060-20-0277	1062-20-0277		2266120-1
			.050-.075 (1.27-1.91)	7-2266120-8

The -1 suffix on the applicator p/n represents a mechanical feed, for other feed options contact your representative. The conversion kit is to convert applicators within the same group. For more information, please reference TE catalog 1-1773730-8 or contact your representative.

## Hand Tool Overview

For field service, prototype, and low-volume production, there are several easy-to-use hand crimp tools for both solid barrel and stamped & formed contacts. All hand crimp tools provide a tight, complete crimp with minimal effort. The HDT-48-00, the most commonly used tool for solid contacts, crimps a wide range of contact sizes. It provides a symmetrical four indent crimp, is compact and easy-to-use for field service, yet sturdy and reliable enough for low volume production. Hand crimp tools for DEUTSCH stamped & formed contacts are wire gauge specific and simultaneously crimp the insulation and conductor, saving time and effort during field service. The PRO-CRIMPER III hand tool features interchangeable dies and locators for different AMPSEAL and AMPSEAL 16 stamped & formed contacts.

### Hand Tools for Solid Contacts



HDT-04-08



HDT-48-00



HDT-50-00



HDT-1561

Contact Size	Contact Part Number	Tool Part Number	Crimp Type
4	0460-204-0490	HDT-04-08	Two Indent Crimp
	0462-203-04141		
8	0460-204-08141	HDT-04-08	Two Indent Crimp
	0462-203-08141		
12	0460-204-12** 0462-203-12**	HDT-48-00	Four Indent Crimp
		HDT-1561	Two Indent Crimp
		HDT-50-00	One Indent Crimp
16	0460-202-16** 0462-201-16** 0460-215-16** 0462-209-16**	HDT-48-00	Four Indent Crimp
		HDT-1561	Two Indent Crimp
		HDT-50-00	One Indent Crimp
		HDT-48-00	Four Indent Crimp
20	0460-202-20** 0462-201-20**	HDT-1561	Two Indent Crimp
		HDT-50-00	One Indent Crimp
		HDT-48-00	Four Indent Crimp

### HDT-48-00 Hand Tool Accessories

#### HDT-48-00 Adjustment Screw and Locking Nut



Part Number	Crimp Tool Replacement Part
0426-209-0000	Adjustment Screw and Locking Nut
M2700-395-10	Locking Nut



*Go-no-go gauges are used to inspect crimp tooling. The G454 gauge is used with the HDT-48-00 hand tool.*

#### Go-No-Go Gauge



Part Number	Description
G454	HDT-48-00 Go-No-Go Gauge

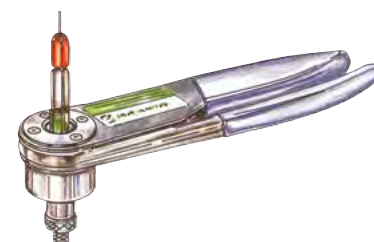



## ■ Hand Tools for DEUTSCH Stamped & Formed Contacts



DTT-12-00



DTT-12-01



DTT-16-00  
DTT-16-01  
DTT-20-00  
DTT-20-02

Contact Size	Contact Part Number	Tool Part Number
12	1060-12-01** 1062-12-01**	DTT-12-00
	1060-12-02** 1062-12-02**	DTT-12-01
16	1060-16-01** 1062-16-01**	DTT-16-00 (14-16 AWG)
	1060-16-06** 1062-16-06**	DTT-16-01 (18 AWG)
20	1060-20-01** 1062-20-01**	DTT-20-00
	1060-20-02** 1062-20-02**	DTT-20-02

## ■ Hand Tools for AMPSEAL and AMPSEAL 16 Stamped & Formed Contacts



Part Number	Wire Size AWG	Description
58529-1	16-20	PRO-CRIMPER III hand tool for AMPSEAL contacts
91337-1	14-18	PRO-CRIMPER III hand tool for AMPSEAL 16 contacts
2119118-1	18-20	PRO-CRIMPER III hand tool for AMPSEAL 16 contacts

## ■ Removal Tools

Tool	Part Number	Description
	776441-1	Tool for PLR (Primary Latch Reinforcement) and contact removal for use with AMPSEAL 16 connectors
	DT-RT1	Multi-use tool with a small hook on one end for wedgelock removal, and a small screwdriver on the other end to push back the locking fingers and release the contact. For use with the DT, DTM, DTP, DTV, DRB, and STRIKE Series.

# Tooling

## ■ Removal Tools

DEUTSCH removal tools are designed to simplify contact removal and field service repair in connectors that utilize a round shoulder contact retention system. Removal tools are compact, easy-to-use, and manufactured of heavy duty plastic to remove contacts without damage to the wire, insulation, connector seals, or connector body. The removal tools are required for wire removal in the DTHD, Jiffy Splices, HD10, HDP20, HD30, DRC, AEC, and WT Series.

Removal Tool	Part Number	Contact Size	Wire Gauge Range	Color
	0411-027-0405	Size 4	4 AWG	Black
	114009	Size 4	6 AWG	White
	114008	Size 8	8-10 AWG	Green
	0411-353-0805	Size 8 for HD Box	8-10 AWG	Green Extended
	114010	Size 12	12 AWG	Yellow
	0411-337-1205	Size 12	12-14 AWG Extra Thin Wall (E-Seal)	Orange
	0411-291-1405	Size 16	14-16 AWG	Green
	0411-310-1605	Size 16	16-20 AWG	Light Blue
	0411-336-1605	Size 16	16-18 AWG Extra Thin Wall (E-Seal)	Dark Blue
	0411-240-2005	Size 20	20-22 AWG	Red



*A contact removal tool taped or tie wrapped to the harness will make it easily available, should repairs be needed.*

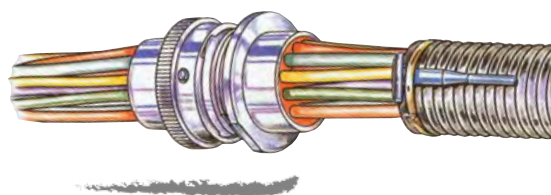

## How To Instructions

### ■ Wire Stripping

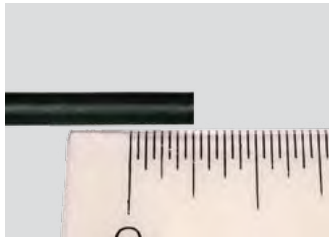

#### Step 1:

1. Choose the correct AWG for the contact being used.
2. Measure from the end of the wire the recommended strip length according to the contact size.
3. Place the wire into a stripping tool at the recommended strip length. Strip the wire according to stripping tool instructions.



#### Step 2:

1. After stripping, a small piece of the insulation should come off.
2. Check for any broken strands or for a dent in the wire. If either exist, the wire is damaged and should be cut and stripped again.



#### Step 3:

1. Measure the exposed strands to be sure the crimp length is correct.



*Leaving the stripped portion of the insulation on the wire until prior to crimping will avoid flayed wire strands.*

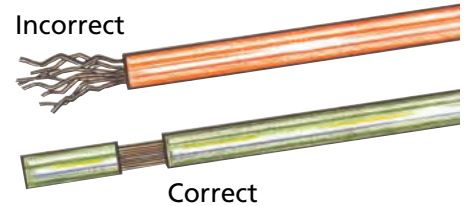

### ■ Crimping with the HDT-48-00 Hand Tool



#### Step 1:

1. Strip insulation from wire.
2. Raise selector knob and rotate until arrow is aligned with wire size to be crimped.
3. Loosen locknut, turn adjusting screw in until it stops.



#### Step 2:

1. Insert contact with barrel up. Turn adjusting screw counterclockwise until contact is flush with indenter cover. Tighten locknut.



#### Step 3:

1. Insert wire into contact. Contact must be centered between indentors. Close handles until crimp cycle is completed.
2. Release handles and remove crimped contact.

#### *Notice*

Tool must be adjusted for each type/size of contact.

## ■ Crimping with DTT Style Hand Tools (size 16 & 20)



**Step 1:**  
Cycle the hand tool to the open position. Place the contact into the correct die nest.

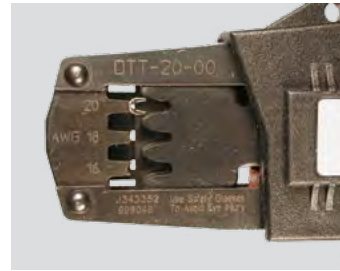

**Step 2:**  
Partially close the tool until the contact is held in place.

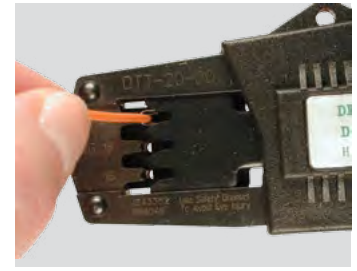

**Step 3:**  
Insert the prestripped wire into the crimp area of the contact.

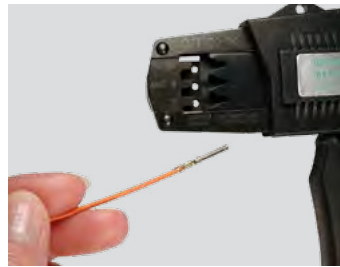

**Step 4:**  
Close the tool until the ratchet releases. The ratchet is released when a loud click is heard and crimp is complete.

## ■ Crimping with DTT-12-01 Hand Tool

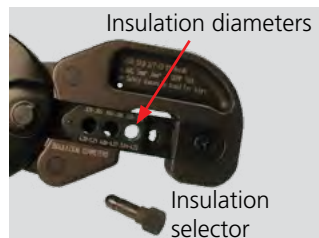

**Step 1:**  
Cycle handles to release ratchet and fully open crimp jaws. Pull out insulation selector and push into proper diameter using the chart below.

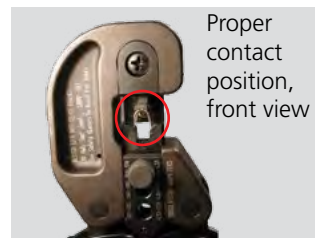

**Step 2:**

1. Insert contact into locator. Adjust alignment and width of crimp wings if necessary to help ensure capture by crimp jaws.
2. Insert stripped wire into the contact. Close crimp tool until full-cycle ratchet control releases.



Wire Type	Insulation Selector
10 TXL	.150-.170
10 GXL	.160-.180
10 SXL	.170-.205
5.0 mm <sup>2</sup>	.160-.180
6.0 mm <sup>2</sup>	.170-.205

## ■ Crimping with DTT-12-00 Hand Tool

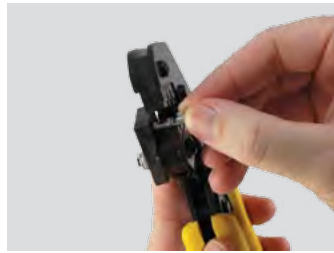

### Step 1:

Cycle the tool to release ratchet and open tool. Lift the locator gate, and place the contact into the correct die nest. Adjust alignment of crimp wings to help ensure capture by crimp jaws.



### Step 2:

Partially close the tool until the contact is held in place.

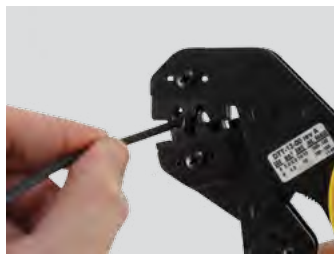

### Step 3:

Insert the prestripped wire into the crimp area of the contact.



### Step 4:

Close the tool until the ratchet releases. The ratchet is released when a loud click is heard and crimp is complete.



# Additional Resources

## Contents

Modification List	142-148
-------------------	---------

---

Requirements & Standards	149
--------------------------	-----

---

Glossary	150-156
----------	---------

---

Index	157-159
-------	---------

---



## Modification List

Mod #	Series	Description
<b>A</b>		
<b>A004</b>	DRC	Receptacle with molded-in PCB pins, 24 and 40 way
<b>A006</b>	DRC	Receptacle with molded-in PCB pins, 40 way, #40 pin removed
<b>B</b>		
<b>B009</b>	HD10	Receptacle with raised key removed from front of flange, no rear threads
<b>B010</b>	HD10	Plug with coupling ring added
<b>B016</b>	DT, DT13/15	Receptacle has extended shell and enhanced keys, plug has enhanced seal retention (P012), 12 way
<b>B019</b>	HD30	Custom snap ring mount
<b>B022</b>	HD10	Receptacle with D-hole panel mount, rear threads, J1939, black
<b>B025</b>	HD10	Receptacle with D-hole panel mount, no rear threads, black
<b>B026</b>	DTMF	PCB receptacle with alternate keying, requires plugs with WM-12S-B026 wedgelocks
<b>B028</b>	DT15	5 P.S.I rating
<b>BE</b>		
<b>BE02</b>	DT	Receptacle with extended shell and enhanced keys (B016), end cap
<b>BE03</b>	DT	Receptacle with extended shell and enhanced keys (B016), end cap, black
<b>BE04</b>	DT	Receptacle with extended shell and enhanced keys (B016), end cap, reduced diameter seals (E seal), black
<b>BE05</b>	DT	Receptacle with extended shell and enhanced keys (B016), end cap, sealed flange, reduced diameter seals (E seal), threaded stainless steel flange inserts
<b>BL</b>		
<b>BL04</b>	DT	Receptacle with extended shell and enhanced keys (B016), welded flange
<b>BL08</b>	DT	Receptacle with extended shell and enhanced keys (B016), welded flange, black
<b>BL10</b>	DT	Receptacle with extended shell and enhanced keys (B016), sealed flange, reduced diameter seals (E seal), shrink boot adapter, threaded stainless steel flange inserts
<b>BL11</b>	DT	Receptacle with extended shell and enhanced keys (B016), sealed flange, reduced diameter seals (E seal), end cap, threaded stainless steel flange inserts



Mod #	Series	Description
<b>BP</b>		
<b>BP03</b>	HD10	Receptacle with D-hole panel mount, J1939 Type II, green
<b>C</b>		
<b>C003</b>	HDN	Standard cavity marking identification
<b>C008</b>	DT	Cavity blocked (C)
<b>C012</b>	HD30	Cavities blocked (J, P)
<b>C015</b>	DT, DTP	Reduced diameter seals (E seal)
<b>C016</b>	HD10	Cavities blocked (H, J) - HD10 Series 9 way
<b>C017</b>	DT, DTM, DTP	Solid rear grommet
<b>C018</b>	HD30	Cavities blocked (11, 18, 19), N/E seal options
<b>C019</b>	HD30	Cavities blocked (1, 2, 8, 9), N/E seal options
<b>C020</b>	HD30	Cavities blocked (A, D), N/E seal options
<b>C021</b>	HD30	Cavities blocked (A, B, C, D)
<b>C022</b>	HD30	Cavities blocked (A, D, J, M), with reduced diameter seals (E seal)
<b>C024</b>	HD10	Cavities blocked (B, C, D)
<b>C026</b>	DRC	Cavities blocked, 50 way
<b>C030</b>	HD30, HDP20	Four size 16 cavities blocked (1, 2, 5, 6)
<b>C038</b>	HD30, HDP20	Three size 4, four size 16, requires special size 4 AWG contacts
<b>C041</b>	HDP20	Receptacle with diagnostic keying
<b>CE</b>		
<b>CE01</b>	DT	Reduced diameter seals (E seal), end cap
<b>CE02</b>	DT, DTP	Reduced diameter seals (E seal), black
<b>CE03</b>	DT	Reduced diameter seals (E seal), end cap, black
<b>CE04</b>	DT	Reduced diameter seals (E seal), shrink boot adapter
<b>CE05</b>	DT	Plug with reduced diameter seals (E seal), enhanced seal retention (P012), end cap
<b>CE06</b>	DT	Plug with reduced diameter seals (E seal), enhanced seal retention (P012)
<b>CE07</b>	DT	Receptacle with extended shell and enhanced keys (B016), reduced diameter seals (E seal), end cap
<b>CE08</b>	DT	Receptacle with extended shell and enhanced keys (B016), reduced diameter seals (E seal)
<b>CE09</b>	DT	Reduced diameter seals (E seal), shrink boot adapter, black
<b>CE10</b>	DT	Plug with reduced diameter seals (E seal), enhanced seal retention (P012), black
<b>CE11</b>	DT	Plug with reduced diameter seals (E seal), enhanced seal retention (P012), end cap, black
<b>CE12</b>	DT	Plug with reduced diameter seals (E seal), enhanced seal retention (P012), shrink boot adapter, black
<b>CE13</b>	DT	Plug with reduced diameter seals (E seal), enhanced seal retention (P012), shrink boot adapter
<b>CE14</b>	DT	Plug with reduced diameter seals (E seal), enhanced seal retention (P012), latch guard end cap, black

## Additional Resources

Mod #	Series	Description
<b>CL</b>		
CL01	HD30	Cavities blocked (J, Q, R, S, X), adapter for cable clamp (072)
CL03	DT	Reduced diameter seals (E seal), welded flange
CL07	DT	Reduced diameter seals (E seal), sealed flange, shrink boot adapter
CL08	DT	Reduced diameter seals (E seal), welded flange, end cap, disabled latch
CL09	DT	Reduced diameter seals (E seal), sealed flange, end cap, black
CL15	DT	Reduced diameter seals (E seal), welded flange, black
CL20	HDP20	Plug with diagnostic keying
<b>CG</b>		
CG01	DRC	5mm threaded insert with silver plating, molded-in contacts, outside rows gold
<b>CP</b>		
CP01	DT	All cavities plugged, enhanced seal retention (P012), end cap
<b>E</b>		
E003	DT, DTHD, DTM, DTP	End cap
E004	DT, DTM, DTP, HD10	Black
E005	DT, DTM, DTP	Black, end cap
E007	DTM	Shrink boot adapter
E008	DT	Shrink boot adapter
E009	DRC	24 way and 40 way receptacle, B keys, housing is gray, flange is black
E016	EEC	Standard EEC box, molded-in transparent Ultem material
E019	AEC	Backshell adapter
<b>EE</b>		
EE01	DT	Shrink boot adapter, black
EE03	DTM	Shrink boot adapter, black
EE04	DTM	High temp, black
EE05	DT	High temp, enhanced seal retention (P012) on plug, end cap, black
<b>EF</b>		
EF01	DT	Fluorosilicone front seals, end cap
EF02	DT	Fluorosilicone front seals, latch guard end cap
<b>EK</b>		
EK02	DT	Plug, 18 cavity DT with 18 size 16 contacts, enhanced seal retention (P012), end cap, "A" key is gray, "B" key is black, "C" key is green, "D" key is brown

<b>Mod #</b>	<b>Series</b>	<b>Description</b>
<b>EP</b>		
<b>EP04</b>	DT	End cap (same as E003 mod)
<b>EP05</b>	DT	Latch guard end cap
<b>EP06</b>	DT	Plug with enhanced seal retention (P012), end cap
<b>EP07</b>	DT	Plug with enhanced seal retention (P012), black
<b>EP08</b>	DT	Plug with enhanced seal retention (P012), end cap, black
<b>EP09</b>	DT	Plug with enhanced seal retention (P012), latch guard end cap, black
<b>EP10</b>	DT, DTM	120 ohm terminating resistor (J1939), black
<b>EP11</b>	DT	Plug with enhanced seal retention (P012), shrink boot adapter, black
<b>EP12</b>	DT	Bussed receptacle, 4 and 6 way only, 1 buss, black, gold plated pins
<b>EP13</b>	DT	Bussed receptacle, 4 and 6 way only, 1 buss, black, nickel plated pins
<b>EP14</b>	DT	Bussed receptacle, 6 way, 2 busses, black, nickel plated pins
<b>EP20</b>	DT	Plug with enhanced seal retention (P012), shrink boot adapter
<b>F</b>		
<b>F001</b>	HDN	Inserts within connector made of Ultem
<b>G</b>		
<b>G001</b>	DRC	Gold plated pins
<b>G002</b>	DRC	Outside rows of pins are gold plated and rest are tin plated
<b>G003</b>	DT13/15	Gold plated pins
<b>G004</b>	DRC	Interface side pins are nickel plated, PCB side pins are tin plated
<b>G005</b>	DRCP	Tin plated signal pins, tin plated power pins
<b>GC</b>		
<b>GC03</b>	DRCP	Gold plated signal pins, depopulated power pins
<b>GC05</b>	DRCP	Tin plated signal pins, depopulated power pins
<b>GR</b>		
<b>GR01</b>	DTM13 (EEC headers)	Snap-in DTM PCB mounted header for DTM EEC enclosure, 12 and 24 pins, gold plated pins
<b>H</b>		
<b>H001</b>	HD30	Plated with yellow chromate conversion
<b>HL</b>		
<b>HL01</b>	HD30	Dust cap plated with yellow chromate conversion, sash chain with eyelet for #10 screw
<b>HL02</b>	HD30	Adapter for cable clamp (-072) plated with yellow chromate conversion
<b>J</b>		
<b>J001</b>	HD30	Reverse cavity marking identification on grommet

## Additional Resources

Mod #	Series	Description
<b>J059</b>	HD30	Reverse cavity marking identification on grommet, cable clamp (-059)
<b>K</b>		
<b>K001</b>	AEC	Molded-in shell marking, remove blue stripe, end cap
<b>K003</b>	DT16	Plug, 15 cavity DT with two size 12 contacts and 13 size 16 contacts, enhanced seal retention (P012), end cap, black
<b>K004</b>	DT16	Plug, 18 cavity DT with 18 size 16 contacts, enhanced seal retention (P012), end cap, black
<b>KP</b>		
<b>KP01</b>	DT16	Plug, six cavity DT with six size 16 contacts, enhanced seal retention (P012), end cap, green
<b>L</b>		
<b>L001</b>	HD30	Same as -059 (cable clamp)
<b>L003</b>	HD30	Cable clamp adapter (-072)
<b>L005</b>	HD30	Cable clamp adapter (-072) without drain holes
<b>L006</b>	HD30	-059 modification using adapter without drain holes
<b>L009</b>	DTHD	Sealed flange, inside mount
<b>L011</b>	DRC	Wire router
<b>L012</b>	DT, DTP, DTM	Welded flange
<b>L013</b>	DTHD	Sealed flange, outside mount
<b>L015</b>	HDP20	Threaded adapter for backshell strain relief
<b>L017</b>	HDP20	Ring adapter for backshell strain relief
<b>L018</b>	DRB	Wire router
<b>L020</b>	HD30, HD50	Removes #10 eyelet from the dust cap chain
<b>L024</b>	HDP20	Wide threaded adapter for backshell strain relief
<b>L072</b>	HD30	Adapter ring
<b>LE</b>		
<b>LE01</b>	DT	Sealed flange, inside mount, gasket, end cap
<b>LE03</b>	DT	Sealed flange, outside mount, o-ring sold separately, end cap, NOTE: DT04-08PA-LE03 comes with shrink boot adapter and o-ring on flange
<b>LE05</b>	DT	Sealed flange, inside mount, gasket, end cap
<b>LE06</b>	DT	Sealed flange, inside mount, reduced diameter seals (E seal), end cap
<b>LE07</b>	DT, DTP	Welded flange, end cap
<b>LE08</b>	DT	Welded flange, shrink boot adapter, gray
<b>LE09</b>	DT	Sealed flange, o-ring, end cap, black
<b>LE10</b>	DT	Sealed flange, inside mount, gasket, end cap, black
<b>LE11</b>	DT	Welded flange, end cap, black
<b>LE12</b>	DT	Welded flange, shrink boot adapter, black

Mod #	Series	Description
LE13	DT	Special adapter, round housing, end cap
LE14	DT	Welded flange, black
LE17	DT	Receptacle with extended shell and enhanced keys (B016), sealed flange, gasket sold separately, end cap, black
LE21	DT	Receptacle with extended shell and enhanced keys (B016), sealed flange, reduced diameter seals (E seal), end cap, one piece connector design, threaded stainless steel flange inserts

### N

N005	HD10	Receptacle with molded-in PCB pins, modified shell
N006	DT	Receptacle with 90° molded-in contacts
N012	DRC	Receptacle, one piece connector design

### P

P005	AEC	Special oversized seal on AEC Series plugs and dust caps
P006	DT, DTM	120 ohm terminating resistor (J1939)
P007	DT, DTM	Receptacle "Y" connector (J1939)
P012	DT	Plug with enhanced seal retention, 2-6 way are black, 8 and 12 way "A" key is gray, "B" key is black, "C" key is green, "D" key is brown
P013	DRC	Plug with bonded front seal, silicone adhesive
P016	DT	Bussed receptacle, 12 way, gold plated contacts
P017	DRC	Stainless steel retention clip for jackscrew
P018	DTP	Receptacle with 12 AWG wires attached
P019	DRC	Zinc chromate retention clip for jackscrew
P021	DT	Bussed receptacle, 6, 8, and 12 way, one buss, nickel plated pins
P026	DT	Bussed receptacle, 8 and 12 way, two busses, nickel plated pins
P027	DT	Bussed receptacle, 12 way, two busses, gold plated pins
P028	DT	Bussed receptacle, 8 way, two busses, nickel plated pins
P030	DT	Bussed receptacle, 12 way, four busses, nickel plated pins
P031	DT	Bussed receptacle, 12 way, four busses, gold plated pins
P032	DT	Integrated shrink boot adapter (J1939), black
P060	DT	Bussed receptacle, 2 way, one buss, nickel plated pins
P064	HD30, HDP20	24-91 arrangement without internal jumper
P075	DT	Bussed receptacle, 12 way, three busses, nickel plated pins
P080	HD10	J1939 Type II, green

### PE

PE01	DT	Latch guard, 120 ohm terminating resistor (J1939)
------	----	---

### PP

PP01	DT	Plug with enhanced seal retention (P012), 120 ohm terminating resistor (J1939), end cap, black
------	----	--

## Additional Resources

---

<b>Mod #</b>	<b>Series</b>	<b>Description</b>
<b>R</b>		
<b>R004</b>	DTM13	Custom enclosure header, 90° pins
<b>R005</b>	DTM13	Custom flange, 90° pins
<b>R008</b>	DTM13 (EEC headers)	Snap-in DTM PCB mounted header for DTM EEC enclosure, 12 and 24 pins
<b>R015</b>	DT13 (EEC headers)	Snap-in DT PCB mounted header for DT EEC enclosure, 12, 24, 36, and 48 pins

---

<b>RT</b>		
<b>RT01</b>	DT	Receptacle with MUR 460 diode
<b>RT02</b>	DT	Receptacle with Toshiba diode 3GZ41
<b>RT03</b>	DT	Receptacle with MUR 460 diode, 4 way available
<b>RT06</b>	DT	Receptacle with Phillips T.V.S diode 1.5KE130CA, green
<b>RT25</b>	DT	Receptacle with 27k ohm resistor, black

---

<b>#'s</b>		
<b>059</b>	HD30	Addition of threaded adapter and cable clamp assembly
<b>072</b>	HD30	Addition of threaded adapter
<b>1E</b>	HD30	Removes rivet and chain from protective dust cap

---

# Requirements & Standards

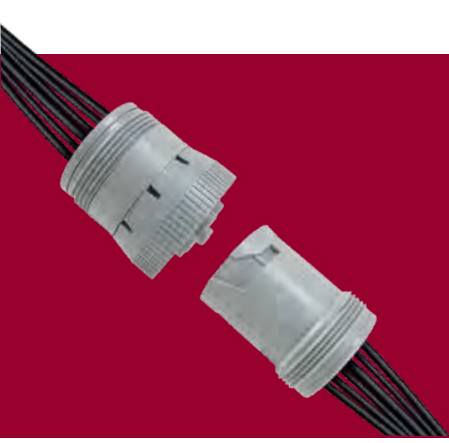

### IMDS

The International Material Data System (IMDS) is a collective, computer-based material data system developed as a collaborative effort by large automotive OEMs to manage environmentally relevant aspects of parts used in vehicles. It has been adopted as the global standard for reporting material content in the automotive industry. TE Connectivity recognizes IMDS and will work with customers that use the system.

### IP Rating

The IP Rating system is a way of classifying the degree of protection provided against the intrusion of solid objects, dust, and water in electrical enclosures. The 6 in IP 67 means that the connectors have to be completely sealed from fine dust. The 7 in IP 67 means that the connector needs to be protected from the effects of a one meter submersion. AMPSEAL and AMPSEAL 16 connectors are IP 67 rated. DEUTSCH connectors are rated for three feet submersion, which is just short of the IP Rating system's one meter requirement.

### IP 6K9K

IP 6K9K is similar to the standard IP Ratings, but is commonly referred to as a pressure washing specification. The letter K is used after the numbers to denote special testing. The 6K means the connectors need to be completely sealed from fine dust. The 9K means the connector needs to be protected from the penetrating effects of water used for high pressure/steam jet cleaning purposes. Several DEUTSCH connectors in the DT, DTM, DRC, and DRB Series have been through independent lab testing and pass IP 6K9K, as well as AMPSEAL connectors.

### J1939/11, J1939/13, and J1939/15

See CAN section.

### J2030

J2030 is an SAE standard for connectors between two cables or between a cable and an electrical component. The standard primarily focuses on the connectors used to mate to the electrical component. J2030 also provides environmental test and acceptance criteria for connectors used in DC electrical systems of 50 V or less in heavy duty applications typically used in off-highway equipment. Severe applications may require more rigid test levels, or field-testing on the intended application. AMPSEAL 16 connectors meet the SAE J2030 standard.

### RoHS

RoHS is a European directive on the Restriction of Hazardous Substances in electrical and electronic equipment. The directive restricts the use of lead, mercury, cadmium, hexavalent chromium, polybrominated biphenyls, and polybrominated diphenyl ether in new electrical and electronic components. All AMPSEAL, AMPSEAL 16, and DEUTSCH products are RoHS compliant, as well as LADD Distribution's boots, backshells, and gaskets.

### UL Recognized

A UL Recognized component is one that is expected to be installed within a larger assembly by a manufacturer, and this larger assembly is then expected to be tested by UL to become UL Listed. AMPSEAL, AMPSEAL 16, and many DEUTSCH connectors are UL Recognized. DEUTSCH connectors that are UL Recognized include the AEC, DRC, DT, DTM, DTP, HD10, and HDP20 Series. Not every variation and/or modification within a DEUTSCH series may be UL Recognized. AMPSEAL connectors are UL 94 V-0 rated and AMPSEAL 16 connectors are UL 94 HB rated. For additional information, visit [www.ul.com](http://www.ul.com).

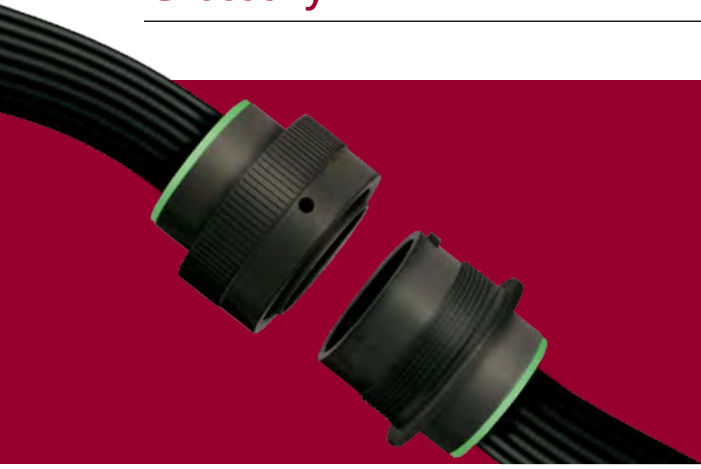

# Glossary

**AWG (American Wire Gauge):** Standardized system of wire diameter measurement. Commonly referred to as wire gauge. (Reference: National Bureau of Standards, Copper Wire Table [Handbook 100] AVS.)

**Adapter:** Device attached to a connector to allow connection to a second device that it would not otherwise be able to attach.

**Ambient Temperature:** The temperature of a medium (gas or liquid) surrounding an object.

**Ampere (amp):** The unit of current. One ampere is the current flowing through one ohm of resistance at one volt potential.

**ARC Resistance:** Time required for an electrical current to render the surface of a material conductive due to carbonization by the arc flame. Or, the time required for an arc to establish a conductive path in a material.

**Applicator:** Tooling used in automatic machines to crimp stamped & formed contacts.

**Backshell:** A secondary attachment for the rear of a connector to provide strain relief, environmental protection, and/or improved aesthetics.

**Barrel:** (1) Conductor Barrel: the section of the terminal, splice, or contact that accommodates the stripped wire. (2) Insulation Barrel: the section of the terminal, splice, or contact that accommodates the unstripped wire.

**Barrel Chamfer:** Beveled entry at mating end of the

socket contact. Reduces contact mating force for easier connector mating.

**Blocked Cavities:** Unused holes or contact positions in a connector which have been filled with sealing plugs or made inaccessible by modification to the rear grommet.

**Breakaway:** Connector with a slotted coupling ring. Coupling ring is intended to fragment and allow connectors to separate without damage to the implement in the event of an unintended pull-away.

**Boot:** Attachment for the back of a connector. Boots are typically flexible, made from plastic or plastisol, and may provide wire strain relief, environmental protection, and/or improved aesthetics.

**Bulkhead:** Dividing wall or partition. Bulkhead connectors are designed to be mounted to a dividing wall through a cutout.

**Buss (also bussbar, bus or busbar):** A thin conductive strip connecting multiple contacts within the body of a connector. Used to distribute electrical current to the branches of a circuit.

**Cable Clamp:** An attachment to provide support and strain relief to the wire bundle where it exits the connector.

**Cavity:** Hole in the connector grommet and housing, into which the contact must fit.

**Cold Heading:** Process by which contacts are formed from individual pieces of metal using dies and punches.



**Compression Nut:** Secondary backshell assembly. Threads onto rear of backshell to compact the wire bundle and provide additional support.

**Conductivity:** The capability of a material to carry an electrical current.

**Conductor:** Any material capable of carrying an electrical charge easily. The most common materials for wire and cable applications are aluminum and copper (bare or coated).

**Connector Position Assurance (CPA):** A locking mechanism on the connector that prevents the mated connectors from accidental unmating.

**Contact:** Conductive device crimped or soldered onto the end of conductor wire to allow the transfer of electricity or data to a second conductor. Contacts are most frequently used in multiples in connectors. Also commonly referred to as terminals, pins and/or sockets.

**Contact, Crimp:** Wire termination engineered to be permanently applied to conductor wire end with pressure. Does not use solder or heat.

**Contact, Insertable/Removable:** Wire termination that can be mechanically joined to or removed from the connector body.

**Contact, Pin:** Wire termination with solid mating end. Provides connection by insertion into a female or socket contact. Also referred to as male contact.

**Contact, Receptacle:** Wire termination with hollow mating end into which the pin or male terminal is inserted. Also referred to as a female contact.

**Contact, Socket:** Wire termination with hollow mating end into which the pin or male terminal is inserted. Also referred to as a female contact.

**Contact, Solder:** Wire termination joined to the wire conductor with a metal joining compound. Contacts intended for solder will typically have a cup, hollow-

cylinder eyelet or hook to accept a conductor and retain the applied solder.

**Contact Area:** The area where two conductors, a wire termination and a conductor, or two wire terminations touch, permitting the flow of electricity.

**Contact Arrangement:** The number, spacing, and organization of cavities in a connector.

**Contact Rating:** The maximum recommended amperage to be passed through a wire terminal.

**Contact Resistance:** The measurement of opposition to electrical flow through a pair of mated wire terminations. Resistance may be measured in ohms or in millivolt drop at a specified current over the mated terminals.

**Contact Retention:** The axial load in either direction that a terminal can withstand without being dislodged from its correct position in the connector.

**Contact Shoulder:** A small flange or collar on a terminal that limits the contact's travel into or removal from the connector.

**Contact Size:** Overall size of barrel determined by size of wire it will accept.

**Corrosion Resistance:** The ability of a substance to withstand corrosion.

**Coupling Ring:** Attached cylindrical ring used to lock mated connectors together.

**Crimping:** To mechanically secure a terminal or splice to a conductor by use of pressure.

**Crimping Die:** The part of a crimping tool that physically compresses the contact barrel and shapes the crimp.

**Crimp Tool:** Implement that permanently attaches a contact to a wire using pressure.

# Glossary

---

**Current (I):** The rate of transfer of electricity usually expressed in amperes.

**Current Rating:** The maximum continuous electrical flow of a current recommended for a given wire situation. Expressed in amperes.

**Dielectric Strength:** The voltage which an insulating material can withstand before breakdown occurs, usually expressed as a voltage gradient (such as volts/mil).

**Dielectric Test:** A test in which a voltage higher than the rated voltage is applied for a specific time to determine the adequacy of the insulation under normal conditions.

**Dielectric Withstanding Voltage:** The amount of leakage current that flows through the insulation.

**Diode:** Electronic component that allows electrical flow in one direction only.

**Direct Current:** An electrical current that flows in one direction only.

**Dust Cover:** Cap used to protect and conceal the interface of an unmated connector.

**“E” Seal:** Reduced diameter insert cavity in the rear grommet. Creates a proper seal with smaller than standard wire or insulation. Also referred to as extra thin or European seal. “E” seals are smaller than “N” and “T” seals.

**End Cap:** A protective cover integral to, or sonically welded onto the rear of a connector.

**Engaging and Separating Force:** Measured pull required to mate or unmate contacts or connectors.

**Enhanced Key:** Additional indexing or polarization to help prevent mis-mating.

**Enhanced Seal Retention:** Modification to the plug, front seal, and wedgelock to help prevent the seal from separating from the connector during unmating.

**Environmentally Sealed:** Maintains functionality when exposed to environmental elements.

**Extraction Tool:** An implement for removing contacts from a connector.

**Flange:** A flat, perpendicular extension of the connector body. Flanges are used for mounting and are typically found on receptacles.

**Flange Seal:** Elastomeric silicone seal used between flange and mounting surface to prevent leakage around the mounting cutout.

**Front Seal:** Elastomeric silicone seal or o-ring on the mating face of a connector. The front seal is also referred to as an interfacial seal and is usually found on the plug.

**Grommet:** Rubber or elastomeric seal. On connectors the grommet is on the rear or cable end of the connector and has the cavities through which the contact is inserted into the connector body.

**Ground:** A conducting connection between an electrical circuit and the earth or other large conducting body to serve as an earth thus making a complete electrical circuit.

**Header:** Flanged connector designed for wire to printed circuit board applications.

**Heat Seal:** In cabling, a method of sealing a tape wrap jacket by means of thermal fusion.

**Heat Shrink:** Type of tubing that shrinks to form a tight bond when heated.

**Indenter:** The part of a crimp tool or die that compresses the contact barrel onto the conductor.

**In-line:** Connectors that are not intended for use in mounted or PCB applications.

**Insertion Tool:** A device used to guide contacts into proper position within a connector.

**Inspection Hole:** An opening in a barrel contact to allow visual inspection of the conductor to verify that it has been inserted to the right depth.

**Insulation Resistance:** The measure of resistance offered by insulation material to the flow of current.

**Insulation:** A material having high resistance to the flow of electric current.

**Insulation Crimp:** (1) The physical deformation of the insulation sleeve covering a terminal or splice and the adjacent conductor insulation to hold the sleeve in place; (2) Shape combination of insulation sleeve to terminal or splice and conductor insulation after crimping.

**Insulation Resistance:** That property of an insulating material which resists electrical current flow through the insulating material when a potential difference is applied.

**Insulation Support:** The portion of the contact barrel enclosing but not crimped to the conductor insulation.

**Interface:** The surfaces of a mating pair of connectors that face each other when connected.

**Interfacial Seal:** A seal at the mating edge of the connector to prevent ingress of moisture or contaminants when a connector is properly mated.

**Internal Seal:** Waterproof form, typically made of silicone elastomer, that is inside the body of the connector. Provides moisture and fluid resistance when connectors are properly mated.

**Jacket:** An outer nonmetallic protective covering applied over an insulated wire or cable.

**Key:** Unique pattern of corresponding notches and projections on a set of mating connectors. The projections are intended to match the notches and prevent mis-mating.

**Keying Pin:** Solid plastic rod designed to be inserted into an empty socket cavity to help prevent mis-mating.

**Locator:** A device in a crimp tool to help provide proper contact position during crimping.

**Lockwasher:** Thin metal ring used between the panel nut and mounting surface to create spring force to ensure a tight fitting mount.

**Millimeters Squared or mm<sup>2</sup>:** Unit of measure for European Wire Size Standards (ref. DIN 72551-6 and ISO 6722-3).

**Moisture Resistance:** Amount of water (in any form) that a properly wired and mated connection will withstand without loss of electronic qualities or leakage.

**Mounting Bracket:** A rectangular metal device used to attach or mount connectors in an application.

**Mounting Clip:** A plastic or metal piece that attaches to a non-flanged connector to allow surface mounting.

**"N" Seal:** Normal wire seal diameter.

**Neoprene:** Thermosetting material, chemically known as polychloroprene, with excellent flame retarding and abrasion resisting qualities.

**Nest:** The part of a crimping die that supports the barrel during crimping.

# Glossary

---

**Newton (N):** A unit of force which is based on the metric system. It is the force that produces an acceleration of 1 meter per second per second when exerted on a mass of 1 kilogram.

**O-ring:** Circular seal found around the inside diameter of a receptacle: typically made from elastomeric or silicone material. Provides an environmental seal.

**Oxidation:** The process of uniting a compound with oxygen, usually resulting in an unwanted surface degradation of the material or compound.

**Panel Nut:** A hexagonal threaded plastic or metal ring. Along with a lockwasher, a panel nut is used for mounting.

**Partial Strip:** A quantity less than a standard full reel of stamped & formed contacts.

**PCB (Printed Circuit Board) Mount:** Connectors designed for wire to printed circuit board applications.

**Peak Voltage:** The maximum instantaneous voltage.

**Pin Housing (Cap):** One half of a mated pair of connectors. AMPSEAL 16 pin housings mate with a receptacle contact housing (plug) and house pin contacts.

**Plating:** Thin overlay coating of metal on contacts or components. Can be used to improve conductivity, provide for easy soldering, and prevent corrosion.

**Plug:** One half of a mated pair of connectors. Plugs typically have the locking mechanism for the mated pair, usually house the sockets, and mate with a receptacle.

**Pre-Tinned:** Solder applied to the contact and/or conductor prior to soldering.

**Primary Latch Reinforcement (PLR):** Locking mechanism that snaps into place on the mating face of a connector after the connector is populated. A PLR holds contacts in correct alignment for mating and prevents them from being removed.

**Pull-Out Force:** Measured energy required to separate a conductor from a contact, or a contact from a termination assembly.

**Ratchet Control:** A crimping device that helps provide a full crimping cycle by allowing motion in only one direction until contact is fully crimped.

**Receptacle:** One half of a mated pair of connectors. Receptacles mate with a plug and usually house pins.

**Receptacle Housing (Plug):** One half of a mated pair of connectors. AMPSEAL and AMPSEAL 16 plugs typically have the locking mechanism for the mated pair, house the receptacle contacts, and mate with a pin housing (cap) or header.

**Reduced Diameter Seal:** Smaller than standard holes in the connector grommet.

**Removal Tool:** Device to disengage contacts from connector body.

**Retaining Bolt:** Screw used to draw and hold mating connectors together.

**Retaining Sleeve:** Lining sheath that fits into receptacle body to maintain internal seal and provide keying.

**Reverse Arrangement:** Non-standard cavity/contact assignment (eg. Plug connectors that require pin contacts, and receptacles that require socket contacts).

**Ring Adapter (HDP20):** Cylindrical rim or collar attached to the rear of a connector to allow the attachment of backshells or strain relief.

**Sealed Flange:** A flange that is molded or tooled as an integral part of the connector body to help prevent leakage at the mounting site.

**Sealing Plug:** A non-conductive dummy pin inserted to fill an open cavity in a connector. Sealing plugs are required to maintain the integrity of the environmental seal.

**Seamless Terminal or Splice:** Terminal or splice conductor barrel made from a single piece of metal, finished without lines or grooves that would typically appear where metal is joined to metal.

**Secondary Lock:** Device inserted into or onto the connector interface to position and hold contacts in correct alignment. Secondary locks are called wedgelocks or terminal position assurance.

**Self-Extinguishing:** The characteristic of a material whose flame is extinguished after the igniting flame is removed.

**Selective Plating:** Application of a thin coating of a finish metal to specific parts of a contact, but not to others. If selective plating is used, plating is typically applied to the mating surface to provide better conductivity and reduce wear and corrosion.

**Shells:** Outside case into which the insert and contacts are assembled. Shells of mating connectors usually also provide proper alignment and protection of projecting contacts. Also known as housing or body.

**Shield:** A metallic layer, commonly aluminum or copper, of tape, braid or spiral wrapped wire construction. Its primary purpose is to prevent electrostatic or electromagnetic interference between adjacent wires and external sources.

**Shielded Cable:** A cable in which the insulated conductor or conductors is/are enclosed in a conducting envelope or envelopes. Constructed so that essentially every point on the surface of the insulation is at ground potential or at some predetermined potential with respect to ground.

**Shrink Boot Adapter:** Thermoplastic rear adapter designed to provide a lip for heat shrink to form around to attach it securely to a connector.

**Signal:** An electric current used to convey information either digital, analog, audio or video.

**Sleeving:** A braided, knitted or woven tube.

**Splice:** A connection of two or more conductors or cables to provide good mechanical strength as well as good conductivity.

**Socket Contact Sleeve:** A cylindrical, protective encasement for the contact fingers or a contact spring. The socket contact sleeve holds the inner mechanism of the contact in place and provides a smooth exterior surface.

**Solderless Connection:** Joint between two metals created by pressure without the use of metallic alloy compounds or heat.

**Solid Contact:** Closed barrel terminal manufactured using a cold heading process.

**Stamped & Formed Contact:** Open barrel terminal manufactured using a precision stamping process.

**Strain Relief:** Hard plastic or metal device that attaches to the rear of a connector to provide wire support.

**Strand:** A single filament of uninsulated wire.

**Strip:** To remove insulation from a conductor.

**Swedge:** A cold-forging process to press-fit or force two metal forms into one.

**"T" Seal:** Reduced diameter insert cavity in the rear grommet. Also referred to as thin seal, a "T" seal allows for the use of smaller wire or thinner insulation diameter. A "T" seal is larger than an "E" seal and smaller than an "N" seal.

**Temperature Coefficient of Resistivity:** The change in resistance per degree of change in temperature.

**Terminal:** A device designed to attach to the end of a conductor wire to allow it to connect to another conductor wire and allow electrical current to pass between them. Also commonly referred to as a contact.

# Glossary

---

**Terminating Resistor:** A connector that includes a device to create electrical resistance. Commonly used on J1939 applications to end the main trunk line or bus network.

**Thermal Cycling:** Temperature modulation process developed to improve the performance, strength, and longevity of a variety of materials.

**Threaded Adapter:** A cylindrical device with screw threads attached to rear of connector to allow the attachment of a threaded backshell or strain relief.

**Threaded Rear:** Screw threads at the non-mating end of a connector to allow the attachment of a threaded backshell or strain relief.

**Terminal Position Assurance (TPA):** A secondary locking mechanism. Snapped into place on the mating face of a connector after the connector is populated, a TPA holds contacts in correct alignment for mating and prevents them from being removed.

**Vibration:** A periodic motion of the particles of sound or other waves.

**Volt:** A volt is the unit of electromotive force or electric pressure, a kin to water pressure in pounds per square inch.

**Voltage:** The term most often used to designate electric pressure that exists between two points and is capable of producing a flow of current when a closed circuit is connected between the two points.

**Wedglock:** A device inserted into or onto the mating face of a connector to position and hold contacts in correct alignment.

**Wicking:** The longitudinal flow of a liquid in a wire or cable construction.

**Wiping Action:** Movement of two electrical contacts sliding against each other.

**Wire Range:** The limits of conductor size accommodated by a contact barrel. Also applies to the insulated conductor diameter accommodated by a sealing grommet.

**Wire Router:** Protective device attached to the rear of connector to provide wire bundle strain relief.

## Index

**A****Adapters**

- 072 adapter 74
- L015 conduit adapter 76
- L015 threaded adapter 74
- L017 ring adapter 74
- L024 wide threaded adapter 74
- Shrink boot adapter 49

**AEC Series 13–15****AMPSEAL Connectors 17–21****AMPSEAL 16 Connectors 23–27****B****Backshells**

- AMPSEAL 20
- AMPSEAL 16 26
- DRC Series 41
- DT Series 52
- HD10 Series 64
- HD30/HDP20 Series 76–77
- STRIKE Series 83

**Boots**

- AEC Series 15
- DRB Series 33
- DRC Series 41
- DT/DTM/DTP Series 51
- HD30/HDP20 Series 75

**Breakaway connector**

- HD30 Series 73, 95

**Bussing Options 85–89****C****Cable clamps**

- HD30 Series 74

**CAN (Controller Area Network) 91–95****Compression nuts**

- HD10 Series 64
- HD30/HDP20 Series 76

**Contacts 115–128****Contact specifications 117–118****Contact styles**

- Solid 116, 120
- Stamped & formed 116, 120–121

**Coupling rings**

- HD10 Series 63

**Crimp**

- General 124
- Inspection 125
- Tools 131–135

**Crimp sleeve reducer 126****Crimp tools. *See also* Tooling**

- Automated 131–133
- Hand 134–135

**D****D hole punch 79****Dimensions**

- AEC Series 14
- AMPSEAL 18
- AMPSEAL 16 24
- Bussed feedback receptacles 86
- DRB Series 30
- DRC Series 39
- DT/DTM/DTP Series 45
- DTHD Series 112
- DTMH Series 57
- DTMN Series 59
- DTV Series 56
- EEC enclosures 109–110
- HD10 Series 62
- HD30/HDP20 Series 70
- HDFB Series 89
- Jiffy Splices 114
- STRIKE Series 82

**Diodes 97–99****DRB Series 29–36****DRC Series 37–42****DT/DTM/DTP Series 43–54****DTHD Series 112–113**

**DTMH Series 57**

**DTMN Series 59**

**DTT Style Hand Tools 135**

**DTV Series 56**

**Dust caps**

AEC Series 15

DT/DTM Series 50

HD10 Series 65

HD30/HDP20 Series 75

## E

**EEC enclosures 108–110**

**End caps**

DTHD Series 113

DT Series 49

**“E” seal**

DT Series 49

HD30/HDP20 Series 72–73

## F

**Flange modifications**

DTHD Series 113

DT Series 49

**Flanges**

DRB Series 32

## G

**Gaskets**

DRC Series 42

DT/DTM/DTP Series 50

HD10 Series 66

HD30/HDP20 Series 77

**Grommet sealing ranges 119**

## H

**HD10 Series 61–67**

**HD30/HDP20 Series 69–80**

**HDFB Series 88–89**

## I

**Instructions (How To)**

AMPSEAL 20–21

AMPSEAL 16 27

Crimp sleeve reducer 128

DRB Series 34–35

DT Family , 27

DTT style hand tools 138–139

HD30/HDP20 Series 79–80

HDT-48-00 hand tool 137

Jiffy Splice 20, 114

Sealing plugs 128

STRIKE Series 84

Wire stripping 137

**ISO box 95**

## J

**J1939**

J1939/11 94

J1939/12 95

J1939/13 93

J1939/15 95

**Jiffy Splices 114**

## K

**Keying pins 126**

## L

**Lanyards**

HD10 Series 67

**Lockwashers**

HD30/HDP20 Series 77

## M

**Material specifications 7**

**Modifications**

Descriptions 142–148

059 74

072 74

A004 103

AG02 103

B010 63

B016 48, 105

B026 107

BL04 49

BL08 49

BL10 49

BP03 64

C015 49

C023 104

C030 74

CL03 49

CL07 49

CL09 49

E003 19, 24, 49, 113

E004 49, 63

E005 49

E007 49

E008 49

E016 110

EE04 58

Flange 49

G002 104

G003 105, 106

GR01 109



- GR02 108
- L006 74
- L009 113
- L012 49
- L013 113
- L015 74
- L017 74
- L018 30
- L024 74
- LE01 49
- LE05-LE12 49
- LE14 49
- LE17 49
- LE21 49
- N005 64, 107
- N012 104, 105
- P012 48
- P064 73
- P080 64
- R008 109
- R015 108
- Mounting brackets 89**
- Mounting clips**
  - AMPSEAL 16 26
  - DT/DTM/DTP Series 54
  - DTHD Series 113
- N**
- “N” seal**
  - HD30/HDP20 Series 72–73
- P**
- Panel nut**
  - HD30/HDP20 Series 78
- PCB pins 123**
- PCB (Printed Circuit Board) 101–110**
- Performance specifications**
  - Connectors 5–6
  - Contacts 117–118
- Primary latch reinforcement (PLR) 25, 27**
- R**
- Removal tools 135–136**
- Resistors 97–99**
- S**
- Sealing plugs 127**
- Shrink boot adapter**
  - DT/DTM Series 49
- Specifications**
  - Material 7
  - Performance
    - Connectors 5, 6
    - Contacts 117–118
- Standards 149**
- Strain relief**
  - AMPSEAL 20
  - AMPSEAL 16 26
  - DT Series 52–53
  - HD10 Series 65
  - HD30/HDP20 Series 76–77
- STRIKE Series 81–84**
- T**
- Tooling**
  - Crimp tools
    - Automated 131–132
    - Hand 134–135
  - D hole punch 79
  - Insert/removal tools 135–136
- Tooling accessories 131–133**
- TPA (Terminal Position Assurance) 7, 57**
- “T” seal**
  - HD30/HDP20 Series 72–73
- W**
- Wedgelocks**
  - DRB Series 32, 33
  - DT/DTM/DTP Series 47–48
  - DTV Series 56
- Wire router**
  - DRB Series 30
  - DRC Series 41
- Wire sealing ranges 119–120**

While LADD Distribution has made every reasonable effort to ensure the accuracy of the information in this catalog, LADD does not guarantee that it is error-free, nor does LADD make any other representation, warranty or guarantee that the information is accurate, correct, reliable or current.

LADD reserves the right to make any adjustments to the information contained herein at any time without notice. LADD expressly disclaims all implied warranties regarding the information contained herein, including, but not limited to, any implied warranties of merchantability or fitness for a particular purpose.

The dimensions in this catalog are for reference purposes only and are subject to change without notice. Specifications are subject to change without notice. Consult LADD for the latest dimensions and design specifications.

LADD, TE Connectivity, TE and TE connectivity (logo), AMPSEAL, AMPSEAL 16, DEUTSCH, STRIKE are trademarks.  
© 2014 LADD Distribution LLC, a TE Connectivity company





Компания «Океан Электроники» предлагает заключение долгосрочных отношений при поставках импортных электронных компонентов на взаимовыгодных условиях!

Наши преимущества:

- Поставка оригинальных импортных электронных компонентов напрямую с производств Америки, Европы и Азии, а так же с крупнейших складов мира;
- Широкая линейка поставок активных и пассивных импортных электронных компонентов (более 30 млн. наименований);
- Поставка сложных, дефицитных, либо снятых с производства позиций;
- Оперативные сроки поставки под заказ (от 5 рабочих дней);
- Экспресс доставка в любую точку России;
- Помощь Конструкторского Отдела и консультации квалифицированных инженеров;
- Техническая поддержка проекта, помощь в подборе аналогов, поставка прототипов;
- Поставка электронных компонентов под контролем ВП;
- Система менеджмента качества сертифицирована по Международному стандарту ISO 9001;
- При необходимости вся продукция военного и аэрокосмического назначения проходит испытания и сертификацию в лаборатории (по согласованию с заказчиком);
- Поставка специализированных компонентов военного и аэрокосмического уровня качества (Xilinx, Altera, Analog Devices, Intersil, Interpoint, Microsemi, Actel, Aeroflex, Peregrine, VPT, Syfer, Eurofarad, Texas Instruments, MS Kennedy, Miteq, Cobham, E2V, MA-COM, Hittite, Mini-Circuits, General Dynamics и др.);

Компания «Океан Электроники» является официальным дистрибьютором и эксклюзивным представителем в России одного из крупнейших производителей разъемов военного и аэрокосмического назначения «JONHON», а так же официальным дистрибьютором и эксклюзивным представителем в России производителя высокотехнологичных и надежных решений для передачи СВЧ сигналов «FORSTAR».



## JONHON

«JONHON» (основан в 1970 г.)

Разъемы специального, военного и аэрокосмического назначения:

(Применяются в военной, авиационной, аэрокосмической, морской, железнодорожной, горно- и нефтедобывающей отраслях промышленности)

«FORSTAR» (основан в 1998 г.)

ВЧ соединители, коаксиальные кабели, кабельные сборки и микроволновые компоненты:

(Применяются в телекоммуникациях гражданского и специального назначения, в средствах связи, РЛС, а так же военной, авиационной и аэрокосмической отраслях промышленности).



Телефон: 8 (812) 309-75-97 (многоканальный)

Факс: 8 (812) 320-03-32

Электронная почта: [ocean@oceanchips.ru](mailto:ocean@oceanchips.ru)

Web: <http://oceanchips.ru/>

Адрес: 198099, г. Санкт-Петербург, ул. Калинина, д. 2, корп. 4, лит. А