

Dimensions: [mm]



Dimensions:

Properties		Value	Unit	Tol.
Diameter	Ø D	8	mm	±1.5
Length	L	20	mm	±1.5
Pitch	P	3.5	mm	±0.5
Pin Diameter	Ø F	0.6	mm	±0.02
Pitch	p	3.5	mm	±0.5
Hole Diameter	Ø f	0.9	mm	±0.02

Recommended Hole Pattern: [mm]



Schematic:



Electrical Properties:

Properties		Test conditions	Value	Unit	Tol.
Capacitance	C	10 mA/ F	3	F	+30%/-10%
Rated Voltage	U_R	@ 65 °C	2.7	V (DC)	max.
Rated Voltage	U_R	@ 85 °C	2.3	V (DC)	max.
Surge Voltage	U_S	@ 65 °C	2.85	V (DC)	max.
ESR	$R_{ESR DC}$	10 ms	70	mΩ	max.
ESR	$R_{ESR AC}$	5 mV @ 1 kHz	60	mΩ	max.
Rated Discharge Current	I_{Rated}		0.7	A	typ.
Max. Discharge Current	I_{Max}		3.3	A	typ.
Leakage Current	I_{Leak}	72 hrs. @ U_R	0.008	mA	typ.
Power Density	P		18.08	kW/ kg	typ.
Energy Density	E		2.1	Wh/ kg	typ.

General Information:

Storage Conditions (in original packaging)	15 °C - 35 °C; 10 % up to 75 % RH		
Operating Temperature	-40 up to +65 °C		
Life Cycle	500000	Cycles	
Weight	m	1.4	g
Test conditions of Electrical Properties: +20 °C, 35 % RH if not specified differently			
Component conform to REACH and RoHS requirements and standards			



Würth Elektronik eiSos GmbH & Co. KG
 EMC & Inductive Solutions
 Max-Eyth-Str. 1
 74638 Waldenburg
 Germany
 Tel. +49 (0) 79 42 945 - 0
 www.we-online.com
 eiSos@we-online.com

CHECKED ReKa	REVISION 001.001	DATE (YYYY-MM-DD) 2019-01-29	GENERAL TOLERANCE DIN ISO 2768-1m	PROJECTION METHOD
DESCRIPTION WCAP-STSC Supercapacitors (EDLC's)			TECHNICAL REFERENCE STP0820305Q2R7DSPB15000	
SIZE/TYPE 8.0 x 20.0			ORDER CODE 850617030001	
BUSINESS UNIT eiCap		STATUS Valid	PAGE 1/9	

Component Marking:

1 st Line	Supercapacitor
2 nd Line	EDLC Energy Capacity: 0.003 Wh
3 rd Line	Rated Voltage: 2.7 V (DC) , Capacitance Value: 3 F , max. Temp. 65 °C
4 th Line	Marking neg. Pol
5 th Line	WCAP-STSC
6 th Line	RU and Datecode YWW

Life Time Performance:

Test Condition	Shelf Life	Cycle Life	Endurance
Life Time	up to 2 years	after 500000 cycles	1000 h, @65°C
Voltage	None	U _R applied	U _R applied
Current	None	I _R	I _R
Δ C	≤ 10% of initial value	≤ 30 % of initial measured value	≤ 30 % of initial measured value
Δ ESR	≤ 50% of specified value	≤ 2 x ESR	≤ 2 x ESR
Comments	25°C ± 10°C / 60% ±15% RH (dry and cool condition); discharged ≤ 0.2 V		

Additional Information:

Properties	Description	Formular
Max. Discharge Current I _{max} – [A]	is the current taking 1 sec. to discharge from U _R to U _{R/2}	$I_{max} = \frac{U_R/2}{1 \text{ sec}/C + R_s}$
Rated Discharge Current I _{Rated} – [A]	is the current taking 5 sec. to discharge from U _R to U _{R/2}	$I_{Rated} = \frac{U_R/2}{5 \text{ sec}/C + R_s}$
Leakage Current I _{Leak} – [mA]	is measured at 25°C (after holding 72 h at U _R)	
Power Density P – [kW/kg]	impedance matched with m (kg) as net weight for Capacitor	$P_{max} = \frac{U_R^2}{4 * R_s * m}$
Energy Density E – [Wh/kg]	with m(kg) as net weight for Capacitor	$E = \frac{C * U_R^2}{2 * 3600 * m}$
ESR R _{ESR} – [mΩ]	R_{ESR AC} : measured by contact resistance meter, conditions: Amplitude: 5 mV Frequency 1 kHz R_{ESR DC} : measured by constant current discharge method (i.a.w. IEC62391) I _{CC} : constant discharge current	$R_{DC} = \frac{\Delta U}{I_{CC}}$
Capacitance C – [F]	I _{CC} [A]: constant discharge current U ₁ [V]: U _R x 0.8 U ₂ [V]: U _R x 0.4 t ₁ [sec]: time at U ₁ t ₂ [sec]: time at U ₂	$C = \frac{dQ}{dU} = I_{CC} * \frac{t_2 - t_1}{U_1 - U_2}$

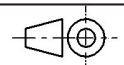

	Würth Elektronik eiSos GmbH & Co. KG EMC & Inductive Solutions Max-Eyth-Str. 1 74638 Waldenburg Germany Tel. +49 (0) 79 42 945 - 0 www.we-online.com eiSos@we-online.com	CHECKED ReKa	REVISION 001.001	DATE (YYYY-MM-DD) 2019-01-29	GENERAL TOLERANCE DIN ISO 2768-1m	PROJECTION METHOD 	
		DESCRIPTION WCAP-STSC Supercapacitors (EDLC's)				TECHNICAL REFERENCE STP0820305Q2R7DSPB15000	
		ORDER CODE 850617030001				BUSINESS UNIT eiCap	STATUS Valid

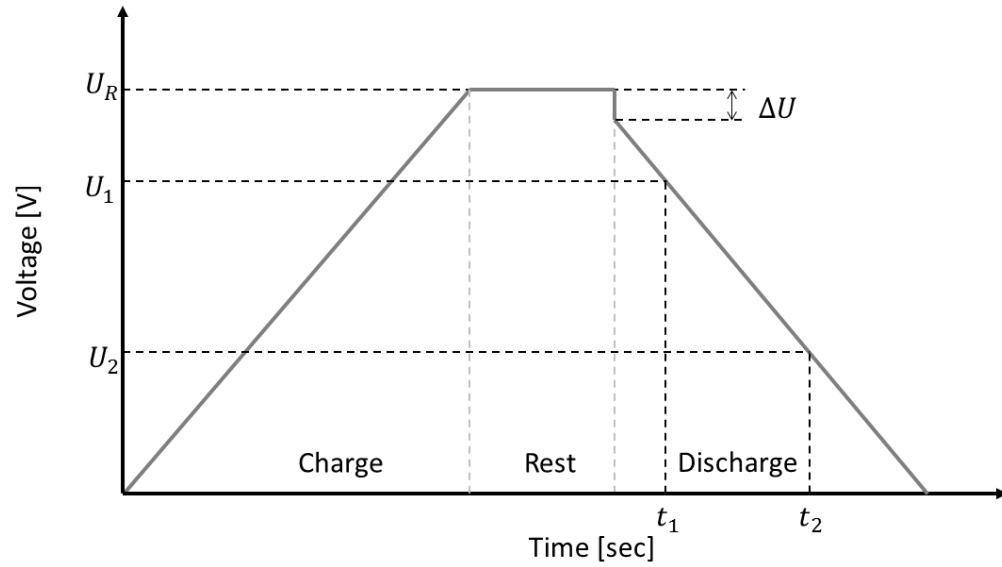
Charge & Discharge Characteristic:

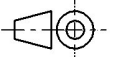

$$U_1(t_1) = 0.8 \times U_R$$

$$U_2(t_2) = 0.4 \times U_R$$

		CHECKED ReKa	REVISION 001.001	DATE (YYYY-MM-DD) 2019-01-29	GENERAL TOLERANCE DIN ISO 2768-1m	PROJECTION METHOD 
 <p>Würth Elektronik eiSos GmbH & Co. KG EMC & Inductive Solutions Max-Eyth-Str. 1 74638 Waldenburg Germany Tel. +49 (0) 79 42 945 - 0 www.we-online.com eiSos@we-online.com</p>		DESCRIPTION WCAP-STSC Supercapacitors (EDLC's)			TECHNICAL REFERENCE STP0820305Q2R7DSPB15000	
		SIZE/TYPE 8.0 x 20.0			ORDER CODE 850617030001	
		BUSINESS UNIT eiCap	STATUS Valid		PAGE 3/9	

Packaging Specification - Bag and Carton: [mm]

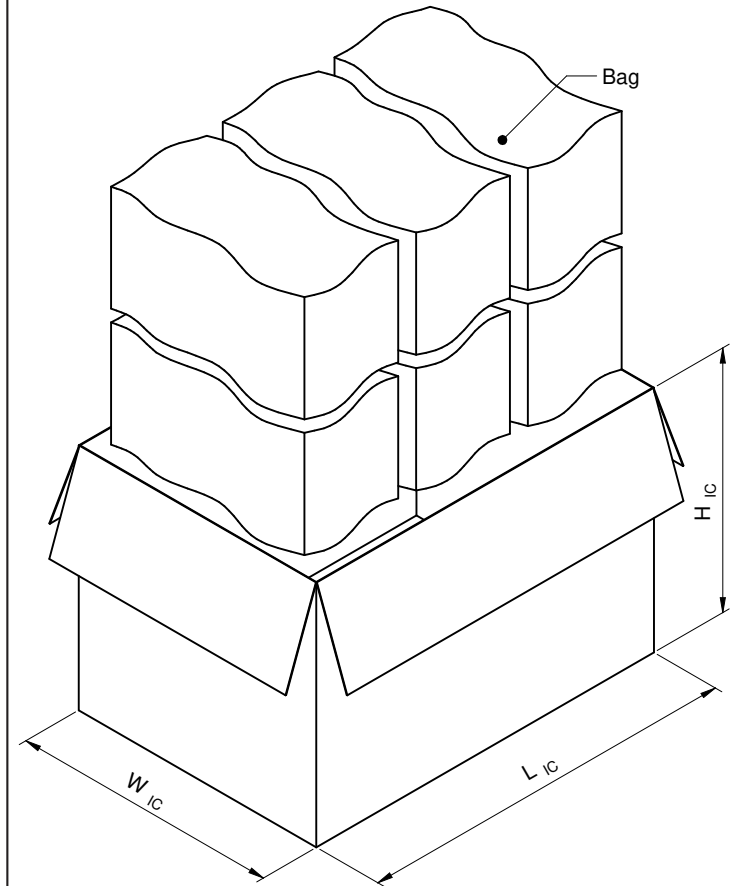
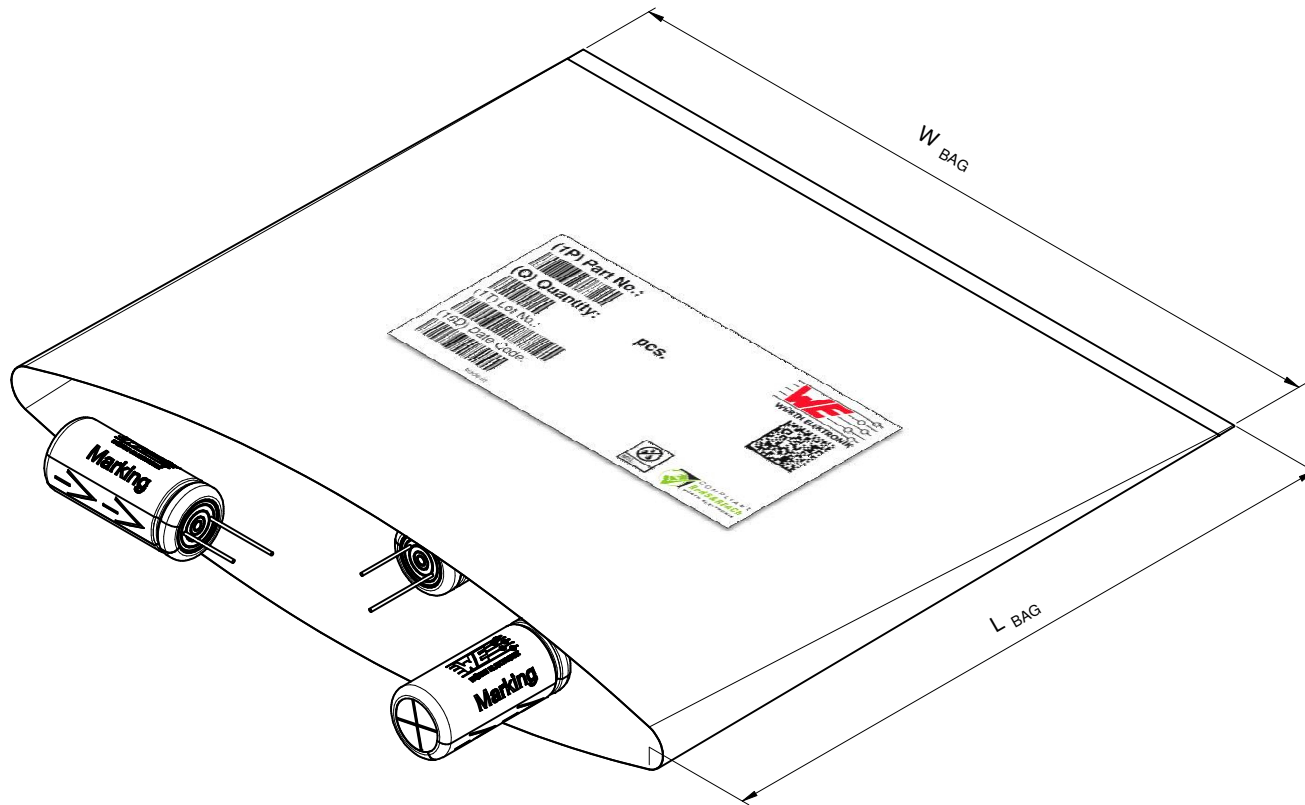

L _{BAG} (mm)	W _{BAG} (mm)	Packaging Unit	Material
typ.	typ.	pcs.	
250,00	300,00	500	PE

L _{IC} (mm)	W _{IC} (mm)	H _{IC} (mm)	Packaging Unit	Material
typ.	typ.	typ.	pcs.	
287,00	202,00	195,00	3000	Paper

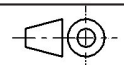
		CHECKED ReKa		REVISION 001.001	DATE (YYYY-MM-DD) 2019-01-29	GENERAL TOLERANCE DIN ISO 2768-1m	PROJECTION METHOD 
		DESCRIPTION WCAP-STSC Supercapacitors (EDLC's)				TECHNICAL REFERENCE STP0820305Q2R7DSPB15000	
Würth Elektronik eiSos GmbH & Co. KG EMC & Inductive Solutions Max-Eyth-Str. 1 74638 Waldenburg Germany Tel. +49 (0) 79 42 945 - 0 www.we-online.com eiSos@we-online.com		ORDER CODE 850617030001		BUSINESS UNIT eiCap	STATUS Valid	PAGE 4/9	
		SIZE/TYPE 8.0 x 20.0					

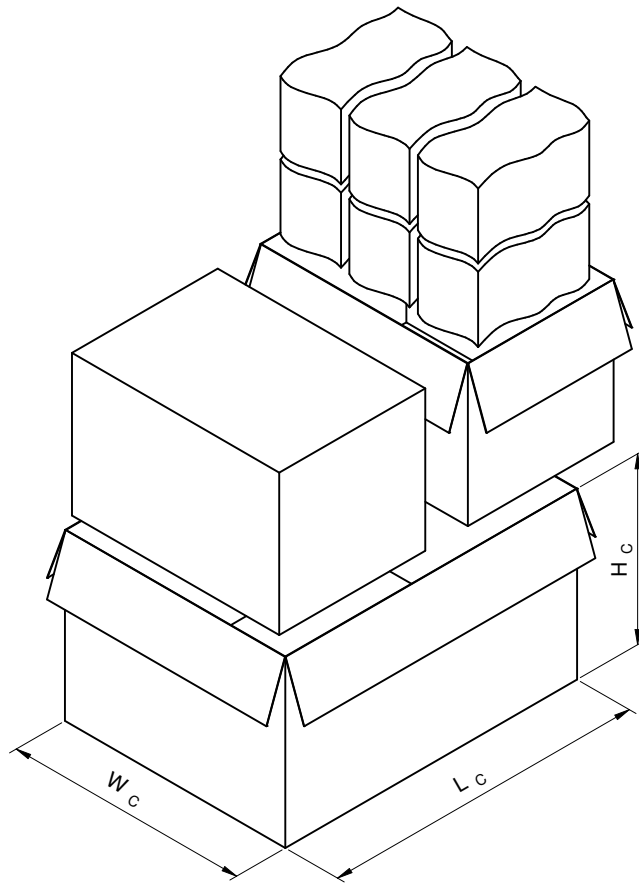

L _c (mm)	W _c (mm)	H _c (mm)	No. of inner Carton	Packaging Unit	Material
typ.	typ.	typ.	pcs.	pcs.	
404,00	305,00	229,00	2	6000	Paper

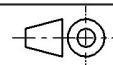
		CHECKED ReKa		REVISION 001.001	DATE (YYYY-MM-DD) 2019-01-29	GENERAL TOLERANCE DIN ISO 2768-1m	PROJECTION METHOD 
		DESCRIPTION WCAP-STSC Supercapacitors (EDLC's)					TECHNICAL REFERENCE STP0820305Q2R7DSPB15000
Würth Elektronik eiSos GmbH & Co. KG EMC & Inductive Solutions Max-Eyth-Str. 1 74638 Waldenburg Germany Tel. +49 (0) 79 42 945 - 0 www.we-online.com eiSos@we-online.com		ORDER CODE 850617030001		SIZE/TYPE 8.0 x 20.0	BUSINESS UNIT eiCap	STATUS Valid	PAGE 5/9

The following conditions apply to all goods within the product series of Super Capacitors of Würth Elektronik eiSos GmbH & Co. KG:

General:

- This electronic component was designed and manufactured for use in general electronic equipment.
- Würth Elektronik must be asked for a written approval (following the certain PPAP level procedure) before incorporating the components into any equipment in the field such as military, aerospace, aviation, nuclear control, submarine, transportation (automotive control, train control, ship control), transportation signal, disaster prevention, medical, public information network etc. where higher safety and reliability are especially required and/or if there is the possibility of direct damage or human injury.
- Electronic components that will be used in safety-critical or high-reliability applications, should be pre-evaluated by the customer.
- Direct mechanical impact to the product shall be prevented as material of the body, pins or termination could flake or in the worst case it could break.
- Avoid any water or heavy dust on capacitors surface, which may cause electrical leakage, damage, overheating or corrosion.
- Würth Elektronik products are qualified according to international standards, which are listed in each product reliability report. Würth Elektronik does not guarantee any customer qualified product characteristic, beyond Würth Elektronik specifications, for its validity and sustainability over time.
- The customer is responsible for the functionality of their own products. All technical specifications for standard products also apply to customer specific products.
- The component was designed and manufactured to be used within the datasheet specified values. If the usage and operation conditions specified in the datasheet are not met, the body, pins or termination may be damaged or dissolved.
- Do not apply any kind of flexural or compressive force onto soldered or unsoldered component.
- The capacitance tolerance as specified within the datasheet is only valid on the date of delivery and according specified measurement criteria.

Product specific:

Polarity:

The product has a polarity. In operation this polarity needs to be considered and adhered. Reverse voltage can damage or destroy the product. The polarity is marked with a stripe and the word NEG as well as a negative sign on the lateral surface of the capacitor.

Overvoltage:

Avoid any overvoltage and do not apply a continuous overvoltage. If an overvoltage is applied to the capacitor, the leakage current can increase drastically. The applied working voltage is not allowed to exceed the rated working voltage of the specific capacitor.

Operating Temperature:

The capacitor shall not be operated above the operating temperature, which is stated within this datasheet of the specific capacitor. The achievable lifetime of the capacitor is correlating to the applied temperature. In order to achieve the maximum lifetime, the capacitor should be operated by the lowest possible temperature conditions within the application. During charging and discharging in a short cycles, self-heating is generated by internal resistance. The operating temperature should not exceed the above stated operating temperature, including any self-heating.

Charge and Discharge:

Frequent and quick charge / discharge cycles may generate heat inside the capacitor. Do not exceed the above stated discharge current. Exceeding the maximal current, stated above, can cause a decrease of capacitance, an increase of leakage current or breakdown. For assistance with your application please consult our technical support.

Storage Conditions:

The storage conditions for a capacitor are recommended to be as given above. Do not expose the capacitor to environments with hazardous gas, ozone, ultraviolet rays or any kind of radiation. Avoid any contact of the capacitor with direct sunshine, saltwater, spray of water or types of oil during storage. All products shall be used before the end of the period of 24 months based on the product date code, if not a 100 % solderability cannot be guaranteed. The capacitance tolerance as specified within the datasheet is only valid on the date of delivery.

Soldering:

The solder profile must comply with the Würth Elektronik technical soldering specification. All other profiles will void the warranty. All other soldering methods are at the customers' own risk. Strong forces which may affect the coplanarity of the components' electrical connection with the PCB (i.e. pins), can damage the part, resulting in void of the warranty. Do not use excessive nor insufficient flux. Provide enough washing when water-soluble flux is used. During wave soldering only the pins / terminals should have contact with hot solder bath / wave. Assure that no direct contact of capacitor body with hot solder bath / wave or any other component will happen. Soldering must be done from the opposite PCB side where capacitor body is placed.

Dangerous Goods and Handling:

Due to the European agreement concerning the international carriage of dangerous good by road (ADR) capacitors with an energy storage capacity of 0.3 Wh or more are considered as dangerous goods. Refer to special provision 361 for detailed information. Each capacitor should be protected against unintended short circuit or be fitted with a metal strap connecting the terminals, if transported. Capacitors installed in equipment shall be either in an uncharged state or protected against short circuit. A fully charged capacitor shall not be short circuited without a protective resistor of at least 1 kΩ.

Cleaning:

Do not wash the assembled capacitors with the following cleaning agents:

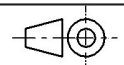
 <p>Würth Elektronik eiSos GmbH & Co. KG EMC & Inductive Solutions Max-Eyth-Str. 1 74638 Waldenburg Germany Tel. +49 (0) 79 42 945 - 0 www.we-online.com eiSos@we-online.com</p>	CHECKED	REVISION	DATE (YYYY-MM-DD)	GENERAL TOLERANCE	PROJECTION METHOD	
	ReKa	001.001	2019-01-29	DIN ISO 2768-1m		
	DESCRIPTION				TECHNICAL REFERENCE	
	WCAP-STSC Supercapacitors (EDLC's)				STP0820305Q2R7DSPB15000	
ORDER CODE						
850617030001						
SIZE/TYPE	BUSINESS UNIT	STATUS	PAGE			
8.0 x 20.0	eiCap	Valid	6/9			

- Petroleum system solvents: may cause degeneration of the rubber seal material
- Alkali system solvents: may cause corrosion and dissolve of the casing
- Halogenated solvents: may cause corrosion and failure of the capacitor
- Acetone: component marking may be erased
- Aromatic solvents like xylene: may cause deterioration of the rubber seal material
- Verify the following points when washing is applied to capacitors:
- Please monitor conductivity, ph-value, specific gravity and the water content of cleaning agents. Contamination adversely affects these characteristics.
- Be sure to not expose the capacitors under solvent rich conditions or keep capacitors inside a closed container. In addition, please dry the solvents on the PCB and the capacitor sufficiently with an air knife (temperature should be less than the maximum rated category temperature of the capacitor) for 10 minutes.
- Capacitors can be characteristically and catastrophically damaged by halogen ions, particularly by chlorine ions. The degree of the damage mainly depends upon the characteristics of the electrolyte and rubber seal material. When halogen ions come into contact with the inside of the capacitors, the foil may corrode, when a voltage is applied. This corrosion causes an extremely high leakage current, which results in venting and an open circuit defect.

All other cleaning processes and cleaning agents are not approved by Würth Elektronik eiSos. All cleaning methods need to be tested and validated by the customer.

Adhesives and Coating Materials:

The usage of any adhesive or coating material, which is containing halogenated solvents, is not allowed. Before applying adhesives or coating materials, make sure that the following points are fulfilled:

- Take care that the surface and capacitor is dry and clean before applying adhesive or coating, to avoid any contamination with flux residues or cleaning solvents.
- Assure that no flux residue or spot is left between the rubber seal material of the capacitor and the PCB.
- Do not fully cover the entire rubber seal surface with adhesive, coating or molding materials. Otherwise the covering of the full rubber seal surface may restrain the natural diffusion of hydrogen gas. Block maximum 80% of the sealed section of a capacitor.
- If the used adhesive, coating or molding material is containing halogen ions in a large amount, the halogen ions can diffuse and creep into the capacitor and can damage the capacitor. Both above explained circumstances can result in serious failures.
- Follow the specified heating and curing instructions given by supplier of the used adhesive or coating material. Avoid excessive pressure or heat on the capacitor by applying coating or adhesive.
- Take care that hardening of adhesive, coating material was correctly done, so that no solvents do remain.
- Be aware, that used solvents within adhesive and coating materials can damage the sleeve of the capacitor and can result in changes of the appearance of the sleeve (color, shine and marking).

Mechanical Stress on lead wire and terminal:

Do not stress the capacitor with the following actions:

- Applying any excessive force to the lead wire or terminal.
- Move or turn the capacitor after soldering to the PCB.
- Bending pins after soldering.
- Carrying the PCB by picking / holding the board via a capacitor.

Operation and Usage of the Capacitor:

In operation and usage take care about the following points. Do not use the capacitor within the following environmental conditions:

- Environment with high mechanical stress / shocks or vibration (please see this specific datasheet for permitted limits).
- Environment with high amount of damp condensation, water or types of oil.
- Direct sunlight, ozone, any kind of radiation or ultraviolet rays.
- Toxic gases (e.g. ammonium, chlorine and compounds, bromine and compounds, hydrogen sulfide, sulfuric acid).

User should never touch the terminals of the capacitor directly. Avoid short circuit between terminals with any kind of conductive material (e.g. metal, fluid, acid, alkaline solution).

Maintenance:

For industrial applications it is recommended to perform periodic inspections. Power supplies shall be turned off before inspection to discharge the capacitor. Check the following points in case of an inspection:

- Visual inspection of the capacitor to see, if the vent operated for pressure relief and if any leakage of electrolyte has taken place.
- Measurement of electrical characteristics of the capacitor (according to datasheet, especially leakage current, capacitance and ESR).

In case of deviation or failure according to the specified characteristics, take care to start appropriate actions (e.g. replacement of capacitor).

Emergency Case:

In case of excessive pressure within the capacitor the vent may operate and release this pressure. In case of vent operation gas becomes visible, when the component is in operation. If so, directly turn off the application and disconnect it from the power source. If the application will not be turned off, a possible short circuit of capacitor or a short circuit due to bridging of liquefied gas can possibly damage the circuit and in worst case the application may be dramatically damaged. Do not stay or position body or face above or in direction of the vent, because in the event of any vent operation, the releasing gas temperature may have over 100 °C. In case of contact with the electrolyte on skin, wash the skin immediately with soap and water. If the eyes will get in contact with the releasing gas, immediately wash the eyes with water. Whether the gas was inhaled, directly use gargle.

Disposal:

This capacitor shall be disposed of as industrial waste in accordance with local laws and regulations. Discharge capacitor before disposal. Never throw this device into fire. To avoid any explosion of capacitor, punch holes into the can or crush the capacitor before industrial waste incineration.

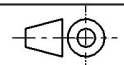
 <p>Würth Elektronik eiSos GmbH & Co. KG EMC & Inductive Solutions Max-Eyth-Str. 1 74638 Waldenburg Germany Tel. +49 (0) 79 42 945 - 0 www.we-online.com eiSos@we-online.com</p>	CHECKED	REVISION	DATE (YYYY-MM-DD)	GENERAL TOLERANCE	PROJECTION METHOD	
	ReKa	001.001	2019-01-29	DIN ISO 2768-1m		
	DESCRIPTION				TECHNICAL REFERENCE	
	WCAP-STSC Supercapacitors (EDLC's)				STP0820305Q2R7DSPB15000	
SIZE/TYPE				BUSINESS UNIT	STATUS	PAGE
8.0 x 20.0				eiCap	Valid	7/9
				ORDER CODE		
				850617030001		

These cautions and warnings comply with the state of the scientific and technical knowledge and are believed to be accurate and reliable. However, no responsibility is assumed for inaccuracies or incompleteness.

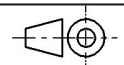
 <p>WÜRTH ELEKTRONIK</p>	CHECKED ReKa		REVISION 001.001	DATE (YYYY-MM-DD) 2019-01-29	GENERAL TOLERANCE DIN ISO 2768-1m	PROJECTION METHOD 	
	DESCRIPTION WCAP-STSC Supercapacitors (EDLC's)					TECHNICAL REFERENCE STP0820305Q2R7DSPB15000	
	SIZE/TYPE 8.0 x 20.0					BUSINESS UNIT eiCap	ORDER CODE 850617030001
Würth Elektronik eiSos GmbH & Co. KG EMC & Inductive Solutions Max-Eyth-Str. 1 74638 Waldenburg Germany Tel. +49 (0) 79 42 945 - 0 www.we-online.com eiSos@we-online.com					STATUS Valid	PAGE 8/9	

This electronic component has been designed and developed for usage in general electronic equipment only. This product is not authorized for use in equipment where a higher safety standard and reliability standard is especially required or where a failure of the product is reasonably expected to cause severe personal injury or death, unless the parties have executed an agreement specifically governing such use. Moreover Würth Elektronik eiSos GmbH & Co KG products are neither designed nor intended for use in areas such as military, aerospace, aviation, nuclear control, submarine, transportation (automotive control, train control, ship control), transportation signal, disaster prevention, medical, public information network etc.. Würth Elektronik eiSos GmbH & Co KG must be informed about the intent of such usage before the design-in stage. In addition, sufficient reliability evaluation checks for safety must be performed on every electronic component which is used in electrical circuits that require high safety and reliability functions or performance.

Important Notes

The following conditions apply to all goods within the product range of Würth Elektronik eiSos GmbH & Co. KG:

1. General Customer Responsibility

Some goods within the product range of Würth Elektronik eiSos GmbH & Co. KG contain statements regarding general suitability for certain application areas. These statements about suitability are based on our knowledge and experience of typical requirements concerning the areas, serve as general guidance and cannot be estimated as binding statements about the suitability for a customer application. The responsibility for the applicability and use in a particular customer design is always solely within the authority of the customer. Due to this fact it is up to the customer to evaluate, where appropriate to investigate and decide whether the device with the specific product characteristics described in the product specification is valid and suitable for the respective customer application or not.

2. Customer Responsibility related to Specific, in particular Safety-Relevant Applications

It has to be clearly pointed out that the possibility of a malfunction of electronic components or failure before the end of the usual lifetime cannot be completely eliminated in the current state of the art, even if the products are operated within the range of the specifications. In certain customer applications requiring a very high level of safety and especially in customer applications in which the malfunction or failure of an electronic component could endanger human life or health it must be ensured by most advanced technological aid of suitable design of the customer application that no injury or damage is caused to third parties in the event of malfunction or failure of an electronic component. Therefore, customer is cautioned to verify that data sheets are current before placing orders. The current data sheets can be downloaded at www.we-online.com.

3. Best Care and Attention

Any product-specific notes, cautions and warnings must be strictly observed. Any disregard will result in the loss of warranty.

4. Customer Support for Product Specifications

Some products within the product range may contain substances which are subject to restrictions in certain jurisdictions in order to serve specific technical requirements. Necessary information is available on request. In this case the field sales engineer or the internal sales person in charge should be contacted who will be happy to support in this matter.

5. Product R&D

Due to constant product improvement product specifications may change from time to time. As a standard reporting procedure of the Product Change Notification (PCN) according to the JEDEC-Standard inform about minor and major changes. In case of further queries regarding the PCN, the field sales engineer or the internal sales person in charge should be contacted. The basic responsibility of the customer as per Section 1 and 2 remains unaffected.

6. Product Life Cycle

Due to technical progress and economical evaluation we also reserve the right to discontinue production and delivery of products. As a standard reporting procedure of the Product Termination Notification (PTN) according to the JEDEC-Standard we will inform at an early stage about inevitable product discontinuance. According to this we cannot guarantee that all products within our product range will always be available. Therefore it needs to be verified with the field sales engineer or the internal sales person in charge about the current product availability expectancy before or when the product for application design-in disposal is considered. The approach named above does not apply in the case of individual agreements deviating from the foregoing for customer-specific products.

7. Property Rights

All the rights for contractual products produced by Würth Elektronik eiSos GmbH & Co. KG on the basis of ideas, development contracts as well as models or templates that are subject to copyright, patent or commercial protection supplied to the customer will remain with Würth Elektronik eiSos GmbH & Co. KG. Würth Elektronik eiSos GmbH & Co. KG does not warrant or represent that any license, either expressed or implied, is granted under any patent right, copyright, mask work right, or other intellectual property right relating to any combination, application, or process in which Würth Elektronik eiSos GmbH & Co. KG components or services are used.

8. General Terms and Conditions

Unless otherwise agreed in individual contracts, all orders are subject to the current version of the "General Terms and Conditions of Würth Elektronik eiSos Group", last version available at www.we-online.com.

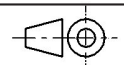
 <p>Würth Elektronik eiSos GmbH & Co. KG EMC & Inductive Solutions Max-Eyth-Str. 1 74638 Waldenburg Germany Tel. +49 (0) 79 42 945 - 0 www.we-online.com eiSos@we-online.com</p>	CHECKED	REVISION	DATE (YYYY-MM-DD)	GENERAL TOLERANCE	PROJECTION METHOD	
	ReKa	001.001	2019-01-29	DIN ISO 2768-1m		
	DESCRIPTION				TECHNICAL REFERENCE	
	WCAP-STSC Supercapacitors (EDLC's)				STP0820305Q2R7DSPB15000	
SIZE/TYPE				BUSINESS UNIT	STATUS	PAGE
8.0 x 20.0				eiCap	Valid	9/9
				ORDER CODE		
				850617030001		

Компания «Океан Электроники» предлагает заключение долгосрочных отношений при поставках импортных электронных компонентов на взаимовыгодных условиях!

Наши преимущества:

- Поставка оригинальных импортных электронных компонентов напрямую с производств Америки, Европы и Азии, а так же с крупнейших складов мира;
- Широкая линейка поставок активных и пассивных импортных электронных компонентов (более 30 млн. наименований);
- Поставка сложных, дефицитных, либо снятых с производства позиций;
- Оперативные сроки поставки под заказ (от 5 рабочих дней);
- Экспресс доставка в любую точку России;
- Помощь Конструкторского Отдела и консультации квалифицированных инженеров;
- Техническая поддержка проекта, помощь в подборе аналогов, поставка прототипов;
- Поставка электронных компонентов под контролем ВП;
- Система менеджмента качества сертифицирована по Международному стандарту ISO 9001;
- При необходимости вся продукция военного и аэрокосмического назначения проходит испытания и сертификацию в лаборатории (по согласованию с заказчиком);
- Поставка специализированных компонентов военного и аэрокосмического уровня качества (Xilinx, Altera, Analog Devices, Intersil, Interpoint, Microsemi, Actel, Aeroflex, Peregrine, VPT, Syfer, Eurofarad, Texas Instruments, MS Kennedy, Miteq, Cobham, E2V, MA-COM, Hittite, Mini-Circuits, General Dynamics и др.);

Компания «Океан Электроники» является официальным дистрибьютором и эксклюзивным представителем в России одного из крупнейших производителей разъемов военного и аэрокосмического назначения «JONHON», а так же официальным дистрибьютором и эксклюзивным представителем в России производителя высокотехнологичных и надежных решений для передачи СВЧ сигналов «FORSTAR».



JONHON

«JONHON» (основан в 1970 г.)

Разъемы специального, военного и аэрокосмического назначения:

(Применяются в военной, авиационной, аэрокосмической, морской, железнодорожной, горно- и нефтедобывающей отраслях промышленности)

«FORSTAR» (основан в 1998 г.)

ВЧ соединители, коаксиальные кабели,
кабельные сборки и микроволновые компоненты:

(Применяются в телекоммуникациях гражданского и специального назначения, в средствах связи, РЛС, а так же военной, авиационной и аэрокосмической отраслях промышленности).



Телефон: 8 (812) 309-75-97 (многоканальный)

Факс: 8 (812) 320-03-32

Электронная почта: ocean@oceanchips.ru

Web: <http://oceanchips.ru/>

Адрес: 198099, г. Санкт-Петербург, ул. Калинина, д. 2, корп. 4, лит. А