

CMOS LDO Regulators for Portable Equipments



3ch CMOS LDO Regulators

BU6650NUX, BU6651NUX, BU6652NUX, BU6653NUX, BU6654NUX, BU6655NUX No.11020EET06

●Description

BU6650NUX, BU6651NUX, BU6652NUX, BU6653NUX, BU6654NUX, BU6655NUX are high-performance 3ch FULL CMOS regulator with 200-mA outputs, which is mounted on small package VSON008X2030(2.0 mm × 3.0 mm × 0.6 mm). It has excellent noise characteristics and load responsiveness characteristics despite its low circuit current consumption of 120 μA. It is most appropriate for various applications such as power supplies for logic IC, RF, and camera modules.

●Features

- 1) High-accuracy output voltage of ±1% (±25 mV on 1.5 V & 1.8 V products)
- 2) High ripple rejection: 70 dB (Typ., 1 kHz, VOUT ≤ 1.8 V)
- 3) Compatible with small ceramic capacitor (CIN=2.2μF, Co=1.0 μF)
- 4) Low current consumption: 120 μA
- 5) ON/OFF control pin (STBY) of output voltage
- 6) With built-in over current protection circuit and thermal shutdown circuit
- 7) With built-in output discharge circuit
- 8) Adopting small package VSON008X2030

●Applications

Battery-powered portable equipment, etc.

●Line up matrix

■ 200 mA BU665□NUX Series

Product Name	VOUT1	VOUT2	VOUT3	Package
BU6650NUX	2.8V	2.8V	1.8V	VSON008X2030
BU6651NUX	2.8V	1.8V	1.5V	
BU6652NUX	2.8V	2.8V	1.5V	
BU6653NUX	2.8V	1.8V	1.8V	
BU6654NUX	3.3V	1.8V	1.5V	
BU6655NUX	3.3V	2.8V	1.8V	

● Absolute maximum rating

Parameter	Symbol	Ratings	Unit
Maximum applied power voltage	VMAX	-0.3 ~ +6.0	V
Power dissipation	Pd	660* ¹	MW
Maximum junction temperature	TjMAX	+125	°C
Operational temperature range	Topr	-40 ~ +85	°C
Storage temperature range	Tstg	-55 ~ +125	°C

*1 PCB (70 mm × 70 mm, thickness 1.6-mm glass epoxy) a standard ROHM board is implemented. Reduced to 6.6 mW/°C when used at Ta=25°C or higher.

● Recommended operating range (Do not exceed Pd.)

Parameter	Symbol	Ratings	Unit
Input power supply voltage	VIN	2.5 ~ 5.5	V
Maximum output current	IMAX	200	mA

● Recommended operating conditions

Parameter	Symbol	Ratings			Unit	Conditions
		Min.	TYP.	Max.		
Input capacitor	CIN	1.0* ²	2.2	—	μF	A ceramic capacitor is recommended.
Output capacitor	Co	0.5* ²	1.0	—	μF	A ceramic capacitor is recommended.

*2 Set the capacity value of the capacitor so that it does not fall below the minimum value, taking temperature characteristics, DC device characteristics, and change with time into consideration.

●Electrical characteristics

(Ta=25°C, VIN=VOUT+1.0 V (VIN=3.5 V on VOUT=1.8 V and 1.5 V products), STBY=1.5 V, CIN=2.2 μF, CO=1.0 μF, unless otherwise specified)

Parameter	Symbol	Limits			Unit	Conditions	
		Min.	Typ.	Max.			
Output voltage	VOUT	VOUT ×0.99	VOUT	VOUT ×1.01	V	IOUT=10 μA, VOUT≥2.5 V	
		VOUT -25mV		VOUT +25mV		IOUT=10 μA, VOUT<2.5 V	
Operating current	IIN1	-	40	95	μA	IOUT=0mA STBY×1=1.5V, STBY×2=0V	
	IIN2	-	80	190	μA	IOUT=0mA STBY×2=1.5V, STBY×1=0V	
	IIN3	-	120	285	μA	IOUT=0mA STBY×3=1.5V	
Circuit current (at STBY)	ISTBY	-	-	1	μA	STBY=0 V	
Ripple rejection	RR	55	70	-	dB	VRR=-20dBv, fRR=1kHz, IOUT=10 mA 1.5 V ≤ VOUT ≤ 1.8 V	
			65			VRR=-20dBv, fRR=1 kHz, IOUT=10 mA 2.5 V ≤ VOUT	
Input / Output voltage difference	VSAT	-	360	720	mV	VOUT=2.8V (VIN=0.98*VOUT, IOUT=200 mA)	
		-	300	600		VOUT=3.3V (VIN=0.98*VOUT, IOUT=200 mA)	
		-	220	460		VOUT=3.3V (VIN=0.98*VOUT, IOUT=150 mA)	
Line regulation	VDL	-	2	20	mV	VIN=VOUT+1.0 V to 5.5 V, IOUT=10 μA	
Load regulation	VDLO	-	10	80	mV	IOUT=0.01 mA to 100 mA	
Over current protection detection current	ILMAX	220	350	700	mA	Vo=VOUT*0.8	
Output short-circuit current	ISHORT	20	70	150	mA	Vo=0 V	
Output discharge resistance	RDSC	20	50	80	Ω	VIN=4.0 V, STBY=0 V	
Standby pull down resistance	RSTB	500	1000	2000	kΩ		
Control Voltage	ON	VSTBH	1.5	-	5.5	V	Output Voltage ON
	OFF	VSTBL	-0.3	-	0.3	V	Output Voltage OFF

* This product does not have radiation-proof design.

●Block diagram, recommended circuit diagram, and package dimensions (VSON008X2030)

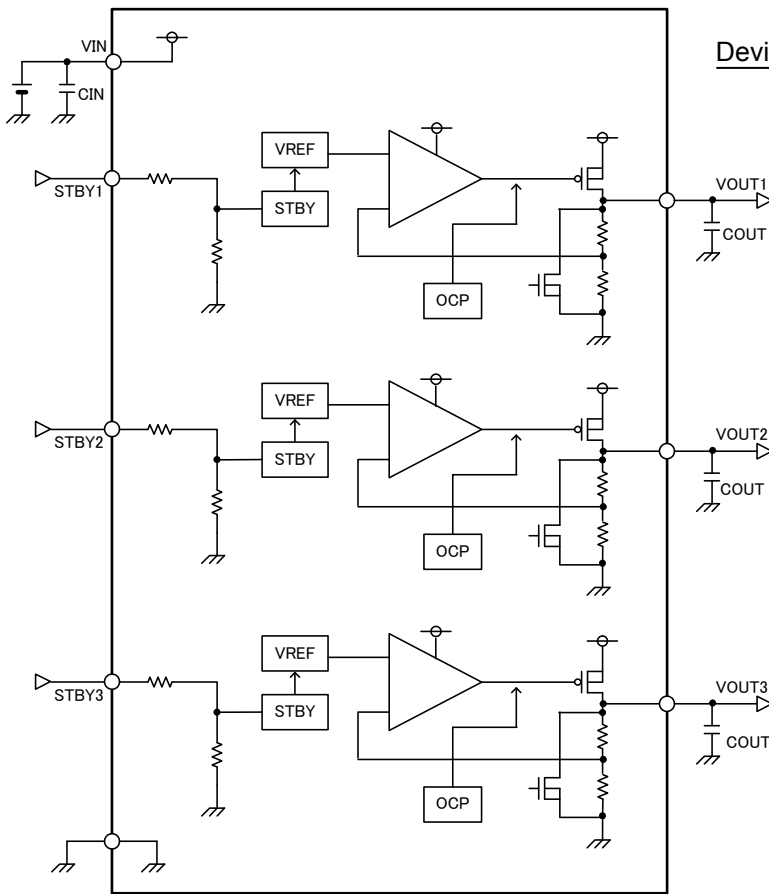

Fig.1 Block diagram

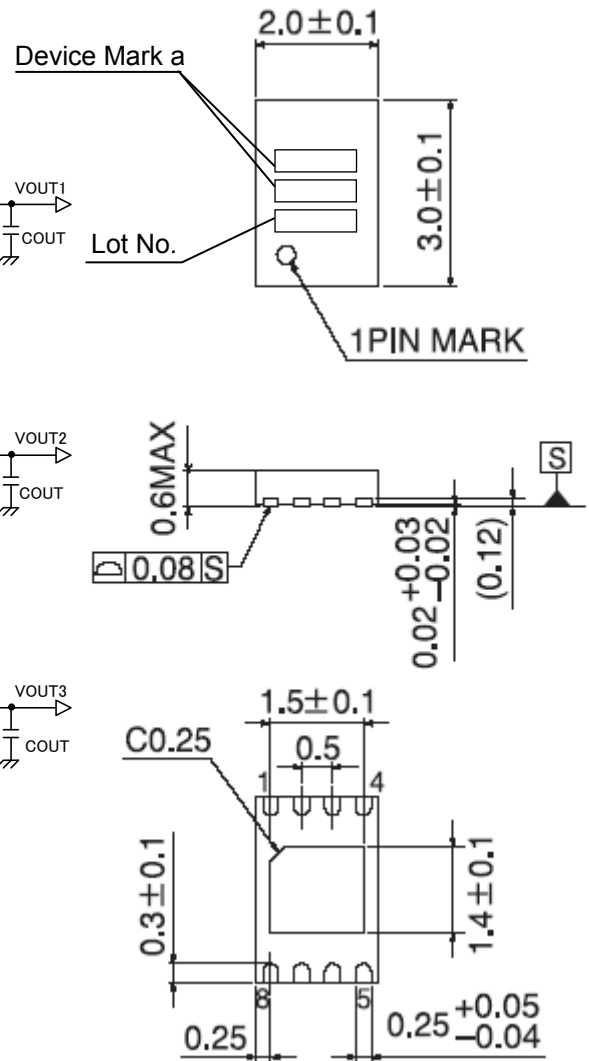

Fig.2 Package dimensions

●Pin configuration diagram

PIN No.	PIN NAME	DESCRIPTION
1	VIN	INPUT Pin
2	STBY1	OUTPUT1 CONTROL Pin (High : ON, Low : OFF)
3	STBY2	OUTPUT2 CONTROL Pin (High : ON, Low : OFF)
4	STBY3	OUTPUT3 CONTROL Pin (High : ON, Low : OFF)
5	GND	GROUND Pin
6	VOUT3	OUTPUT3 Pin
7	VOUT2	OUTPUT2 Pin
8	VOUT1	OUTPUT1 Pin

Device Mark	
Series Name	Device Mark a
BU6650NUX	U 6 6 5 0
BU6651NUX	U 6 6 5 1
BU6652NUX	U 6 6 5 2
BU6653NUX	U 6 6 5 3
BU6654NUX	U 6 6 5 4
BU6655NUX	U 6 6 5 5

● Input/Output terminal equivalent circuit schematic

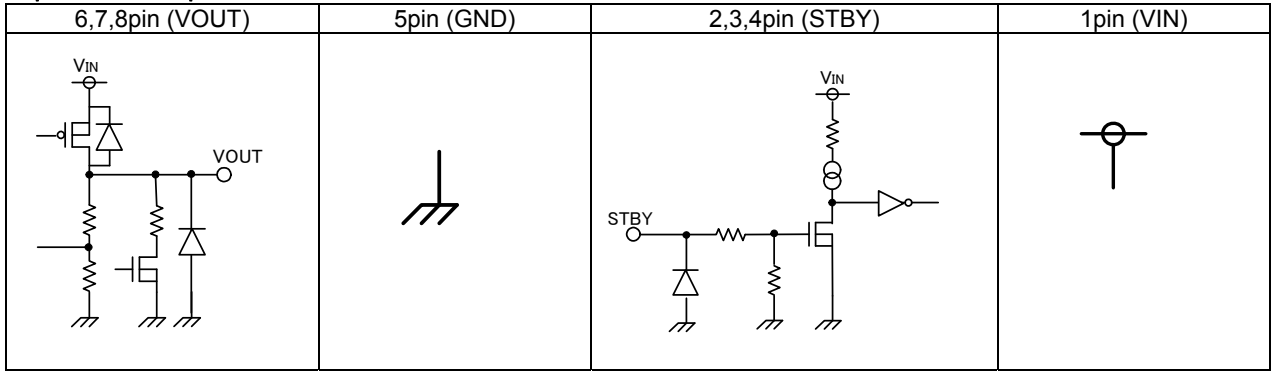

Fig.3 Input / Output equivalent circuit

● About input/output capacitor

It is recommended to place a capacitor as close as possible to the pins between the input terminal and GND or between the output terminal and GND.

The capacitor between the input terminal and GND becomes valid when source impedance increases or when wiring is long. The larger the capacity of the output capacitor between the output terminal and GND is, the better the stability and characteristics in output load fluctuation become. However, please check the status of actual implementation. Ceramic capacitors generally have variation, temperature characteristics, and direct current bias characteristics and the capacity value also decreases with time depending on the usage conditions. It is recommended to select a ceramic capacitor upon inquiring about detailed data of the related manufacturer.

Capacity value of ceramic capacitor - DC bias characteristics (Example)

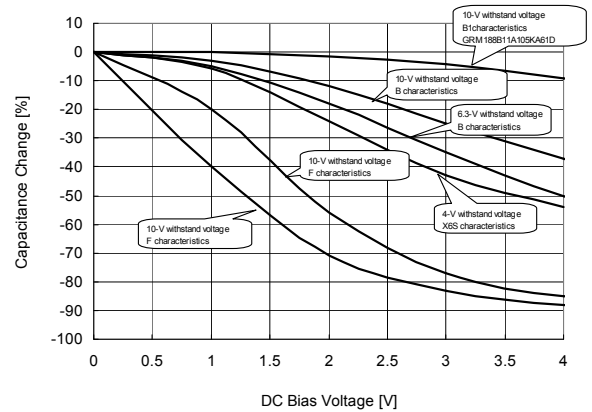

Fig.4 Capacity – bias characteristics

● About the equivalent series resistance (ESR) of a ceramic capacitor

Capacitors generally have ESR (equivalent series resistance) and it operates stably in the ESR-IOUT area shown on the right. Since ceramic capacitors, tantalum capacitors, electrolytic capacitors, etc. generally have different ESR, please check the ESR of the capacitor to be used and use it within the stability area range shown in the right graph for evaluation of the actual application.

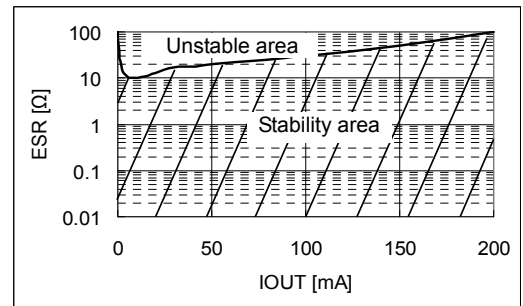

Fig.5 Stability area characteristics (Example)

●Reference data total device (Ta=25°C unless otherwise specified.)

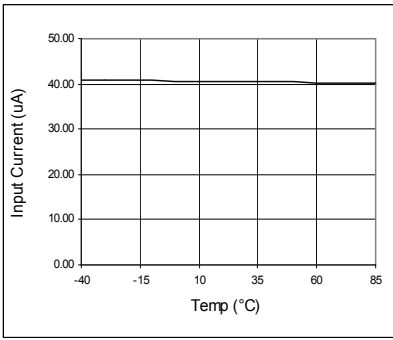

Fig. 6 lin1 vs. Temp

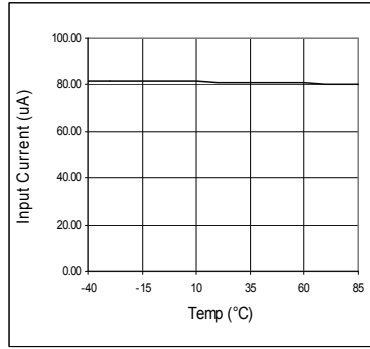

Fig. 7 lin2 vs. Temp

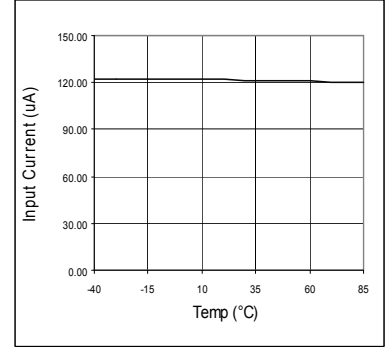

Fig. 8 lin3 vs. Temp

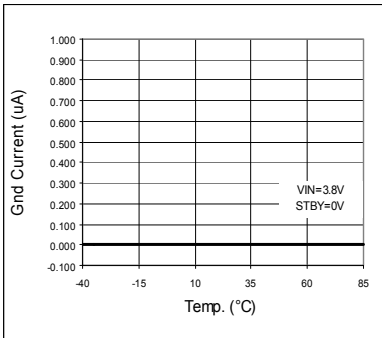

Fig. 9 Istby vs Temp (STBY)

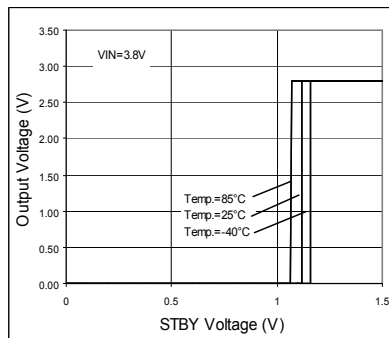

Fig. 10 STBY Threshold

●Reference data Vo=3.3V (Ta=25°C unless otherwise specified.)

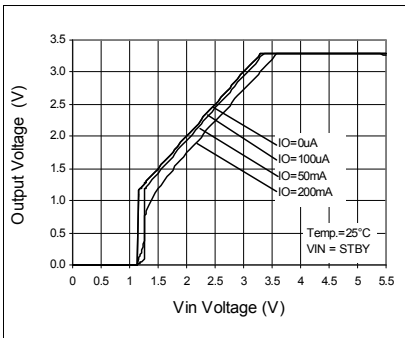

Fig. 11 Output Voltage

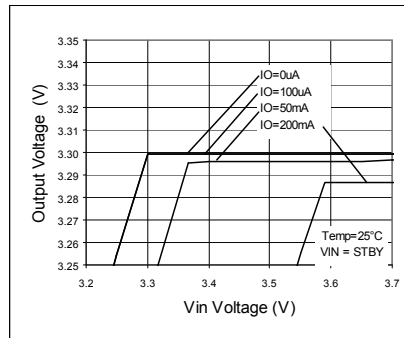

Fig. 12 Line Regulation

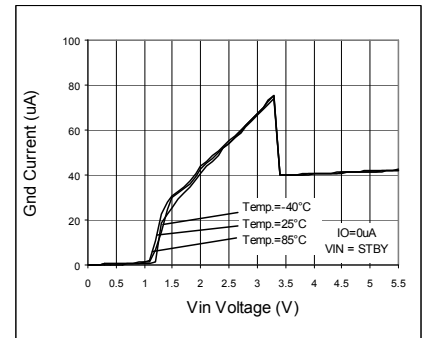

Fig. 13 Circuit Current IGND

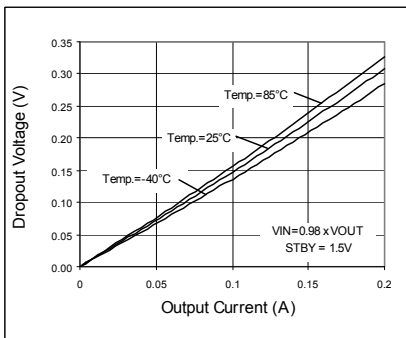

Fig. 14 Dropout Voltage

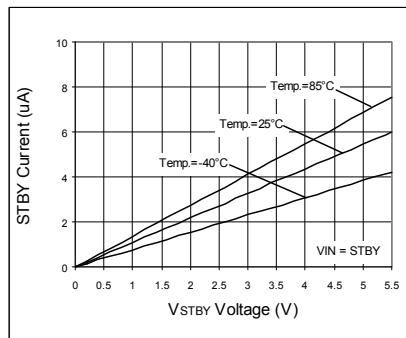

Fig. 15 STBY Input Current

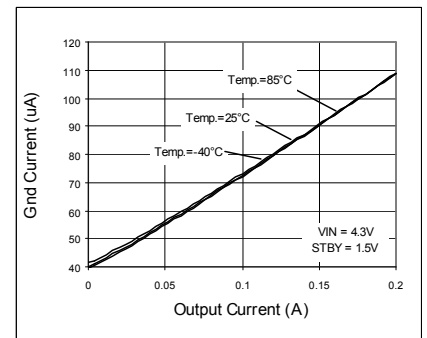

Fig. 16 IOUT - IGDND

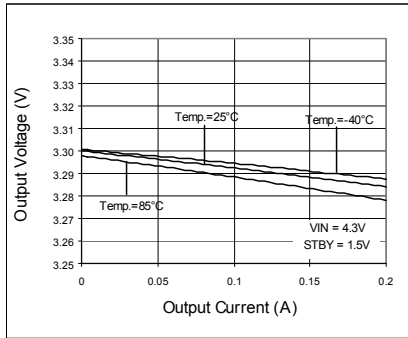

Fig. 17 Load Regulation

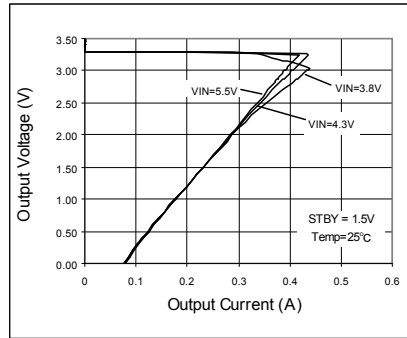

Fig. 18 OCP Threshold

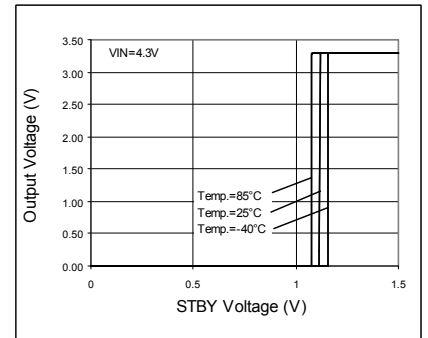

Fig. 19 STBY Threshold

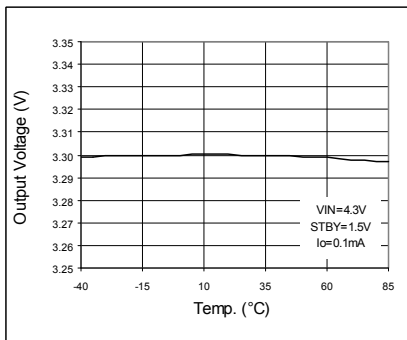

Fig. 20 VOUT vs Temp

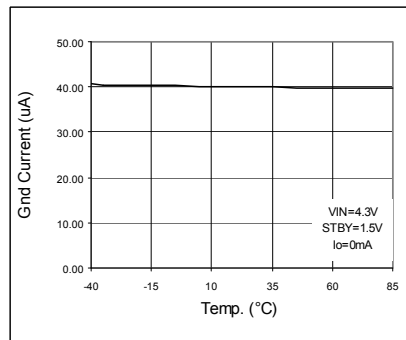

Fig. 21 IGND vs Temp

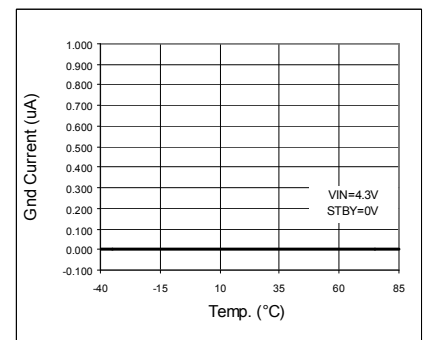

Fig. 22 IGND vs Temp (STBY)

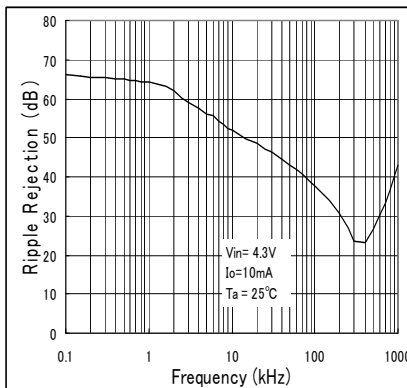

Fig. 23 Ripple Rejection VS Freq.

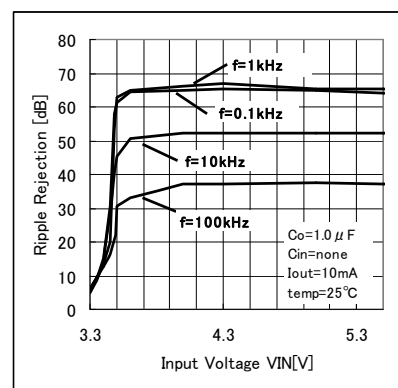

Fig. 24 Ripple Rejection VS VIN

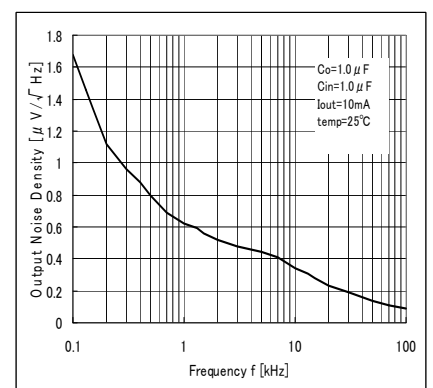

Fig. 25 Output Noise Spectral Density VS Freq.

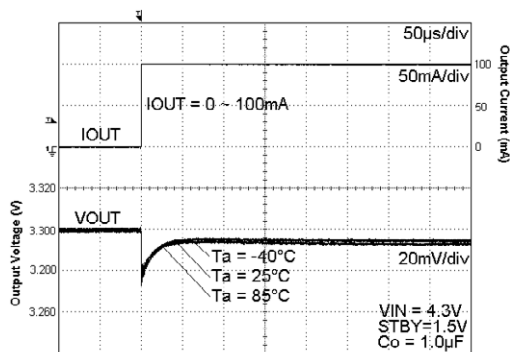

Fig. 26 Load Response

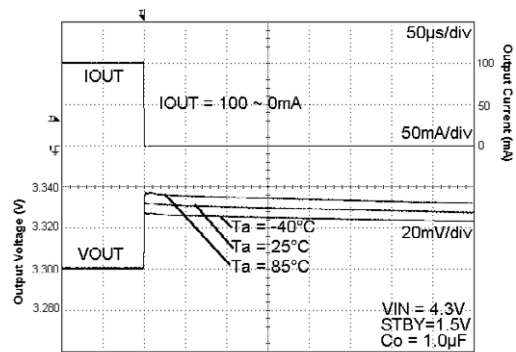

Fig. 27 Load Response

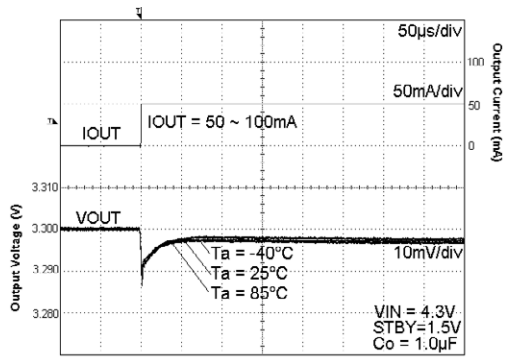

Fig. 28 Load Response

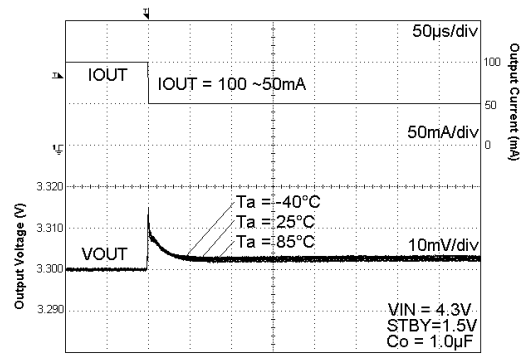

Fig. 29 Load Response

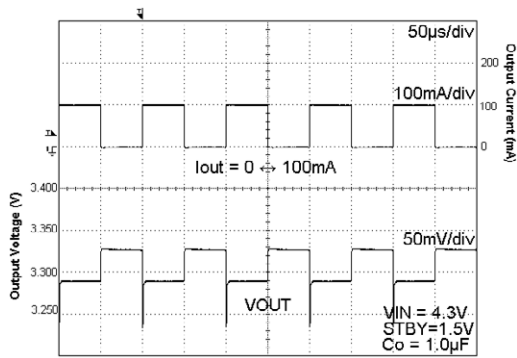

Fig. 30 Load Response
Current Pulse=10kHz

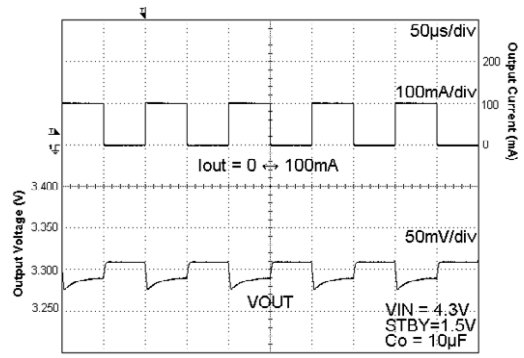

Fig. 31 Load Response
Current Pulse=10kHz

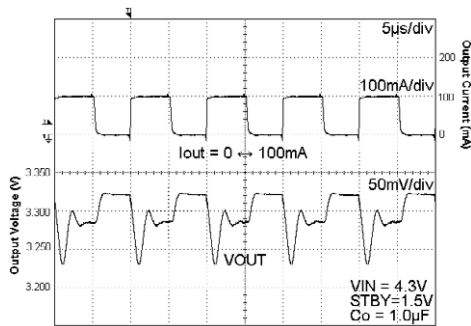

Fig. 32 Load Response
Current Pulse=100kHz

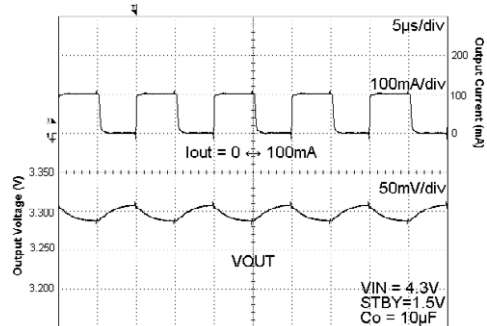

Fig. 33 Load Response
Current Pulse=100kHz

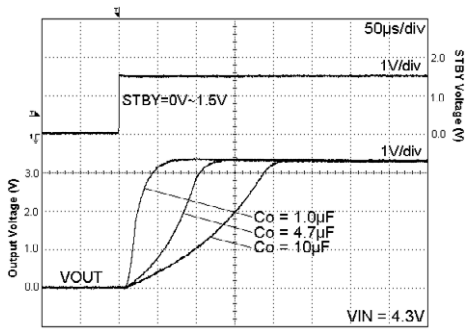

Fig. 34 Start Up Time
Iout = 0mA

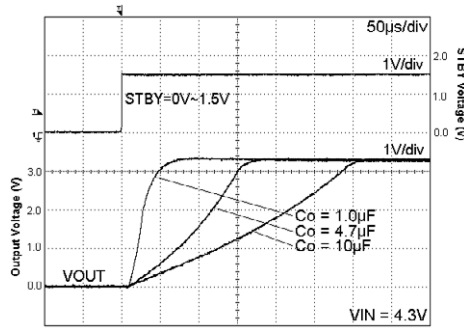

Fig. 35 Start Up Time
Iout = 200mA

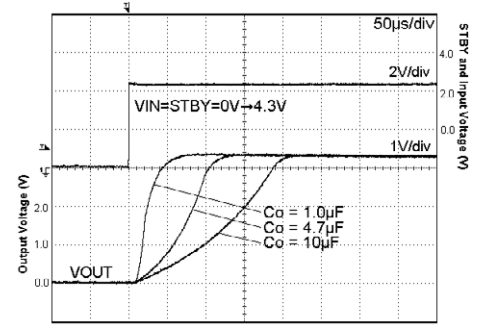

Fig. 36 Start Up Time (STBY=VIN)
Iout = 0mA

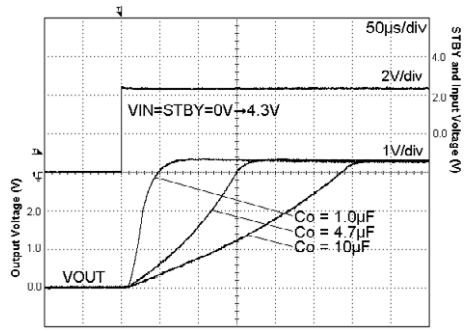

Fig. 37 Start Up Time (STBY=VIN)
Iout = 200mA

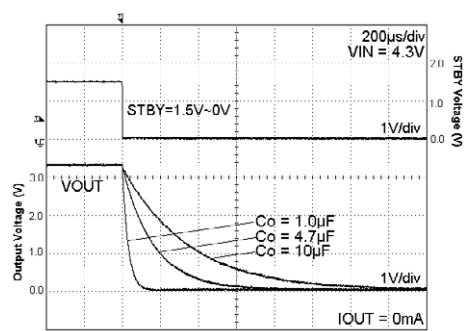

Fig. 38 Discharge Time
Iout = 0mA

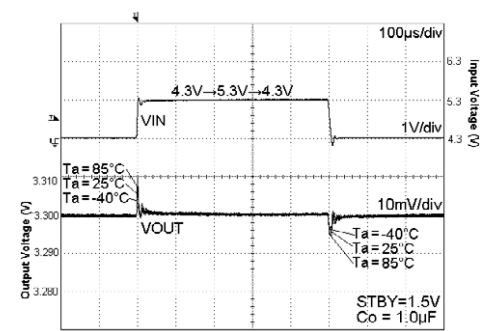

Fig. 39 VIN Response
Iout = 10mA

●Reference data $V_o=2.8V$ ($T_a=25^\circ C$ unless otherwise specified.)

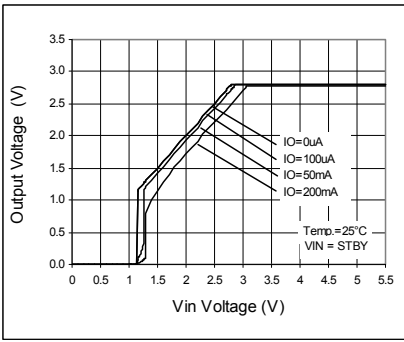

Fig. 40 Output Voltage

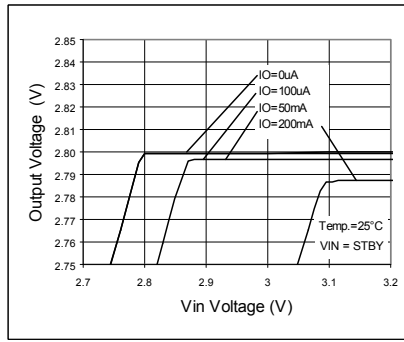

Fig. 41 Line Regulation

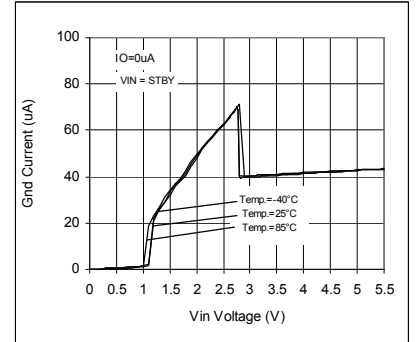

Fig. 42 Circuit Current IGND

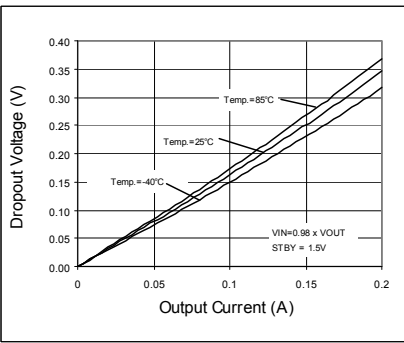

Fig. 43 Dropout Voltage

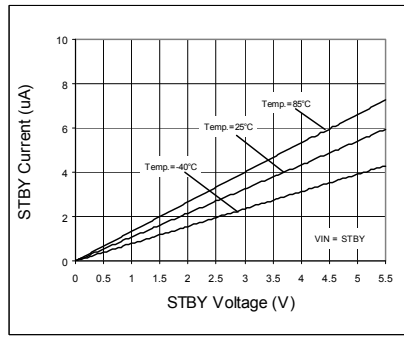

Fig. 44 STBY Input Current

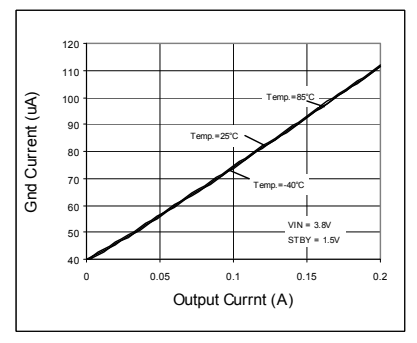

Fig. 45 IOOUT - IGND

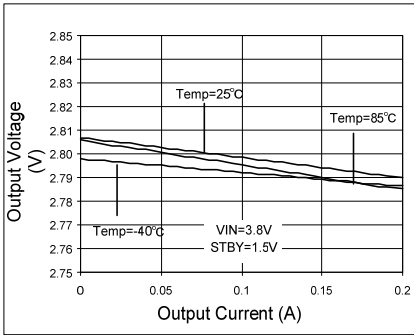

Fig. 46 Load Regulation

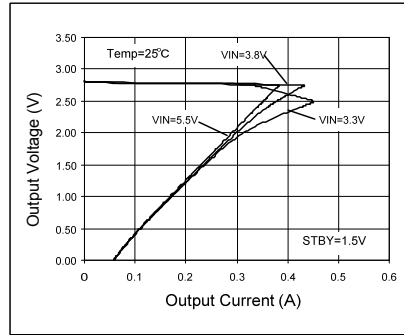

Fig. 47 OCP Threshold

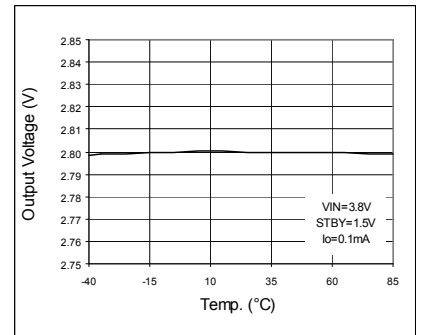

Fig. 48 VOUT vs Temp

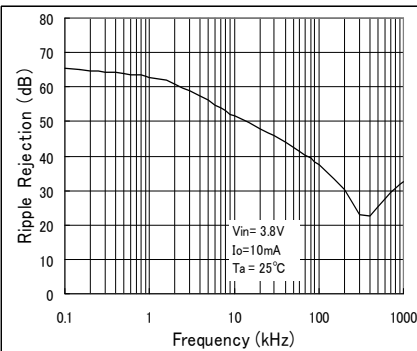

Fig. 49 Ripple Rejection VS Freq.

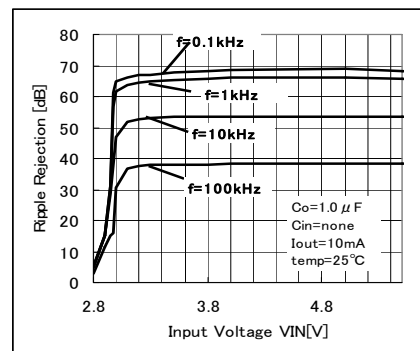

Fig. 50 Ripple Rejection VS VIN

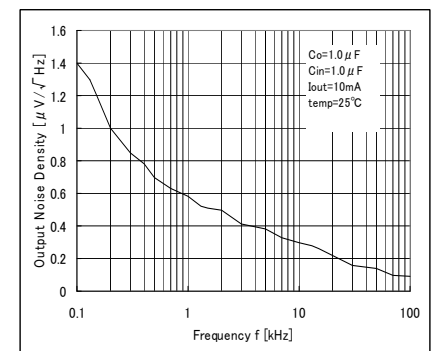

Fig. 51 Output Noise Spectral Density VS Freq.

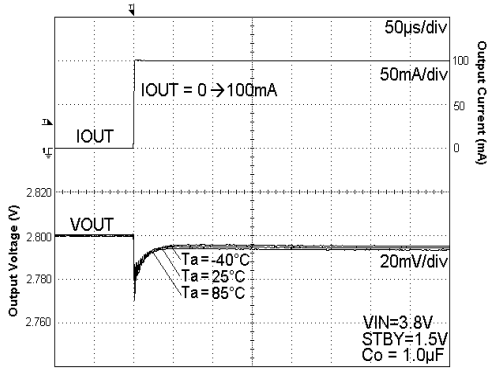

Fig. 52 Load Response

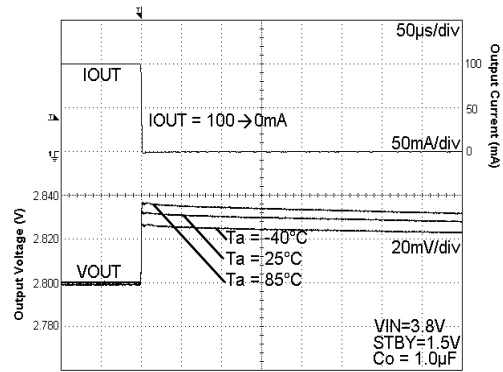

Fig. 53 Load Response

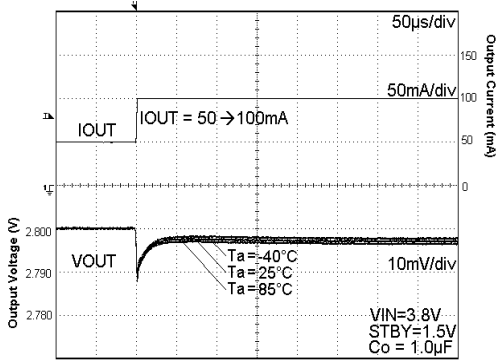

Fig. 54 Load Response

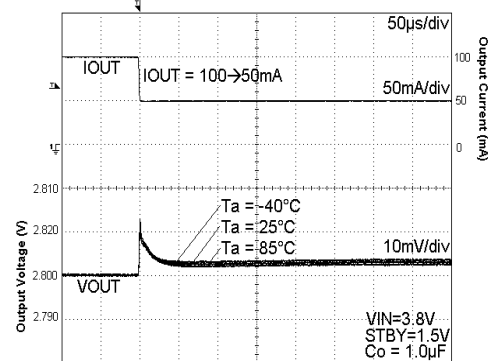

Fig. 55 Load Response

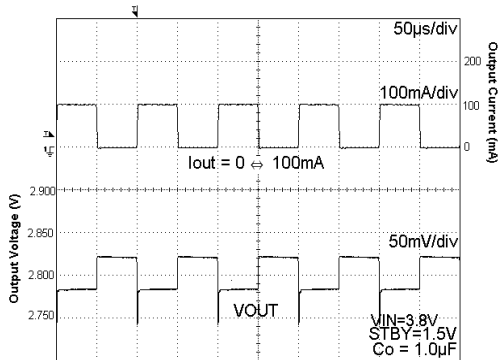

Fig. 56 Load Response
Current Pulse=10kHz

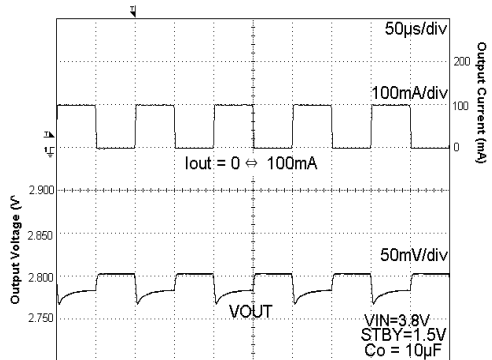

Fig. 57 Load Response
Current Pulse=10kHz

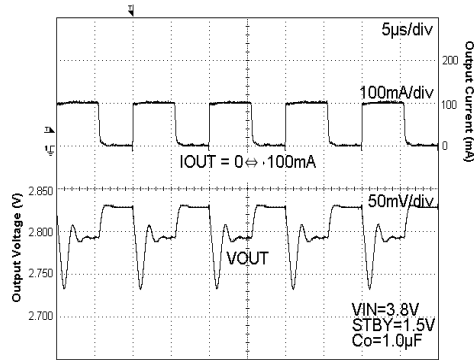

Fig. 58 Load Response
Current Pulse=100kHz

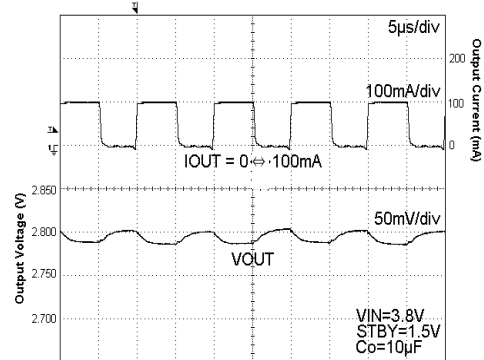

Fig. 59 Load Response
Current Pulse=100kHz

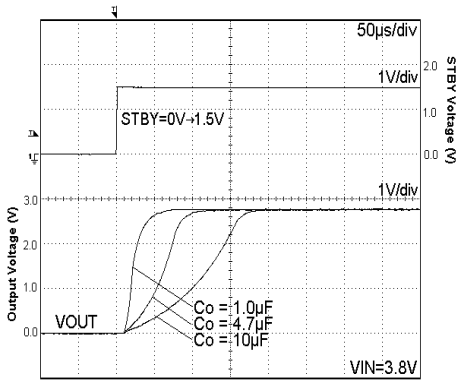

Fig. 60 Start Up Time
Iout = 0mA

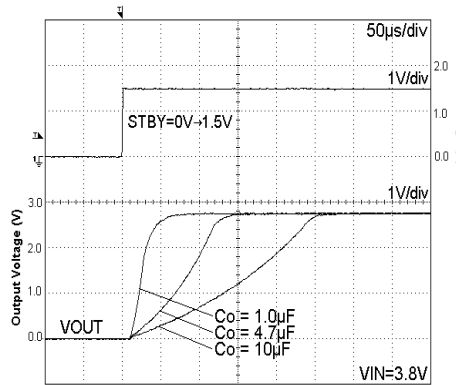

Fig. 61 Start Up Time
Iout = 200mA

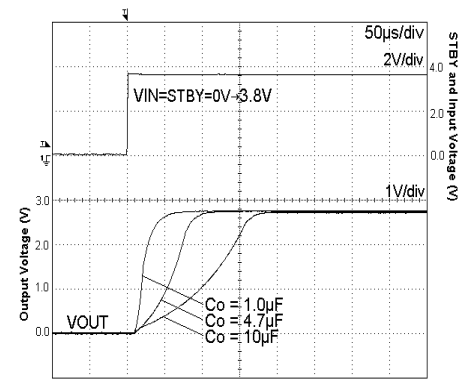

Fig. 62 Start Up Time (STBY=VIN)
Iout = 0mA

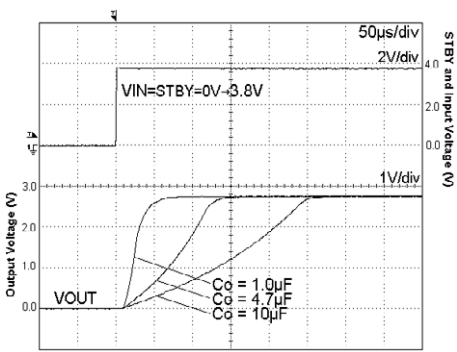

Fig. 63 Start Up Time (STBY=VIN)
Iout = 200mA

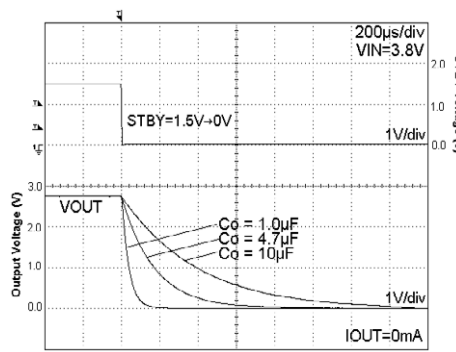

Fig. 64 Discharge Time
Iout = 0mA

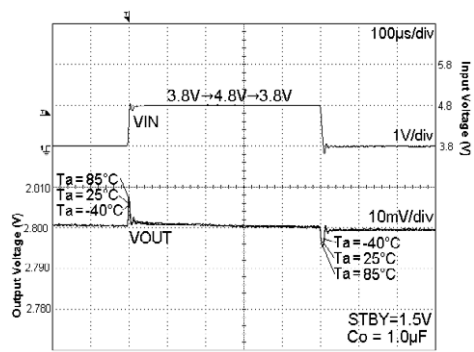

Fig. 65 VIN Response
Iout = 10mA

●Reference data $V_o=1.8V$ ($T_a=25^\circ C$ unless otherwise specified.)

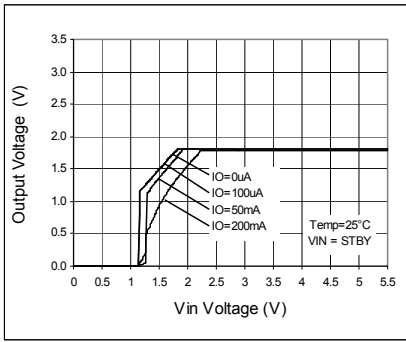

Fig. 66 Output Voltage

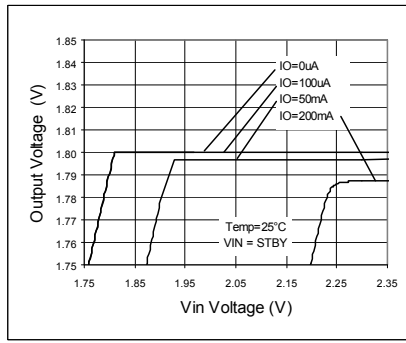

Fig. 67 Line Regulation

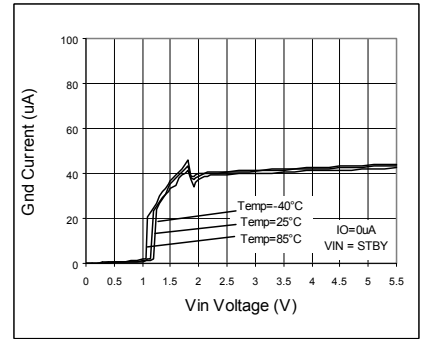

Fig. 68 Circuit Current IGND

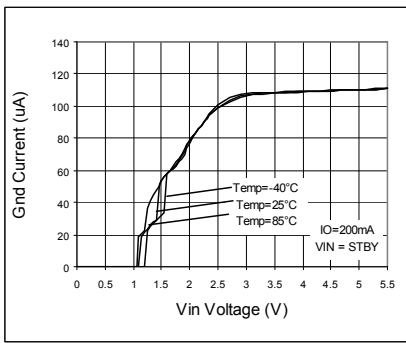

Fig. 69 Circuit Current IGND

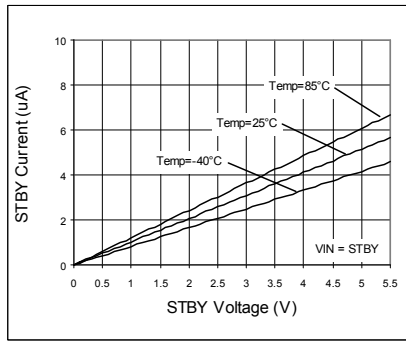

Fig. 70 STBY Input Current

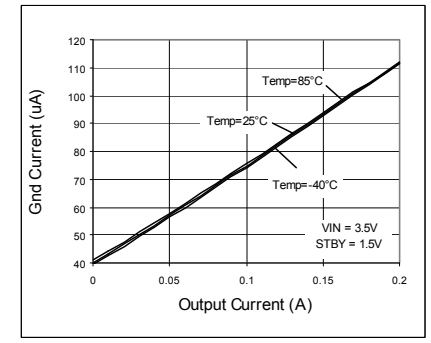

Fig. 71 IOU - IGND

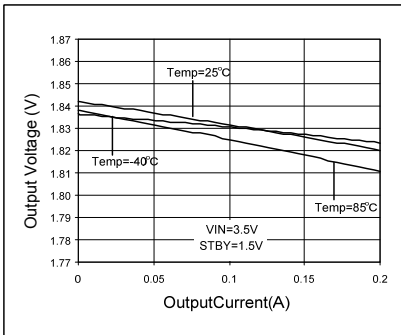

Fig. 72 Load Regulation

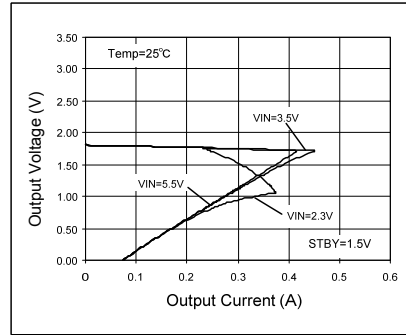

Fig. 73 OCP Threshold

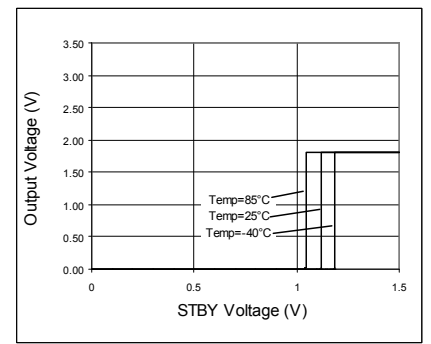

Fig. 74 STBY Threshold

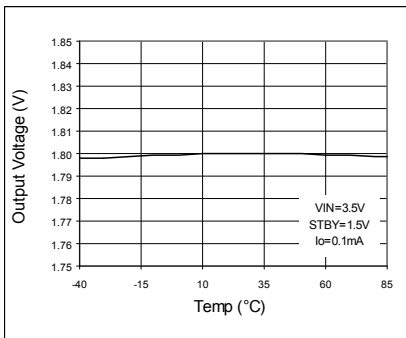

Fig. 75 VOUT vs. Temp

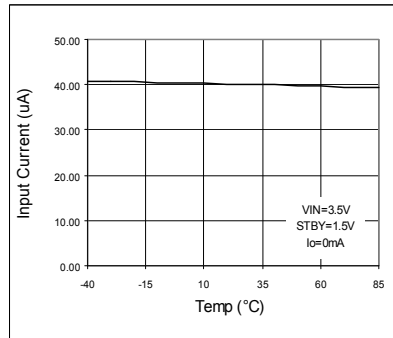

Fig. 76 IGND vs. Temp

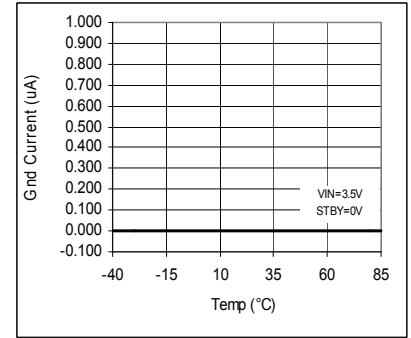

Fig. 77 IGND vs. Temp (STBY)

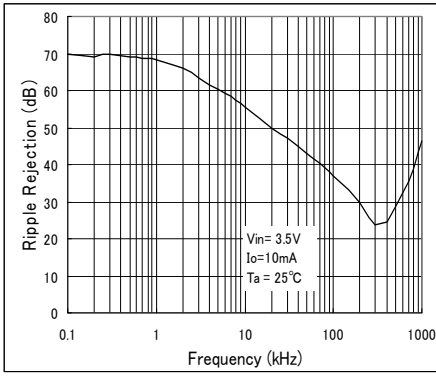

Fig. 78 Ripple Rejection VS Freq.

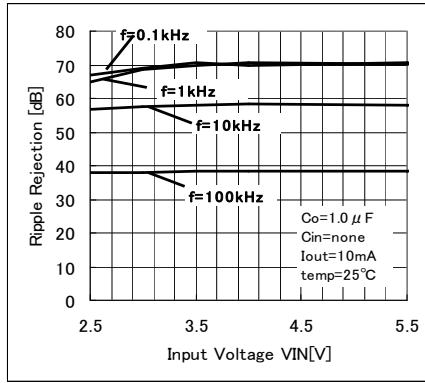

Fig. 79 Ripple Rejection VS VIN

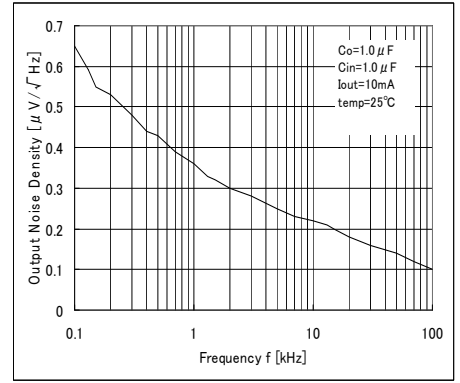

Fig. 80 Output Noise Spectral Density VS Freq.

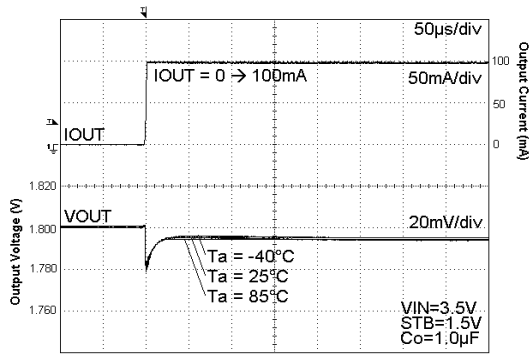

Fig. 81 Load Response

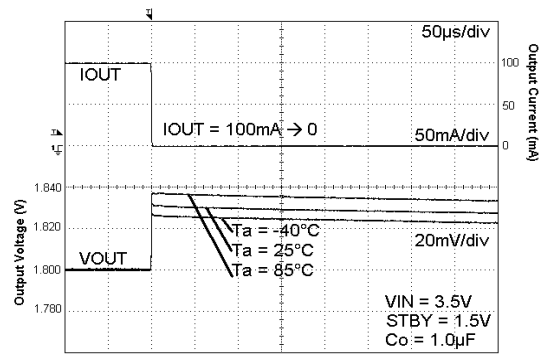

Fig. 82 Load Response

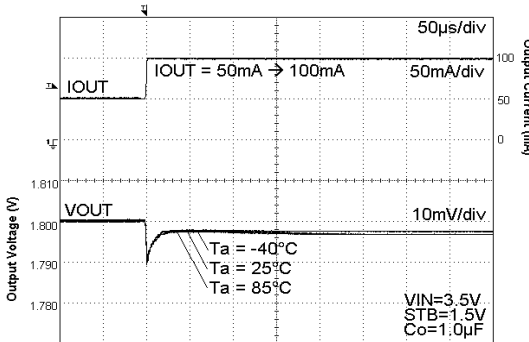

Fig. 83 Load Response

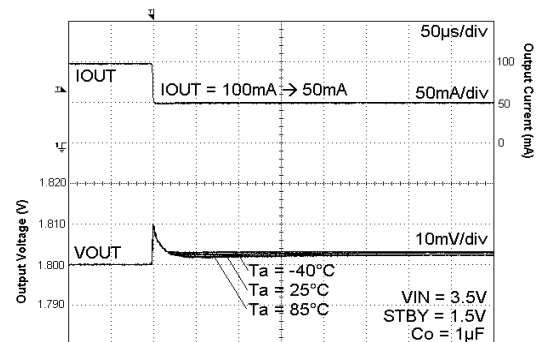

Fig. 84 Load Response

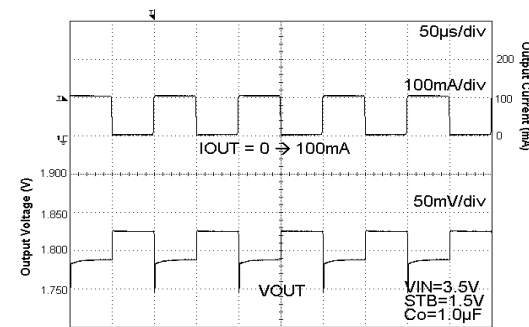

Fig. 85 Load Response Current Pulse=10kHz

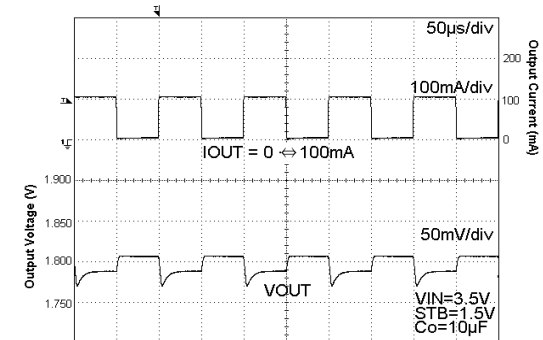

Fig. 86 Load Response Current Pulse=10kHz

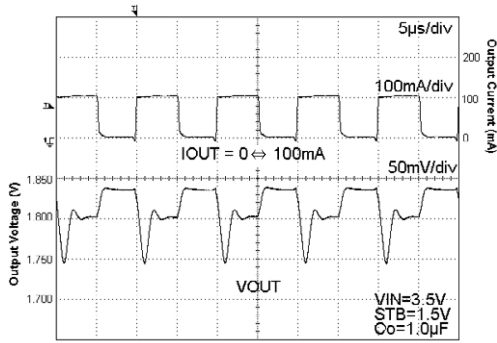

Fig. 87 Load Response
Current Pulse=100kHz

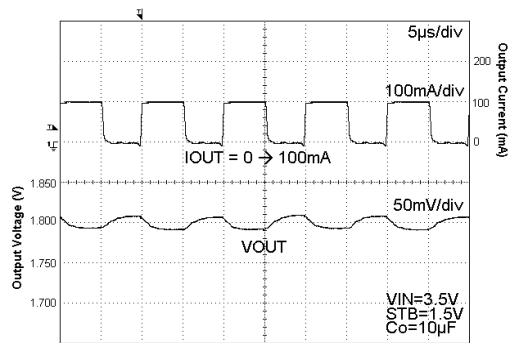

Fig. 88 Load Response
Current Pulse=100kHz

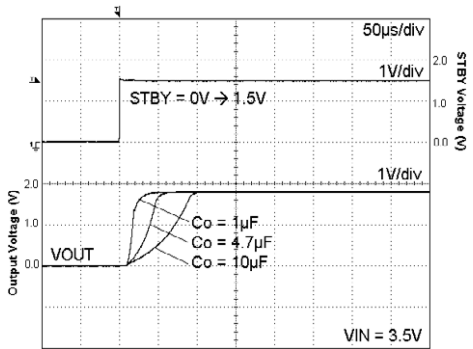

Fig. 89 Start Up Time
Iout = 0mA

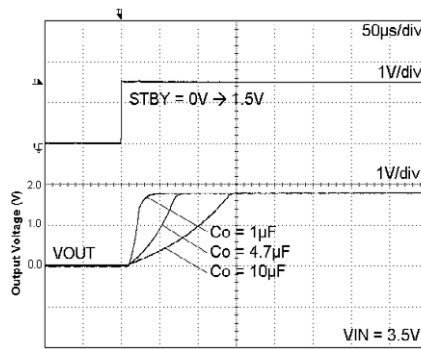

Fig. 90 Start Up Time
Iout = 200mA

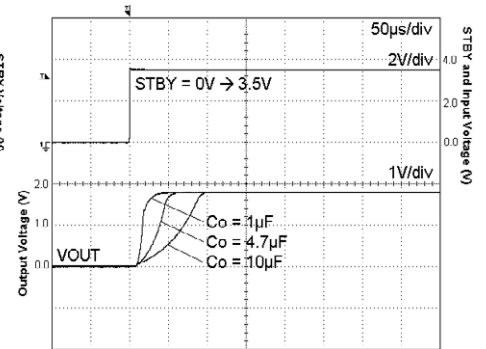

Fig. 91 Start Up Time (STBY=VIN)
Iout = 0mA

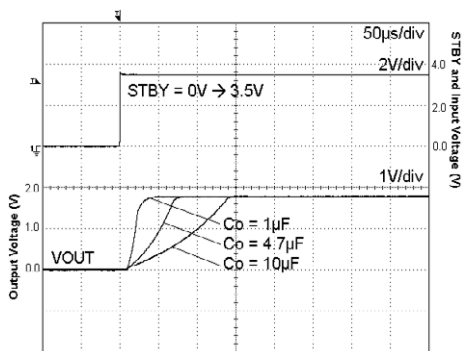

Fig. 92 Start Up Time (STBY=VIN)
Iout = 200mA

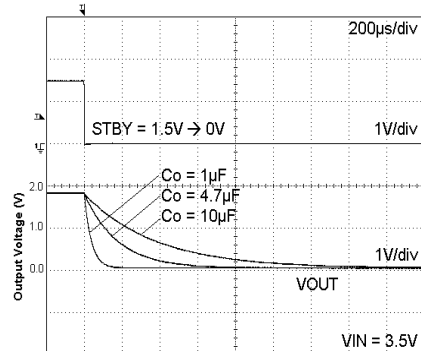

Fig. 93 Discharge Time
Iout = 0mA

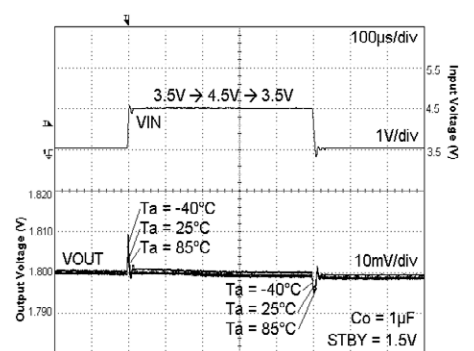

Fig. 94 VIN Response
Iout = 10mA

●Reference data $V_o=1.5V$ ($T_a=25^\circ C$ unless otherwise specified.)

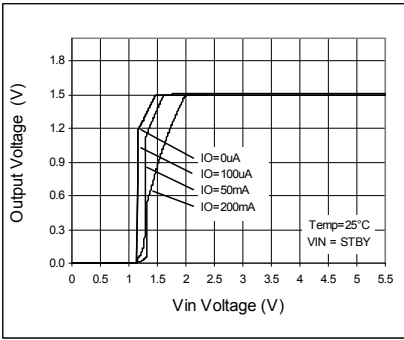

Fig. 95 Output Voltage

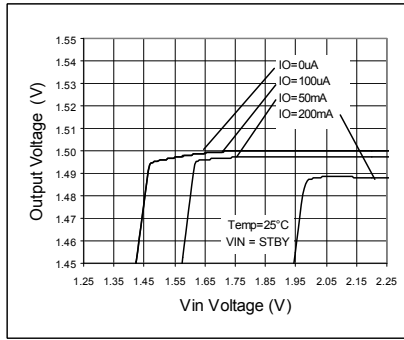

Fig. 96 Line Regulation

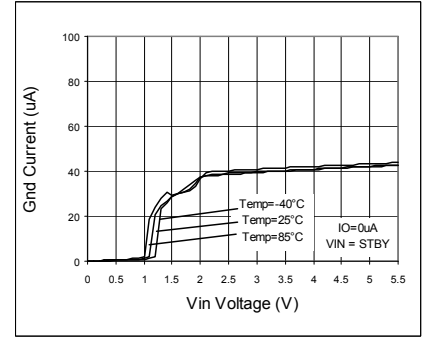

Fig. 97 Circuit Current IGND

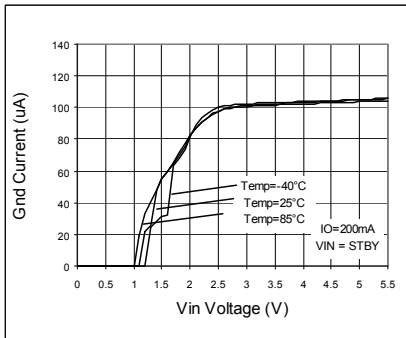

Fig. 98 Circuit Current IGND

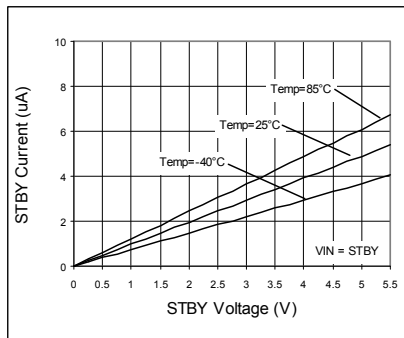

Fig. 99 STBY Input Current

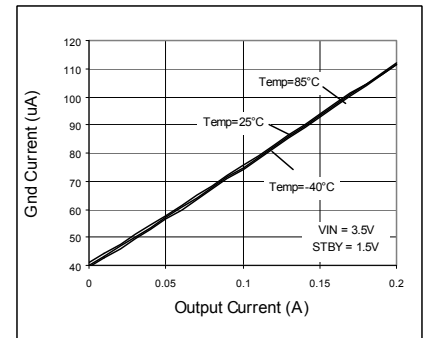

Fig. 100 IOOUT - IGND

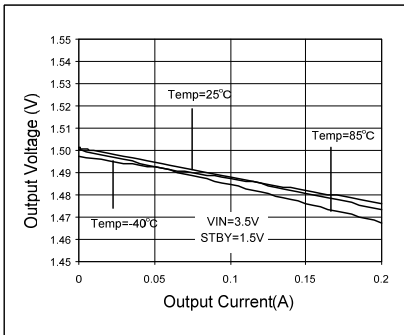

Fig. 101 Load Regulation

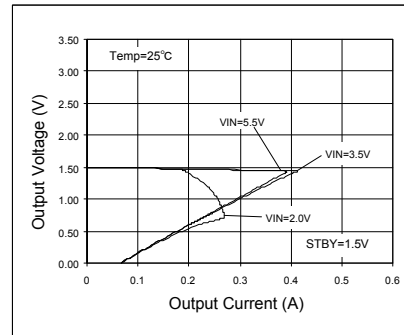

Fig. 102 OCP Threshold

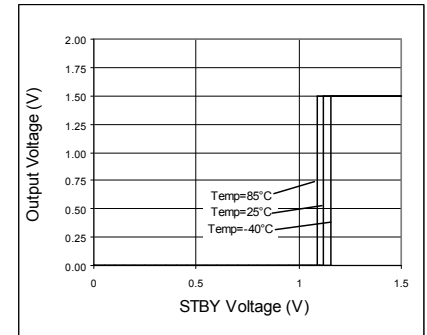

Fig. 103 STBY Threshold

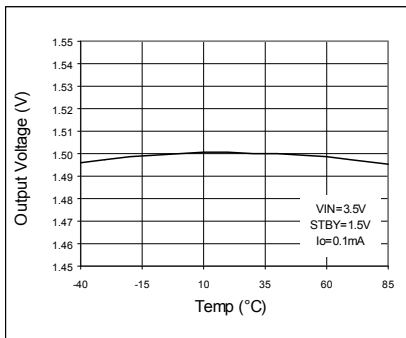

Fig. 104 VOUT vs. Temp

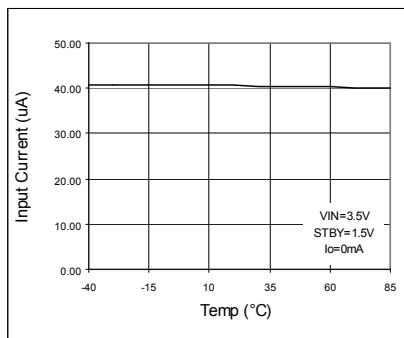

Fig. 105 IGND vs. Temp

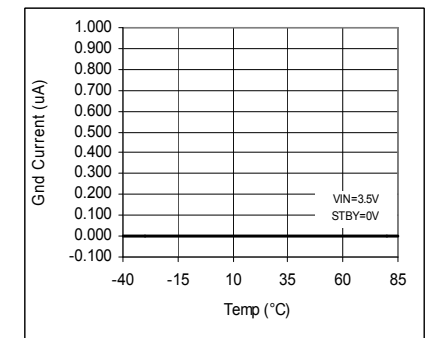

Fig. 106 IGND vs. Temp (STBY)

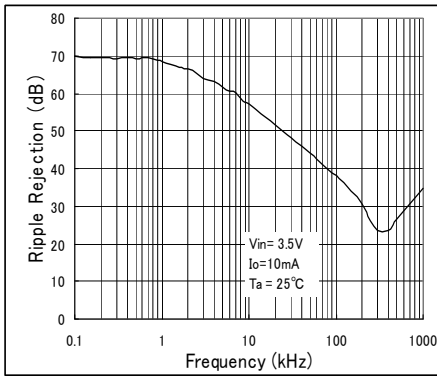

Fig. 107 Ripple Rejection vs. Freq.

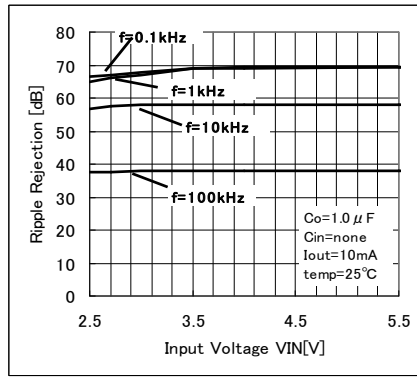

Fig. 108 Ripple Rejection vs. VIN (Iout=10 mA)

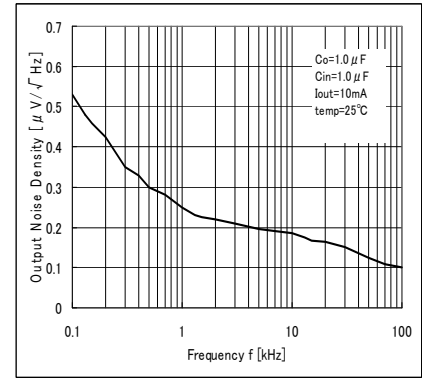

Fig. 109 Output Noise Spectral Density vs. Freq.

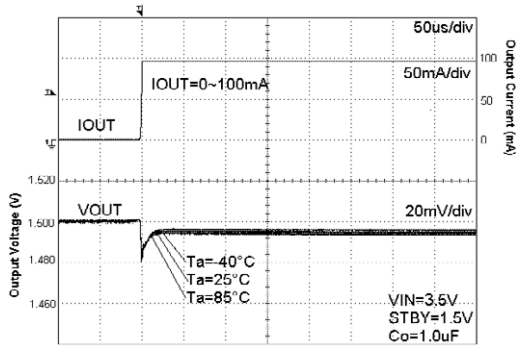

Fig. 110 Load Response

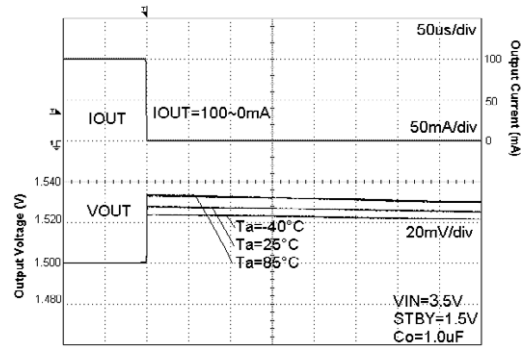

Fig. 111 Load Response

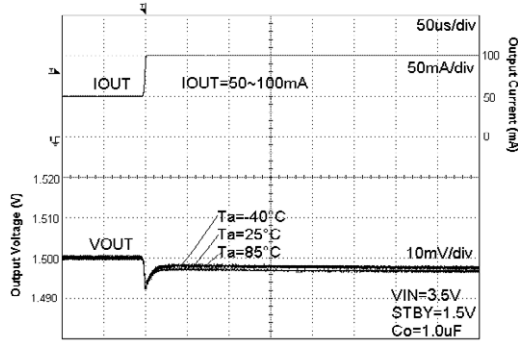

Fig. 112 Load Response

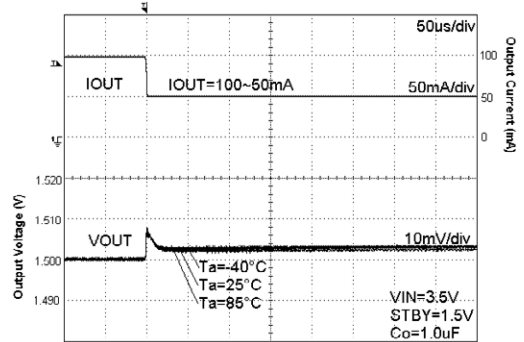

Fig. 113 Load Response

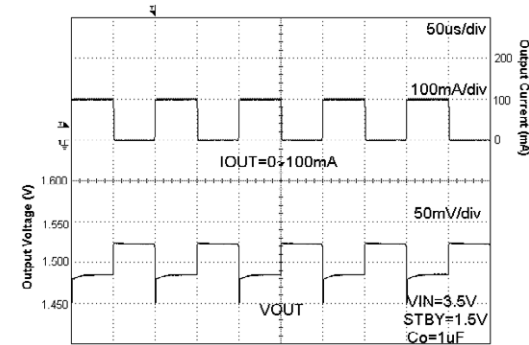

Fig. 114 Load Response
Current Pulse=10 kHz

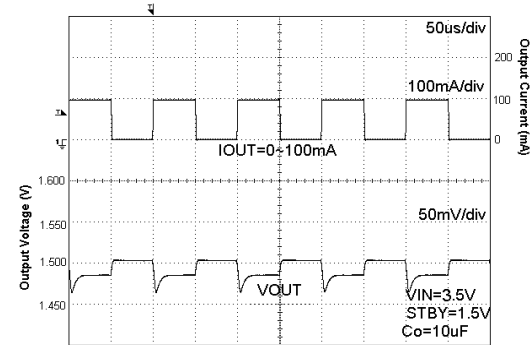

Fig. 115 Load Response
Current Pulse=10 kHz

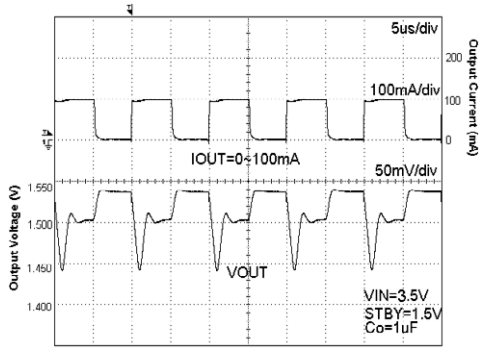

Fig. 116 Load Response
Current Pulse=100 kHz

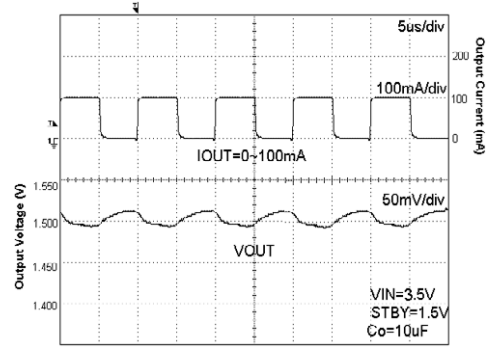

Fig. 117 Load Response
Current Pulse=100 kHz

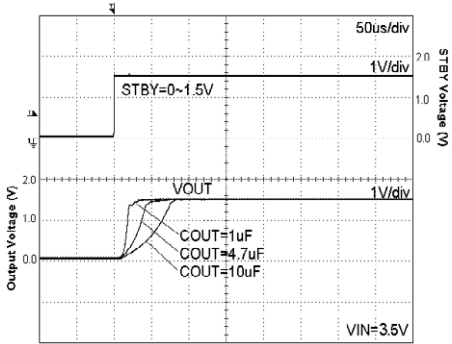

Fig. 118 Start-up Time
Iout = 0 mA

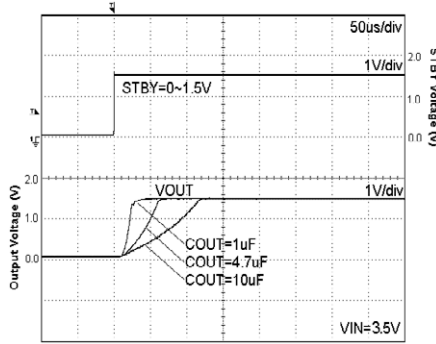

Fig. 119 Start-up Time
Iout = 200 mA

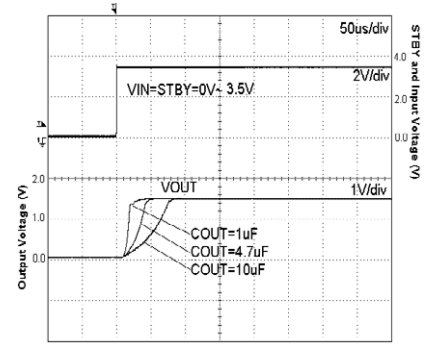

Fig. 120 Start-up Time (STBY=VIN)
Iout = 0 mA

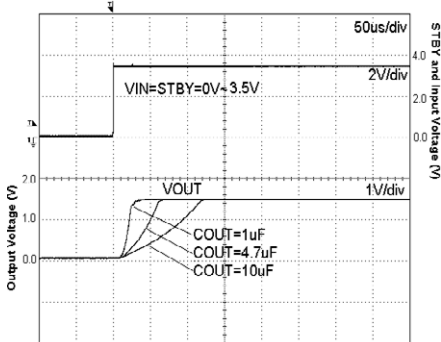

Fig. 121 Startup Time (STBY=VIN)
Iout = 200mA

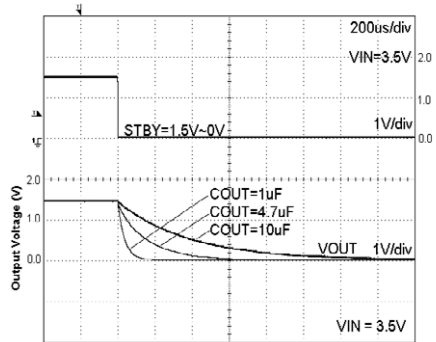

Fig. 122 Discharge Time
Iout = 0 mA

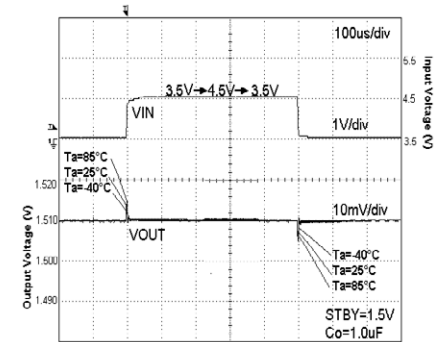

Fig. 123 VIN Response
Iout = 10 mA

●About power dissipation (Pd)

As for power dissipation, an approximate estimate of the heat reduction characteristics and internal power consumption of IC are shown, so please use these for reference. Since power dissipation changes substantially depending on the implementation conditions (board size, board thickness, metal wiring rate, number of layers and through holes, etc.), it is recommended to measure Pd on a set board. Exceeding the power dissipation of IC may lead to deterioration of the original IC performance, such as causing operation of the thermal shutdown circuit or reduction in current capability. Therefore, be sure to prepare sufficient margin within power dissipation for usage.

Calculation of the maximum internal power consumption of IC (P_{MAX})

$$P_{MAX} = (V_{IN} - V_{OUT1}) \times I_{OUT1(MAX.)} + (V_{IN} - V_{OUT2}) \times I_{OUT2(MAX.)} + (V_{IN} - V_{OUT3}) \times I_{OUT3(MAX.)}$$

(V_{IN} : Input voltage V_{OUT1,2,3} : Output voltage I_{OUT(MAX)} : Maximum output current)

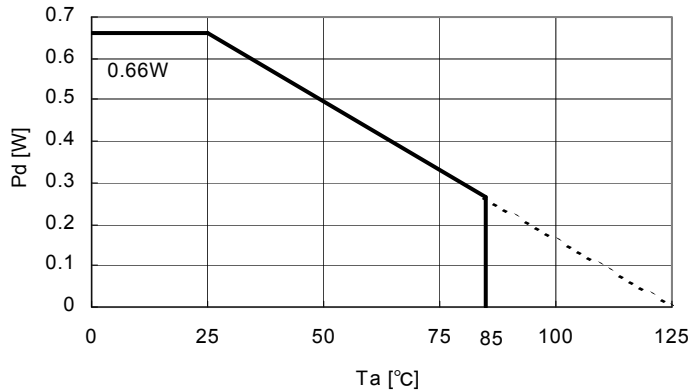

* Please design the margin so that P_{MAX} becomes is than Pd (P_{MAX}<Pd) within the usage temperature range.

- Standard ROHM board -
Size: 70 mm × 70 mm × 1.6 mm
Material : Glass epoxy board

Fig.124 VSON008X2030 Power dissipation heat reduction characteristics (Reference)

●Other notes

- About absolute maximum rating
Breakage may occur when absolute maximum ratings such as applied voltage and operating temperature range are exceeded. Short mode or open mode cannot be specified at occurrence of a break, so please prepare physical safety measures (e.g., fuse) if such special mode in which the absolute maximum rating is exceeded can be assumed.
- About GND potential
Please be sure that the potential of the GND terminal is the lowest in any operating condition.
- About thermal design
Please provide thermal design with sufficient margin, taking power dissipation (Pd) in actual usage conditions into consideration.
- About short between pins and miss-attachment
Please be careful regarding the IC direction and misalignment at attachment onto a printed circuit board. Miss-attachment may cause a break of IC. Short caused by foreign matter between outputs, output and power supply, or GND may also lead to a break.
- About operation in a strong electromagnetic field
Please note that usage in a strong electromagnetic field may cause malfunction.
- About common impedance
Please give due consideration to wiring of the power source and GND by reducing common-mode ripple or making ripple as small as possible (e.g., making the wiring as thick and short as possible, or reducing ripple by L-C), etc.
- About STBY terminal voltage
Set STBY terminal voltage to 0.3 V or less to put each channel into a standby state and to 1.5 V or more to put each channel into an operating state. Do not fix STBY terminal voltage to 0.3 V or more and 1.5 V or less or do not lengthen the transition time. This may cause malfunction or failure.
When shorting the VIN terminal and STBY terminal for usage, the status will be “STBY=VIN=LOW” at turning the power OFF, and discharge of the VOUT terminal cannot operate, which means voltage may remain for a certain time in the VOUT terminal. Since turning the power ON again in this state may cause overshoot, turn the power ON for use after the VOUT terminal is completely discharged.
- About over current protection circuit
Output has a built-in over current protection circuit, which prevents IC break at load short. Note that this protection circuit is effective for prevention of breaks due to unexpected accidents. Please avoid usage by which the protection circuit operates continuously.
- About thermal shutdown
Output is OFF when the thermal circuit operates since a temperature protection circuit is built in to prevent thermal breakdown. However, it recovers when the temperature returns to a certain temperature. The thermal circuit operates at emergency such as overheating of IC. Since it is prepared to prevent IC breakdown, please do not use it in a state in which protection works.
- About reverse current
For applications on which reverse current is assumed to flow into IC, it is recommended to prepare a path to let the current out by putting a bypass diode between the VIN-VOUT terminals.

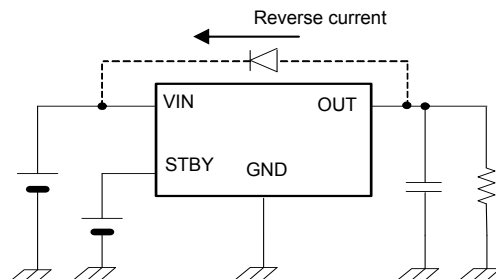

Fig.125 Example of bypass diode connection

- About testing on a set board
When connecting a capacitor to a terminal with low impedance for testing on a set board, please be sure to discharge for each process since IC may be stressed. As a countermeasure against static electricity, prepare grounding in the assembly process and take sufficient care in transportation and storage. In addition, when connecting a capacitor to a jig in a testing process, please do so after turning the power OFF and remove it after turning the power OFF.

● Ordering part number

B	U
---	---

Part No.

6	5	5	0
---	---	---	---

Part No.

6650
6651
6652
6653
6654
6655

N	U	X
---	---	---

Package

NUX: VSON008X2030

T	R
---	---

Packaging and forming specification

TR: Embossed tape and reel

VSON008X2030

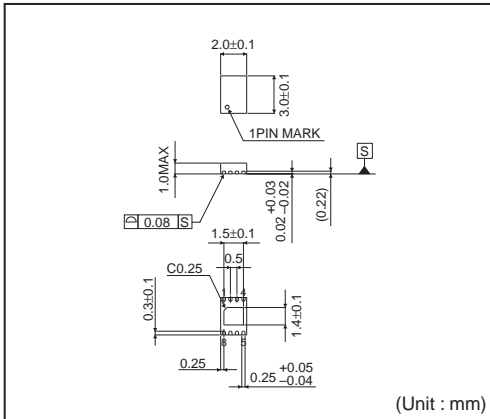

<Tape and Reel information>

Tape	Embossed carrier tape
Quantity	4000pcs
Direction of feed	TR (The direction is the 1pin of product is at the upper right when you hold reel on the left hand and you pull out the tape on the right hand)

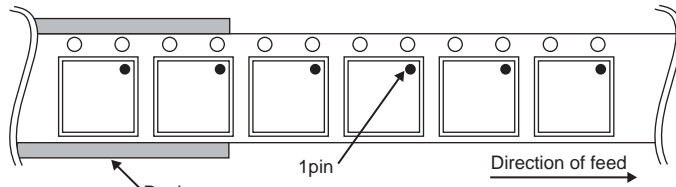

* Order quantity needs to be multiple of the minimum quantity.

Notes

No copying or reproduction of this document, in part or in whole, is permitted without the consent of ROHM Co.,Ltd.

The content specified herein is subject to change for improvement without notice.

The content specified herein is for the purpose of introducing ROHM's products (hereinafter "Products"). If you wish to use any such Product, please be sure to refer to the specifications, which can be obtained from ROHM upon request.

Examples of application circuits, circuit constants and any other information contained herein illustrate the standard usage and operations of the Products. The peripheral conditions must be taken into account when designing circuits for mass production.

Great care was taken in ensuring the accuracy of the information specified in this document. However, should you incur any damage arising from any inaccuracy or misprint of such information, ROHM shall bear no responsibility for such damage.

The technical information specified herein is intended only to show the typical functions of and examples of application circuits for the Products. ROHM does not grant you, explicitly or implicitly, any license to use or exercise intellectual property or other rights held by ROHM and other parties. ROHM shall bear no responsibility whatsoever for any dispute arising from the use of such technical information.

The Products specified in this document are intended to be used with general-use electronic equipment or devices (such as audio visual equipment, office-automation equipment, communication devices, electronic appliances and amusement devices).

The Products specified in this document are not designed to be radiation tolerant.

While ROHM always makes efforts to enhance the quality and reliability of its Products, a Product may fail or malfunction for a variety of reasons.

Please be sure to implement in your equipment using the Products safety measures to guard against the possibility of physical injury, fire or any other damage caused in the event of the failure of any Product, such as derating, redundancy, fire control and fail-safe designs. ROHM shall bear no responsibility whatsoever for your use of any Product outside of the prescribed scope or not in accordance with the instruction manual.

The Products are not designed or manufactured to be used with any equipment, device or system which requires an extremely high level of reliability the failure or malfunction of which may result in a direct threat to human life or create a risk of human injury (such as a medical instrument, transportation equipment, aerospace machinery, nuclear-reactor controller, fuel-controller or other safety device). ROHM shall bear no responsibility in any way for use of any of the Products for the above special purposes. If a Product is intended to be used for any such special purpose, please contact a ROHM sales representative before purchasing.

If you intend to export or ship overseas any Product or technology specified herein that may be controlled under the Foreign Exchange and the Foreign Trade Law, you will be required to obtain a license or permit under the Law.



Thank you for your accessing to ROHM product informations.
More detail product informations and catalogs are available, please contact us.

ROHM Customer Support System

<http://www.rohm.com/contact/>

Компания «Океан Электроники» предлагает заключение долгосрочных отношений при поставках импортных электронных компонентов на взаимовыгодных условиях!

Наши преимущества:

- Поставка оригинальных импортных электронных компонентов напрямую с производств Америки, Европы и Азии, а так же с крупнейших складов мира;
- Широкая линейка поставок активных и пассивных импортных электронных компонентов (более 30 млн. наименований);
- Поставка сложных, дефицитных, либо снятых с производства позиций;
- Оперативные сроки поставки под заказ (от 5 рабочих дней);
- Экспресс доставка в любую точку России;
- Помощь Конструкторского Отдела и консультации квалифицированных инженеров;
- Техническая поддержка проекта, помощь в подборе аналогов, поставка прототипов;
- Поставка электронных компонентов под контролем ВП;
- Система менеджмента качества сертифицирована по Международному стандарту ISO 9001;
- При необходимости вся продукция военного и аэрокосмического назначения проходит испытания и сертификацию в лаборатории (по согласованию с заказчиком);
- Поставка специализированных компонентов военного и аэрокосмического уровня качества (Xilinx, Altera, Analog Devices, Intersil, Interpoint, Microsemi, Actel, Aeroflex, Peregrine, VPT, Syfer, Eurofarad, Texas Instruments, MS Kennedy, Miteq, Cobham, E2V, MA-COM, Hittite, Mini-Circuits, General Dynamics и др.);

Компания «Океан Электроники» является официальным дистрибьютором и эксклюзивным представителем в России одного из крупнейших производителей разъемов военного и аэрокосмического назначения «JONHON», а так же официальным дистрибьютором и эксклюзивным представителем в России производителя высокотехнологичных и надежных решений для передачи СВЧ сигналов «FORSTAR».



JONHON

«JONHON» (основан в 1970 г.)

Разъемы специального, военного и аэрокосмического назначения:

(Применяются в военной, авиационной, аэрокосмической, морской, железнодорожной, горно- и нефтедобывающей отраслях промышленности)

«FORSTAR» (основан в 1998 г.)

ВЧ соединители, коаксиальные кабели, кабельные сборки и микроволновые компоненты:

(Применяются в телекоммуникациях гражданского и специального назначения, в средствах связи, РЛС, а так же военной, авиационной и аэрокосмической отраслях промышленности).



Телефон: 8 (812) 309-75-97 (многоканальный)

Факс: 8 (812) 320-03-32

Электронная почта: ocean@oceanchips.ru

Web: <http://oceanchips.ru/>

Адрес: 198099, г. Санкт-Петербург, ул. Калинина, д. 2, корп. 4, лит. А