

MAX97003 Evaluation Kit

Evaluates: MAX97003

General Description

The MAX97003 evaluation kit (EV kit) is a fully assembled and tested PCB that evaluates the MAX97003 audio subsystem. The device features a mono Class D speaker amplifier and a stereo Class H DirectDrive® headphone amplifier. The EV kit features an on-board microcontroller for communicating with the I²C interface of the device. Pads are provided for accessing the analog inputs and amplifier outputs.

The EV kit requires a 2.7V to 5.5V power supply. The on-board LDO generates an additional 1.8V supply from the USB 5V supply. The EV kit delivers 1W into an 8Ω speaker, and 32mW/channel into a 32Ω headphone.

Windows XP®, Windows Vista®, and Windows® 7-compatible EV kit software is provided to facilitate configuration. The EV kit software controls the on-board microcontroller over USB, which generates I²C commands.

Features

- ◆ 2.7V to 5.5V Single-Supply Operation
- ◆ Proven Audio PCB Layout
- ◆ On-Board USB Interface Circuit Generates I²C-Compatible Signals
- ◆ PCB Pads for User-Supplied I²C-Compatible Signals
- ◆ Surface-Mount Components
- ◆ Windows XP-, Windows Vista-, and Windows 7-Compatible Software
- ◆ Fully Assembled and Tested

Ordering Information appears at end of data sheet.

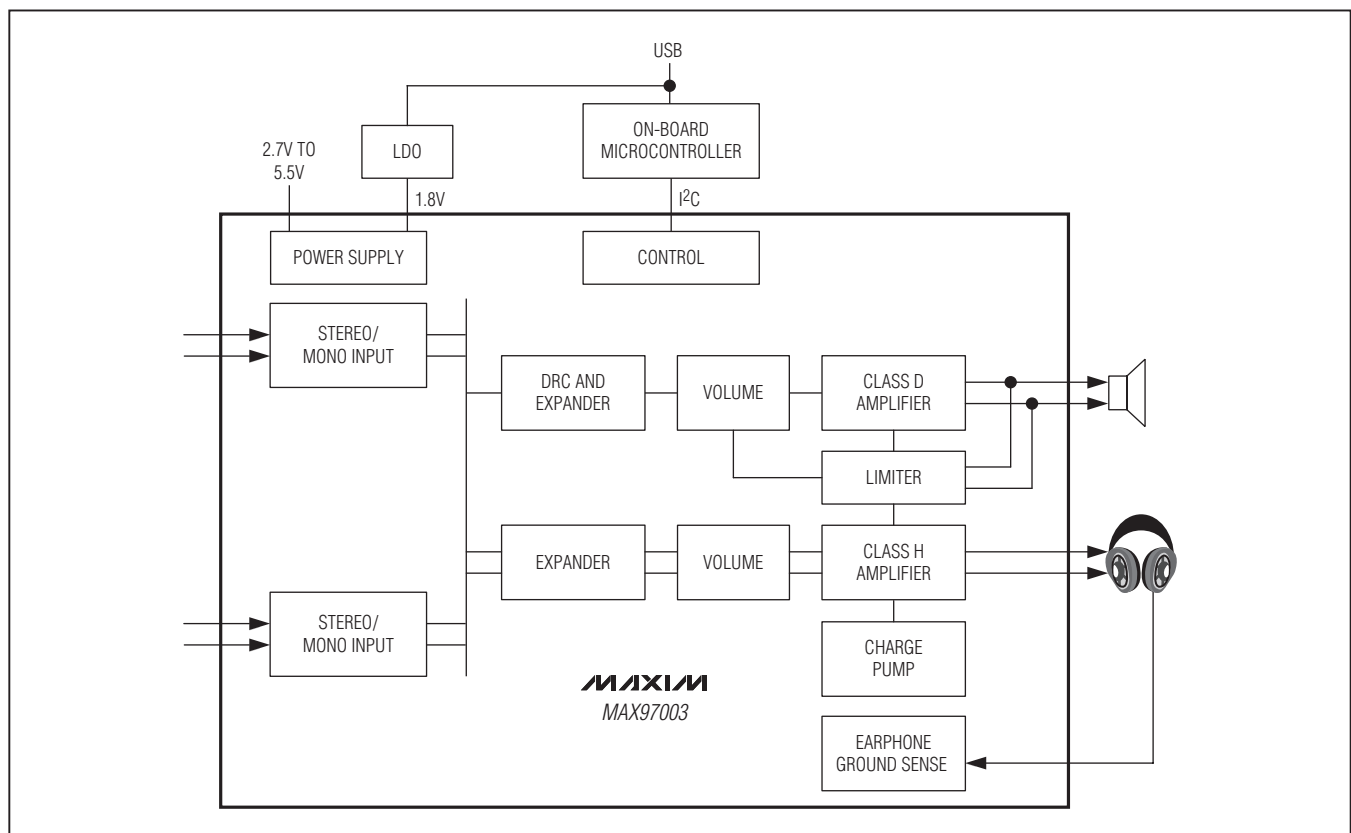

Figure 1. MAX97003 Evaluation Kit Simplified Block Diagram

DirectDrive is a registered trademark of Maxim Integrated Products, Inc.

Windows, Windows XP, and Windows Vista are registered trademarks of Microsoft Corp.

MAX97003 Evaluation Kit

Evaluates: MAX97003

Component List

DESIGNATION	QTY	DESCRIPTION
C1–C8, C114, C123	10	1 μ F \pm 10%, 6.3V X5R ceramic capacitors (0402) Murata GRM155R60J105K
C9, C10, C101, C103–C110, C121	12	0.1 μ F \pm 10%, 6.3V X5R ceramic capacitors (0402) Murata GRM155R60J104K
C11, C12, C102, C113, C115, C122	6	10 μ F \pm 20%, 6.3V X5R ceramic capacitors (0603) Murata GRM188R60J106M
C13–C17	5	0.22 μ F \pm 10%, 6.3V X5R ceramic capacitors (0402) Murata GRM155R60J224K
C18–C25, C117	0	Not installed, capacitors (0402)
C111, C112	2	10pF \pm 5%, 50V C0G ceramic capacitors (0402) Murata GRM1555C1H100J
C116	1	2.2 μ F \pm 20%, 6.3V X5R ceramic capacitor (0402) Murata GRM155R60J225M
C118, C119	2	22pF \pm 5%, 50V C0G ceramic capacitors (0402) Murata GRM1555C1H220J
C120	1	3300pF \pm 10%, 50V X7R ceramic capacitor (0402) Murata GRM155R71H332K
C125, C126	2	0.01 μ F \pm 10%, 16V X7R ceramic capacitors (0402) Murata GRM155R71C103K
D101	1	Green LED (0603)
FB101	0	Not installed, ferrite bead—short (PC trace) (0603)
HPGND, OUT-	2	Black multipurpose test points, 63 mil drill size
HPJK	1	3.5mm, 3-position stereo SMT phone jack (non switch)
JINA1, JINB1	2	Right-angle, PC-mount, white RCA jacks
JINA2, JINB2	2	Right-angle, PC-mount, red RCA jacks
JU1, JU2, JU3	3	2-pin headers
JU4	1	3-pin header
L1, L2	0	Not installed, inductors

DESIGNATION	QTY	DESCRIPTION
OUT+, TPHPR	2	Red multipurpose test points, 63-mill drill size
P101	1	-20V, -2.4A p-channel MOSFET (3 SuperSOT) Fairchild FDN304PZ_NL
R1–R10, R101	11	0 Ω \pm 5% resistors (0402)
R11, R12	2	22 Ω \pm 5% resistors (0402)
R13, R14, R105	3	1.5k Ω \pm 5% resistors (0402)
R102	1	220 Ω \pm 5% resistor (0402)
R103, R104, R109	0	Not installed, resistors (0402)
R106, R107	2	27 Ω \pm 5% resistors (0402)
R108	1	1k Ω \pm 5% resistor (0402)
TPHPL	1	White multipurpose test point, 63-mill drill size
U1	1	Audio subsystem with I ² C (20 WLP) Maxim MAX97003EWP+
U101	1	32-bit microcontroller (68 QFN-EP) Maxim MAXQ2000-RAX+
U102	0	Not installed, EEPROM (8 SO)
U103	1	UART-to-USB converter (32 TQFP)
U104	1	3.3V, 120mA regulator (5 SC70) Maxim MAX8511EXK33+T
U105	1	2.5V, 120mA regulator (5 SC70) Maxim MAX8510EXK25+T
U106	1	1.8V, 300mA regulator (5 SOT23) Maxim MAX8887EZK18+T
USB	1	USB mini-B receptacle
Y101	1	16MHz crystal Hong Kong X'tals SSM16000N1HK188F0-0
Y102	1	6MHz crystal Hong Kong X'tals SSL60000N1HK188F0-0
—	1	USB high-speed A-to-mini-B cable
—	4	Shunts
—	1	PCB: MAX97003 EVALUATION KIT

MAX97003 Evaluation Kit

Evaluates: MAX97003

Component Suppliers

SUPPLIER	PHONE	WEBSITE
Fairchild Semiconductor	888-522-5372	www.fairchildsemi.com
Hong Kong X'tals Ltd.	852-35112388	www.hongkongcrystal.com
Murata Electronics North America, Inc.	770-436-1300	www.murata-northamerica.com

Note: Indicate that you are using the MAX97003 when contacting these component suppliers.

Quick Start

Recommended Equipment

- MAX97003 EV kit (USB cable included)
- 5V, 1A DC power supply (PVDD)
- Speaker
- Headphones
- User-supplied Windows XP, Windows Vista, or Windows 7 PC with an available USB port

Note: In the following sections, software-related items are identified by bolding. Text in **bold** refers to items directly from the EV kit software. Text in **bold and underlined** refers to items from the Windows operating system.

Procedure

The EV kit is fully assembled and tested. Follow the steps below to verify board operation. **Caution: Do not turn on the power supply until all connections are completed.**

- 1) Visit <http://www.maxim-ic.com/evkitsoftware> to download the latest version of the EV kit software, 97003Rxx.ZIP. Save the EV kit software to a temporary folder and uncompress the ZIP file.
- 2) Install the EV kit software on your computer by running the INSTALL.EXE program inside the temporary folder. The program files are copied and icons are created in the Windows **Start | Programs | Maxim EVKIT Software** menu.
- 3) Verify that all jumpers are in their default positions, as shown in Table 1.
- 4) Connect the power supply between the PVDD and PGND PCB pads.
- 5) Set the power supply to 4.2V and turn it on.
- 6) Apply a stereo single-ended audio signal to INA1 and INA2.
- 7) Connect a speaker between the OUT+ and OUT- test points.
- 8) Connect a headphone to HPJK.
- 9) Connect a USB cable between the PC and the Mini-USB port on the EV kit. A **New Hardware Found** window pops up when installing the USB driver for the first time. If a window is not seen that is similar to the one described above after 30s, remove the USB cable from the board and reconnect it. Administrator privileges are required to install the USB device driver on Windows.
- 10) Follow the directions in the **Found New Hardware** window to install the USB device driver. Refer to the USB_Driver_Help_200.PDF document included with the software for additional information.
- 11) Start the EV kit software by opening its icon in the **Start | Programs | Maxim EVKIT Software** menu. The EV kit software main window appears, as shown in Figure 2.
- 12) Wait while the software connects to the EV kit. Once the connection is established, the status bar at the bottom displays **Hardware: Connected** and **Device Found**.
- 13) Once the EV kit software has initialized, select the **Control Panel** tab.
- 14) Click on the **Input A** drop-down menu in the **Input PreAmp Gain** group box and select **0dB**.
- 15) Check the **INA1** checkbox in the **HPL Mixer** group box and the **INA2** checkbox in the **HPR Mixer** group box.
- 16) Check the **HPL Enable** and **HPR Enable** checkboxes.
- 17) Check the **Lock L&R HP Vol** checkbox to force the left and right output volume to match.
- 18) Drag either horizontal slider in the **Headphone Amplifiers** group box to **Max**.
- 19) Check the **INA1** and **INA2** checkboxes in the **SPK Mixer** group box.
- 20) Check the **SPK Enable** checkbox.
- 21) Drag the horizontal slider in the **Speaker Amplifier** group box to **Max**.
- 22) Check the **Enabled** checkbox in the **MAX97003 Master Controls** group box. Audio is output to both the headphone and speaker.

MAX97003 Evaluation Kit

Evaluates: MAX97003

Detailed Description of Software

Graphical User Interface (GUI)

The MAX97003 EV kit software GUI provides a convenient way to test the features of the MAX97003. Figure 2 displays the EV kit software's Control Panel tab sheet, while Figure 3 displays the Control Registers tab sheet. Actions on either of these two tabs generate I²C commands to update the device's internal memory registers.

The EV kit software Control Panel tab sheet divides the EV kit functions into logical blocks. The EV kit software Control Registers tab sheet displays each register's individual bit logic-level status. A data bit in bold indicates a logic-high, while a data bit that is not bold indicates a logic-low. Clicking on the individual data bit toggles the bit and performs a write command. The new command is shown in the edit box at the right. Alternatively, write commands can be written to the registers by typing a hex value in the edit box and pressing the Enter key on the keyboard.

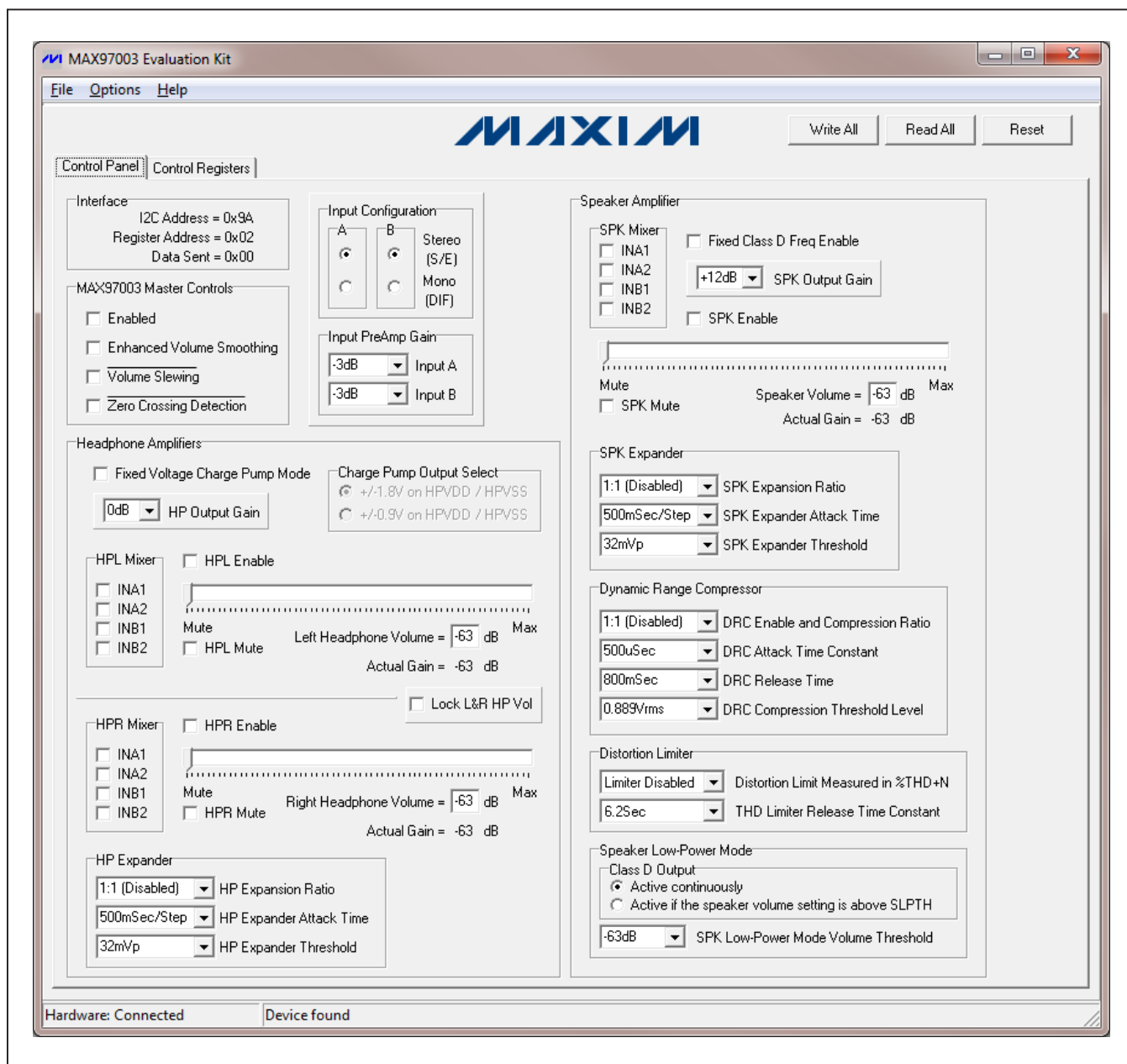

Figure 2. MAX97003 EV Kit Software Main Window (Control Panel Tab)

MAX97003 Evaluation Kit

Evaluates: MAX97003

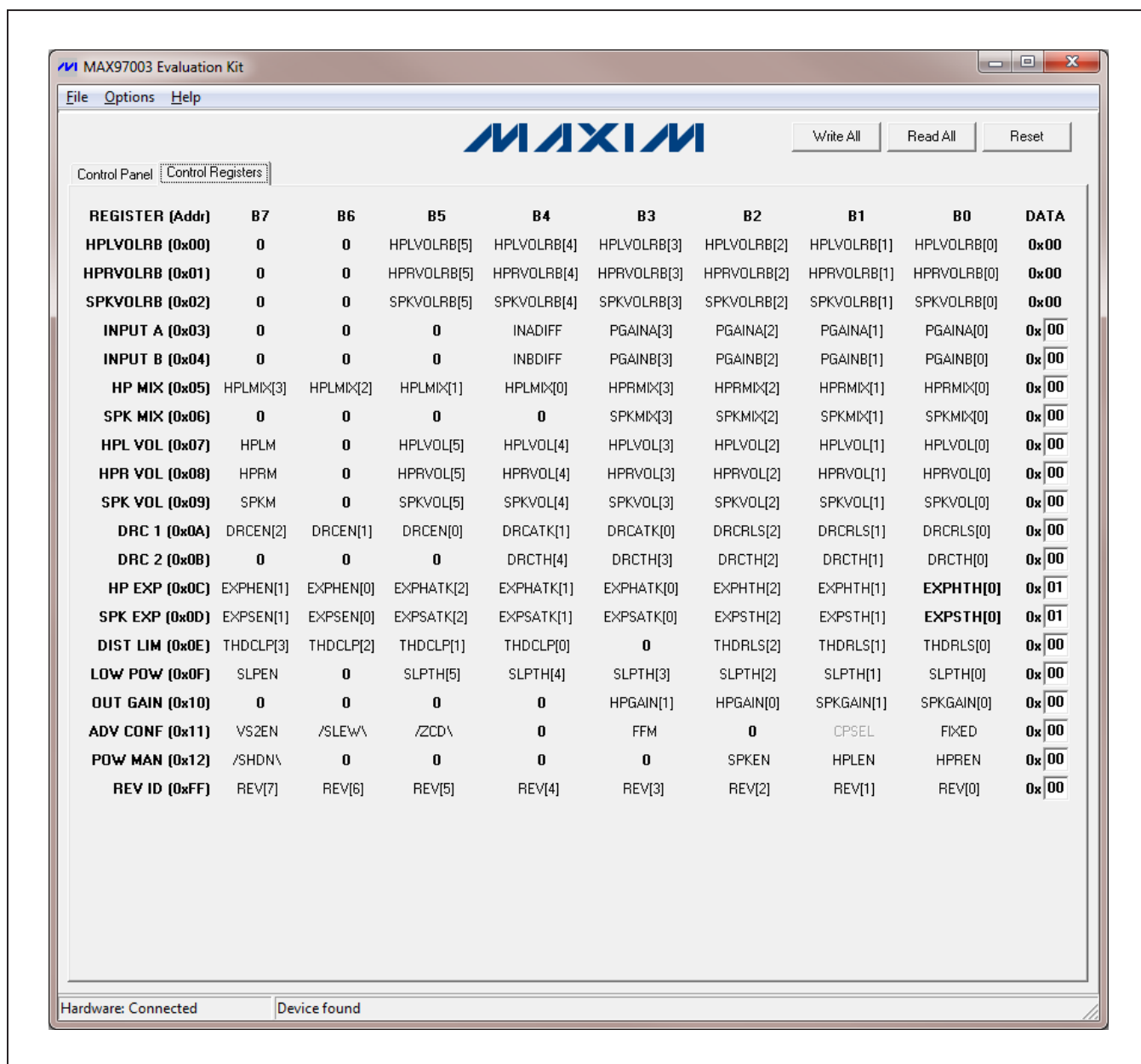

Figure 3. MAX97003 EV Kit Software Main Window (Control Registers Tab)

MAX97003 Evaluation Kit

Evaluates: MAX97003

Software Startup

Upon starting the program, the EV kit software automatically searches for the USB interface circuit and then for the IC device address. The EV kit enters the normal operating mode when the USB connection is detected and has found the device address. The **Enabled** checkbox in the **Control Panel** tab sheet enables the device operation. If the USB connection is not detected, the software prompts the user to retry or enter the demo mode.

Demo Mode

The EV kit software enters the demo mode when the USB connection is not detected, or by selecting the **Options | Demo Mode** menu item in the main window. When in demo mode, all software communication to the EV kit circuit is disabled; however, most of the software GUI is functional. Demo mode allows the user to evaluate the software without hardware connectivity. If the USB cable is connected to the EV kit, but power is not applied to PVDD, the EV kit GUI acts like it is in demo mode. In such a case, the EV kit is connected to the PC through the USB, and I²C commands can be sent to the device. However, without power, the device does not acknowledge the I²C commands. When power is applied, press the **Reset** button to detect the presence of the device.

Write All/Read All/Reset

The **Write All** button writes the current settings to all the registers on the GUI. The EV kit software GUI performs I²C write commands as changes occur on the GUI. The **Read All** button changes the GUI settings to match the device register settings. To change settings one time, enter demo mode by selecting the **Options | Demo Mode** menu item, change the GUI to the required settings, exit demo mode by selecting **Options | Demo Mode**, and then press the **Write All** button. To obtain the device settings, press the **Read All** button and the GUI is updated to reflect the current register states of the device. In addition, the EV kit software can be set to automatically read back the device registers every 1s by selecting the **Options | Auto I²C Read** menu item. The **Reset** button clears the EV kit software GUI and reprograms the device to the default values.

I²C Interface

The EV kit software **Interface** group box displays the device's **I²C Device Address**, **Register Address**, and the last **Data Sent**. The MAX97003's I²C device address is internally set to 0x9A.

MAX97003 Master Controls

The EV kit software **MAX97003 Master Controls** group box provides checkboxes to control the device's **Enabled**, **Enhanced Volume Smoothing**, **Volume Slewing**, and **Zero Crossing Detection**.

Input Configuration/Input PreAmp Gain

The **Input Configuration** group box configures the device's input channels **A** and **B** for **Stereo** (single-ended) or **Mono** (differential). The **Input PreAmp Gain** group box selects the gain values for the input channels. The input preamp gains range from -3dB to +12dB in 1.5dB steps.

Headphone Amplifiers

The **Headphone Amplifiers** group box configures the device's headphone power supply, headphone output gain, input channel selection, enables, mutes, volume controls, and expander settings. The **Fixed Voltage Charge Pump Mode** checkbox selects between Class H and fixed supply mode to power the headphones. When the **Fixed Voltage Charge Pump Mode** checkbox is checked, the **Charge Pump Output Select** radio group box is enabled, allowing HPVDD/HPVSS to be set to either $\pm 1.8V$ or $\pm 0.9V$. The **HP Output Gain** ranges from 0dB to 6dB in 2dB steps. The **HPL Mixer** and **HPR Mixer** group boxes select the input channels to the headphone amplifiers. There are four input channels (**INA1**, **INA2**, **INB1**, and **INB2**) that can be connected into each headphone amplifier. The **HP Expander** group box configures the **HP Expansion Ratio**, **HP Expander Attack Time**, and **HP Expander Threshold**. The **Lock L&R HP Vol** checkbox locks the **Right Headphone Volume** track bar/edit box to the **Left Headphone Volume** track bar/edit box when it is checked.

Speaker Amplifier

The **Speaker Amplifier** group box configures the device's speaker output modulation, output gain, input channel selection, enable, mute, volume control, expander, dynamic range compressor, distortion limiter settings, and the speaker low-power mode. The **Fixed Class D Freq Enable** checkbox selects between spread-spectrum and fixed-frequency modulation for the speaker output. The **SPK Output Gain** ranges from +12dB to +24dB in 4dB steps. The **SPK Mixer** group box selects the input channels to the speaker amplifier. There are four input channels (**INA1**, **INA2**, **INB1**, and **INB2**) that can be connected into the speaker amplifier. The **SPK Expander** group box configures the **SPK Expansion Ratio**, **SPK Expander Attack Time**, and **SPK Expander Threshold**. The **Dynamic Range Compressor (DRC)** group box configures the **DRC Enable** and **Compression Ratio**, **DRC Attack Time Constant**, **DRC Release Time**, and **DRC Compression Threshold Level**. The **Distortion Limiter** group box is enabled when the **Zero Crossing Detection** checkbox is unchecked. The **Speaker Low-Power Mode** group box sets the **SPK Low-Power Mode Volume Threshold** and selects the Class D output mode. The Class D Output is selectable between **Active continuously** or **Active if the speaker volume setting is above SLPTH** (speaker low-power threshold).

MAX97003 Evaluation Kit

Evaluates: MAX97003

Simple I²C Commands

There are three methods for communicating with the EV kit, through the **Control Panel** tab sheet, the **Control Registers** tab sheet, or by using low-level SMBus commands available in the **Advanced User Interface** win-

dow (Figure 4). Select **Options | Interface (Advanced Users)** to display the **Advanced User Interface** window, which allows I²C operations such as **SMBusReadByte** and **SMBusWriteByte**.

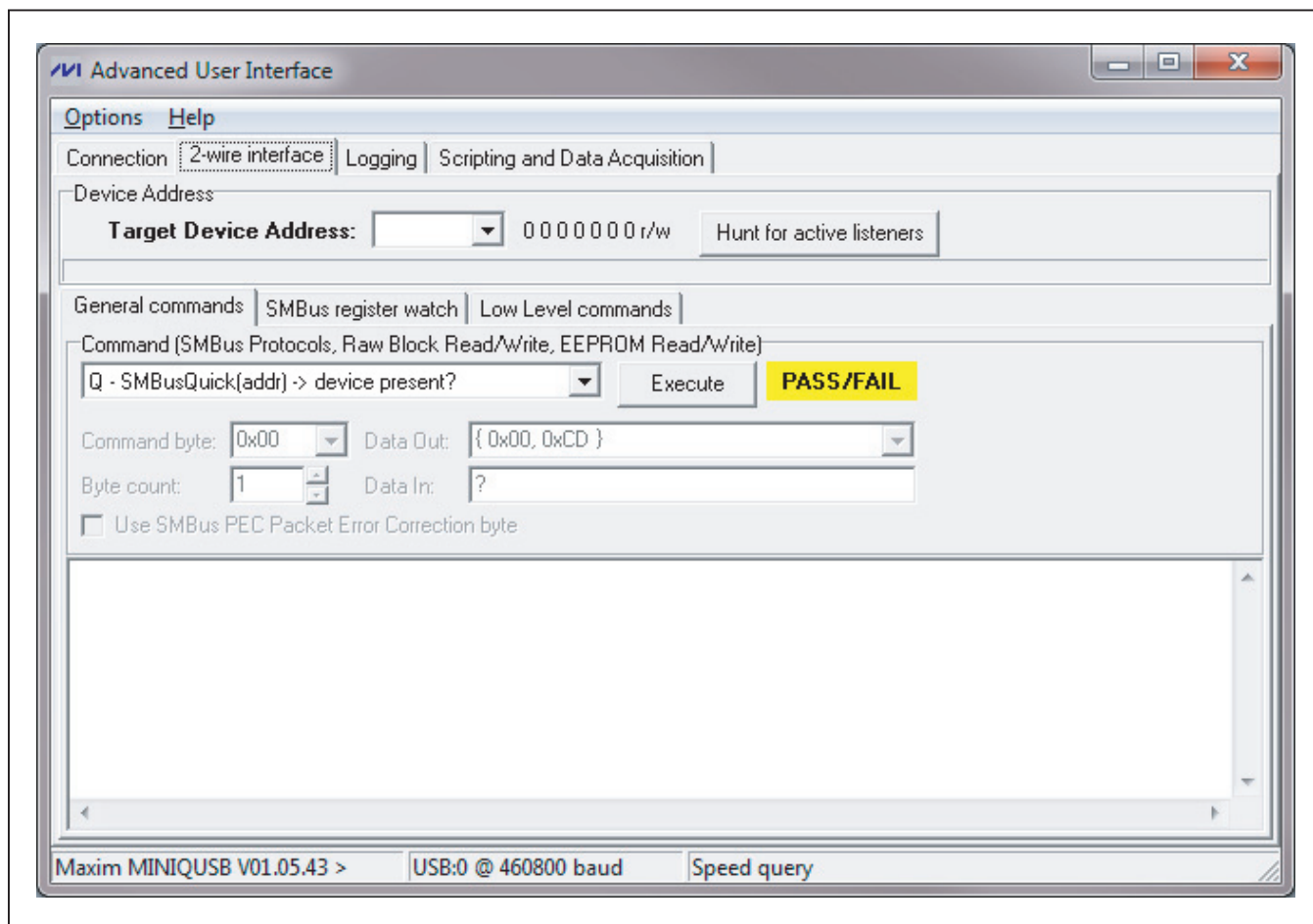

Figure 4. MAX97003 EV Kit Software (Advanced User Interface)

MAX97003 Evaluation Kit

Evaluates: MAX97003

Detailed Description of Hardware

The MAX97003 EV kit evaluates the MAX97003 Class D audio amplifier and stereo DirectDrive Class H headphone amplifier, which communicates over I²C. The EV kit demonstrates the device features such as user-defined input configuration, input gain, input source, output enable, and volume control. The EV kit uses the device in a 20-bump (2.4mm x 2mm) wafer-level package (WLP) on a proven six-layer PCB design. The EV kit operates from a 2.7V to 5.5V and 1.8V DC power supply. The EV kit delivers 1W into an 8Ω speaker and 32mW/channel into a 32Ω headphone.

Filterless Output

The EV kit's filterless outputs (OUT+, OUT-) can be connected directly to a speaker load without any filtering. Use the OUT+ and OUT- test points to connect the speaker directly to the device outputs using a twisted-pair cable. Do not install inductors L1 and L2 for maximum efficiency.

Filtered Output

Audio analyzers typically cannot accept pulse-width modulated (PWM) signals at their inputs. Therefore, the EV kit includes a pair of lowpass filters at the output to ease evaluation. To use the filtering output pads (FOUT+, FOUT-), install inductors L1 and L2 (provided with the EV kit), connect the load between FOUT+ and FOUT-, and connect the filtered output to the audio analyzer. The lowpass filters at the speaker outputs are optimized for an 8Ω speaker.

Table 1. Default Shunt Positions (Ju1–Ju4)

JUMPER	SHUNT POSITION	DESCRIPTION
JU1	Closed*	On-board I ² C. Connects the on-board SCL signal to the SCL PCB pad.
	Open	User-supplied I ² C. Open the jumper and apply the SCL signal to the SCL PCB pad.
JU2	Closed*	On-board I ² C. Connects the on-board SDA signal to the SDA PCB pad.
	Open	User-supplied I ² C. Open the jumper and apply the SDA signal to the SDA PCB pad.
JU3	Closed*	On-board VDD supply. Connects an on-board LDO, outputting 1.8V to the VDD PCB pad.
	Open	External VDD supply. Externally supply VDD with 1.8V.
JU4	1-2*	On-board I ² C. Connects the on-board I ² C pullup resistors to 3.3V.
	2-3	User-supplied I ² C. Connect the external I ² C master's logic voltage to the VI2C PCB pad.

*Default position.

MAX97003 Evaluation Kit

Evaluates: MAX97003

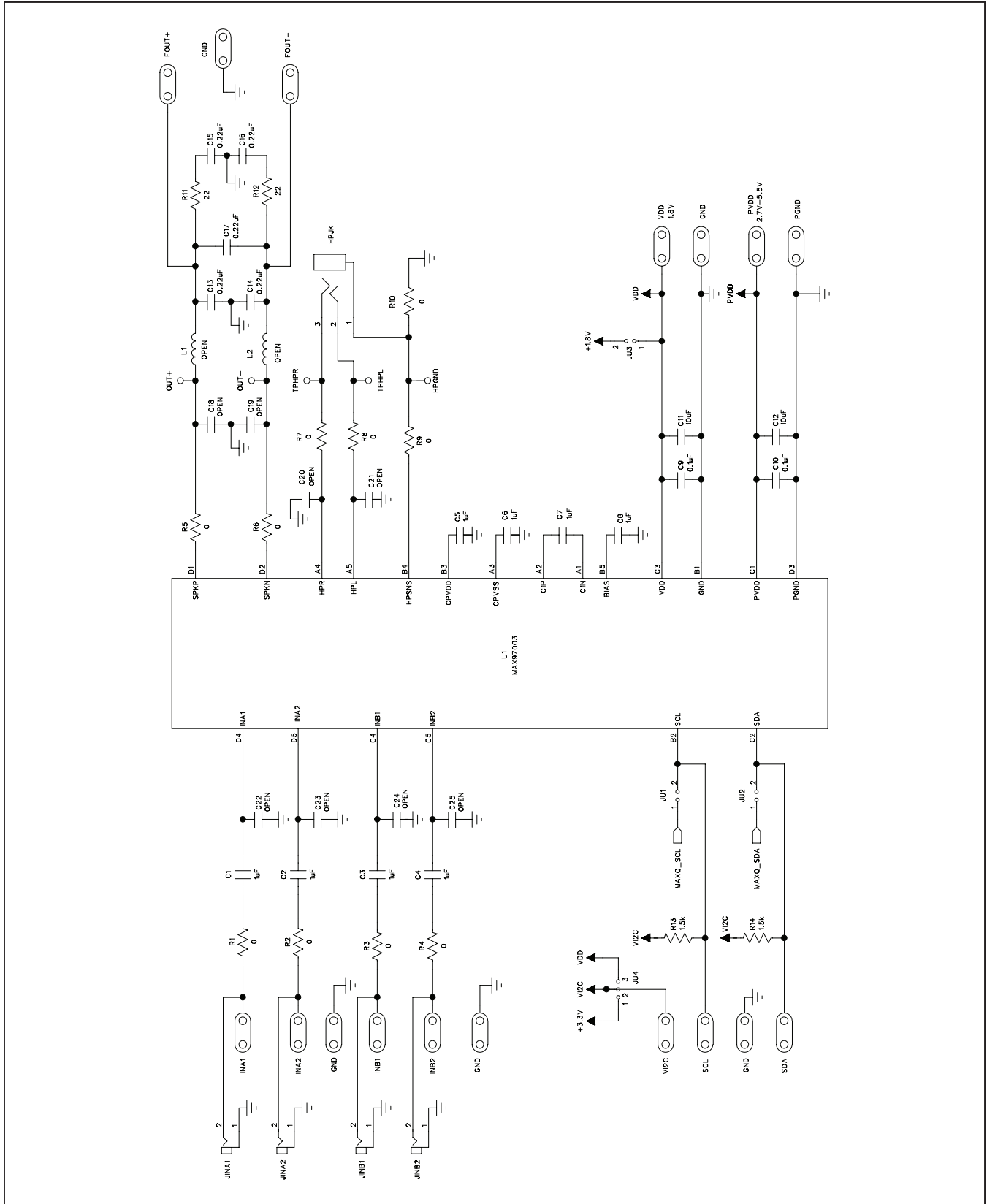

Figure 5a. MAX97003 EV Kit Schematic (Sheet 1 of 2)

MAX97003 Evaluation Kit

Evaluates: MAX97003

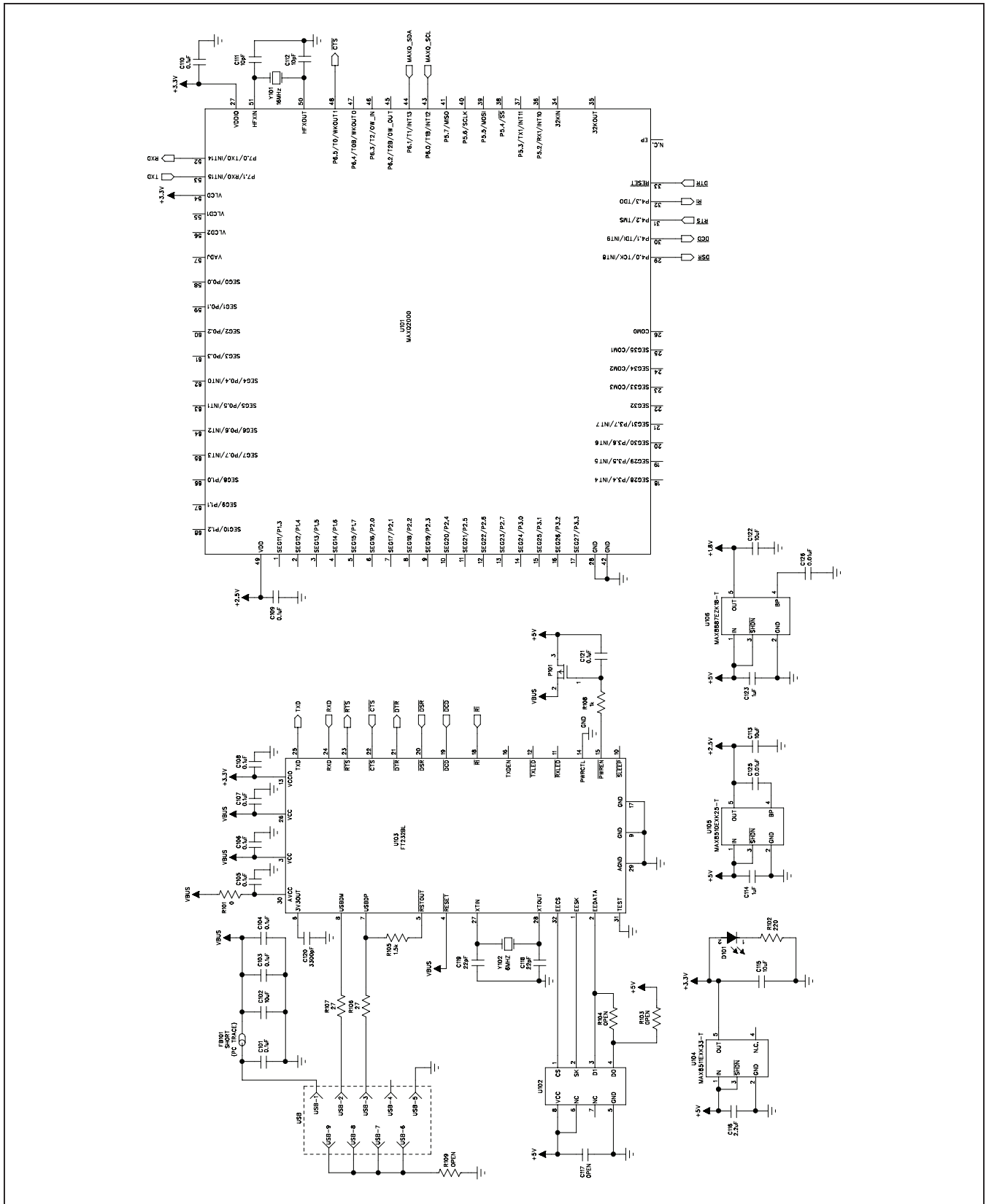

Figure 5b. MAX97003 EV Kit Schematic (Sheet 2 of 2)

MAX97003 Evaluation Kit

Evaluates: MAX97003

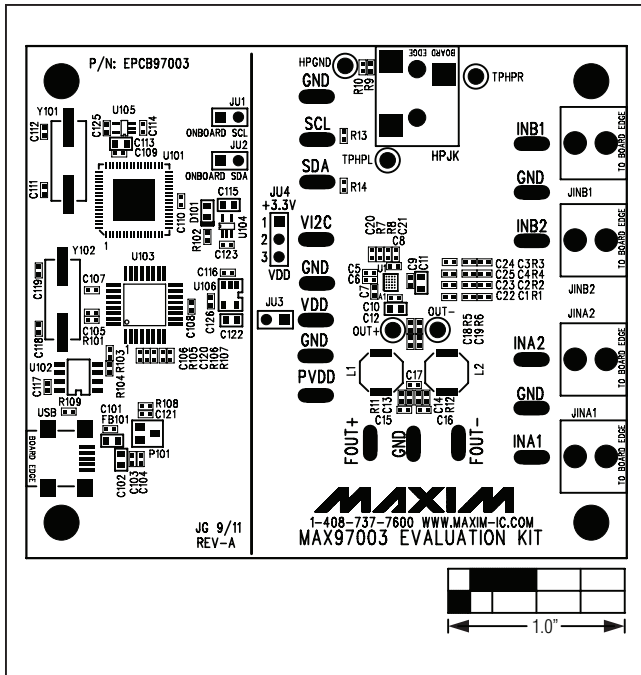

Figure 6. MAX97003 EV Kit Component Placement Guide—Component Side

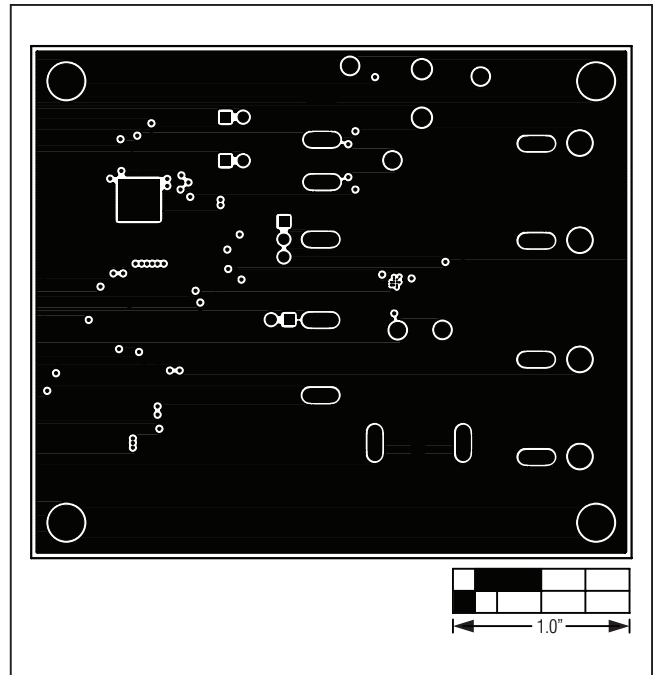

Figure 8. MAX97003 EV Kit PCB Layout—GND Layer 2

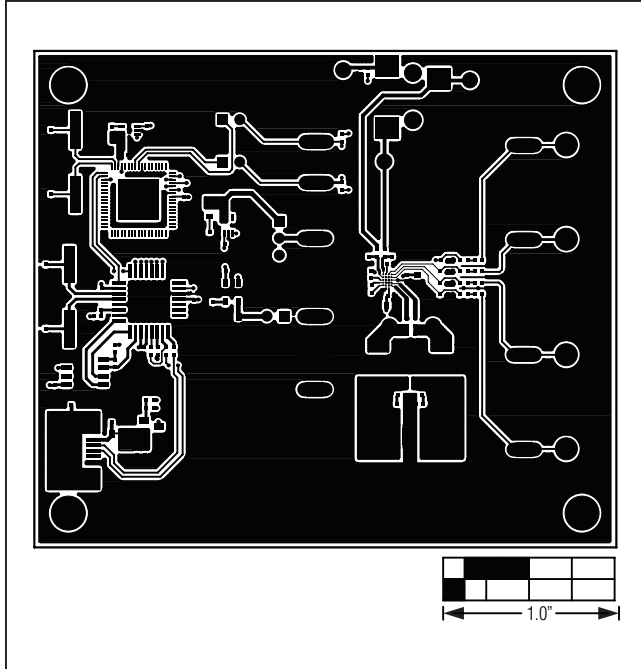

Figure 7. MAX97003 EV Kit PC Board Layout—Component Side

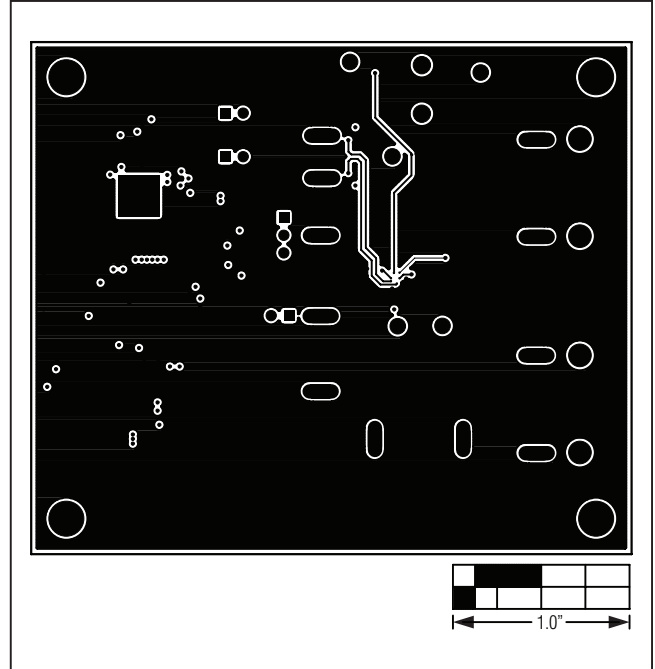

Figure 9. MAX97003 EV Kit PCB Layout—GND Layer 3

MAX97003 Evaluation Kit

Evaluates: MAX97003

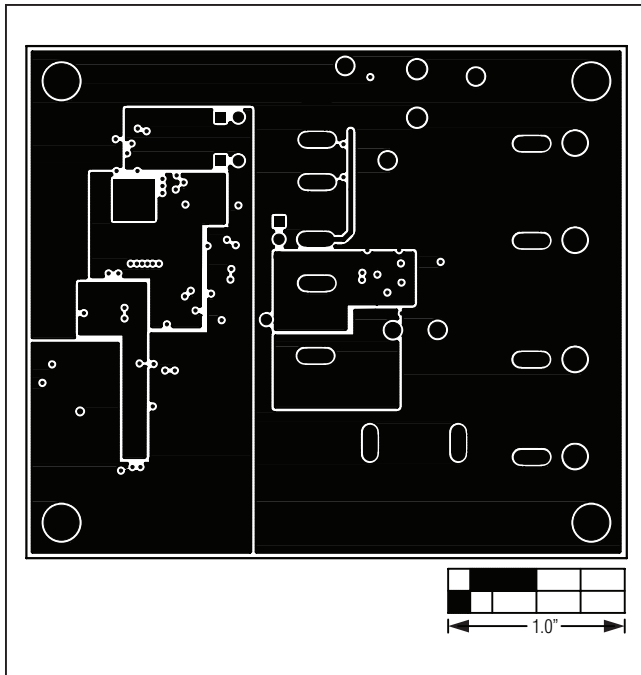

Figure 10. MAX97003 EV Kit PCB Layout—PWR Layer 4

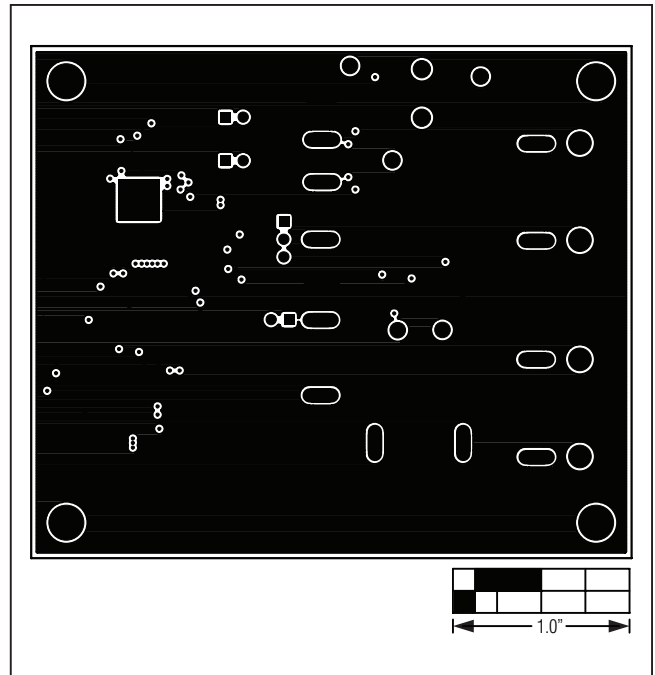

Figure 11. MAX97003 EV Kit PCB Layout—GND Layer 5

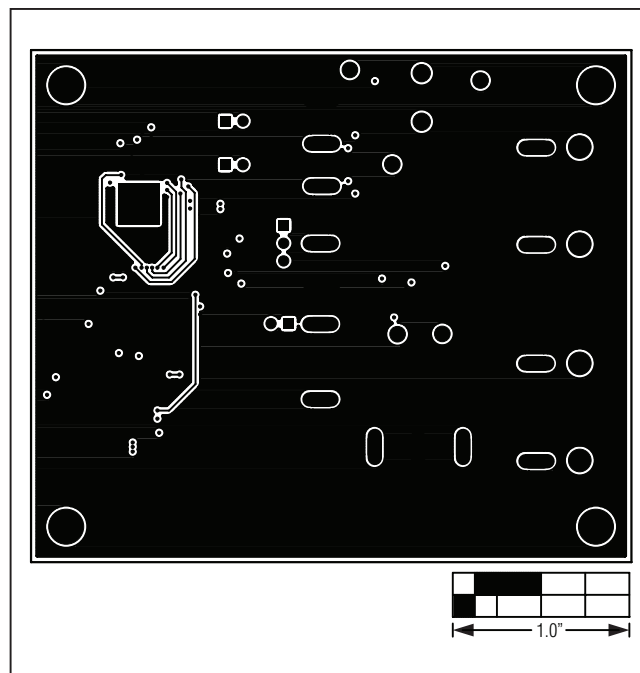

Figure 12. MAX97003 EV Kit PCB Layout—Solder Side

MAX97003 Evaluation Kit

Evaluates: MAX97003

Ordering Information

PART	TYPE
MAX97003EVKIT#	EV Kit

#Denotes RoHS compliant.

MAX97003 Evaluation Kit

Evaluates: MAX97003

Revision History

REVISION NUMBER	REVISION DATE	DESCRIPTION	PAGES CHANGED
0	2/12	Initial release	—

Maxim cannot assume responsibility for use of any circuitry other than circuitry entirely embodied in a Maxim product. No circuit patent licenses are implied. Maxim reserves the right to change the circuitry and specifications without notice at any time.

Maxim Integrated Products, 120 San Gabriel Drive, Sunnyvale, CA 94086 408-737-7600 _____ 14

Компания «Океан Электроники» предлагает заключение долгосрочных отношений при поставках импортных электронных компонентов на взаимовыгодных условиях!

Наши преимущества:

- Поставка оригинальных импортных электронных компонентов напрямую с производств Америки, Европы и Азии, а так же с крупнейших складов мира;
- Широкая линейка поставок активных и пассивных импортных электронных компонентов (более 30 млн. наименований);
- Поставка сложных, дефицитных, либо снятых с производства позиций;
- Оперативные сроки поставки под заказ (от 5 рабочих дней);
- Экспресс доставка в любую точку России;
- Помощь Конструкторского Отдела и консультации квалифицированных инженеров;
- Техническая поддержка проекта, помощь в подборе аналогов, поставка прототипов;
- Поставка электронных компонентов под контролем ВП;
- Система менеджмента качества сертифицирована по Международному стандарту ISO 9001;
- При необходимости вся продукция военного и аэрокосмического назначения проходит испытания и сертификацию в лаборатории (по согласованию с заказчиком);
- Поставка специализированных компонентов военного и аэрокосмического уровня качества (Xilinx, Altera, Analog Devices, Intersil, Interpoint, Microsemi, Actel, Aeroflex, Peregrine, VPT, Syfer, Eurofarad, Texas Instruments, MS Kennedy, Miteq, Cobham, E2V, MA-COM, Hittite, Mini-Circuits, General Dynamics и др.);

Компания «Океан Электроники» является официальным дистрибьютором и эксклюзивным представителем в России одного из крупнейших производителей разъемов военного и аэрокосмического назначения «JONHON», а так же официальным дистрибьютором и эксклюзивным представителем в России производителя высокотехнологичных и надежных решений для передачи СВЧ сигналов «FORSTAR».



JONHON

«JONHON» (основан в 1970 г.)

Разъемы специального, военного и аэрокосмического назначения:

(Применяются в военной, авиационной, аэрокосмической, морской, железнодорожной, горно- и нефтедобывающей отраслях промышленности)

«FORSTAR» (основан в 1998 г.)

ВЧ соединители, коаксиальные кабели, кабельные сборки и микроволновые компоненты:

(Применяются в телекоммуникациях гражданского и специального назначения, в средствах связи, РЛС, а так же военной, авиационной и аэрокосмической отраслях промышленности).



Телефон: 8 (812) 309-75-97 (многоканальный)

Факс: 8 (812) 320-03-32

Электронная почта: ocean@oceanchips.ru

Web: <http://oceanchips.ru/>

Адрес: 198099, г. Санкт-Петербург, ул. Калинина, д. 2, корп. 4, лит. А